





621.05  
R15



VOLUME TWENTY-ONE.

---

From January to December, 1898, Inclusive.

---

# Railway Master Mechanic.

Devoted to Railway Motive Power, Car Equipment, Shops, Machinery and Supplies.

---

EDWIN N. LEWIS, Manager Business Department.

WALTER D. CROSMAN, Manager Editorial Department.

---

Published by The Railway List Company.

315 DEARBORN ST., CHICAGO.

# INDEX TO CONTENTS.

Articles Marked with an Asterisk are Illustrated.

## EDITORIAL.

Air, compressed, in shops.....	1
Air admission to fire boxes.....	1
Air hoist, the first.....	89
Arthur, P. M., on labor organizations.....	43
Ash pans, locomotive.....	163
Associations, M. C. B. and M. M., consolidation of.....	89
Assumption of risks by employes.....	29
Banquet of manufacturers.....	15
Bearing linings.....	149
Bearing metals, journal.....	57
Boiler and cylinder coverings.....	17
Boiler covering tests.....	149
Bolster loads.....	29
Bolts, taper, design of.....	15
Brake shoe tests.....	30
Brake system, drafts upon.....	149
Brake tests.....	30-89
Brakes, air, on the Lake St. "L".....	29
Braking trains partially equipped with air.....	2
Bridge and building superintendents' work.....	1
Boxes, hot.....	29
Burnishing wearing surfaces.....	29
Cab fittings.....	135
Car builder, master, the passing of the title of.....	15
Car construction for a year.....	71
Car design, passenger.....	163
Car Foremen's Association, the Chicago.....	103-119
Car framing, steel.....	39
Cars, large.....	72
Circulars of inquiry.....	163
Club work.....	1-15
Combustion in locomotive fire boxes.....	1
Committee work.....	163
Compound and simple locomotives.....	43
Compound locomotives.....	71-119
Conventions, does it pay to exhibit at?.....	58
Convention, the M. C. B., work of.....	30
Convention, the Master Mechanics, the work of.....	16
Conventions, the work of.....	89
Couplers, automatic, number of.....	43
Coupler, the M. C. B.....	30-43-44-57-90-119-135-149
Couplers, M. C. B., knuckle breakages.....	149
Coupler, the M. C. B., notes on.....	149
Couplers, M. C. B., pilot.....	57
*Coupler, the M. C. B., strengthening.....	135
Couplers, M. C. B., the number of.....	119
Couplers, M. C. B., weights of.....	119
Cylinder fastenings.....	17
Designs, mechanical, adaptation of.....	15
Drawbars, variation in height of.....	71
Duty to inspect foreign cars.....	164
Electricity in shops.....	1-57
Employers and employes, relative rights and duties of touching appliances.....	150
Engineers bound to discover patent defects before starting.....	58
Entertainment at the conventions.....	89
Excursions to industrial works.....	1
Exhaust steam for feed water heating.....	149, 163
Exhibits at the conventions.....	58
Expense accounts.....	103
Feed water heating.....	149, 163
Firemen, locomotive, duties of.....	135
Firemen, the promotion of.....	120
Fuel consumption in locomotive tests, measuring.....	149
Fuel economy.....	72
Gages, steam.....	15
Graphic chart records.....	29
Handling trains partially equipped with air.....	2
Hiring locomotive runners.....	120
Hot box reports.....	29
Hydraulic pumps and presses in shops.....	1
Injectors, the working of.....	15
Inspection of foreign cars, the legal duty of railways.....	164
Inspection of railway supplies.....	163
Journal hearing linings.....	149
Journal bearing metals.....	57
Journal boxes, oiling.....	104
Labor, organized.....	43
Labor and machinery in England.....	15
Laboratory, testing, a proposed joint.....	103

Legal decisions.....	58
Legal decisions—employe must prove ignorance of defects or employers' promise to remedy them.....	104
Links and pins, breakage of.....	43
Locomotive progress.....	71
Locomotive steam gages.....	15
Locomotive tests, measuring fuel consumption in.....	149
Locomotives, compound.....	119
Locomotives, compound and simple.....	43
Locomotives, heavy, comparative traction power of.....	16
Lubricators, responsibility for condition of.....	136
Machinery as affecting labor.....	15
Master Car Builders' Association, the work before.....	30
Master Mechanics, the work ahead for the.....	16
Measuring fuel consumption in locomotive tests.....	149
Military railroading.....	119
Noon hour talks.....	89
Oil testing machine.....	71
Oiling journal boxes.....	104
Passenger car construction.....	71
Patent decision, an important.....	58
Pilots, locomotive.....	57
Piston valves, some points about.....	16
Purchase of railway supplies.....	163
Purchase of supplies.....	90
Records, graphic.....	29
Responsibility for condition of automatic lubricators.....	136
Reviving old designs.....	163
Rights and duties of employers and employes touching appliances.....	150
Risks, assumption of by employes.....	29
Rolling wearing surfaces.....	29
Rules, reasonableness of a question of law.....	58
Runners, locomotive, the hiring of.....	120
Salt drippings.....	30
Scholarships, Master Mechanics'.....	57
Side bearings.....	29
Sinclair, Robert.....	163
Standardizing locomotive parts.....	1
Station agents can assume brakes are all right.....	58
Steel car framing.....	30
Steel, high grade.....	43
Stokers, automatic, on locomotives.....	1
*Strengthening the M. C. B. coupler.....	135
Strike in England, the great.....	2-15
Supplies, the purchase and inspection of.....	163
Supplies, the purchase of.....	90
Taper bolt design.....	15
Testing laboratory, a proposed joint.....	103
Tests, locomotive, measuring fuel consumption in.....	149
Tonnage rating for locomotives.....	16-89
Tools for railway shops.....	16
Traction power of some heavy locomotives, comparative.....	16
Trains parting.....	163
Traveling engineers, the duties of.....	135
Trial orders.....	90
Trucks, freight.....	30
Trucks, metal, the rigidity of.....	90
Trucks, special metal.....	90
Valves, piston, some points about.....	16
Water pressure apparatus and air brakes.....	149
Wheel and track gages.....	30
Wheel tests, thermal.....	30

## MISCELLANEOUS.

Accounts, improved methods of keeping mileage, oil waste and fuel.....	40
Air brake practice, Kidder's paper.....	159
Air gage, the semaphore.....	51
*Air resistance to the motion of railway trains, Goss' paper.....	87-110
*Air valve for track sanding, the Curtis.....	158
Analysis of boiler waters.....	150
Annealing, dangers in.....	21-41
Apprentice boys, action of M. M. Assn.....	93
Arbitration case No. 502.....	172
Arbitration case 513.....	146
Associations, M. C. B. and M. M., consolidating of.....	162, 173
Associations, mechanical, consolidation of, action of M. M. Association.....	93
*Axle gage, Fildes'.....	142

Axle tests, New York Car Wheel Works.....	28
*Baggage handler, pneumatic.....	171
*Ballast unloader, Northern Pacific R. R.....	155
*Bell ringer, the Bartow.....	132
*Bending tests of locomotive stay bolts, Cole's paper.....	100
*Block signal, the Payne.....	157
*Blocks, iron, Boston & Lockport Block Co.....	55
*Blocks, iron vs. wooden.....	55
*Boiler, A. T. & S. F. consolidated locomotive.....	23
*Boiler, Great Northern passenger locomotive.....	138
*Boiler, Great Northern heavy mastodon locomotive.....	9-10
*Boiler cleaner, the Hornish mechanical.....	169
*Boiler covering, Northern Pacific Ry.....	53
*Boiler covering tests, Norton's paper.....	112
*Boiler for consolidation locomotive, B. & M. R. R. in Nebraska.....	126
Boiler, what is the heating surface of, Baker's paper.....	112
Boilers, washing out locomotive.....	6
Book notes.....	55-69-158
Boxes, hot, treatment of.....	172, 173
Brake hose, second hand, on foreign cars.....	161
*Brake hose, specifications for, M. C. B. report.....	97
*Brake instruction car, N. Y. N. H. & H. R. R.....	105
*Brake lever arrangement, passenger, Great Northern Ry.....	4
Brake litigation.....	173
Brake practice, Kidder's paper.....	159
Brake records.....	40
Brake shoe tests, committee report on.....	91
*Brake shoe, Composite Brake Shoe Co.....	53
*Brake shoe, the Allen-Morrison, for steam roads.....	111
*Brake shoe, the Allen-Morrison.....	86
Brake shoes, worn out, carding for, car foremen's discussion.....	145
Brake shoes, worn out, in interchange.....	146-162
Brake shoes, worn out, in interchange.....	173
Brake shoes, worn out, responsibility for.....	146-162
Brake signals, M. C. B., action on.....	92
Brake tests, committee report on.....	91
Brakes in interchange, car foremen's discussion.....	145
Braking practice with double headers.....	54
Bronzes, analysis of.....	171
*Bumping post, the Haley.....	67
Business problems of the motive power department, Quayle's paper.....	37
Carbon in piston rods.....	84
Car construction, passenger, defects in.....	173
Car Foremen's Association of Chicago, the.....	107-123-144-159-172
Car Foremen's Association of Chicago, the by laws of.....	108
Car Foremen's Association of Chicago, the history of.....	107-160
Car Foremen's Association of Chicago, the work of.....	126
Car Foremen's Association of Chicago, the work of, Beecham's paper.....	109
Car framing, steel, M. C. B. report.....	97
Car inspector, the.....	146
Car inspection, joint.....	137
Car inspection, Waughop's paper.....	65
Car lighting on the Santa Fe.....	143
Car truck design, M. C. B. discussion.....	94
*Car wheel grinder, Springfield Mfg. Co.....	85
*Car, air brake instruction, N. Y. N. H. & H. R. R.....	105
Car, Baldwin motor, on the C. H. & D.....	51
*Car, buffet, Chicago Great Western Ry.....	128
*Car, mail, L. S. & M. S. Ry.....	47
*Car, 100,000-lbs. steel coal, Northern Pacific R. R.....	136
*Car, pile driver, L. S. & M. S. Ry.....	121-140
Cars, steel vs. wooden.....	39
*Clinker tongs, Williams'.....	155
*Compound locomotive engine, Vauclain, test at Purdue University.....	48
Conventions, the, exhibits at.....	101
Corrosion of iron and steel.....	164
*Coupler gage, Fildes'.....	92
Coupler inventions and patent points.....	83
Coupler, M. C. B., car foremen's discussion.....	123
Coupler, M. C. B., comment by A. M. Waitt and G. W. Cushing.....	62
Coupler, M. C. B. Is it a failure?.....	126

# RAILWAY MASTER MECHANIC.

<p>Coupler, M. C. B., Leeds' paper..... 127</p> <p>Coupler, M. C. B., the relative frequency of knuckle breakages ..... 153</p> <p>Couplers, M. C. B., the weights of..... 130</p> <p>*Couplers, substitute knuckle for..... 142</p> <p>Couplers broken, credit for..... 147</p> <p>*Crane, steam wrecking, Bucyrus, on the A., T. &amp; S. F. Ry..... 50</p> <p>Cranes, electric, at Crewe..... 6</p> <p>*Cylinder casting, Wisconsin Central lines..... 78</p> <p>*Cylinder fastenings, best form of, M. M. committee report, 115—Sague's report..... 128</p> <p>*Cylinders and valves of Great Northern mastodon 25</p> <p>*Cylinders, long stroke..... 19</p> <p>*Dome and fastenings, A., T. &amp; S. F. Ry..... 23</p> <p>*Drop doors for N. P. 100,000 lbs. steel car..... 166</p> <p>*Dust guard, the Harrison..... 130</p> <p>Efficiency of high steam pressure for locomotives, Master Mechanics' committee report..... 94-106</p> <p>Electric cranes at Crewe..... 6</p> <p>Electric distribution of shop power, Gibbs' paper.. 63</p> <p>Electricity in riveting..... 155</p> <p>Engine tests, standard..... 86</p> <p>Enginemmen, instructions to..... 48</p> <p>Exhibits at the conventions..... 101</p> <p>*Feed water heater—N. P. Ry..... 164</p> <p>Fire damage to wrecked cars..... 68</p> <p>*Fishplate punch, Hilles &amp; Jones'..... 27</p> <p>*Flue reducer, a pneumatic, Chicago Pneumatic Tool Co..... 114</p> <p>*Forging and heading machine, Acme Machinery Co..... 69</p> <p>*Forging locomotive rockers..... 111</p> <p>Forgings, steel ..... 67</p> <p>*Frame brace, A., T. &amp; S. F. Ry..... 23</p> <p>*Front end arrangement, A., T. &amp; S. F. Ry..... 23</p> <p>*Front end arrangement, Northern Pacific R. R. 110</p> <p>Fuel accounts ..... 40</p> <p>Fuel use on the Wabash..... 48</p> <p>*Gage, air, the semaphore..... 51</p> <p>*Gage, axle, Fildes'..... 142</p> <p>*Gage, coupler, Fildes'..... 92</p> <p>*Gage for worn couplers..... 165</p> <p>*Gage, the Crosby thermostatic..... 39</p> <p>Gages, locomotive steam..... 24</p> <p>Gates, end, missing..... 126-146</p> <p>German military railroading..... 122</p> <p>*Graphic methods as applied to railway records, Lyons' paper ..... 32</p> <p>*Grinder, chilled car wheel, Springfield Mfg. Co.. 85</p> <p>*Grinder, Universal Diamond Machine Co..... 173</p> <p>*Guide cup, the Hammett..... 12</p> <p>*Hammers, pneumatic, Ridgely &amp; Johnson Tool Co 62</p> <p>*Heading and forging machine, Acme Machinery Co..... 69</p> <p>*Heater, feed water—N. P. Ry..... 164</p> <p>Heating passenger ears, Garstang's paper..... 11</p> <p>Heating surface of a steam boiler, the, Baker's paper ..... 112</p> <p>*Hoist, pneumatic, Empire Engine &amp; Motor Co... 40</p> <p>*Hollow chisel ear mortising machine, J. A. Fay &amp; Co..... 113</p> <p>Hose, air brake, specifications for..... 65</p> <p>*Hose, nipple cap, The Peerless..... 11</p> <p>Hose, second hand, on foreign cars..... 161</p> <p>Injectors, locomotive, Bischoff's paper..... 20</p> <p>Inspection, car, Waughop's paper..... 65</p> <p>Inspection, joint car..... 137</p> <p>Inspector, car, the..... 146</p> <p>Inspection of railway supplies, Hodges' paper... 167</p> <p>Instructions to enginemmen..... 48</p> <p>Instructing trainmen in car construction and repairs ..... 75</p> <p>Interchange rules, car foremen's discussion... 124-141</p> <p>Interchange rules, the, M. C. B. action on..... 92</p> <p>Joint ear inspection ..... 137</p> <p>Joints, riveted, experiments on the frictional resistance of ..... 114</p> <p>*Journal box for 4 1/4 x 8 in. journals, M. C. B. report 99</p> <p>Journal boxes, care of, M. C. B. discussion on... 91</p> <p>*Knuckle, substitute, for M. C. B. couplers..... 142</p> <p>*Laboratories, testing, Galena Oil Co..... 78</p> <p>*Light, the Buckeye portable..... 86</p> <p>Lighting, car, electric ..... 173</p> <p>Lighting, car, on the Santa Fe..... 143</p> <p>*Locomotive, A, and its equivalent in raw material ..... 31</p> <p>*Locomotive, Brooks', for Korea..... 34</p> <p>*Locomotive, consolidation, B. &amp; M. R. R. R. in Nebraska ..... 127</p> <p>*Locomotive, consolidation, Chesapeake &amp; Ohio Ry 152</p> <p>*Locomotive construction, the advance in 10 years of ..... 145</p> <p>*Locomotive engine, Vaucrain compound, test at Purdue..... 48</p> <p>*Locomotive, first passenger built by C. &amp; N. W. Ry ..... 74</p> <p>*Locomotive, freight, Boston &amp; Maine Ry..... 52</p> <p>*Locomotive, heavy consolidation, Union Railway 150</p> <p>*Locomotive, heavy mastodon, Great Northern Railway ..... 8-25</p> <p>*Locomotive, mogul, Chicago Great Western Ry. 120</p> <p>*Locomotive, mogul freight, Grand Trunk Ry..... 61</p> <p>*Locomotive, Mogul, N. Y. C. &amp; H. R. Ry..... 168</p> <p>*Locomotives, passenger, retrospect and prospect.. 74</p>	<p>Locomotive, standard consolidation, A. T. &amp; S. F. Ry ..... 22</p> <p>*Locomotive, 10-wheel freight, St. J. &amp; G. I. Ry.. 156</p> <p>*Locomotive, 10-wheel passenger, Great Northern Ry ..... 138</p> <p>*Locomotive, 10-wheel passenger, Wisconsin Central Lines ..... 76</p> <p>*Lubricating device, the Tippet ..... 12</p> <p>*Lubricator and steam chest device, Michigan Lubricator Co ..... 54</p> <p>Lumber loading rules, M. C. B. action on ..... 92</p> <p>Man behind the gun, the ..... 146</p> <p>Manufacturers, National Association of ..... 26</p> <p>Master Blacksmiths' Association ..... 142</p> <p>Master Car and Locomotive Painters' Association. 114</p> <p>Master Car Builders' Association, committees for 1899 ..... 151</p> <p>Master Car Builders' Association, proceedings of Saratoga convention ..... 91</p> <p>Master Car Builders' Association, suggested topics for 1899 ..... 92</p> <p>Master Mechanics' Association, committees for 1898-99 ..... 120</p> <p>Master Mechanics' Association, proceedings of Saratoga convention ..... 93</p> <p>Master Mechanics' Association, suggested topics for 1899 ..... 94</p> <p>*Material, raw, in a locomotive ..... 31</p> <p>Mileage accounts ..... 40</p> <p>Military railroading in Germany..... 122</p> <p>*Mortising machine, ear, hollow chisel, J. A. Fay &amp; Co..... 113</p> <p>Motive power department, business problems of, Quayle's paper ..... 37</p> <p>Motor car, Baldwin, on the C. H. &amp; D. .... 51</p> <p>National Association of Manufacturers ..... 26</p> <p>*Nipple cap, hose, The Peerless..... 11</p> <p>Oil accounts ..... 40</p> <p>*Oil cups, the Hammett..... 12</p> <p>Oil in steam boilers ..... 52</p> <p>*Oil testing, laboratories, Galena Oil Co ..... 78</p> <p>*Oil testing machine, Galena Oil Works ..... 80</p> <p>Paint tests ..... 26-66</p> <p>*Passenger ear pedestal and journal box for 4 1/4 x 8-in. journal, M. C. B. report ..... 99</p> <p>*Passenger engines, retrospect and prospect. ... 74</p> <p>Patents, coupler ..... 83</p> <p>*Pedestal, passenger car, for 4 1/4 x 8-in. journal, M. C. B. report ..... 99</p> <p>Pedestals and boxes, passenger car, M. C. B. action on ..... 92</p> <p>*Pile driver car, L. S. &amp; M. S. Ry. .... 121-140</p> <p>Piping of ingots ..... 61</p> <p>Piston rods, carbon in ..... 84</p> <p>*Piston valve, Wisconsin Central Lines ..... 78</p> <p>*Piston valves ..... 19</p> <p>*Plow, ballast, Northern Pacific R. R..... 155</p> <p>*Pneumatic hoist, Empire Engine &amp; Motor Co... 40</p> <p>*Pneumatic hoist for loading wheels, C. &amp; N-W. Ry. .... 143</p> <p>Power, shop, electric distribution of, Gibbs' paper 63</p> <p>President's addresses at Saratoga..... 92</p> <p>Private car lines, relation of to railroads, Shower's paper ..... 108</p> <p>*Protection of steam heated surfaces, Norton's paper ..... 112</p> <p>*Punch, fishplate, Hilles &amp; Jones'..... 27</p> <p>*Punching and shearing machine, Williams', White &amp; Co..... 53</p> <p>Purchase and inspection of railway supplies, Hodges' paper ..... 167</p> <p>*Q &amp; C exhibit at the Omaha world's fair..... 131</p> <p>Railway statistics ..... 132</p> <p>*Railway train, the first..... 158</p> <p>*Records, graphic, Lyons' paper..... 32</p> <p>Resistance, air, to the motion of trains, Goss' paper ..... 87-110</p> <p>Riveted joints, experiments on the frictional resistance of ..... 114</p> <p>Riveting by electricity..... 155</p> <p>*Rockers, locomotive, the forging of..... 111</p> <p>*Rod cup, the Hammett..... 12</p> <p>*Rotation, high speed, McElroy's paper..... 5</p> <p>Rules for employees, impracticable..... 83</p> <p>*Rust from salt water drippings, M. C. B. report.. 96</p> <p>Salt water drippings, M. C. B. action on..... 91</p> <p>*Salt water drippings, rust from, M. C. B. report.. 96</p> <p>*Sand drier, Parkhurst &amp; Wilkinson Co..... 85</p> <p>*Sash rack, L. S. &amp; M. S. Ry..... 85</p> <p>Section 20, Rule 3..... 146-162</p> <p>Semi-steel ..... 60</p> <p>Shearing and Punching of Metals..... 174</p> <p>*Shearing and punching machine, Williams, White &amp; Co..... 53</p> <p>*Shops, Concord, Boston &amp; Maine Ry..... 32</p> <p>*Shops, Lima, C. H. &amp; D. Ry..... 154</p> <p>*Side bearing, frictionless, as affecting wheel wear 41</p> <p>*Signal, the Payne train order and block..... 157</p> <p>*Signal, train order, the De Wallace..... 141</p> <p>Sinclair, Robert ..... 165</p> <p>*Spark arrester, Northern Pacific R. R..... 60-110</p> <p>*Specifications for air brake hose, M. C. B. report. 97</p> <p>Specifications for air brake hose..... 65</p> <p>*Spring arrangement, Wisconsin Central Lines... 76</p> <p>*Springs for freight car trucks, M. C. B. report... 95</p>	<p>Standards, M. C. B., committee report on..... 91</p> <p>Standards, M. C. B., revision of..... 40</p> <p>Statistics, American railway..... 132</p> <p>*Stay bolts, bending tests of, Cgle's paper..... 100</p> <p>*Staybolts, radial and sling, C. &amp; O. Ry..... 169</p> <p>Stays, fire box, strength of..... 171</p> <p>Steam gages, locomotive..... 24</p> <p>Steam pressure, high, for locomotives, Master Mechanics' eommittee report ..... 94-106</p> <p>Steel ear framing, M. C. B. report..... 97</p> <p>Steel forgings ..... 67</p> <p>Steel vs. wooden cars..... 39</p> <p>Supplies, purchase and inspection of, Hodges' paper ..... 167</p> <p>Supply trade notes..... 13-28-41-56-70-88-101-116-133-147-162-175</p> <p>*Testing laboratories, Galena Oil Co..... 78</p> <p>*Testing locomotive materials, Midland Ry..... 170</p> <p>*Testing machine, oil, Galena Oil works..... 80</p> <p>*Testing machine, Whitworth hydraulic..... 170</p> <p>Testing materials, the association for..... 113-142</p> <p>Tests, axle, New York Car Wheel Works..... 28</p> <p>Tests, car wheel, New York Car Wheel Works.... 27</p> <p>Tests, engine, standard..... 86</p> <p>Tests, paint..... 26-66</p> <p>*Tie extractor and replacer, Smith Mfg. Co..... 174</p> <p>*Tongs, elinker, Williams'..... 155</p> <p>*Train, the first railway ..... 158</p> <p>*Train order and block signal, the Payne..... 157</p> <p>*Train order signal, the De Wallace ..... 141</p> <p>Trainmen, Is it desirable to instruct them in the details of car construction and repairs ..... 75</p> <p>Trains parting, M. C. B. discussion..... 91</p> <p>*Trains parting ..... 65</p> <p>Traveling Engineers' Association..... 144</p> <p>Triple valves in interehange, car foremen's discussion ..... 145</p> <p>Triple valve tests, committee report on ..... 91</p> <p>Truck design, M. C. B. discussion ..... 94</p> <p>*Truck, for Northern Pacific 100,000 lbs. steel coal car. .... 137</p> <p>*Turbines, steam ..... 6</p> <p>*Valve, air, for pneumatic track sanding, the Curtis ..... 158</p> <p>*Valves, piston ..... 19</p> <p>*Valve, piston, Davis' ..... 19</p> <p>*Valve, piston, Warner's ..... 20</p> <p>*Valve seats, false..... 166</p> <p>*Valve stem motion, Northern Pacific Ry ..... 51</p> <p>*Valves and cylinders of Great Northern mastodon ..... 25</p> <p>*Vestibule, home made, Great Northern Ry..... 4</p> <p>*Viscosimeters, Galena Oil Works ..... 84</p> <p>Washing out locomotive boilers ..... 6</p> <p>Waste accounts ..... 40</p> <p>Water, analysis of, for scale forming ingredients... 150</p> <p>*Water purifier, the Hornish..... 169</p> <p>*Wheel loading by air, C. &amp; N. W. Ry..... 143</p> <p>Wheel tests, New York Car Wheel Works ..... 27</p> <p>Wheel treads, hollow..... 126</p> <p>*Wheel wear, frictionless side bearings as affecting ..... 41</p> <p>Wheels comby from sliding ..... 126</p> <p>Worn out parts ..... 127</p> <p>Wrecked ears, fire damage to ..... 68</p>
---	--	--

## COMMUNICATIONS.

<p>Brake hose tests, <i>Master Mechanic</i> ..... 104</p> <p>Braking trains in Mountain Service, <i>Master Mechanic</i> ..... 73</p> <p>Braking trains partially equipped with air, <i>C. L. Nicholls</i> ..... 7</p> <p>Car builder, master, the title of <i>Car Builder</i>..... 24</p> <p>Clerks, chief and the conventions, <i>John H. Good-year</i> ..... 68</p> <p>Coupler, M. C. B., <i>Geo. W. Cushing</i>..... 62</p> <p>Coupler, M. C. B., <i>E. W. Grieres</i>..... 73</p> <p>Coupler, M. C. B., <i>P. Leeds</i>..... 153</p> <p>Coupler, M. C. B., <i>A. M. Waitt</i>..... 62</p> <p>Cylinder coverings, <i>Geo. B. Snow</i>..... 36</p> <p>Cylinders, long stroke, <i>Observer</i>..... 24</p> <p>Deterioration of steam Dry Pipes, <i>W. de Sanno</i>.. 105</p> <p>Dry pipes, deterioration of, <i>W. de Sanno</i>..... 105</p> <p>Fads—Some Suggestions About, <i>Wm. F. Monaghan</i>. 7</p> <p>*Front end arrangement, Bell, on G. N. Ry., <i>Geo. W. Cushing</i> ..... 37</p> <p>Gauges, locomotive steam, <i>Theo. H. Curtis</i> ..... 46</p> <p>*Gauges, locomotive steam, <i>Wm. F. Monaghan</i>... 35-68</p> <p>Gauges, steam, effects of heat on, <i>Ashton Valve Co</i>. 36</p> <p>Handling Trains partially equipped with air, <i>C. L. Nicholls</i> ..... 7</p> <p>Hose tests, <i>Master Mechanic</i> ..... 104</p> <p>Long stroke cylinders, <i>Observer</i> ..... 24</p> <p>Oiling cars, cost of, <i>Car Builder</i> ..... 37</p> <p>Patents—"Useless," <i>Paul Sjnnestradt</i>..... 8</p> <p>Prices, M. C. B., changing, <i>H. M. Perry</i>..... 73</p> <p>"Rough Usage" in the handling of cars, <i>H. M. Perry</i>..... 24</p> <p>*Spark arrester, Bell, on G. N. Ry, <i>Geo. W. Cushing</i>. 37</p> <p>Steam Gauges, effect of heat on, <i>Ashton Valve Co</i>. 36</p> <p>Steam Gauges, locomotive, <i>Theo. H. Curtis</i>..... 46</p> <p>*Steam Gauges, locomotive, <i>Wm. F. Monaghan</i>.. 35-68</p> <p>Steam jacketing locomotive cylinders, <i>Geo. B. Snow</i>. 36</p> <p>*Temperature and strength of materials, <i>Wm. F. Monaghan</i>..... 35</p>
---

# RAILWAY MASTER MECHANIC.

## NOTES OF THE MONTH.

Accidents, railway	155
Acetylene as an illuminant	17
Autononin as a wood preservative	46
B. & O. car equipment	31-140
Baltimore & Ohio, the, entrance to New York	17
Bearing metals	3
Car building, technical education in	44
Car designing	44
Car lighting	18
Cars, steel, big order for	30
Central Railway Club smoker	15
Chinese trade	32
Chronograph, a delicate	60
Classification of cars	105
Cleaning rusted iron	60
Clinker pullers, responsibilities of	73
Coal plant, B. & O. Ry	18
Coaling stations, power-operated	45
Corean railway order	45

Electric power transmission	45-59
Employes, railway, compensation of	155
Employes, railway, defenced	46
Employes relief and savings fund, P. R. R.	45
Gas, natural	59
Grab irons	18
Graphite as a cylinder lubricant	59
Gun shop of the Niles Tool Works	59
*Hospital, Chesapeake & Ohio Ry	17
Instructions to employes	110
Journal hearing metals	3
Labor and machinery	45-72
Labor troubles, ancient	121
Locomotive, B. & O. No. 99	169
Lubrication of gas engine cylinders	59
Machinery, the moral uses of	3
Machinery and labor	45-72
Marking light weights on cars	104
Men and machinery	72
Moral uses of machinery	3
Motor cars on the C. H. & D.	111
Paints, preservative, tests of	18

Patents, validity of	17
Personal injury cases	17
Pneumatic power transmission	59
Power transmission	59
Premiums for engine men	18
Purdue engineering laboratory	59
Purdue university work	45-59-152
Railway Y. M. C. A. work	45
Rust preventer, German	45
Relief and savings fund, P. R. R.	45
Rubber in South America	169
Rusted iron, cleaning	60
Scholarships, Master Mechanics'	58
Sleeping car equipment	151
Stay bolts, center drawn	17
Steel cars	30
Strike, the English	45
Tools, location of in cars	18
Welsbach light mantle	45
Wood preservation	46
*Woods, mechanical tests of	3
Y. M. C. A. work	45

## PERSONAL.

Adams, Chas. B.	70	Croxon, F. T.	55	Hargreaves, Geo.	56	McClellan, B. S.	159	Pickey, John	56	Stranahan, John	174
Agnew, A. F.	147-159	Curley, M. S.	116	Harkom, J. W.	69	McClelland, Jos. A.	132	Platten, J. W.	159	Studen, O. L.	32
Allibone, A. D.	41	Dallas, A.	100	Harrison, R. H.	175	McCammon, W. I.	41	Prescott, Geo. H.	70	Sumner, A. W.	41
Anderson, E. E.	147	Davis, T. A.	55	Harris, W. H.	175	McCullom, A. D.	28	Prescott, Geo. W.	56	Sutherland, C. H.	174
Appleyard, W. P.	116	Dawson, Walter	70	Hart, A. D.	159	McCullough, J. C.	87	Price, W. H. H.	159	Symington, Thos. H.	116
Baldwin, Wm. B.	175	Dedman, E. J.	175	Hart, S. K.	159	McDill, Geo. B.	41	Raike, F. M.	28	Symonds, Samuel	100
Barnard, H. C.	70	DeHaven, C. A.	174	Harter, C. C.	88	McGill, J. H.	69	Record, John W.	88	Symons, W. E.	116
Barnes, F. P.	116	Delaney, C. A.	159	Hawthorne, John	116	McGill, J. H.	69	Reed, O. J.	55	Tandy H.	116
Baulch, J. J.	70	Delaney, Harry	100	Hemphill, W. J.	88	McGrath, J.	71	Rees, John T.	159	Taylor, Edmund	41
Beardsley, W. F.	69	Demorest, Thos. W.	56-132	Henney, John	116	McHattie, Thos.	70	Rees, Wm.	132	Thomas, J. G.	70
Beggs, C.	69	Dewey, H. A.	147	Henrietta, J. B.	41	McKeen, Jr., W. R.	55	Richards, Geo. F.	116	Thompson, A. L.	132
Bentley, H. T.	159	Dickson, Geo.	28	Herman, C. G.	55-132	McLaren, John G.	147	Richards, Jackson	147	Thow, Wm.	147
Bishop, H. A.	116	Downing, T. M.	13-147-175	Herr, E. M.	132	McMains, Robt.	55	Rittenhouse, E. E.	28	Tollerton, W. J.	56
Blackburn, Joe	116	Duesberry, R. H.	116	Hess, Geo. F.	159	McNaughton, Jas.	100	Roberts, H.	100	Tozzler, George	69
Boatman, F. P.	13	Dunlop, Chas. M.	69	Hewitt, Frank C.	56	McWilliams, R. E.	132	Roberts, H. H.	70	Traver, Jas. J.	87
Boutelle, S. C.	132	Dzushi, T. Y.	147	Hickey, James	41	Machesney, A. G.	132	Roberts, J. W.	69	Trowhridge, E. P.	116
Borgert, Otto	159	Eddy, Wilson	147	Hildreth, F. F.	69	*Maillefert, Gustave	J	Roberts, S. M.	55	Tubby, W. G.	28
Bowen, H. A.	116-132	Edwards, J. A.	41	Hill, John, Sr.	147	J	13	Roser, C. H.	159	Turner, J. S.	159-175
Boyer, J. B.	159	Ellersbe, E. H.	147	Hohart, Horace R.	147	Malone, D. J.	56-57	Robb, Wm.	174	Turnbull, W.	70
Brandow, B. R.	55	Emerson, F. O.	132	Hoffecker, W. L.	132	Marsh, Henry, Jr.	132	Rossiter, Boaz	147	Viennot, Thos. B.	88
Briscoe, Benj.	88	English, Richard.	55	Hoffecker, W. L.	70	Marden, J. W.	88	Royal, Chas. B.	70	Underwood, T. F.	88
Brown, Angus	116	Ennis, W. C.	175	Hoffman, John	174	Martin, Jesse C.	159	Russell, W. H.	159	Van Dell, J.	70
Brown, Frank	147	Evans, Geo. F.	159	Horiye, T. S.	147	Martin, J. C.	175	Russell, W. H.	175	Vaughan, H. H.	41-175
Brown, F. R. F.	56-147	Felske, Chas. H.	159	Houghton, Chas.	55	Massey, A. P.	100	St. Clair, W. P.	88	Viennot, Jules	150
Brown, Martin	174	Fernow, B. E.	116	Husted, R. W.	116	Mavern, A. A.	70	Sandt, Eugene I.	100	Vought, Harry D.	28
Bnshey, T. A.	28	Fitzgerald, J. M.	69	Hnston, P. P.	116	Maxwell, A. H.	13	Sarsent, Frank P.	132	Walker, H. E.	41
Busser, S. E.	159	Forbes, S. F.	28	Hyden, P. L.	41	Medway, J.	88-175	Scarritt, J. G.	70	Wallace, John F.	28
Butter, Charles	132-159	Ford, W. C.	13	Jackson, L. A.	159	Meehan, Jas.	147	Sedgwick, E. B.	41	Warner, E. D.	28
Bywater, Geo. G.	87	Forsyth, William	132	Jameson, E. D.	159	Miller, E. A.	28	Seidel, G. W.	56	Weaver, J. N.	132
Cain, Frank	132	Foster, John Jr.	174	Jennison, N. E.	38	Miller, Frank	175	Seitz, Edward D.	116	Wehh, Perry	88
Canfield, L. T.	70	Fouik, John	174	Johann, F. A.	70	Mings, A. H.	69	Shannon, John W.	147	Wentz, Jr., W. W.	116
Carey, Jas. T.	88	Fouik, John.	147	Johns, Henry W.	41	Moler, A. L.	116	Sharp, W. E.	147	Westinghouse, Geo.	70
Carleton, E. T.	56	Fraser, George	69	Johnson, Frank	116	Montgomery, H. S.	69	Shaughnessey, John F.	88	Whaling, John A.	41
Carmichael, Jas	159	Fraser, Thomas A.	159	Joughins, G. R.	70	Mooney, E. P.	56	Shellhorn, T. J.	174	White, H. J.	175
Carter, John	41-55	Frost, Harry W	13	Justice, J. G.	55-56	Moser, Edw. L.	41	Sherman, L. H.	100	Whitmer, J. W.	147
Cassie, Geo. R.	175	Fullerton, D. K.	175	Kellogg, D. P.	174	Mott, D. G.	28	Shields, Alex.	13-100	Whittaker, W. H.	100
Chambers, J. S.	159	Gable, Peter	159	Kells, Willard	116	Mudd, H. K.	159	Slater, Frank	55	Widgeon, W. E.	70
Chapman, J. C.	174	Gallagher, G. A.	147-159	Killen, W. E.	147	Mulligan, John.	41	Slayton, C. E.	174	Wild, Frederick	100
Chater, John A.	13	Gardner, F.	174	Kircher, T. A.	69	Nason, C. S.	41	Sloan, Theo. W.	147	Wilson, W. L.	159
Clacas, H. E.	175	Gorlick, W. H.	147-159	Kirk, Jas. M.	41	Nicholson, G. B.	116	Smith, A. C.	56	Wing, Fred	69
Clarkson, W. S.	116	Garrison, P. E.	28	Knapp, E. W.	132	Nicholas, I. O.	132	Smith, F. B.	41-69-116	Winslow, J. M.	69
Coffman, B. N.	70	Gee, John A.	132	Laing, O. M.	147	Ogilvie, J.	69	Smith, Geo. W.	56	Wirt, G.	132
Coffee, C. A.	174	Gesner, B. C.	174	Lamb, C. E.	116	O'Hearne, Jas	132	Smith, R. E.	116	Wohrle, Edward J.	69
Coleman, C. P.	69	Gill, John T.	116	Lawes, T. A.	13	Overton, D. B.	56	Snow, W. B.	159	Worhle, John	147
Coleman, Chas.	70	Godfrey, W. T.	41	Lawrence, John	159	Pace, R. T.	132	Snyder, B. F.	159	Work, A. S.	28-159
Conrad, C. H.	28	Gould, J. S.	132	Leighton, Geo. B.	70	Palmer, E. C.	159	Spain, W. J.	174	Worman, E. T.	174
Conrod, Harry	28	Greening, H. B.	28	Lentz, Jno. S.	28	Parent, A. M.	100	Sprowl, Norman	175	Worman, Wm. S.	41
Corey, Jas. A.	28	Greer, Geo	28	Lindsey, Alex.	69	Passmore, H. E.	159	Stark, C. S.	88	Wormbledorf, H. C.	147
Cormack, Wm.	174	Grieves, E. W.	13	Longstreth, Jos.	69	Peach, John T.	116	Stevens, Geo. W.	116	Wright, William	132
Cooke, W. I.	147	Groves, J. R.	70	Lovell, Alfred	147	Peddle, W. H.	13	Stimson, Albert M.	56	Wyler, Paul J.	159
Coster, Edward L.	100	Halfman, W. C.	69	Lowell, W. W.	116	Percy, Jas. M.	41	Stokes, J. W.	88	Yeomans, Geo. G.	56
Cramer, C. B.	174	Hanson, B. R.	13	Lundie, John	159	Percy, Wm.	175	Stokes, J. W.	174	Young, J. W.	159
Creamer, W. G.	70	Harding, E. H.	69	Lyddou, Harry	116	Peterson, W. C.	69	Stone, W. A.	55-147		

# RAILWAY MASTER MECHANIC

WALTER D. CROSMAN, Editor.  
EDWIN N. LEWIS, Manager.

PUBLISHED MONTHLY BY

THE RAILWAY LIST COMPANY

Devoted to the interests of railway motive power, car equipment, shops, machinery and supplies. Communications on any topics suitable to these columns are solicited.

Subscription price, \$1.00 a year, to foreign countries \$1.50 free of postage. Advertising rates given on application to the office, by mail or in person. Address

THE RAILWAY LIST COMPANY,  
The Rookery, Chicago, Ill.

The Official Railway List is published by this company.

VOL. XXI. | CHICAGO, JANUARY, 1898 No. 1.

The *Official Railway List*, which has been placed annually on the desk of every railway officer in the country for sixteen years, is henceforth to be published every month, beginning with January. The *Monthly List* is like the annual in appearance except that it has paper covers and is, practically, a monthly magazine filled with the information which has made the annual edition indispensable in most railway offices. An editorial and "personal news" department adds to its interest and usefulness, and is a new feature in such publications.

A NUMBER of years ago the technical universities took up the idea of arranging vacation excursions for their students, in order that all the students who wished to do so might visit the more prominent and interesting manufacturing establishments. Such an excursion would frequently extend through a period of ten days or two weeks, and such manufacturing establishments would be visited as could be reached easily in a night's trip between cities. Excursion rates were obtained, and whether a student was interested in mechanical or other engineering pursuits, he was frequently urged to accompany one of these excursions. The idea was, primarily, to give those pursuing engineering studies the advantage of an insight into the methods of manufacturing used by various firms, and an understanding of the nature of the product of each. The manufacturers were quite willing to allow such visits, and frequently took much inconvenience upon themselves in receiving the students and in explaining the methods pursued in the factory. The idea of the manufacturer was that these students would, in the course of years, become engineers, and would, perhaps, be placed in positions where a knowledge of the product of his factory might result in much profit to the manufacturer, and the engineer as well. In so far as the manufacturer was concerned, this was beginning with the prospective engineers and waiting, perhaps a number of years, for the expected returns. The idea has now been developed to such a point that manufacturers are receiving, not only the prospective engineers, but are soliciting visits from the more experienced engineers, and it is in order now for large establishments to provide excursions to their works or induce various engineering societies to visit their works and learn as much as possible about their product.

THOSE railroads which have been developed into large systems by absorbing various smaller roads have had the misfortune to inherit locomotives, cars and other equipment of greatly varying designs. Perhaps any one design so inherited would prove satisfactory if used by itself, but combining the several ones it is very expensive to carry repair parts and new pieces sufficient to keep the various designs in running order. It devolves upon the mechanical and other departments to strike a happy medium between the various designs and to develop one which will work out satisfactorily, and will cause the least disturbance to the new system, and will reduce

to the minimum the stock to be kept on hand. In accomplishing this some patterns of one road will be abandoned and those of another substituted in one case, and, in another, perhaps the order will be reversed. To accomplish the desired results, with most systems, the standardizing of parts will be placed in the hands of an individual and worked out by him as he may decide best. This will be accomplished most readily if all concerned are posted thoroughly on the line of work to be pursued. And while master mechanics or other officers, who are inherited with the smaller roads, may, from appearance, seem to lack confidence in the scheme which changes too much their former methods, it will generally be found that the seeming indifference is due to lack of information of the course being pursued. The superintendent of motive power, or the superintendent of the car department, may work out most elaborate schemes for standardizing and reducing the number of parts and the method of doing work, but if such schemes are not spread to the master mechanics and foremen they might better not be devised. Generally, it will be found that sufficient consideration is not given to the spreading of information by the higher officers, and too frequently the schemes thus worked up in the drawing room or in the general offices fail because interest is lost in the matter before it is spread to those who will naturally be charged with seeing that the propositions are effectively carried out.

THE Association of Superintendents of Bridges and Buildings is finding a considerable amount of work to do that relates to matters of special interest to mechanical officials. At its recent Denver meeting it covered in most admirable shape such topics as methods of heating buildings, roofing materials for buildings, and overhead bridge warnings. The association has already issued its program for the convention which will be held next October at Richmond, Va., and of its eleven stated topics for committees we note five that are of direct interest to the master mechanic. These topics are "Best Floors for Shops and Round-houses", "Roundhouse Smoke Jacks and Ventilation", "Prevention of Fire in Railroad Buildings", "Turntable Construction", and "Storage of Fuel, Oil and other Station Supplies at Way Stations." It will be seen that the bridge and buildings superintendents have taken up some matters which the master mechanics might have been thoroughly glad to have conclusively covered in associational work themselves long ago. Now they must await suggestions from another department on these really important points, and it is to be assumed that the Association of Railway Superintendents of Bridges and Buildings will, despite its cumbersome title, give its customary well prepared, concise conclusions through its committees. After all is said, it is well that it should be so. There has been in the past entirely too much isolation of departments in railway service. Each worked for itself and expected the devil to take the hindmost. But of late there is a warmer feeling, which is permitting, and even welcoming, incursions from one department to the other, the object being always understood to be to secure the best results for the common cause. It has not been, we regret to say, a permeation of the milk of human kindness which has caused this change to more fraternal work; it was born from business conditions and has come about in a business way. We are glad to see that this borrowing and lending of ideas among the departments in daily work is finding its reflex in the work of the associations. In this connection we may state that the railway clubs have from time to time endeavored to broaden their field of work—to take up topics not distinctively mechanical for consideration—and we understand that the Western club, particularly, will make special effort during the balance of the current season to handle topics that are not strictly mechanical.

ON SEVERAL occasions the question has come to us as to the effect of air admitted above the fire bed in a locomotive fire box. It is an old problem, but practice seems to have demonstrated certain facts pretty con-

clusively. The effect of the cold air which is drawn in the locomotive fire door when full open is to lower the temperature of the gases and to reduce the evaporation. This effect is mitigated to some extent by the brick arch, which not only assists in mixing the hot gases with the air, but keeps them hot, so they are properly burned before reaching the tubes. This is one of the incidental benefits of the brick arch, and it is surely a valuable one in protecting the tubes from the chilling effect of the intruding current of cold air. A device which is quite generally used in England to produce a somewhat similar effect as that described for the brick arch is the deflector plate, or hood, which is hung inside and above the fire door, and which drives the cold air down into the fire and mixes it with the hot gas before it reaches the tubes. Where neither the brick arch nor the deflector plate are used, and the cold air is drawn directly to the tubes, its effect is bad, not only on the fire, but on the tubes, often causing them to leak. While it is a favorite theory with many that a large volume of air above the fire is necessary for complete combustion, no one will claim that it should be introduced through so large an opening as the fire door. Many locomotives have holes in the stay bolts above the fire, for the purpose of supplying air for burning the gases; but, while they have been in use for many years, it is doubtful whether they are always necessary, as it is generally considered that, with a light fire, sufficient air is drawn through the grates for this purpose. We are assured that it is a fact also that as good, or better, evaporation is obtained without them, although, as is well known, there are those who will contend to the contrary view. For the reasons already given, it appears unquestionable that the size of the fire door should be limited to that necessary for getting the coal into the fire box by the ordinary method of shoveling. If the steam requirements of the locomotive were more regular it might be possible to use some form of automatic stoker without any fire door, thus doing away with the constant door opening, with its attendant evils. Automatic stokers are now generally used in the best stationary boiler practice, and one of the chief good features of these stokers is the fact that they dispense with the frequent opening of the fire doors. It is possible that on runs where the steam requirements are quite regular, an automatic stoker might be used to advantage on a locomotive, and we believe that the experiment is worth trying.

There has been some discussion as to whether electricity, compressed air, or a liquid under high pressure is most convenient at railroad or other shops. Representatives of each kind of equipment will argue strongly that their special line will prove to be the power best adapted to all classes of work. They recognize full well that they overstep a point but they do not acknowledge it to others. The form of motor best adapted for a shop, and in this case we refer particularly to railroad shops, depends upon the work to be done; there is a place for electric power, for hydraulic power, and for pneumatic power.

There are many light tools which can be operated best by compressed air, and there are other tools for which electricity furnishes the best motive power, and there are still others in which hydraulic power, provided by a hydraulic pump or a hand pump, is best adapted.

The hand pumps, or presses, are best adapted for use in locations which are widely separated and when the number of times the power may be necessary in one place will not warrant the expense of conducting a continuous power to these points. In other words, it is frequently cheaper to develop power by hand work than to transform it at another point and conduct it to a point where it is to be used. As an example of what we refer to, we may mention the crank pin press. The pressure necessary to press crank pins into position may be quite high, but it can generally be developed better by a hand press than by other means.

There are other places where the hand press or jacks can be used to a greater advantage and many

such places will be readily called to mind by a man familiar with locomotive or car repair work.

One must be courageous indeed to say that electricity is the cheapest form of power for every operation in new or in repair shops or that air motors will prove to be the cheapest power, or that hydraulic power can be replaced in every instance with motors or other forms. There is a field for each and it is difficult to determine the location of the dividing lines between each or, in some instances, to make a selection of the most economical motor. The man who is manufacturing electric motors will make a strong effort to appropriate some of the territory which naturally belongs to him who is manufacturing air motors or hydraulic machinery, and the man who is manufacturing air motors will likewise try to get a slice of the territory which can be best operated by hydraulic machinery or electric motors, and the same is true of the man handling hydraulic machinery.

This condition of affairs is natural and it devolves upon the man who is buying machinery to pay particular attention to the merits of each kind of motor and where his requirements are near the line separating the machinery of one class from that of another he must be the more careful in his selections.

#### HANDLING TRAINS PARTIALLY EQUIPPED WITH AIR.

In another column of this issue we print in full a communication from Mr. Nichols in reply to our criticism of a former paper of his upon the handling of freight trains partially equipped with air.

In the communication referred to Mr. Nichols certainly shows that he has given the questions involved a most exhaustive examination and study, and it goes without saying, that the results obtained through such conscientious efforts as he has made, and is making, are worthy of serious consideration. We are still inclined to the opinion, however, that the rule advocated by Mr. Nichols is not the correct one. We have already called attention to the fact that it is diametrically opposed to the recommendations adopted by the Air Brake Men's Association, and it is certainly to be presumed that this body of men, most of whom for years have made a special study of the points involved in this controversy, and nearly all of whom have had personal experience in the handling of trains upon the road, must have had good reasons for adopting the recommendations contained in the paper presented by Mr. Hutchins at the Columbus meeting.

It seems to us that the difficulty attending the use of hand brakes upon the rear ends of long trains partially equipped with air, rather than upon the forward cars not so equipped, arises from the fact that the air brake cars ahead must be occasionally set and released by the engineer in making station or water tank stops, and where the slack is being held out upon the rear end of the train, proper freedom of control over the air brake cars by the engineer is seriously interfered with, and each application and release of the air brakes causes violent surging in the train. If, on the other hand, in the beginning of an application a few hand brakes are set on the cars immediately in the rear of the air brake cars, the slack upon the rear end is caused to run in, and the train, or at least the main portion of it, is "bunched," and kept in such condition until the completion of the stop. This certainly is easier upon the draw bars and upon the lading than a succession of bunching and stretching operations.

At first glance the statistics or tables given by Mr. Nichols appear to show striking results, very favorable to his contention, but upon a closer examination of the same we find that they do not really contain any exact figures as to the condition of affairs prevailing prior to the adoption of the rule which Mr. Nichols advocates. The bad results shown during the first two months that the rule was put into operation, would appear, in the absence of other data, to be rather against the rule than in favor of it, and the fact that a marked, we may say a very marked, improvement is shown in the results recorded during the corresponding months of the succeeding year, may very probably be mainly due simply to the fact

that the men had by that time become much more familiar with the peculiar method of handling trains required by the rule, and had become more skillful in avoiding the more violent shocks which had been produced when the rule was first put into operation. We are inclined to the belief that if just the same degree of care and attention had been enjoined upon the men in the observance of a rule similar to that recommended by the Air Brake Men's Association, and if they had been systematically instructed as to how to follow such rule, better results could have been recorded than those given, for it must be conceded that the great improvement disclosed by the tables evidences great care and persistence, not only on the part of the train men and engineers, but also on the part of those in authority over them.

Criticising our last month's editorial, Mr. Nichols says, "How much more violently would the slack run in if there were no brakes set on the rear end." We contend that with proper handling of the train on the part of the engineer, and, if it be necessary, the application of one or more of the hand brakes immediately back of the air brake cars, there would be less shock upon the rear end than almost inevitably results when the rear hand brakes are used, for the stretching of the train by the latter interferes seriously with the proper "bunching," which is a necessary preliminary to all scientific air brake stops.

As to breaking in two on descending grades, it is difficult to see why the use of hand brakes upon the rear end (rather than upon the forward portion of the non-air-brake cars, the latter method, be it remembered, keeping the back end of the train "bunched"), should be the more effective method of preventing separated portions from again colliding.

We are utterly at a loss to understand any reason why a recommendation should be made, that where "the train consisted of thirty cars, all told, twenty-nine air brakes, a sufficient number of air brake cars, beginning at the rear," should be cut out to permit the movement of the train to be controlled by hand.

As to the example cited, where a long train going up grade at a speed of ten miles an hour was suddenly stopped by the bursting of a hose, and damage resulted from the violence of the application, and as to the point made in this connection about the speed being only about ten miles an hour, it is to be remarked that we understand it to be a fact recognized by most air brake men, that emergency applications at slow speeds are generally much more violent and destructive in their results than emergency applications made at high rates of speed. Thus, if, when a train is just crawling along at a speed, say from three to five miles an hour, an emergency application of the brakes be made, the shock upon the rear end will be extremely violent, while if a train be running sixty miles an hour, more or less, emergency applications can be made with comparative impunity without causing serious damage. The reason for this appears to lie in the fact that at high rates of speed the brake shoes are considerably slower in reaching their maximum frictional effect upon the the peripheries of the wheels.

#### THE GREAT STRIKE IN ENGLAND.

The present "engineers" strike in Great Britain involves more valuable interests and important principles than any strike of past years. The striking workmen are those whom in this country are called "machinists" and the number of them is said to be not less than 50,000 skilled workmen. At its beginning the strike was entered upon to enforce a demand for an eight hour day, made by the labor union. The movement was met by a general lockout on the part of the employers who determined to settle a question of more importance to them than an eight hour labor day, viz; the right to control their own shops. It appears that the British manufacturer has not been able to profit by the use of improved machine tools to anything like the extent that the German, French and American manufacturers have profited. The powerful labor union to which their employes belong has compelled them to forego the principal advantages of such tools. They were

forced to employ skilled workmen to operate machines which were designed to be run by unskilled and cheap men or boys, and were forbidden to put more than one machine in charge of one workman. While in other countries one man operated two or more similar machines. For many years British manufacturers were able to compete successfully with those of other nations in the markets of the world in spite of these hindrances to the most economical production: but for the last ten years the competition of other countries has been steadily increasing until, to-day, they see themselves in serious danger of losing that supremacy in the manufacturing world which they have held for so long and which has given England so much of its enormous wealth. Belgium has been sending structural steel into England for several years: the English markets are flooded with articles made in Germany, and American machine tools and many other machine shop products are being sent to English colonies and even into England itself.

Confronted with such conditions and threatened with such dangers it is not strange that the British manufacturer refuses to consent to an eight hour day in place of one of ten hours nor that he insists that he shall be allowed to decrease the cost of his product by taking all the advantage possible of improved machinery in lessening his pay roll and increasing his output. It is a fight for his life that he is waging.

It is a costly battle to both parties. All over England shops are closed, contracts unfulfilled, orders cannot be taken, customers are lost and the great currents of trade are beginning to flow in other channels. The labor union which is making the fight is said to have paid out all of the \$300,000 which it had in its treasury at the beginning of the strike in "strike wages" and is now seeking contributions in the colonies and even in the United States. The total outlay in support of the striking workmen already exceeds \$1,000,000. The English correspondents of leading American papers all say that the labor union is virtually defeated and must accept the employers' terms, but it continues to reject these terms and, after six months of resistance, seems to be as far from defeat or compromise as at the beginning.

Doubtless such conflicts are inevitable and will occur from time to time in all manufacturing countries. In spite of what the sentimentalist teaches there is and will be to the end of the world a conflict, or at least a certain antagonism, between the wage working and employing classes. Their interests are consonant in some things but in others they are antagonistic.

One of the most prominent and able of the labor leaders of this country said at a national convention in New York a year ago: "What we really want is the highest wages possible for as little work as possible." On the other hand the employer wants the most work for the least wages. To help enforce their ideas employes organize unions to hold up wages, lessen hours of labor and limit the amount of work which each man may perform in a given time. The employer seeks to diminish the wage portion of his outlay by introducing labor-saving machinery. It is true that the natural antagonism of the two classes is modified by many influences, but it exists and always will exist, unless our "reformers" succeed in eliminating human nature from the people of the future. Occasionally great conflicts will break out, but during most of the time in the future, as in the past, the necessities which compel one class to labor and the other class to treat labor so that it will be truly profitable to them, and the thousand gracious influences which proceed from education and the gentler instincts will preserve for the greater part of the time harmony between them, and insure mutual progress and joint benefits.

THE Interstate Commerce Commission has extended the application of the Safety Appliance law for two years to all those who petitioned. This action is, taking all things into consideration, about the wisest that could be taken, and has been quite favorably received.



NOTES OF THE MONTH.

The "Moral uses of Machinery; the Modern Pentecost of Tools, Not Tongues" was the subject of a very suggestive sermon given several months ago by a prominent Chicago divine, the Rev. N. D. Hillis. While the sermon is now old its substance has an ever present value and we append some extracts to indicate its trend. Dr. Hillis said, in part: "Strangely enough, in this era when tools have emancipated men from slavery, men have risen up to assert that machines are creating a new form of servitude. The eminent author and orator, Bishop Potter, has just affirmed that labor saving machinery is a curse to laboring men. Once slavery was patriarchal, now it is said to be industrial; once the machine was the accident of the man, now man is the mere incident of the machine. Bishop Potter reminds us that the time was when the shoemaker toiled over his last during the morning hours, spent his afternoon in the orchard and garden, his evening at the town meeting or with the school board, his Sundays in worship and reflection, and was at once workman, worshiper and student."

Taking up an analysis of the statement that machinery is an enemy to happiness and is destroying individuality and character, Dr. Hillis contended that this statement "is misleading, and quite aside from the facts in the case, calculated to disturb the happiness of each workman and to embitter his life. So far from tools degrading men they represent the uttermost of kindness and divine benefaction. By reason of the ignorance and error of past generations it happens that very few men are possessed of genius and greatness. There are a few ten-talent men, a few five-talent men, more two-talent men, while most of all represent one-talent. Now, in an age when civilization has become complex and highly organized, the great multitudes representing one talent are in danger of falling out of the race. The strong and wise advanced so swiftly that the one-talent man could not keep up. Nor was he able to work with sufficient rapidity to hold his place. Now, in the interest of this one-talent man, inventors were raised up to create tools."

To illustrate the working of this truth the doctor says: "To make a modern shoe requires sixty different workmen. From these sixty different tasks the one-talent workman selects something he can do, and, doing that one thing, he, too, becomes a creator, retains his self-respect by being a producer, and where without tools he would have been heartbroken, with his tools he stands upon his own feet and makes his own contribution to our civilization. Fulfilling the promise that 'the bruised reed I will not break' God gave the tool as an act of uttermost tenderness and kindness."

Continuing, to show how machinery multiplies blessings he said: "Search all modern life through and there shall not be found one single element that represents a form of ministry to the weak and the poor, that is so beneficent as the fact that machinery hath so divided toil as to enable the humblest man to become a self supporting worker, and have his own place in civilized life. And when the tool has made a place for the one-talent man through nine hours of toil, it goes on to give him four times the wage that his father enjoyed, by means of which he purchases a newspaper, the book, the picture, the ride to the park or lake or into the country—influences that redeem him from drudgery and obscurity, and make him the child of variety and growth. For the occupation and tools are teachers, not less than the church, the library and the school house. For in God's providence the working classes are to achieve their progress by means of tools."

The doctor's closing prediction is strong and cheering. He said: "Within the next century, it is believed, tools are to make the school and the college as free and as open for young men and maidens as public schools are now for boys and girls. Machinery is to increase intelligence and refinement;

to put comforts and conveniences with instruments of beauty with those now called the poor and the weak. Through machinery, wealth that now like snow sometimes comes together in drifts, is to be diffused and scattered evenly over the land. Increasingly freeing men from toil, tools are to give men leisure for study, travel, philanthropy, reform, christian service and sympathy."

The results of mechanical tests of 32 species of American woods, made by the Forestry Division of the United States Department of Agriculture, are shown in the diagrams herewith. The tests made were elaborate and exhaustive, and were supervised by Prof. J. B. Johnson of Washington University. Mr. B. E. Fernow, chief of Forestry Division, in reporting upon them states that the fact that within the same species the strength of wood varied with

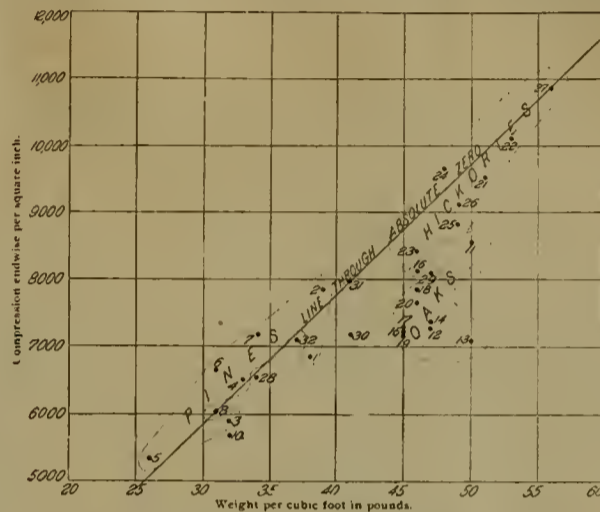

RELATION OF STRENGTH IN COMPRESSION ENDWISE TO WEIGHT OF MATERIAL.

the dry weight—that is, the heavier stick is the stronger—has been known for some time, and, in fact, is true, not only for a given species, but also for the four principal pines of our southern states. This fact is of practical importance, for these species are indistinguishable by anatomical structure. Accordingly Mr. Fernow recommends inspection by weight, other things being equal, disregarding species determination.

While this result of the exhaustive series of tests reasonably well demonstrated for these pines may be considered of great practical value, Mr. Fernow states that we can now extend the application of the

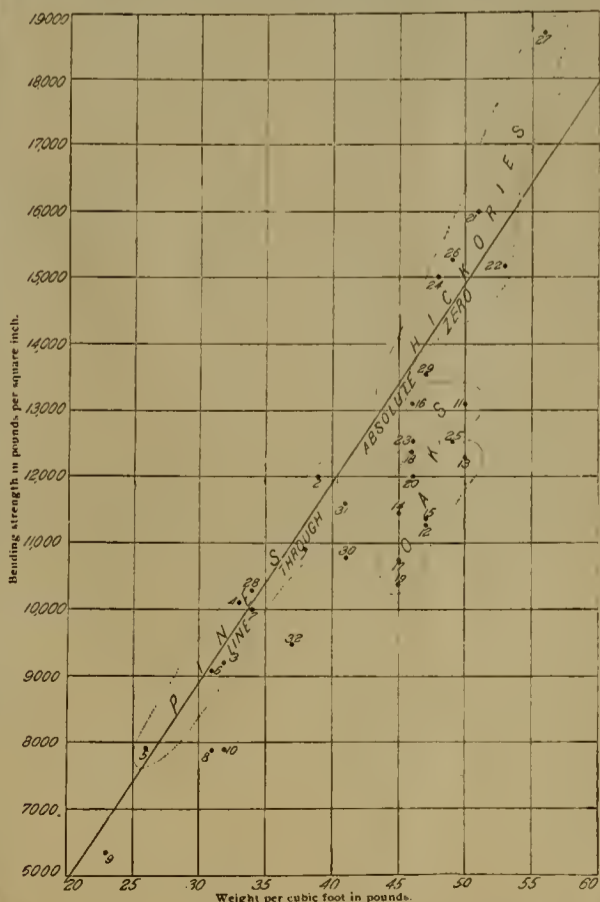

RELATION OF WEIGHT TO BENDING STRENGTH AT RUPTURE.

law of relation between weight and strength a step farther, and state as an indication of the tests that probably in woods of uniform structure strength increases with specific weight, independently of species and genus distinction, i. e., other things being equal, the heavier wood is the stronger. He is at present inclined to state this important result with caution, only as a probability or indication, until either the test material and tests can be more closely scanned, or a more carefully planned and minutely executed series of detail tests can be carried on to confirm the truth of what the wholesale tests seem to have developed.

In the two diagrams the average strength of the different species in compression endwise and bending has been plotted with reference to their calculated weight (specific gravity). Considering that these tests and weight determinations (especially the latter) were not carried on with that finesse which would be required for a scientific demonstration of a natural law, that other influences, as crossgrain, unknown defects, and moisture conditions may cloud the results, and that in the averaging of results undue consideration may have been given to weaker or stronger, heavier or lighter material, the relation is exhibited even by this wholesale method, says Mr. Fernow, with a remarkable degree of uniformity bordering on demonstration. An exception is apparent in the oaks in that they do not exhibit this relation of weight and strength with reference to other species, and also with less definiteness among the various species of oak in themselves. The structure of oak wood being exceedingly complicated and essentially different from that of the wood of all other species under consideration, it may reasonably be expected that it will not range itself with these.

The species of woods tested are indicated by numbers in the diagrams, as follows:

No. Species.	No. Species.	No. Species.
1. Longleaf Pine.	13. Post Oak.	23. Water Hick'ry
2. Cuban Pine.	14. Cow Oak.	24. Bitternut
3. Shortleaf Pine.	15. Red Oak.	Hickory.
4. Loblolly Pine.	16. Texan Oak.	25. Nutmeg Hick-ory.
5. White Pine.	17. Yellow Oak.	
6. Red Pine.	18. Water Oak.	26. Pecan Hick'ry.
7. Spruce Pine.	19. Willow Oak.	27. Pignut Hick'ry
8. Bald Cypress.	20. Spanish Oak.	28. White Elm.
9. White Cedar.	21. Shagbark Hick-ory.	29. Cedar Elm.
10. Douglas Spruce.		30. White Ash.
11. White Oak.	22. Mockernut	31. Green Ash.
12. Overcup Oak.	Hickory.	32. Sweet Gum.

The most important practical result of these tests, if farther study and tests substantiate them, is, says Mr. Fernow, that we have given into the hands of the wood consumer a means of determining the relative value of his material as to strength and all allied properties by a simple process of weighing the dry material—of course, due regard being given to the other disturbing features like crossgrain, defects, coarseness of grain, etc.

Journal bearing metals have caused no little trouble for a great many years past. And it goes without saying that some well defined method of satisfactory analysis should be acquired. Mr. W. E. Garrigues, in a paper recently presented to the chemical section of the Engineers' Club of Philadelphia, very thoroughly covers the whole matter of analyzing bearing metal alloys and explains a new volumetric method for determining copper. The paper is too technical for advantageous use in our columns, but we would suggest that our friends amongst the various railroad testing laboratories should look it up in the original. There are two points, however, worthy of note here that appear in the opening of his paper: one is that in treating with these bearing metal alloys we are not considering a material capable of being handled like steel, where accurate methods have been found for ascertaining the quantity of almost each element present without the necessity of first removing three or four others from solution. Another point that he makes is one that will appeal to railway master mechanics, and is to the effect that



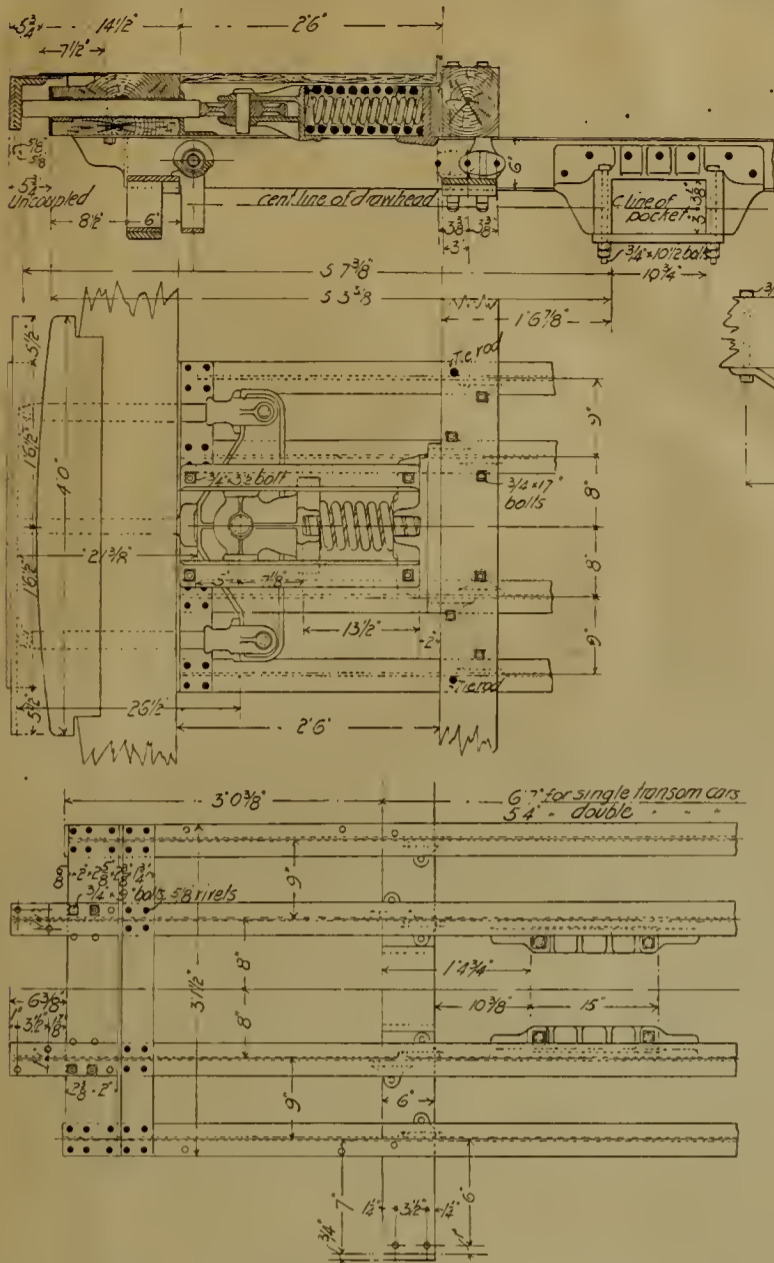

FIG. 3.—GREAT NORTHERN VESTIBULE.—PLATFORM DETAILS.

the Great Northern people in a later issue. The designs on this vestibule were gone over repeatedly by Mr. H. H. Vaughan, mechanical engineer of the road, under the supervision of Superintendent of Motive Power Pattee, the management having been particularly anxious in this case to get the standard into the most satisfactory shape before adoption. Our engravings show the adopted design in considerable detail. As before intimated we hope

rotated at a very high speed, we very often find that the shellac or varnish is thrown off from the wheel by centrifugal force. From the appearance of the painted surface, it seems that the gum is a semi-fluid, and that when some heavy pressure is applied, like the pressure of centrifugal force in a high speed wheel, it causes the material to flow. The motion of the gum over the surface of the wheel takes place slowly, as an hour or more is sometimes required for the varnish to move from the surface of the rotating wheel and escape at its periphery.

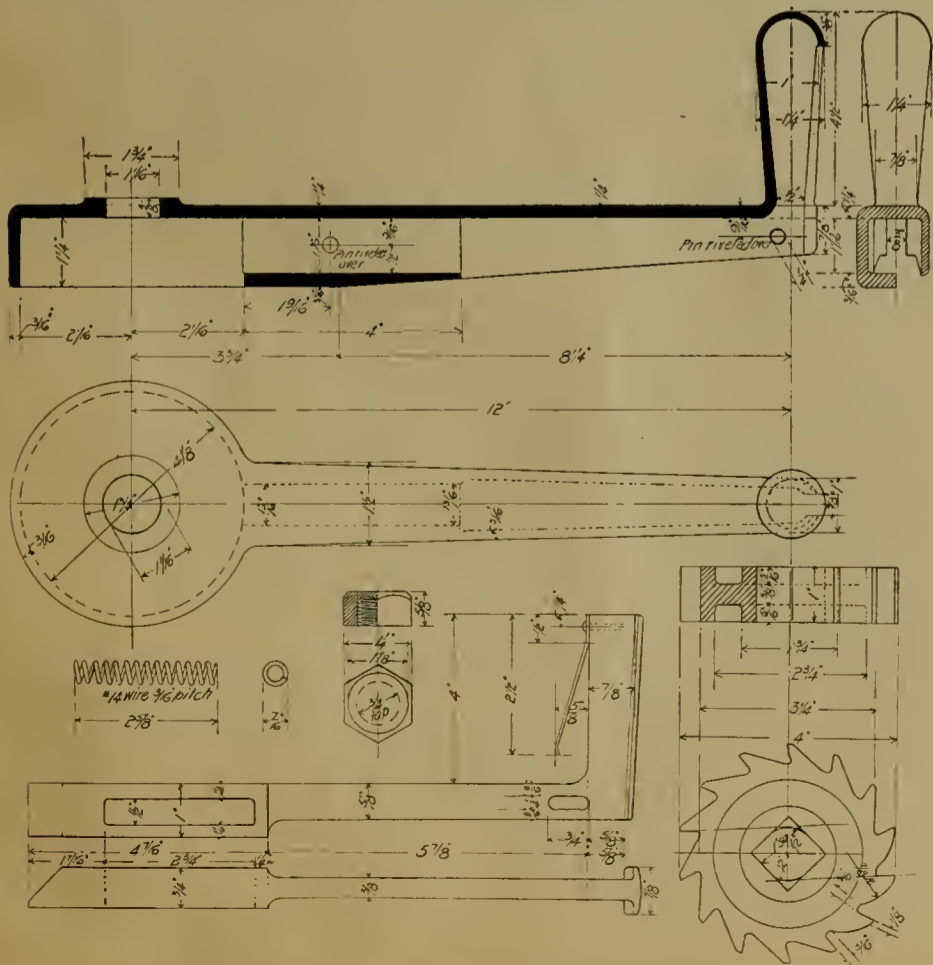
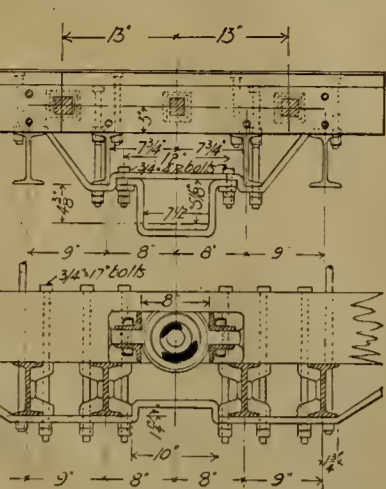

FIG. 5.—GREAT NORTHERN VESTIBULE.—BRAKE ARRANGEMENT.



to later present some interesting data concerning the study of clearances involved.

### SOME PHENOMENA OF HIGH SPEED ROTATION.

Under the title above given, Mr. Jas. F. McElroy, the well known consulting engineer of the Consolidated Car Heating Company, presented a paper some time ago before the Albany Institute. The phenomena which he treated of were those connected with high speed rotation as observed while engaged in the development of a steam turbine running at very high speeds. Without giving Mr. McElroy's remarks concerning the principles of construction and performances of the steam turbine, or an account of his interesting experimental work with that promising device, we present a few extracts concerning high speed rotation in general:

If a wheel be covered with shellac or varnish, which is allowed to become hard and dry, and if then the wheel be rotated at a very high speed, we very often find that the shellac or varnish is thrown off from the wheel by centrifugal force. From the appearance of the painted surface, it seems that the gum is a semi-fluid, and that when some heavy pressure is applied, like the pressure of centrifugal force in a high speed wheel, it causes the material to flow. The motion of the gum over the surface of the wheel takes place slowly, as an hour or more is sometimes required for the varnish to move from the surface of the rotating wheel and escape at its periphery.

Indeed, the cohesive and adhesive forces of ordinary substances are not sufficient to withstand any except the lower range of speeds of the steam turbine. Even the finest grades of steel wheels can be torn apart when exposed to the unbridled action of the steam jet. For this reason, all kinds of materials may be arranged in the order of the exploding points of samples of such material when made in a fixed form. The number of revolutions at which material of a given size and form will explode would depend upon the specific gravity and upon the tensile strength of such material. Almost all ordinary materials would be found to explode at comparatively low rates of speed. Only the finest quality of steels are able to stand the strains due to a speed of 30,000 revolutions per minute, which is the rate at which a 6 in. wheel will revolve most economically when driven by a high pressure steam jet. Indeed, it is very difficult to build a turbine wheel, even when using the finest quality of steel, and prevent stretching of the metal due to centrifugal force.

In the construction of apparatus for high speed rotation a peculiar difficulty is met with in a vibration in the turbine shaft, which is set up entirely apart from its rotation proper. This vibration occurs at fixed intervals, separated by several thousand revolutions, and occurs whenever certain rates of speed are reached, whether by increasing from a lower or decreasing from a higher speed.

The form of this secondary vibration, in a more or less flexible turbine shaft, somewhat resembles the motion which takes place when children play "jump the rope." In this case, however, the different particles of the rope are simply made to describe circles of different diameter, while in the turbine shaft the same motion accompanies a rapid rotation on its axis. Perhaps fifty revolutions may take place on its axis for each secondary revolution. This secondary vibration is generally attributed to vibration due to imperfect construction of the wheel, and its mounting on the shaft. It is generally claimed that the center of gravity does not correspond to the center of the shaft itself. As it would undoubtedly revolve around its center of gravity, the shaft would then be caused to rotate in an eccentric manner, and thus produce a side vibration.

From what I have seen of this secondary vibration, I do not believe that the above explanation at all explains the phenomenon. If the above explanation were true, the vibration of the shaft would occur at all possible speeds, whereas, as a matter of fact, the vibration only occurs at certain fixed speeds, and the wheel will run silently and smoothly at other speeds. Again, if the explanation as above outlined were true, the vibration would be at the same rate as the revolution of the wheel, whereas, as a matter of fact, the wheel will make a large number of turns for one single excursion of the shaft, so that the vibration of the shaft is easily followed by the eye, whilst its revolution is invisible.

I have repeatedly observed that the turbine wheel will revolve in silence, and will require no more than one pound of steam to drive it, so long as its speed is kept within the limit of about 3,500 revolutions per minute. But when we attempt to force its speed above this rate, the wheel begins to vibrate and springs the shaft sideways from 1/4 to 1/2 in., at which time the wheel is liable to strike the turbine casing with considerable force. The direction of motion of the flexible shaft depends upon the direction of rotation of the turbine wheel, it always being a progressive rotation, that is to say, the convex side of the shaft, when sprung to one side, always moves forward in the same direction as that part of the shaft rotates. After passing the critical speed, when the secondary vibration occurs, the turbine wheel will at once settle down and run quietly, without noise or vibration, until its speed is very nearly doubled, when the wheel will again begin to vibrate and difficulty will be found in forcing it to a higher rate of revolution. Between the critical points where the wheel and its shaft vibrate violently, the wheel will continue to run quietly and without the consumption of a very large amount of steam. It is, therefore, necessary, in determining the speeds at which turbine wheels should be run, that the speeds be fixed at a point where the turbine will run quietly, and not run the turbine near the critical points at which violent agitation takes place. On reducing the speeds the same agitation takes place as these critical points are reached from the higher speed, and the agitation of the wheel is sometimes sufficient to threaten the destruction of the apparatus.

Some light may be thrown upon this phenomenon by the similar motions of a top at various speeds. It is true that the velocity of rotation of the top is very much less than that of the steam turbine wheel, but this only causes the same phenomena to appear in the steam turbine wheel in a more exaggerated and violent form. Some of the motions of the top may, no doubt, be explained by gyroscopic rotation, but there are other motions, which also belong to the steam turbine, which, it appears to me, cannot be thus explained.

It seems to me that the top, in which the small boy takes such delight, exhibits some of the most profound questions known in the mechanics of motion. Some of these questions may be answered to the satisfaction of the mathematician, but to the great mass of people these matters are puzzling and impossible of satisfactory explanation. To the thoughtful mind the question naturally suggests itself, as to why does the top always stand on end, with its axis vertical, and the plane of rotation horizontal? Again, when the axis of the top is inclined to the vertical, why does it revolve slowly around a new axis while turning rapidly upon its own axis, and, when so inclined, why is it that it gradually rights itself until it revolves in a horizontal plane? In my judgment the top is worthy of being elevated to the dignity of a true scientific instrument.

The troublesome and almost destructive character of the secondary vibrations set up in rapidly revolving bodies makes it necessary to adopt some means of preventing or modifying them. I was surprised to find that when the shaft was vibrating violently the vibrations could be very much reduced and the shaft forced out of its critical period by gently pressing against the shaft with a piece of wood. We afterward adopted the expedient of placing a composition ring in a cushioned support around the shaft, the opening through the ring being made so that the shaft would not touch except when it began to vibrate. In this way the violence of the vibrations was very largely overcome, and the critical periods could be more safely passed.

The use of ball bearings in a steam turbine is hardly

permissible except in temporary and experimental apparatus. I have found it impossible to make, without case hardening, a surface in the ball bearing upon which a line of balls are to be run at the speed necessary to be employed in steam turbines, without the balls spinning a groove in the solid steel. In one of our earliest experiments we constructed a thrust bearing which carried a weight of about  $3\frac{1}{2}$  lbs., including the weight of the turbine wheel and shaft and the connecting wheels. The shaft extended through a hole in this bearing, and a line of steel balls traveled around in a circle half an inch outside the hole through the steel. Notwithstanding the

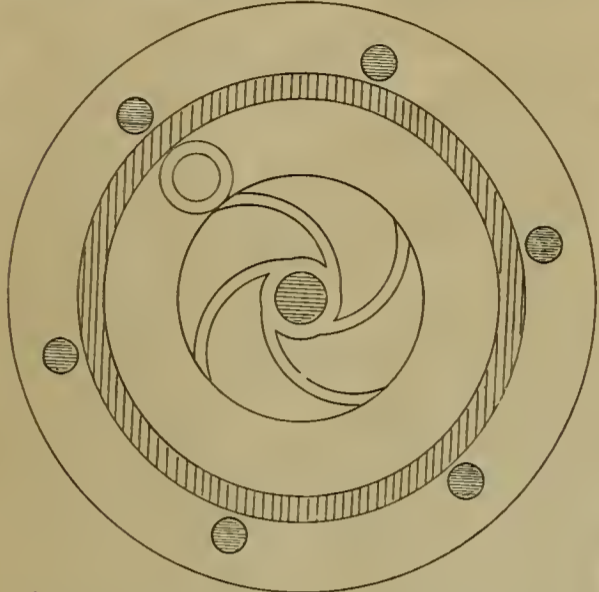

Fig. 1.

bearing was made of a piece of machinery steel, of  $2\frac{1}{2} \times 1\frac{1}{2}$  inches of solid metal, the travel of the line of balls carrying a comparatively light pressure spun a path in the steel, and spread the solid metal so that it reduced the size of the opening through it until it took up all the free space around the shaft, and then tightened up on the shaft until it brought the steam turbine to a standstill. We found considerable difficulty in removing the steel shaft from the opening through the plate. From my observations of these experiments, I am inclined to believe that a mass of steel of considerable size may be worked, if acted upon by a spinning tool of sufficiently high velocity.

I will say finally, that in the construction of steam turbines, and other machinery intended to be run at extraordinarily high velocities, the phenomena which are hardly noticeable at ordinary speeds may become highly objectionable, or may be turned to useful account. An illustration may be given as follows: A circular disk of steel, 5-16 of an inch in thickness, and  $1\frac{1}{8}$  inches in diameter, was used as a thrust plate, in our completed turbine to carry the weight of the revolving wheel. Small curved grooves about 1-16 of an inch wide by 1-16 of an inch deep were then cut in this rotating disk on opposite sides from center to circumference. Stationary upper and lower bearing plates were placed on opposite sides of the disk, and these

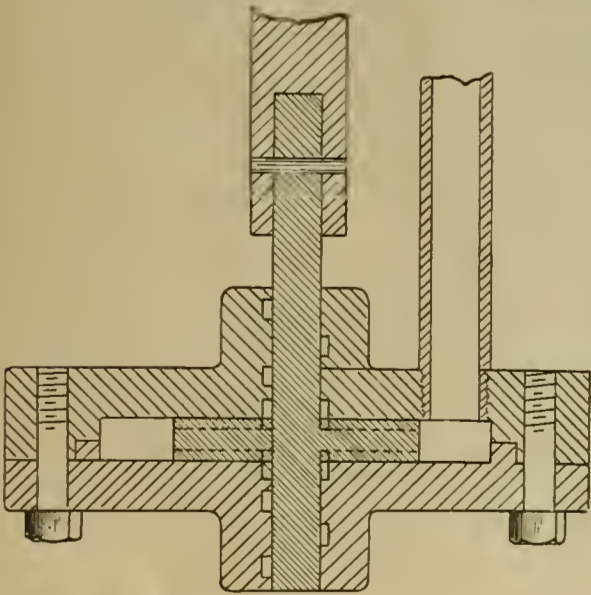

Fig. 2.

plates also carried the journal bearing for the shaft. Spiral grooves were cut in both top and bottom journal bearings so that oil could reach the center of the disk. The steel disk with the bearing plates bolted together was placed in the bottom of a cast iron pot in the turbine casing, and then the pot was filled with oil. There would, of course, be a tendency to throw oil radially from the center to the circumference of the groove in the steel disk. This was then connected up with a small pipe leading from the space surrounding the edge of the disk, so as to carry the oil into the upper bearings of the dynamo and engine. We found that this little centrifugal pump (see Figs. 1 and 2) had sufficient power not only to supply the bearing with oil, but it could lift oil 22 ft. high in a solid column, filling a  $\frac{1}{4}$  inch pipe.

\* \* \* \* \*

Recurring directly to the steam turbine, in closing Mr. McElroy expresses himself as having "great faith in the future of the steam turbine, as it provides a source of power more simple, and mechanically quite as efficient, as the ordinary reciprocating engine of the same power."

#### ELECTRIC CRANES AT CREWE.

As a contribution to the discussion on a paper on "Electric Cranes and Lifts", presented to the Institution of Civil Engineers by Henry W. Ravenshow, a written communication was sent to that society by Mr. F. W. Webb, mechanical superintendent of the London & North-Western Railway. The methods employed at the wonderful Crewe works always command an unusual degree of interested attention and we therefore give the substance of Mr. Webb's discussion, as we find it in the Proceedings of the society:

Mr. F. W. Webb remarked that the traveling cranes in the Crewe works, some 53 in number, had been constructed for rope or cord driving, and, generally speaking, the results had been satisfactory, although loss in power was inherent to the system. He had early felt convinced that electric power might be applied with many advantages; it was not, however, until the latter end of 1889 that a somewhat serious accident occurred to a workman due to the breaking of a cord running at a speed of about 5,000 ft. per minute, which induced him to substitute experimentally electric power for the cord in one of the cranes. The new system had been put to work in the early part of 1890 with such encouraging results that he had since applied it to nine others, and he anticipated that in the course of a few years all the cranes at Crewe would be electrically driven. Of the 10 cranes altered two had each a lifting capacity of 4 tons, three of 10 tons, one of 15 tons, and four of 30 tons. The motors, switches, and other electric apparatus, which were constructed at Crewe, were all of one type, but varied in dimensions to suit the varying powers required. The armatures were of the Gramme type with Paccinotti teeth. The field magnets were of the Manchester type and were cast in mild steel specially made for the purpose at Crewe. An independent motor was provided for each of the three movements of the crane. In the case of the lifting and long traversing movements the motors were of the same size, but for the cross traversing movement a smaller motor was provided. The magnets were energized three in series from a circuit which was never broken, the current in this circuit being about one ampere and the pressure 120 volts. The movements of the motors, which were reversible, were controlled by switches actuated by three short levers placed immediately in front of the crane attendant. In their normal position these levers stood upright, and they were pushed from him or pulled towards him in accordance with the direction he wished the movement to be made; and in each case the current on the first movement of the switch passed through a variable resistance formed from the scrap charcoal iron left after forming the armature plates. This resistance was wholly cut out when the lever was pulled over. The switch contacts were of carbon, the short ends of arc lamp carbons being used for the purpose, and the same carbon was used for the motor brushes, which had a fixed position in relation to the commutator. All motors were constructed to run at a maximum speed of 1,500 revolutions per minute, a worm and worm-wheel transmitting the movement to the crab gearing. In the case of the 30-ton cranes used in the erecting shops for lifting locomotives, the load was lifted at a speed of 2 ft. 6 in. per minute at an expenditure of 70 amperes at 120 volts. The long traveling was performed at a speed of 100 ft. per minute, with an expenditure of 60 amperes at 120 volts, and the cross traverse at a speed of 50 ft. per minute, with an expenditure of 30 amperes at 120 volts. In the case of light weights the speed of lifting was 10 ft. per minute. In the case of the 15-ton crane, which had been provided in connection with a boiler-rieving plant, the crane was 50 ft. above the floor level, and all its movements were controlled by switches on the ground, a magnetic brake being provided on the armature shaft to arrest the motion as soon as a rivet hole had been brought into place for the closing of the rivet. The cost of repairs had so far been very small; no renewal of commutators had been necessary, but they had to be lightly skimmed up in the lathe about once in 12 months. The carbon switches and brushes had to be renewed once in 6 months, and as this applied to cranes which were very heavily worked the result was considered satisfactory. He took the opportunity of acknowledging the services of Mr. A. M. Thompson, M. Inst. C. E., his chief assistant in charge of the electrical and signaling departments, under whose supervision the work referred to had been carried out.

#### WASHING OUT LOCOMOTIVE BOILERS.

In our last issue we gave the greater part of the very interesting discussion on "Washing out Locomotive Boilers," had before the Western Railway Club. By inadvertence the "to be continued" line was omitted. We append the close of the discussion:

Mr. Smith, (C. M. & St. P. Ry.)—I have not prepared a formal discussion. One thing occurred to me on the question of scale forming from the residue of incrusting solids in the water that has been purified in the secondary tank—it is quite possible that Mr. Mackenzie is using the system of purifying in the boiler without knowing it. That is to say the average chemist would figure slight excess of soda-ash to treat the sulphate of lime present in the water, and that excess would remain still active and would take care of the remaining lime salts after the water gets to the boiler. In that way there would be formed a small amount of mud, instead of scale.

On the general subject of purification in stationary tanks, it may be said that that is the ideal method of furnishing the boiler with perfectly pure water. The method of precipitating by soda-ash and lime is what is known as Clark's process, and it was introduced something like fifty years ago in England. In this process the sulphates are changed to carbonates by the use of soda-ash, and usually remain in the water in solution. If sufficient soda-ash be added, for instance, to Lake Michigan water, to transform the sulphate of lime, there would be no precipitate whatever, the carbonates which would result would be held in solution by the carbonic acid of the water. It is then proper to precipitate those carbonates which are already present in the original water and those formed from sulphates, and that may be done by any method that will remove the carbonic acid gas. Where the water is purified in the boiler it is done by the heat; in the Clark process it is done by the lime, and this lime becomes the chief difficulty in the process; it must be adjusted as to quantity very exactly. The principal depends on the absorption of the carbonic acid by the slaked lime, producing carbonate of lime, which is the same ingredient that we wish to remove from the water. If quantities are correctly adjusted, both the added lime and that previously present are precipitated. If considerably too little lime is used, it happens often that there is sufficient carbonic acid to keep the whole thing in solution, and the purified water is worse than the original water. That has often happened in Clark's process, but it is not the case where the process is carefully watched. It is possible, by very frequent testing, to get most admirable results, the water being practically pure, but at the places where that is done the water is tested every half hour for the excess or deficiency of lime. The lime, of course, is a very crude product, and varied in composition, and in dissolving it a variable quantity comes into active employment; the carbonic acid of the water is constantly varying, and with these conditions the process requires very careful watching; in fact, it constitutes a chief objection to employing it at every country water tank scattered along the railroad.

Mr. E. M. Herr (N. P. R. R.)—If I understand Mr. Mackenzie's explanation in answer to Mr. Forsyth's question, it seems to me that it is hardly fair to say that the cost of this process is nothing except the actual cost of the ingredients which enter into the water. I understand that a settling tank at least equal in capacity to the supply tank is necessary, which of course must be supplied. The water must first be pumped into this tank, remains there to settle and afterward is pumped out, which requires, as I take it, perhaps not double pumping, but at least a larger amount of pumping than the regular pumping service.

The matter of purification of water before it reaches the boilers of engines has always been an attractive one to me, and I think, as Mr. Smith just said, it is the ideal process. My understanding is that it is not in general use because it is quite expensive to handle it so as to produce results which are sufficiently good to warrant its use. I think, if my memory serves me rightly, that Mr. Barr had this matter investigated some time ago, and that was the conclusion reached on the Chicago, Milwaukee & St. Paul road.

The matter of washing boilers and the difficulty with the boilers leaking after washing is a very interesting one and a very important one. I have made quite a study of the proper method of boiler washing and fully agree with Mr. Forsyth that the pressure of water used is an exceedingly important point. I found in investigating this matter not long ago that, in attempting to use hot water, the actual pressure in the hose used was about fifty to sixty pounds, and an examination of the boilers showed that they were very imperfectly washed. I have since substituted other methods, and we are now obtaining a pressure of not less than one hundred to one hundred and twenty pounds per square inch, and the boilers are very much more perfectly washed. There is quite a decided improvement, not only in the appearance of the boilers, but in their performance and in the absence of leaky tubes.

I asked Mr. Mackenzie how hot the water was with which he washed, because the matter of washing with hot water has been of quite serious concern with me; at some points on our line we have no facilities for making the water hot; it is impossible to get hot water, and we are obliged to wash with cold water. On some of those divisions we sometimes have our power run very hard, and I found we were turning out engines very quickly, and sometimes washing them in time which seemed to me inadequate even with hot water. Much to my surprise, however, in looking the matter up, I found that we had a few leaky tubes on that division as on any division on the road, although the water was absolutely cold with which we did the washing. Following this matter up, I thought I discovered that the cause of leaky tubes in boilers was

not alone, or not principally, due to the way in which they were washed, but was largely due to the treatment they received before they reached the washout pits; putting them over a clinker pit, putting the blower on full, and allowing a lot of cold air to circulate through the tubes while the boiler is hot, is in my mind a very frequent and common source of leaky tubes. I think the matter of expense of the secondary tank method should be looked into very carefully. If it can be used for little or no expense, it certainly seems to me the thing to do.

Mr. William Garstang (C. C. C. & St. L.)—The practice on the Big Four Road, of washing out boilers, has been to make on an average of five or six hundred miles between washings. I took the matter up with one of our master mechanics, on a division where we have the best average quality of water, advising him what I had learned in Cleveland and asking him to select a couple of his engines in the freight service, to equip them with surface cocks, to use the cocks four or five times over the division of one hundred and forty miles, and to use the blow-off cocks at each end of the division, blowing out from one gauge to one gauge and one-half of water with each treatment under full boiler pressure. After one of the engines had made its usual five hundred and sixty miles, which was the mileage on that division between washings, the engineer reported the boiler to be washed out. The foreman told the engineer that it was the desire of the superintendent of motive power to make a good mileage between washings of that particular engine and wanted to know if he could not run the engine longer without washing out. He said that he could not, that the engine was dirty and must be washed out. The engine was cooled off, the water let out and the hand-hole plates removed; from one to one and one-half inches of sediment was found in the leg of the boiler on top of mud ring. This satisfied the foreman of the round-house that the engine ought to be washed out, and he reported the same to the master mechanic; the latter reported to me that it was impossible to make over six hundred miles on that division between times of washing out. Not being satisfied with the test, I had our road-foreman of engines go to the division on which the engine was running and have the same engine washed out under his personal supervision; I instructed him at the same time to stay with that engine and make the greatest mileage that it was possible to make between washings. Our road-foreman of engines is an old experienced engineer and fully qualified to judge when an engine ought to be washed out. The first I heard of the engine after the test was begun was after the engine had made nineteen hundred miles and was sent to the shop for examination as to its condition. I think the road-foreman wanted to get home, he was away from home at the time, and I think that he sent the engine to the shops that he might have the opportunity. After removing the hand hole plates and letting out the water, the same amount of sediment was found after the nineteen hundred mile performance, that was found after the five hundred and sixty miles. The question will arise, where did the sediment go?

I think that can be answered, in a measure, if not quite entirely, by saying that the surface cock was used frequently and the blow-off cock was used at the end of each trip. For every day work I think Mr. Mackenzie's method of washing out boilers is a good one. We have been conducting the tests now for seven months on one engine, and we are running this engine an average of four thousand miles between times of washing out. The engine is in heavy freight service. This engine has been in service for fifteen months, and was to be sent to the shop when we began Mr. Mackenzie's method of washing out boilers. Since we commenced that practice, confirming what Mr. Mackenzie says in his paper, the tubes do not leak, the engine is causing no trouble, and we are likely to get eight or ten months more service out of it.

Mr. J. F. Deems (C. B. & Q. R. R.)—It seems to me that the idea suggested in Mr. Mackenzie's paper is worth as much serious consideration as anything that has come before this club in a long time. I believe the statement made, to the effect that just in proportion as the number of times of washing out is reduced, just in that proportion you will reduce the trouble from leaky tubes, is a correct one. I think each road and perhaps on the same road, each division, will have to work out its own salvation. But I think that if we take the idea suggested by Mr. Mackenzie as a general proposition, and work it out in a manner to meet the requirements in each case, this paper is going to be worth as much to the railroads of this country as any paper that has ever been presented before this organization.

COMMUNICATIONS.

Handling Freight Trains Partially Equipped with Air.

To the Editor of the Railway Master Mechanic:

Referring to the editorials in the November issue of THE RAILWAY MASTER MECHANIC, and in the Railroad Gazette, in which both take exceptions to the manner in which this question is handled by the Rock Island system. I wish it to be understood that the practice as outlined in that paper does not apply to the Illinois division of the C., R. I. & P. Ry. only, but to the entire system of almost four thousand miles. The maximum grade of the Illinois division is 5-10 of 1 per cent.; of the Southwestern division 85 ft. and of all other divisions 1 per cent. The grade is rolling,

especially so through Iowa, Missouri, Nebraska and northern Kansas, the road being up hill and down, and full of curves. On the Western division, or Colorado end, many of our grades are 5 to 16 miles in length. Prior to September, 1896, the accidents resulting from trains partially equipped with air brakes, breaking in two and running together, was of such proportions that the management concluded that the men were either careless, or that our rules were not right. At that time we were working under the following rule:

"When freight trains are running with not more than one-half of train equipped with working air brakes, such trains must be held on descending grades from the rear end by hand brakes; also when approaching stations or other stops (except emergency cases), the slack must be kept out of trains by use of hand brakes, that is to say, brakes shall be set on the rear sufficiently to avoid the slack running up when application of air may be made by the engineman. Enginemen must use the greatest care in applying air brakes to prevent unnecessary jerking of train, breaking in two, etc. When train is all, or more than half, equipped with air brakes in working order, the engineman will control its movements with air brakes."

This rule was in force for some five years, and seemed to be a step in the right direction, but our accidents did not cease. Investigations brought out the fact that the train and engine men were carrying out the instructions contained in the rule. It was argued by some that the braking by hand should commence next behind the last air car, the argument being that, by holding a train from the rear, links, pins and draw-bars would be broken and pulled out. After inquiry among other roads, to see what our neighbors were doing and what the results were, it was decided to make a series of tests to see what was needed to put a stop to the evil from trains partially equipped with air breaking in two and running together. It was agreed that if all freight equipment was equipped with air there would be no need of any argument. These tests were made first on one division and then on another, beginning with the divisions of lower grades and straight track and ending with divisions with heavier grades and crooked track. The results showed that by holding trains from the rear as prescribed in our rule 587 the correct course had been pursued. We had not, prior to the adoption of this rule, kept a record of all cases of break-in-two, showing their cause, etc., but had a record showing cases of trains breaking in two and parts colliding.

The following statement speaks for itself:

STATEMENT SHOWING NUMBER OF TRAINS BREAKING IN TWO DURING THE MONTHS OF SEPTEMBER AND OCTOBER, 1896 AND 1897.

	Number of trains breaking in two.		Decrease.	Per cent Decrease.	Total number of trains run.		Increase.	Per cent in Increase.	Per cent of breaks to total trains run	
	1896	1897			1896	1897				
Sept.....	220	57	163	74.09	7,414	8,337	923	12.45	2.97	0.68
October	156	55	101	64.74	8,810	9,048	238	2.70	1.77	0.61
Total.	376	112	264	70.21	16,224	17,385	1,161	7.15	2.32	0.64

This covers the first two months of the first and second years of the operation of the rules relative to handling of part air brake trains, now in effect.

Total number of trains broken apart and the parts colliding for the entire system during the year ending Sept. 1, 1896 24

For the year ending Sept. 1, 1897, but one case occurred of train parting followed by collision of the parts 1

Per cent of decrease in year ending Sept. 1, 1897 . . . 95.83

It will be noted that in September and October, 1896, the first two months after the adoption of this rule, there were 376 trains breaking in two, while during the same months in 1897, one year after the rule had been put in force, we had 112 trains breaking in two, showing a decrease of 70.21 per cent; during the same period in 1896 the percentage of the break-in-twos to total number of trains run was 2.32 per cent, while in 1897 this percentage was but 0.64 of 1 per cent, a decrease of 1.68 per cent, notwithstanding 1,161 more trains were run during the two months of 1897 than during the same months in 1896. The figures given are correct and show that we have accomplished the desired result. This result has been obtained with practically the same force of men, we having employed but few new men and those only during the heavy grain movement in August, 1897.

Quoting THE RAILWAY MASTER MECHANIC: "Supposing that, in accordance with the suggestions made, the slack be held out by a few hand brakes set on the rear end, the engineman makes an application with air brakes of the forward end, if these are of any considerable number the forward end would be much more heavily braked than the rear end, and the slack between would run in with considerable violence." How much more violently would the slack run in if there were no brakes on the rear end? From tests made I can answer this by saying that without rear brakes set the shock was sufficient to knock a man down who was not looking for the same, while with the rear hand brakes set the shock was hardly perceptible.

Referring to the argument that with the brakes set on the rear the engineman waits a very long time until the hand brakes are released, we find that we are not experiencing any delays by reason of this. It takes a brakeman but a short time to release the brakes. It would seem

that it is the opinion that all, or the greater part, of the hand brakes must be set. This is not a fact, as on a piece of track of 1 per cent grade it has been demonstrated that with a train of fifty loads, five hand brakes hold the slack out sufficiently.

Relative to pulling the train in two by reason of the hand brakes being set on the rear and the engineman not waiting until they are released, while we have had one or two cases of this kind it has been shown that in every case the engineman handled the train roughly. This can be avoided by giving trainmen time to release the brakes, and by starting the train slowly and not with a jerk, which should be done in all cases. The results obtained by the brakeman giving the engineman the slack of his train to enable him to start at a hard pull are identically the same. It is not argued that with a few hand brakes set on the rear of a long train there will be no slack to the same when the air is applied to the forward portion, but it is claimed that it will lessen the shock sufficiently so that the results at the rear end will not be of a disastrous character, such as piling and breaking freight in the cars, breaking draw gears, throwing the trainmen off their feet, etc. This rule, as stated before, was adopted for the purpose of preventing a collision between the parts of a train broken in two.

With reference to the query as to why a few hand brakes set on the first few of the non-air cars next behind the air, cannot be applied with equal force to the manner in which this rule is applied, we have had many cases of trains parting on descending grade under conditions of weather of such nature that no one had knowledge that the train had parted, and yet but one case of parts colliding since the adoption of this rule. Taking the argument of the editor as to the proper manner of holding a train going down grade, and the necessity arising for the engineman to apply the emergency, it is not necessary for me to state what the results would be under conditions as above stated. With a sufficient number of hand brakes set on the rear of the train the chances are under precisely the same circumstances, that while the two parts may collide the shock will not be of sufficient force to do any damage further than the breaking of a few draw-bars.

With reference to that part of the editorial in the Railroad Gazette which read, "That the rules have worked well on Mr. Nichols' division is not in itself sufficient to guarantee their successful application on other roads. Whether it is a personal element on the C., R. I. & P." etc. In the paper which the editor is criticising, this statement is made: "It might be interesting to follow the course of the management of the C., R. I. & P. in their investigation of this subject as tending to show the foundation for the theory of those who believe in braking behind." It was thought this was plain enough to have all understand that the rule applied not only to the Illinois division, but to the entire system.

In regard to cutting out air brakes in good working order in a train of less than one-half of air brake cars, in order to make air brake cars thus cut out available for hand brakes, and thereby get sufficient power to control the train by hand brakes, and answering the question, "What do we do with the slack on a fully equipped air brake train and why does he not try to stretch it too by hand brakes at the rear end?" the editor has either misquoted or misunderstood that part of the paper which reads, "In case the make-up of the train was such that the non-air cars were insufficient to hold the whole train, air cars were cut out, beginning at the rear, until power enough was available under hand brakes." In case the train is equipped with only one-half air brakes in working order it is safe to assume that there would be a sufficient number of non-air cars to control the movement of the train. In case, however, the train consisted of thirty cars all told, twenty-nine air brakes, under our ruling we would cut out a sufficient number of air brake cars, beginning at the rear, until we did have a sufficient number of hand brakes to control the movement of the train. In case the train is all air it would all be used and the engineman held responsible for the movement of the train.

The allusion to the danger from trains parting among the air had an exemplification within my knowledge at a not very remote date. A train of sixty-one cars, twenty-three air, was ascending a grade at a speed of ten miles per hour, when an air hose burst. The air cars stopped as one, but the thirty-eight non-air cars came up with such force as to throw several of the weakest and lightest cars behind the air to either side. Had this train been on a descending grade with sufficient hand brakes set at the rear this wreck would not have occurred. The conditions in this case were sufficiently similar to a case of train parting among the air to show what the result would be both to the air cars and to the non-air. Bear in mind the disastrous consequences followed in spite of the slow speed and of an ascending grade. How much worse they would have been on level track at greater speed, or on a descending grade with no retarding force at the rear, who can tell!

C. L. NICHOLS,

Supt. Illinois division, C., R. I. & P. Ry.

Blue Island, Ill., Dec. 11, 1897.

[Some comment upon the foregoing will be found in our editorial columns.—ED.]

Some Suggestions About "Fads."

To the Editor of the Railway Master Mechanic:

There was presented at the December meeting of the New York Railroad Club a paper by Mr. R. P. C. Sanderson which, as might have been expected from its title, provoked a more than ordinary amount of discussion. The

subject of the paper. "Fads, Customs, and their Cost," was treated with marked minuteness of detail and while much which the author embodied is true, it was perhaps too sweeping to be tacitly accepted as a whole. Notwithstanding the evident consistency of many of the points it was quite clearly proven at the meeting that the spirit with which any radical departure from accepted lines is usually received is not yet, by any means, dormant.

Mr. Sanderson divided his paper into series of items, some of which it may be well to take up singly with a view to their discussion pro and con. Item No. 1 begins by stating that there is an "absolute immorality of design in most of our smoke stack patterns," and that "a smoke pipe is a smoke pipe and to the properly trained mind looks best in its simplest and most effective form." Concerning this detail there seems to be no room for doubt as to the correctness of his views, and that, as applied to smoke pipes "Beauty unadorned—as he says—adorned the most." There is however a design of smoke stack top which is perhaps of useful as well as ornamental effect. That seen on the Pennsylvania Railroad, for instance, is an example of what is meant: but in line with the solely, would-be, ornate, there is a specimen traveling through the country on one of the oldest of our eastern roads where the top of the stack terminates in a serrated band of sheet metal set on edge around the top and suggesting, every time it comes into view, King Solomon's crown brought down to date and afflicted with the curse of Cain.

Mr. Sanderson says "a cast smoke stack, weighing complete 500 pounds can be produced for from three to four dollars." At even the latter expense it would mean  $\frac{1}{100}$  of a cent per pound! What sort of metal, at that price, there would be in the stack it is difficult to guess. It is unfortunate so far as using them for comparative data is concerned that the relative costs given in parts of the paper,

erated very easily by hand, or may be still more easily by a kick into one of the front corners of the cab, but the trouble is that such manual or pedal act is occasionally forgotten, and then there may be a cracked cylinder or a broken head as a tribute to expensive economy.

A word as to the alleged extravagance and uselessness of general ornamentation. The liking for adornment, either personal or enviroing, is peculiar to human nature, civilized and savage, and is thus an inherent characteristic, and not a fad. The untamed child of nature prefers first, last and always a scarlet blanket to a gray one, and a piece of bright tin to one of tarnished silver. "Looks" has always been a potent factor in influencing decision, often to the exclusion of merit. The inclination towards the decorating of our persons and our habitations is as old as history itself, and varies throughout ages only in kind or extent. Whitewashed walls make a room just as practically habitable as do those of tufted silk; upholstered furniture in our homes is only a fad, for just as comfortable a seat as can be found is the cast iron one of a mowing machine. In short, we are not yet, nor likely to be, ready to abandon our innate, harmless proclivities, and turn away from all those fad comforts which, in a measure, stand between us and the asperities of life.

WM. F. MONAGHAN, M.A.S.M.E.

#### "Useless" Patents, and the Question of "Utility."

To the Editor of the Railway Master Mechanic:

Noticing the comment contained in your last issue upon the question of "useless patents," and the desirability of preventing the issue of any patents save those which will stand the test of "utility" more strictly applied, it occurs to me that there are two sides to this question, and that the comment referred to presents practically but one of

an exclusive right to make, use and vend such an invention. On the other hand, the issuance of patents upon these numerous mechanical monstrosities, if they may be so termed, will most certainly, if they contain anything of value in the way of disclosures or suggestions, result in the development of perfected forms which will be of great use.

It is also worthy of note that the protection afforded by different patents is not always the same, but that in construing them, when they are brought before the courts, the question of practical utility is made of prime importance, and the commercial success of an invention goes far towards the claims advanced by the inventor under his patent. The public is very apt to overlook the fact that it is of the very essence of the contract, of which the grant of the patent is but a part, that the patentee shall make a full disclosure for the benefit of the public, such disclosure being open to all, for all time afterwards, in the records of the Patent Office, and that the disclosure of a new inventive idea, even though clothed by a mechanical monstrosity, may prove of great value in helping along the advancement of the art to which it relates. In consideration of such disclosure the inventor gets exclusive rights for a "limited" time, and the value of such exclusive grant is, on the whole, when he comes to assert it, strictly measured by the degree of utility, or worth, contained in his inventive idea.

Yours sincerely,

PAUL SINNESTVEDT.

#### HEAVY MASTODON LOCOMOTIVE—GREAT NORTHERN RAILWAY.

A locomotive that in many respects is the most remarkable ever built is that which forms the subject

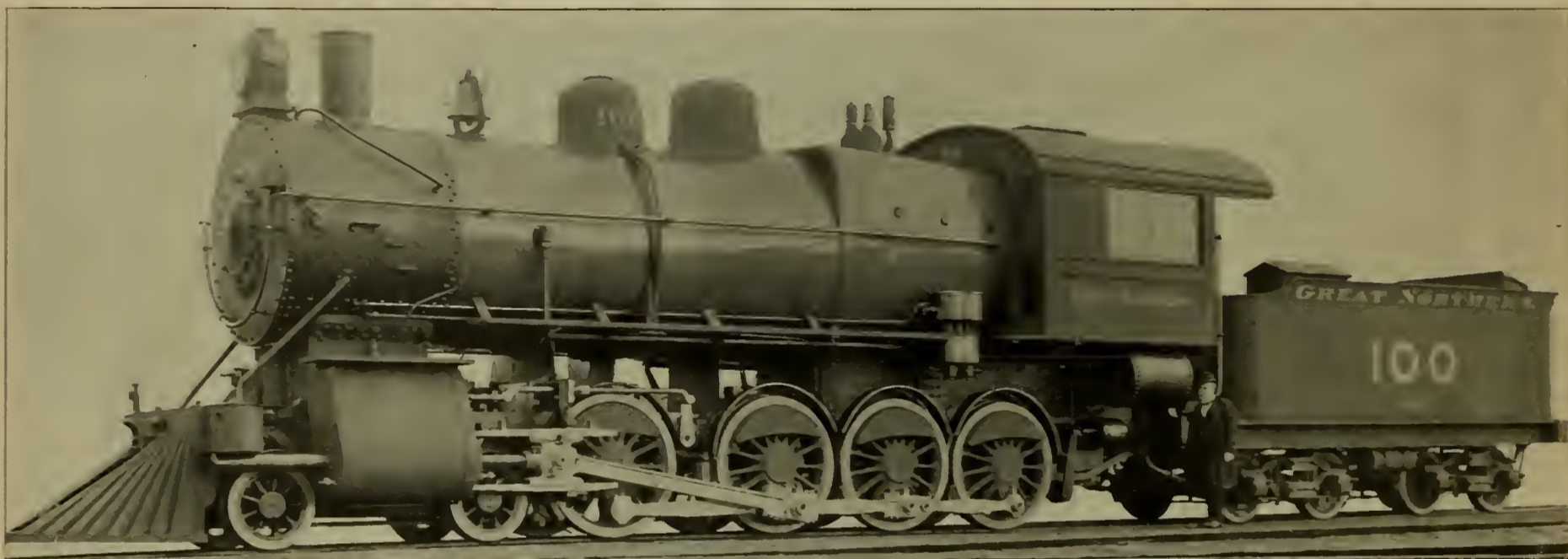

FIG. 1.—HEAVY MASTODON LOCOMOTIVE—GREAT NORTHERN RY.—BUILT BY BROOKS LOCOMOTIVE WORKS.

are based on figures pertaining to a class of labor not general throughout this country, but peculiar rather in that section whence Mr. Sanderson has drawn his conclusions.

In item Number 3 the author inveighs against "combustion chambers," saying that to rob the tubes of from six to fourteen inches in order to get that length of space for a combustion chamber—in view of the utter uselessness of such a space anyhow, owing to the high velocity of the gases—seems like carrying a fad too far. Now such a chamber, if large enough, will certainly improve the combustion, and doing so it suggests the query: Is it not better to more completely consume fuel with shorter tubes than it is to waste it with longer longer ones? Of course if the maintenance of the chamber offset the advantages it is not to be considered at all.

As to his arraignment, in item Number 7 of the practice of fancy painting and gilding on locomotives, he is obviously correct. It does not seem that there can be anything better of its kind in general appearance than a modern well designed passenger engine, rich in its plainness and business-like aspect, and absence of gaudy effect. The writer remembers a case of this loud style of decoration in one of the first locomotives he saw as a child on the Hudson River Railroad, with landscapes and stripings, and in large script letters, running the entire length of the tender, the name "Winfield Scott."

Referring to the paragraph wherein he mentions the use of other unnecessary attachments, there does not appear to be any good reason for classing pneumatic bell ringers and air-operated cylinder cocks among useless accessories. There are on some roads places where a long continued ringing is needed, and where the fireman has all he can attend to, and the engineman certainly has, as well: and if the bell can be made to take care of itself, there seems to be no valid reason for not having it so. As to pneumatic cylinder cocks, if they be of the kind designed to remain open while the engine is getting up steam in the roundhouse, and also during the first movement of the engine by the hostler—a time, more so than later, when they are in need of being open—why is it not a good application of automatic action? Certainly cylinder cocks can be op-

them. It is stated in the article referred to that "there are hundreds of 'freaks' patented continually that are no more use as cycles than canal boats," and that "such inventions are not only useless, but—harmful."

Looking at the above propositions from another standpoint, it seems to the writer that they will be found faulty in several respects. The clause in the United States constitution which authorizes the establishment of the patent law and the issuance of patents to inventors, is grounded on the idea that such laws are primarily for the benefit of the people, that is, the general public, and only incidentally beneficial to the inventors. What the framers of the constitution sought to secure was, to quote the exact language, "to promote the progress of science and the useful arts," and this, as stated, for the benefit of the public. The statutes passed in pursuance of the constitutional provision referred to, require that in order to be patentable an invention shall be new and useful.

It is submitted that there are degrees of utility, and that every individual in the United States, if he investigated the question, would form a different idea as to where the line should be drawn in this matter. It is further submitted, in view of this, that the only successful and practical working plan on which the Patent Office can proceed is to inquire whether there be any degree of utility, however small, and if this be demonstrated, to regard this requirement as satisfied.

The greatest inventions are sometimes first disclosed in mechanical shapes which are little short of abortions, and yet these may contain within them all of the essential inventive elements necessary to complete success. The perfection of the inventive idea becomes then, after such first disclosure, primarily, and almost solely, a matter of mechanical detail and experiment. It is undoubtedly true that many patents are issued, through inadvertence or mistake, upon devices which do not have even the smallest degree of utility called for by the requirement of the patent law, but granting that such be the case, wherein, let me ask, has the general public been in any wise injured? If a thing be useless the public certainly does not suffer by the grant to the inventor, for a limited term, of

of our accompanying illustrations. This engine is the largest and the heaviest that has ever been constructed, if we except the famous Mexican Central double headers, which are, of course, not to be classed with the single locomotives, as they are really a sort of Siamese twins. The present engine was designed by Mr. J. O. Pattee, superintendent of motive power of the Great Northern Railway, in collaboration with the staff of the Brooks Locomotive Works, the builders. The engines were designed especially for very heavy mountain service on 2.2 grades, hauling freight. They have 21x34 in. cylinders, 55 in. drivers, 78 in. boilers, 3,280 sq. ft. of heating surface and 34 sq. ft. of grate area. They will carry 210 lbs. of steam working pressure, and weigh 212,750 lbs., of which 172,000 lbs. are on the drivers. We append a quite full list of the general dimensions in detail.

The heavy weight, the long cylinder stroke 34 in., the longest that we have ever known to be used in locomotive practice, the enormous heating surface, and the combination of these and other hrobdignagian dimensions in a finished machine which still possesses the fine symmetry as revealed in our half-tone perspective of the completed engine—all these combine to make this a truly remarkable engine. The results of its performance in service will be noted with no inconsiderable interest. The fact that it will go into a service which will, as we understand it, be to a considerable extent comparable with that which the heavy compound mastodons are now meeting on the Northern Pacific, will tend to even more closely center attention upon the performance of these later engines. It will be remembered that the Northern Pacific engines, which were illustrated in our issue of April, 1897, were compounds, and the

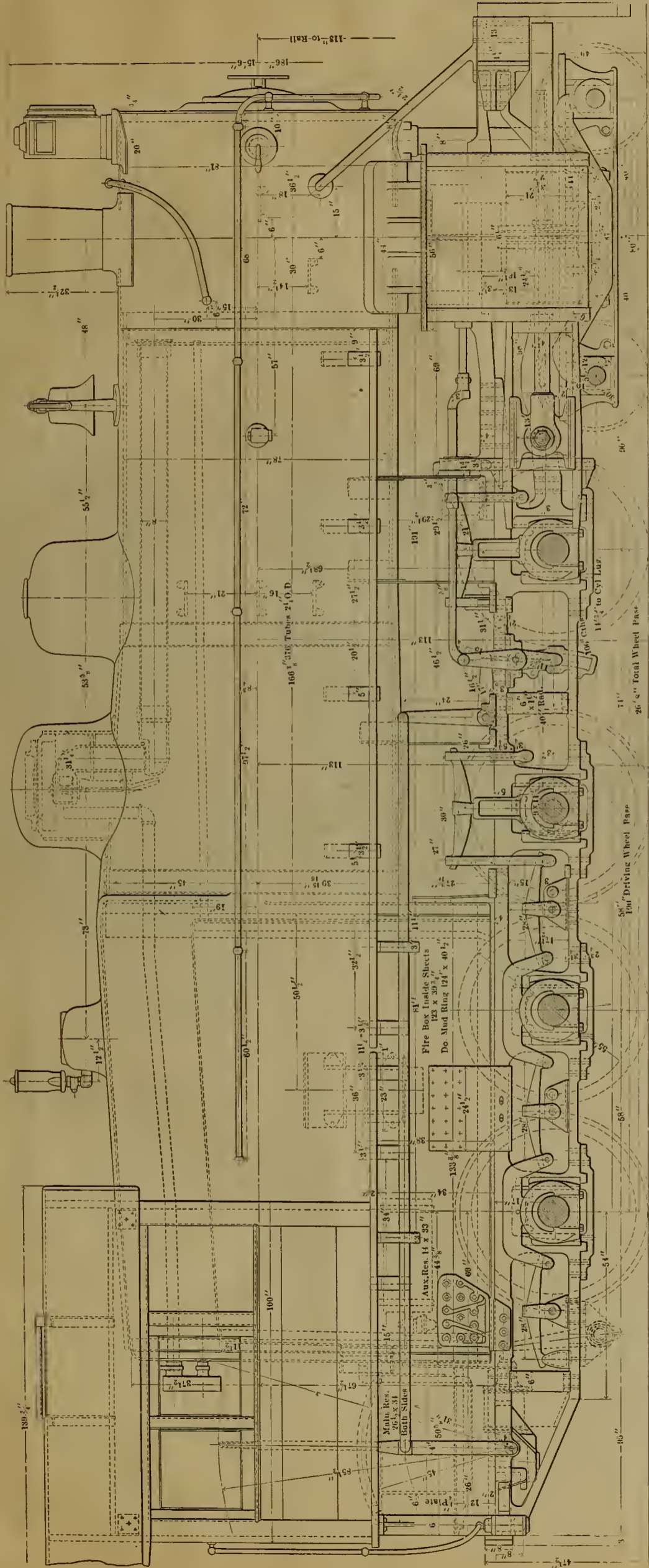

FIG. 2.—HEAVY MASTODON LOCOMOTIVE.—GREAT NORTHERN RY.

comparison of their work with these simples will be probably quite suggestive.

Because of the unusually notable features of this locomotive we have gone quite extensively into their illustration. We show in Fig. 1 the completed engine in perspective; in Fig. 2 a detailed drawing of of the same as a whole; in Fig. 3 a diagram of the distribution of weight; in Figures 4, 5 and 6 the boiler and its detail, and in Fig. 7 a front elevation and sec-

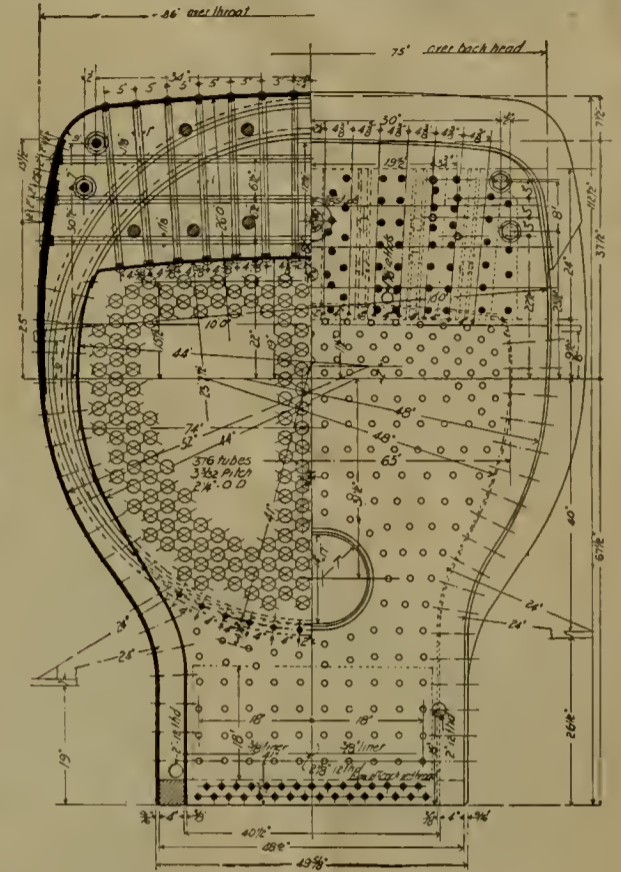

FIG. 5—HEAVY MASTODON LOCOMOTIVE—G.N.RY.

tion. We hope in a later issue to take up the cylinder and probably some other features.

The boiler of this engine is of the Payer patent improved Belpaire type, 87½ in. in its largest diameter and 78 in. in its smallest diameter. Very heavy material, it will be seen, is used in the boiler barrel, ½ in. and ⅝ in. steel being used. The fire box is 124 in. long and 40½ in. wide, and there are 376 tubes, 2½ in. in diameter and 13 ft., 10½ in. long. The heating surface is brought up to a remarkable total of 3208 sq. ft. The boiler, dome, cylinders, steam chests and cylinder saddle are lagged with asbestos, these especial precautions to prevent radiation being taken because of the high altitude and low temperature of of Montana, in which state the locomotives will be

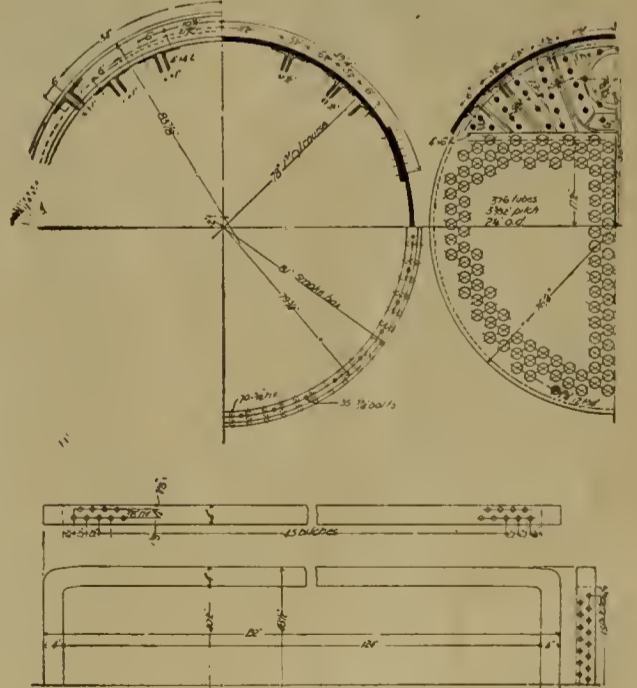

FIG. 6—HEAVY MASTODON LOCOMOTIVE—G.N.RY.

operated. The driving and truck wheel centers are cast steel, fitted with Krupp tires. The valves are of improved piston type and are absolutely balanced. The piston rods are hollow throughout and are extended at the front end. We are giving such complete drawings of this remarkable engine, and append such a full table of general dimensions, that further particularization is unnecessary. We may say, how-

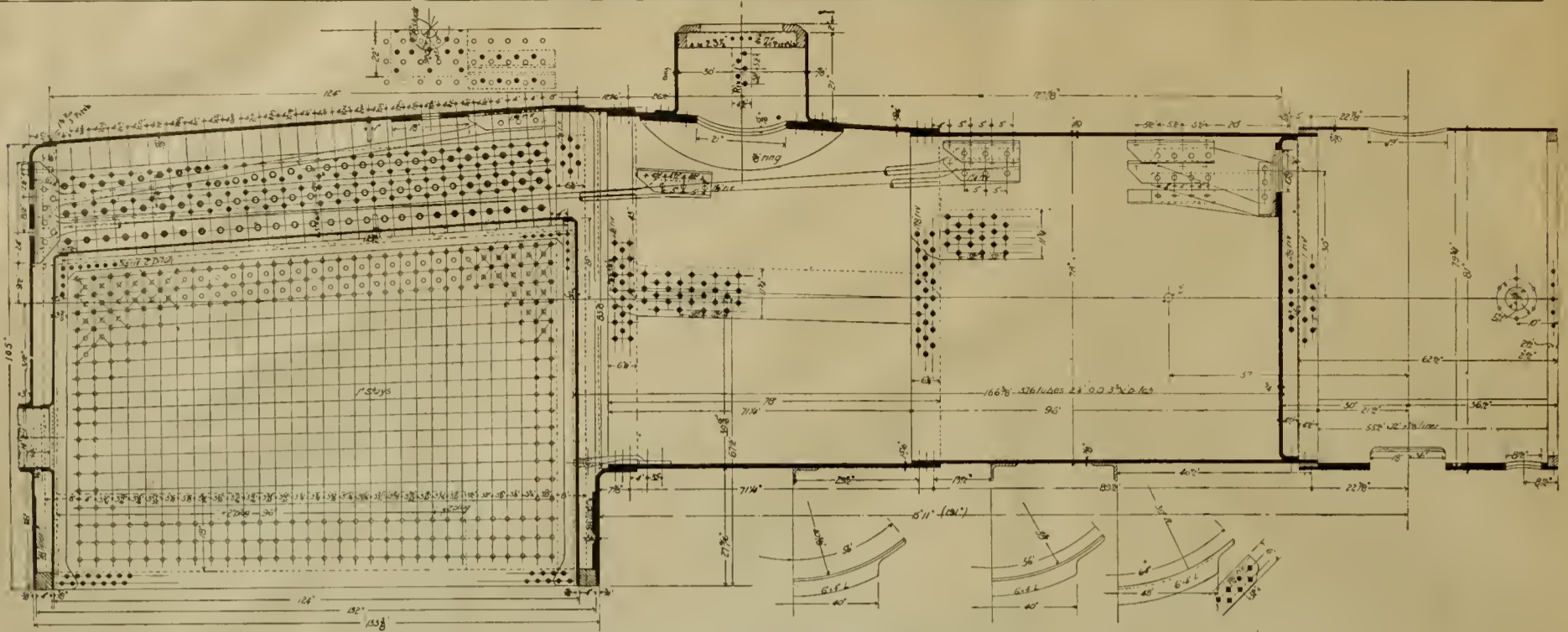

FIG. 4.—HEAVY MASTODON LOCOMOTIVE—GREAT NORTHERN RAILWAY.

ever, that the Brooks works have delivered two of these locomotives to the Great Northern road.

GENERAL DIMENSIONS, ETC.

How many and dates of delivery	Two. Dec., 1897
Gauge	4 ft. 8½ in
Wheel base, total, of engine	26 ft. 8 in
"    "    driving	15 ft. 10 in
"    "    total, engine and tender	54 ft. 3¼ in
Light over all, engine	41 ft. 4 in
"    "    total, engine and tender	64 ft. 1½ in
Height, centre of boiler above rails	9 ft. 5 in
"    of stack above rails	15 ft. 6 in
Heating surface, fire-box	235 sq. ft
"    "    tubes	3,045 sq. ft
"    "    total	3,280 sq. ft
Grate area	34 sq. ft

WHEELS AND JOURNALS.

Drivers, number	8
"    diameter	55 in
"    material of centres	Cast steel
Truck wheels, diameter	30 in. centres cast steel spoke
Journals, driving axle, size	9 x 11 in
"    truck	5½ x 12 in
Main crank pin, size	Main rod bearing, 6½ x 6½ in.; coupling rod bearing 7½ x 5 in.; wheel fit 7½ in. diam. 7 13-16 in.

CYLINDERS.

Cylinders, diameter	21 in
Piston, stroke	34 in
"    rod, diameter	4½ in
Kind of piston-rod packing	Jerome
Main rod, length center to center	8 ft. 10 in
Steam ports, length	18 in
"    width	1¾ in
Exhaust ports, length	50 in
"    width	9 in
Bridge, width	6¾ in

VALVES.

Valves, kind of	Piston
"    greatest travel	6½ in
"    outside lap	1½ in
"    inside lap or clearance	½ in. clearance
"    lead in full gear	0
"    "    "    "    "	Variable

BOILER.

Boiler, type of	Player Patent Improved Conical Connection Belpaire.
"    steam working pressure	210 lbs
"    material in barrel	steel
"    thickness of material in barrel	¾ and 15-16 in
"    diameter outside, smallest	78 in
"    "    largest	87½ in
"    seams, kind of, horizontal	sextuple lap
"    "    circumferential	triple lap
"    thickness of tube sheet	¾ in
"    crown sheet stayed with	improved system direct stays
"    dome, diameter	30 in

FIREBOX.

Type	horizontal over frames
Length	10 ft. 4 in
Width	3 ft. 4½ in
Depth front	86½ in
"    back	79 in
Material	steel
Thickness of inside sheets	¾ in
Brick arch	none
Mud ring	riveting double, thickness 4 in
Water space at top	front 4 in., sides 7 in., back 5 in
Grate, kind of	cast iron rocking

SMOKE BOX.

Diameter outside	81 in
Length from flue sheet	67 in

OTHER PARTS

Exhaust nozzle	single, permanent, 6 in. below center
"    diameter	5½ in., 5¾ in., 5¾ in.
Netting, type of	improved Bell spark arrester

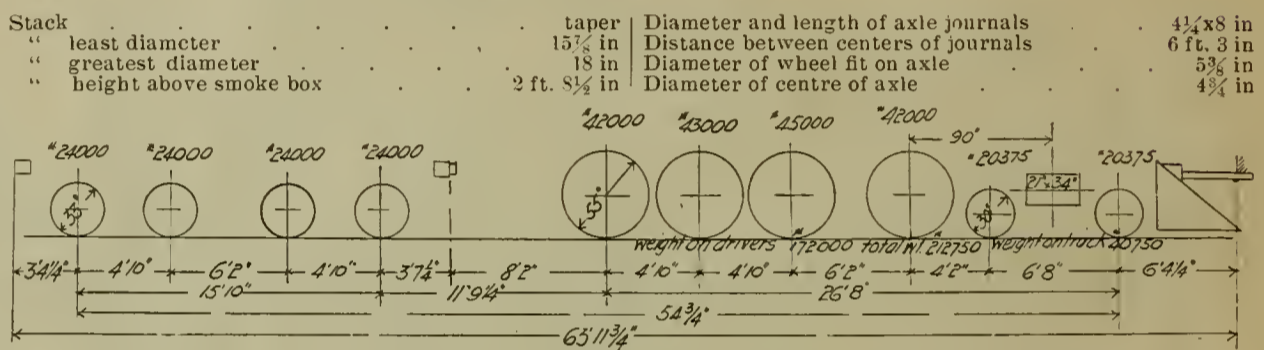

FIG. 3.—HEAVY MASTODON LOCOMOTIVE—GREAT NORTHERN RAILWAY.

TENDER.		NAMES OF MAKERS OF SPECIAL EQUIPMENT.	
Type	swivel trucks	Wheel centres	Pratt & Letchworth
Tank capacity for water	4,670 gal	Tires	Krupp
Coal capacity	10 tons	Axles	Pennsylvania Steel Co. billets
Kind of material in tank	steel	Truck wheels, tender	Krupp No. 4, engine, B. L. W.
Type of under-frame	10 in. channel steel	Sight-feed lubricators	Natban
Type of truck	4 wheeled Great Northern Standard	Couplers	B. L. W.
Truck	rigid	Safety valves	Crosby
Type of truck spring	½ elliptical	Boiler covering	Sall Mountain Asbestos
Diameter of truck wheels	33 in	Sanding device	1 pair Leach double sanders

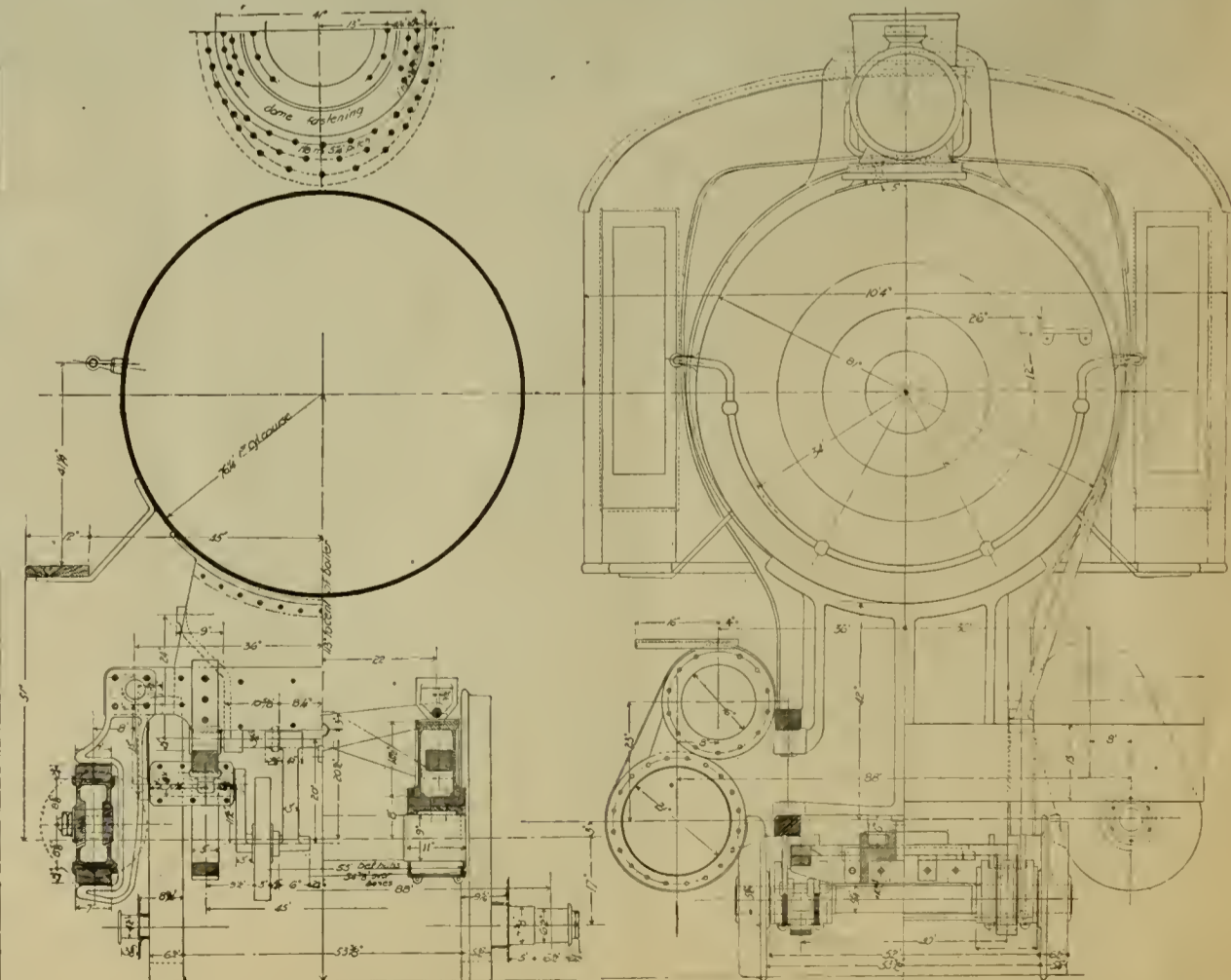

FIG. 7.—HEAVY MASTODON LOCOMOTIVE—GREAT NORTHERN RAILWAY.



Injectors	New Nathan and Monitor O. S.
Brake equipment	New York
Tender brake beam	Monarch
Air pump	New York, No. 2
Steam gauges	Crosby
Whistle	Curran engine
Headlight	Glazier Headlight Co.
Springs	French
Metallic packing	Jerome

**THE PEERLESS HOSE NIPPLE CAP.**

The hose nipple cap shown herewith was invented by Mr. C. H. Dale, president of the Peerless Rubber Manufacturing Company. Investigating the cause of failure of air brake hose, it was ascertained by Mr. Dale that about 90 per cent of the hose of all makes failed at the end of the iron nipple connecting the hose to the train pipe. After devoting several years to a solution of this trouble, Mr. Dale finally struck upon the idea of a rubber cap for the nipple, and has developed this idea to the finished product shown in our engraving. The method of application of the cap to the nipple is shown in Fig. 1, which presents a sectional view of Peerless air brake hose and Westinghouse coupling, both with and without the nipple cap. In Fig. 2 is shown a nipple by itself, with and

place in the minds of railway people and of those whose systems have found lodgment on many of our railway lines. It is a mooted question with many of us whether a perfect system will ever be obtained.

Granting that a perfect mechanical device has been, or can be, invented, it then becomes a vexed question as to whether the hygienic conditions of the same can be adapted to the human family. A car just warm enough to suit one individual is too hot for his neighbor behind him, and too cold for the one ahead of him. The great and prevailing tendency, however, in car heating is superheating, and the average traveler is not satisfied with less than 70 degrees Fahrenheit in a railway car during cold weather. Many demand a much higher temperature, and few less than that.

Aside from supplying a uniform degree of heat, a more serious question confronts us: "Is such a practice conducive to the health of our people?" Who can say that it might not be better for us if the old car stove were rehabilitated, even if it is associated with apparent danger from fire? We might not feel so comfortable, but we would probably live longer and enjoy better health. These are days, however, of luxury, comfort and ease, and as public will comes very near being accepted law on railroads, its demands must be subserved. If one could do justice to the history of car heating, what interesting reading it would prove to be! Take the old-fashioned wood stove that demanded cordwood lengths to satisfy its craving appetite for fuel, what a boon it was in pioneer day of railways.

While admitting steam to be the accepted heating agent of today, many disagree as to the best method of applying and controlling it. The theory of a return system naturally suggests itself to the mechanical department as being the most rational and economical of all, because, if correctly worked out in detail, it can be operated with less steam, and because full benefit is gotten from the condensed steam. This means less coal and a saving to the company. With it there is no steam escaping under and around the coaches, and this has been particularly bad where hand-operated drip valves have been used, and has proven very injurious to the paint and structural work of cars.

There are objections that might be urged against a return system, some of which are as follows: It is very complicated, and requires the manipulation of a large number of valves and cocks. There is great liability that the condensation will freeze in a system of this kind, particularly in a long train where the condensation has to be returned to the locomotive and through steam couplings located under the car, because the condensation is under a partial vacuum, and, consequently, under low temperature. Another objection that might be urged, is the difficulty of regulating the steam in a train of cars. We all know that all cars in a train will not heat alike; this is due to the construction or condition of the cars themselves. If the doors and windows in all cars were fitted alike and the weather strips were alike, the presumption is that the rate of heating would be uniform; but as they are not, it

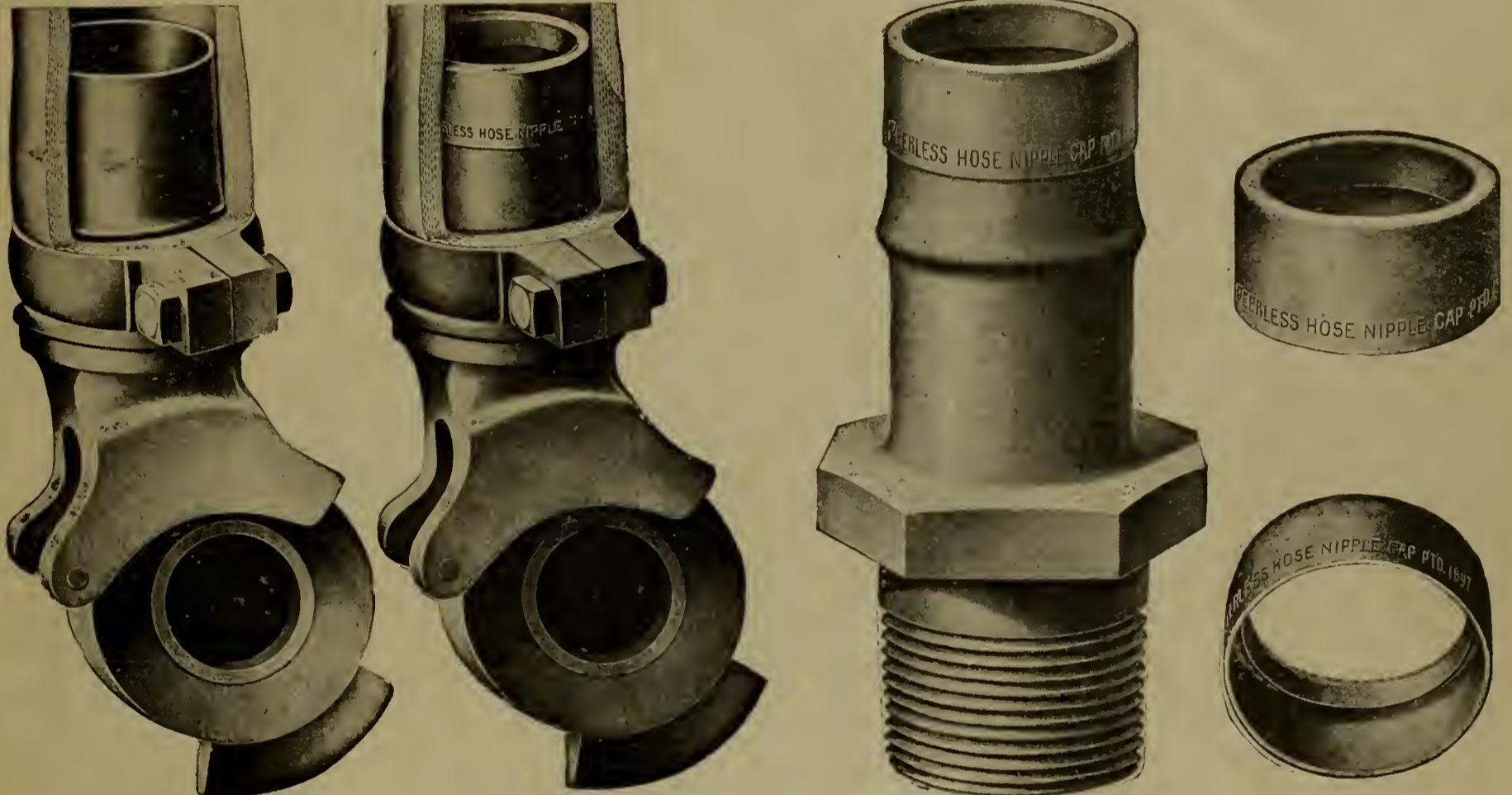

FIG. 1.

THE PEERLESS HOSE NIPPLE CAP.

FIG. 2.

without the cap, and in this figure is also shown two views of the cap. In putting the hose on it is necessary to coat the nipple with rubber cement to insure easy slipping on. Tests made with this device show that with a rubber capped nipple an advantage of from 45 to 55 per cent in wear of hose is gained over cases where the naked iron nipple is employed. The constant attrition between the harsh end of the iron nipple and the hose was what was ruining the latter, but the soft cushioning provided by the rubber cap removes this objectionable feature. The gain of 45 to 55 per cent in the life of the hose, which is claimed to be effected by the use of this simple device, is certainly worthy of consideration. These caps are sold by the gross, and at a very reasonable figure, considering the saving in the life of hose which they effect. It will readily be seen that the use of this cap in no wise tends to obstruct the flow of air. We are informed that the Peerless Rubber Manufacturing Company, 16 Warren street, New York City, has the sole license to manufacture these goods in the United States.

The old-timer was perfectly satisfied, because it was the best in existence. It kept the cars fairly comfortable and was undoubtedly more conducive to health, but it wouldn't keep our modern cars warm to-day, for it must be remembered that the cars of that day were small, stuffy affairs, with small openings and without raised decks; hence they were more easily heated.

Next came the coal stove, an innovation of decided improvement then, but despised later. What cheer and comfort it brought to the traveler in its day. But the coal stove was not alone in the march of progress; keeping step, yet ahead of it, was the car itself, growing larger, more luxurious and exacting, and the coal stove soon had to give up its crudity and accept the addition of down draft or heated air for the comfort of the pampered traveler. This was not good enough, either, and the supposed acme of car heating, "The Baker Heater," quickly supplanted it. One can almost imagine he still hears the echoes of "Eureka" shouted in its favor. It was many years before it began to lose favor, and it is a question with many to this day whether it was not, after all, the best heating device. Legislation was, no doubt, more instrumental in sounding its death knell than any or all theoretical objections to it.

follows that more steam will be required to maintain a uniform heat in a car with loosely fitted doors and windows than in a car with the same neatly fitted. Under the return system it seems the steam pressure must be uniform, as it is continuous throughout the train, running back on one side and returning on the other. It is impossible to cut off or apply steam to one part of the train without affecting the entire train; some car in the train would at times be either too hot or too cold on account of the above mentioned difference in condition of coaches. Whether this latter objection can be maintained I am unable to say.

The return system is not yet perfected, and it has not proven the success its projectors so fondly anticipated. It is understood that the condensation cannot be returned direct to the tank without expending more steam than is justifiable and perhaps overheating the cars. A vacuum pump has been mentioned in connection with the return system, but so far as has been learned there has not as yet been perfected any device of this kind that can be operated with economy and satisfaction. Notwithstanding these drawbacks, I think the return system is the rational one and should receive most consideration.

Next to the return system the storage system, which is virtually straight steam with either a double cylinder, the inner one containing a strong solution of salt water, or a single cylinder filled with sections of corrugated terra cotta, is probably to be desired. Should the steam fail, or the car be cut off, the radiation of heat from the hot water cylinder, or from the hot terra cotta, will insure a reasonable degree of heat for some time, and also allow a very uniform regulation of heat when the cars are in service. This system comes very near meeting all the requirements of practical car heating, and if the cars are properly piped and the piping provided with traps, there is no reason why good results should not be obtained.

State laws which prohibit the use of fire in railway cars for general heating purposes set the inventive genius to work, and the result is that steam, or a combination of steam and water, seems to be the accepted theory. Will the march of progress keep up its ceaseless, tireless tread and leave steam behind, finding in that greatest force of all, electricity, its successor as a heating agent? There are many today who firmly believe it is the coming heat, just as it has proven to be the light and power of today. Until it does come, however, we must content ourselves with steam and use steam as best we can

**HEATING PASSENGER CARS.\***

BY WM. GARSTANG.

The question of a perfect system of car heating, one that will meet all the necessary requirements without any objectionable features, is one that has occupied for years a

\* Abstract of a paper read at the November meeting of the Western Railway Club

There are a number of combination steam and water heaters, such as the commingler, the duplex coil and the steam jacket heaters. All these systems commend themselves, because of the fact that heat distributed in this indirect method is more regular and healthful than by the direct steam system, but objection to most of them is found on account of their complexity, or from their liability to become frozen, or because of the cracking or pounding noise made when steam is admitted. They are not so immediate in emergencies as direct steam, and there is always a chance of the water freezing in the Baker heater cross-overs, drums and jackets in extremely cold weather, and especially when these parts are located under the cars. This is not only annoying at all times, but is frequently expensive. Of course, it is claimed that if the car is given proper attention there is no danger of freezing. While this is true, there are times, nevertheless, when they do freeze, and this generally occurs when cars are cut out at such points as have no inspectors to care for them, or when they are not fitted with a perfectly automatic steam trap. So it appears that the combined steam and water heater requires more attention than can well be accorded at all times and under all conditions for the ordinary cars. Another objection is that in long trains the demand for steam is so great for hauling the train, and heating it as well, that the boiler cannot supply the high pressure demanded. In consequence, the rear cars are often uncomfortably cold. It is true a fire can be started in the Baker heater, which is used in connection with these systems, but these Baker heaters, when fired with anthracite coal, might make good refrigerators, because, some time after the fire was started, the train might run through a state in which fire is not allowed in stoves in cars, then this system under fire would not be available.

In a long train heated with steam and water, the demand on the boiler is too great, because it requires from 50 to 75 pounds of steam to successfully heat the train. This is exacting too much of a locomotive, perhaps already pushed to its maximum steam producing capacity, besides being very expensive in the way of wearing out steam hose. It is also dangerous, and makes it more difficult to regulate the temperature in such cars in the train as are equipped with straight steam. There are certain classes of cars in which it is desirable to use a system of this kind, sleeping cars, private cars, some parlor and dining cars. When steam and water are used, great care should be taken to use the system which will work equally well with either fire or steam, or with which steam and fire may be used together, without one destroying the efficiency of the other. Where steam is used in a system of this kind, it is very desirable that whatever heating is done should be done inside the car and at the base of the riser column, and whatever condensation is produced should be discharged from a point inside the car. This will avoid the possibility of water freezing in the pipes, and will prevent the cracking or pounding that is so annoying. As the condensation will vary greatly in a system using steam in connection with the Baker heater, it is quite necessary to use a first-class automatic steam trap which will discharge this varying condensation promptly and without personal manipulation.

The plain pipe, or direct steam system, seems to give the best satisfaction for the ordinary class of cars, because it is simplest in construction and manipulation, quickest in results, cheapest in first cost and most economical to maintain, at the same time meeting all the requirements when properly constructed and applied. When constructed so that each side can be operated independently of, or in conjunction with, the other, with proper drainage and automatic traps, it will undoubtedly prove satisfactory. It will give the requisite amount of heat in all kinds of weather while in service, and there is no danger of freezing when detached from train, either at terminals or intermediate stations. The trainmen readily understand its workings, as it is simple. It requires little attention, and is ready for service at a moment's notice. It will heat more rapidly than any other system in vogue, and a train of twelve or fifteen cars properly equipped with automatic traps can be heated with 20 to 25 pounds of steam.

A great deal of trouble experienced with steam heat in the past has been the result of imperfect construction or application of the details of the various systems. Aside from the actual heating service, the principal features of any system are as follows:

- The hose couplers between the cars.
- The control of the steam in the train pipe.
- The regulation of the supply of heat in the car.
- The method of disposing of condensation from the pipes inside the car, and from the train pipe and couplings.

It is a source of satisfaction to us that there are only two makes of steam hose couplers now in general use, and these two couplers are quite interchangeable; this simplifies the interchange of cars. One of these couplers is supplied with a small automatic drip valve at the lowest point, which is closed by the pressure of steam on the train pipe, and opens when the pressure ceases. This allows all condensation to escape and prevents freezing, and avoids the necessity of uncoupling the hose when the engines are changed, or whenever a train is to be without steam supply for any length of time. I have found this feature a very desirable one, particularly on long trains.

Until recently the control of the steam in the train pipe has been obtained by the use of some form of plug cocks located either near the center, or at the end of the train pipe, and a great deal of trouble and expense has resulted from the use of these cocks. It is a well known fact that

no form of plug cock is a desirable thing to use under steam or hot water. In the first place, a cock of this kind used under varying temperature, is certain to leak in a short time, owing to the strain resulting from the unequal expansion of the plug and shell of the cock. The result of a leaky cock in a train pipe is that the water escaping into the cold pipe, which is cut off, will freeze up and burst the pipe, and render the heating apparatus inoperative. For this reason I find that, instead of a cock, it is more desirable to use a single train pipe valve which will shut off the steam either way. This valve should be located near the center of the car, and can be operated from inside the car. A train pipe valve of this kind is particularly desirable on cars running at the rear of the train.

The disposition of condensation is probably the most important factor of any steam heating system. It is best to dispose of the condensation automatically, if possible. I say "if possible" because, until the last few years, quite as much trouble was experienced in trying to discharge condensation automatically as there was in discharging it by personal manipulation of valves and cocks. The recent improvement in steam heating devices makes it quite feasible to take care of the condensation automatically. It is very much more efficient and economical to do this automatically, and it will not allow of carrying a lower pressure and will permit a better regulation of heat in the cars.

It is a mistake to try to carry pipes full of condensation underneath a car, and to try to keep the water from freezing, and for this reason I have found it best to use an automatic trap which discharges condensation from an automatically operated valve, located at a point inside the car. I refer, of course, in this case, to the water which collects in the radiating or heating pipes inside the car. The principal objections to disposing of the condensation through a hand operated drip valve are that the valve has to be watched constantly to avoid waste of steam, or if the drip valve is shut too close, the water will collect at the drip and be frozen.

Water at a temperature above 180 degrees should not be discharged from the radiating pipes in a car; if it is, much heat which is available for heating is wasted.

Another point at which condensation will give trouble, unless disposed of automatically, is at the hose couplings, and for this reason the automatic relief valve in a coupling is desirable.

Still another point at which condensation will give trouble unless taken care of automatically is in the train pipe itself, particularly at the rear of the train.

Any train valve, or other device, placed on a train pipe under a car should be provided with a simple and automatic trap attachment for discharging at the rear of the train the condensation which collects in the train pipe. On some roads it is the practice to open up the rear train pipe cock and blow this condensation out before it becomes frozen, but the success of this method, of course, depends upon the memory of some train hand to prompt him to open the valve at the rear end of the train pipe, or to have the rear cock or valve open just wide enough to let the water out before it becomes frozen, and not wide enough to waste steam. There is, also, always the liability of the rear escape opening becoming clogged by scale or cinders or by pieces of the inside lining of the steam hose finding their way to the rear of train and lodging against the small opening, and causing a backing up of condensation in the pipe, in a place where the water may be quickly frozen.

In conclusion, I will say, no matter which of these systems you prefer to use, you must pay attention to the drainage and avoid locating beneath the cars those pipes which contain condensation. Avoid the use of plug cocks of all kinds, or you will not meet with any reasonable degree of success. In piping baggage, mail or express cars, do not place the piping immediately against the inside sheathing. If the piping is placed too near the sheathing the heat will probably blister the paint on the outside of the car, and the paint will soon drop off, especially when assisted by the sun in the spring. To guard against this, it is well to block the piping out an inch or two, leaving an air space between the piping and sheathing. It is still better to put a zinc shield between piping and sheathing, leaving an air space between each. The train crews should be educated to know just what degree of heat is preferable, and, to assist them, a thermometer should be permanently fixed in each car; then, if all the regulating valves are placed inside the car within easy reach of the brakeman or porter, there should be no reason why a proper temperature cannot be maintained in passenger cars, under all conditions and circumstances, with the direct steam system.

The Railway List Company announces that, beginning with the present month, the Official Railway List will be published monthly and the annual edition will be discontinued. As compared with the annual Official Railway List, the Monthly List contains several improvements:

1. A feature found in no other list of railway officers is the insertion (on colored paper, for convenience of reference) of several pages of news concerning recent changes, promotions, resignations, deaths, etc., and other items of interest to railway and railway supply men. These pages immediately precede the official lists of the roads.

2. In the finding list, names, official positions, and names of railroads are given with much less abbreviation than heretofore, thus rendering reference to the body of the List unnecessary.

3. The same plan is followed in the "Index to places in which there are railway general offices or shops," and this index also shows whether general or division shops are located in any place referred to.

The Monthly Official Railway List begins its existence with the prestige gained by the annual list during sixteen years of usefulness. This prestige, together with the advantages of fresh information and monthly corrections, will naturally, make it the accepted and standard publication of its kind in railway offices.

### THE HAMMETT OIL CUPS.

We illustrate this month a side and main rod oil cup and a guide oil cup that have met in practice with a very considerable degree of favor. The rod cup has a feed tube extended about two-thirds the height of the cup and a valve taking its seat in the top of this tube as shown. The reciprocating motion



ROD CUP.

of the rod lifts this valve until it strikes the adjustable feed screw shown, and thus determines the amount of the oil that will be fed for each stroke of the rod. There is a good strong hexagon formed on top of the main cup to screw the same firmly into the rod, and a threaded removable cap to provide for filling the cup. This cap carries a cross bar, which in turn carries the adjustable set screw for regulating the feed valve lift. The side and main rod cups have, as shown, a square-headed steel shank cast solid into them, which shank, or plug, is threaded to be screwed into the rod. As is well known, many of the ordinary best bronze cups are thrown off from their shank by the motion of the rods, and are lost. The use of the square-headed steel shank is claimed to have entirely overcome this trouble. It is true that a steel shank has been used before, but it has been screwed into the

bronze base and not cast in, and has, it is claimed, proven objectionable because of loosening. The reciprocating motion of the rod and the leaking of oil around the thread have caused this trouble.

The guide cup is made of the best bronze, and is strong and durable. It has a screw-adjusting oil valve feed as shown. In the head of the screw there is a bowed spring, the point of which is formed to lock into adjusting slots in the rim of the cup, thus providing definitely for any desired feed. There is a removable cap for filling and adjusting, and the cross bar inside of the cup is made heavy enough to be used to screw the cup in position on the guide.



GUIDE CUP.

Both of these cups, which are already in quite extensive use, have given very satisfactory results and are offered by M. C. Hammett, of Troy, N. Y.

### THE TIPPETT LUBRICATING DEVICE.

The question of getting oil to valves and cylinders with regularity of feed has been quite extensively discussed during the past year. There has in many cases been found difficulty in insuring a proper delivery of oil against the back pressure at the steam chest end of the tallow pipe. Among the devices which have been offered to overcome this difficulty is one that has met with a considerable measure of favor, known as the Tippett attachment, which was placed upon the market by the Detroit Lubricator Company. Our engraving shows the detail of this

attachment quite fully. It will be seen that it is very simple, and its efficiency is vouched for by many users. It consists simply of a pipe leading from the dry pipe back through the boiler head, to a connection with the two tallow pipes. As soon as the throttle is opened an extra current of steam is admitted into the tallow pipes, which effectually overcomes the back pressure and creates a circulation of steam within the pipes toward the cylinders. Thus as soon as the drop of oil rises through the sight feed glass it is carried at once to the wearing parts as intended. The reference letters and legends upon our plate clearly designate the parts of the entire apparatus and their relation to each other.

This device has been tested on several of our leading lines and always, we are assured, with the most satisfactory results. As an evidence of this favorable reception, we may add that on several roads on which tests of it were made, subsequent orders for new locomotives have in each case been accompanied by specifications for the Detroit lubricator with the Tippet attachment.

PERSONAL.

Mr. B. R. Hanson, master mechanic of the Texas Midland, was succeeded December 1 by U. R. Smitbime.

Mr. Alexander Shields, late master mechanic of the Chicago, Hammond & Western, has been appointed master mechanic of the Southern Indiana.

Mr. A. H. Maxwell, superintendent of the car foundries of the Pennsylvania lines at Altoona, died last week. Mr. Maxwell has held that position since 1853.

Mr. T. M. Downing, foreman of the Delaware shops of the Big Four road, has been appointed superintendent of motive power of the Columbus, Sandusky & Hocking Valley road, vice Mr. F. P. Boatman, resigned.

Mr. Harry W Frost who, for several years, has been connected with the business department of the Railway Age, has become the Chicago and Western representative of the Monarch Brake Beam Company of Detroit, Mich. Mr. Frost has been one of the best liked men among those connected with railway publications west and east. He has a wide, and exceptionally favorable, acquaintance among railway and railway supply men and cannot be otherwise than successful in his new field.

Mr. Gustave Jacques Maillefert, one of the oldest and most widely known employees of the mechanical department of the New York, New Haven & Hartford Railroad Company, whose strikingly picturesque likeness is given herewith, died at New Haven on December 9th. Mr. Maillefert was born at Royamont, France, Feb. 3, 1823. He was educated in the technical schools of Paris, and afterward served an apprenticeship in a machine shop in that city. He came to the United States in 1851 to assist his brother, who was at that time engaged by the government in an attempt to blast a channel through Hell Gate. In 1853 Mr. Maillefert entered the service of the New Haven



road at their New Haven Shops. He afterward served in various capacities at the shops, but for the past 15 years was located in the draughting room. He was a member of the American Society of Mechanical Engineers, having joined that organization in 1887. Mr. Maillefert was highly respected by all who knew him, and his death is greatly regretted by his many friends.

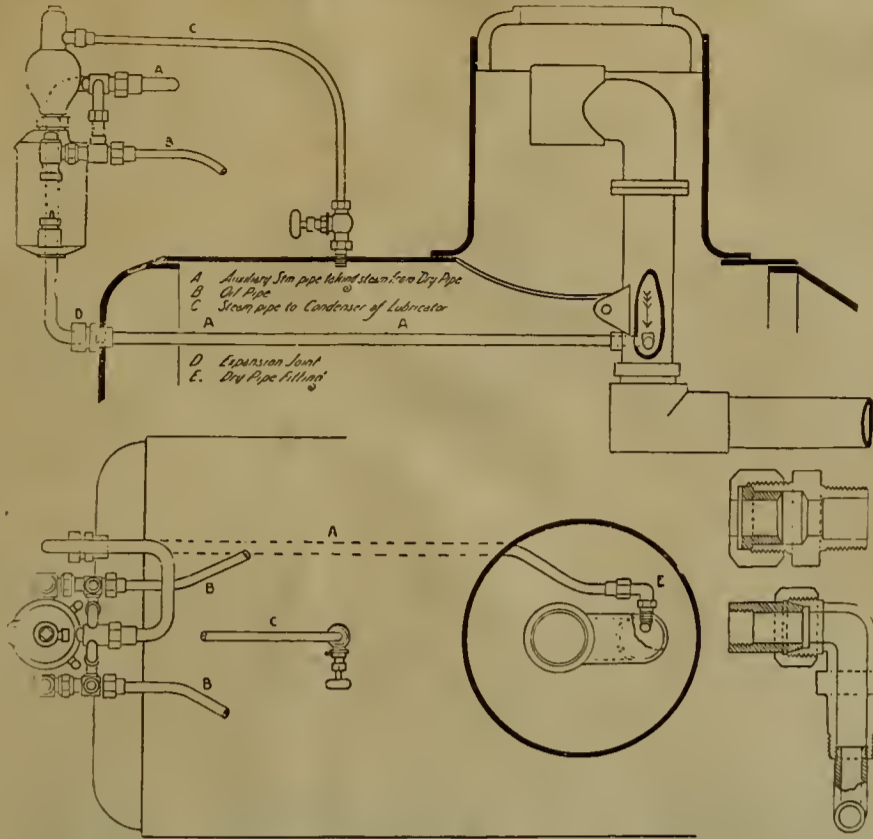

THE TIPPETT LUBRICATING DEVICE.

It is reported that Mr. E. W. Grieves, who recently resigned the important post of superintendent of the car department of the Baltimore & Ohio, has accepted a connection with the Galena Oil Works.

On the Southern Railway an interesting change in staff has been made. Mr. W. H. Peddle has been appointed "general superintendant of maintenance," and is placed "in charge of all matters pertaining to the maintenance of shops, machinery, motive power, cars, tracks, bridges and buildings." Under this arrangement the superintendent of motive power reports to the general superintendent of maintenance.

Mr. W. C. Ford has succeeded Mr. John A. Chater as business manager of the Railroad Car Journal. Mr. Ford has a host of friends east and west, made during his long connection with the Railway Age, who will wish him well in his new venture. Mr. Ford and Mr. Phillips, the editor of the Car Journal, will make a strong team and will no doubt maintain and even raise the high standard which the Car Journal has attained. We are not informed as to the future movements of Mr. Chater.

Mr. T. A. Lawes, superintendent of motive power of the Chicago & Eastern Illinois Railroad, is an amateur astronomer, and enthusiastic over the study. He has just received from the celebrated firm of Alvin Clark & Sons, Worcester, Mass., a new telescope with 6 1/2 in. lens and tubes 8 ft. 4 in. long. He has just completed at his home at Danville, Ill., a small observatory, which has many of the conveniences of larger ones. It is so built that it can be taken to pieces and removed to another location at small expense. Mr. Lawes has had two smaller telescopes before, and anticipates pleasure and profit in the use of the larger and better one.— [Railway and Engineering Review.]

SUPPLY TRADE NOTES.

—Mr. W. S. Calboun has left the Brussels Tapestry Co. to accept the general eastern agency of the American Steel Foundry Co. Mr. Calboun is an energetic, pushing, sales agent and his new connection should prove mutually advantageous.

—The Williams & Moore Manufacturing Co., of Chicago, lately assigned, have sold out their entire interests to the Q & C Company, of Chicago. The rail jack, known as the Williams & Moore, will hereafter be manufactured by the Q & C Company, as will also the Williams drill.

—The Jones & Lamson Company, Springfield, Vt., reports to a contemporary railroad paper that the demand from railroads for turret lathes, which was small during the first half of 1897, has been, during the last half of the year, equal to that of the first six months of 1893 and promises to attain very large proportions during 1898. The fact is that each turret lathe of this company acts as a soliciting agent for the sale of its fellows and is generally successful in this role.

—The Schenectady Locomotive Works are well filled up with contracts, among them being a large order. A number of departments are running 24 hours per day. The company shipped 22 locomotives to Japan during 1897.

—The Sargent Company, Chicago, has a steadily increasing business in both steel castings and brake shoes. The business of the company is now very large and promises to break all records during the present year.

—A. G. Richardson, general sales agent of the Ewald Iron company, of St. Louis, has resigned. Mr. Richardson

had been with the Ewald company for eight years and had become so identified with its interests that his going away comes as something of a surprise. Mr. Richardson expects to engage in other business.

—The National Electric Car Lighting Company, New York, seems to be well on the way to a large success and the only success attained in the field of electric car lighting by power obtained from the axle. A large number of cars equipped by this company are now running on the Atchison, Topeka & Santa Fe road and the service has been so uniformly satisfactory that a number of other roads in this country and Canada are negotiating to have the system applied to their cars.

—The Shaw Crane Co., at Muskegon Heights, Mich., reports having enjoyed a gratifying business in 1897, and states that the railroad companies in need of crane equipment are daily pursuing their inquiries in that line.

—Of Dixon's American graphite pencils, the company which manufactures them (the Joseph Dixon Crucible Co.) says: "These pencils represent American materials, American capital, American brains, American labor and American machinery." Such a combination ought to produce pencils of the very highest class—and it does.

—As a sample of the governmental policy which prevailed in Cuba at the outbreak of the present war, and which Spain is trying to establish and maintain, the following fact is suggestive: Only a few months before the outbreak of the revolution an order of ten cars were shipped to Havana from this country. The value of the cars was \$5,000, and the impost duties, fees, etc., which the consignees were compelled to pay before they could get possession of the cars at Havana amounted to \$7,000, making the total cost \$12,000.

—The Q & C Co. has just made arrangements with the National Railway Specialty Co. to manufacture and license their rear edge protection strip, which will be called the "N. R. S. Protection Strip," and which can be used with the Q & C Co.'s doors.

—Mr. P. M. Serdobin of St. Petersburg, Russia, is in this country looking after machinery matters. He represents in Russia the Garvin Machine Co., J. A. Roebling's Sons Co. and the Fifield Tool Co.

—The Lunkenheimer Co., Cincinnati, New York and London, England, has been making preparations for a large shipment of valves and machine fittings to South Africa that will aggregate 26,000 pounds. A consignment has just been made of 4,000 pounds of brass fittings to Sweden by the company.

—Mr. Chas. F. Pierce, who recently severed his connection with the Sterlingworth Railway Supply Co., has accepted a connection with the Monarch Brake Beam Co. of Detroit, Mich. Mr. Pierce will have charge of the eastern field, and will have his office at 1203 Havemeyer Bldg., New York.

—Mr. A. M. Castle, No. 9 South Canal street, Chicago, Ill., has been appointed western sales agent of the Oval Brake Beam Co., and will be pleased to give any information desired relative to the merits of the beam which he is handling.

—The Missouri Malleable Iron Co. is preparing plans for the enlargement of its plant in East St. Louis, and will spend \$200,000 for the purpose. The present shops are very extensive and complete, as was shown by our illustrations and description that we gave of them in our issue of February, 1897, but increasing business demands enlarged facilities.

—The Carey Asbestos Co., at Lockland, O., is making a specialty of its new patent roofing. This article is fully up to the standard of this company's other brands, and is meeting with deserved success.

—That the outlook for car building during 1898 is favorable is proven by the statement of the Ensign Manufacturing Co., of Huntington, W. Va., who report that inquiries are more numerous and favorable than at any time during the past five years.

—The Chicago rabbeted grain door and security lock brackets were specified on the following box cars recently let, viz.: 250 Illinois Central, to be built by St. Charles Car Co.; 1,000 Illinois Central, to be built by Haskel & Barker Car Co.; 250 Illinois Central, to be built by Missouri Car & Foundry Co.; 350 Detroit, Grand Rapids & Western, to be built by Michigan-Peninsular Car Co.

—The Westinghouse Electric & Manufacturing Co. has installed, in its works at East Pittsburg, a 250 horse power Westinghouse gas engine for the operation of the railway generator to be used in connection with the company's experiments on the Turtle Creek branch of the Pennsylvania Railroad.

**SITUATION WANTED**—A CAR DESIGNER AND BUILDER wants to make a change. Is a technological graduate and has had 20 years practical experience in designing and making cars and parts of cars; is a first-class draftsman. Has a wide acquaintance among American railway mechanical officials and car manufacturing concerns; and also a wide experience with mechanical railway officials in England, Australia, Austria, Germany, France and Sweden. Can undertake to introduce car designs and car appliances in all foreign countries. References of the highest class. Address: CAR DESIGNER, care Railway Master Mechanic.

**WANTED**—A GRADUATE OF THE BERLIN POLYTECHNIC Institute who has practiced some years as consulting engineer desires a position in a railway drafting room. Address "R" in care of this paper.

NEWSPAPER ADVERTISING IN THE UNITED STATES. A book of two hundred pages, containing a catalogue of about six hundred newspapers, being all that are credited by the American Newspaper Directory (December edition for 1897) with having regular issues of 1,000 copies or more. Also separate State maps of each and every State of the American Union, naming those towns only in which there are issued newspapers having more than 1,000 circulation. This book, (issued December 15, 1897) will be sent, postage paid, to any address, on receipt of one dollar. Address The Geo. P. Rowell Advertising Co., 10 Spruce St., New York.

ILLINOIS  CENTRAL

**CHICAGO**  
TO  
**ST. LOUIS**

*THE DIAMOND SPECIAL*

**SOLID VESTIBULE TRAIN.**  
Daily at 9.00 p. m. from Chicago. New and elegant equipment, built expressly for this service. Train lighted throughout by gas. Tickets and further information of your local ticket agent, or by addressing A. H. HANSON, G. P. A., Ill. Cent. R. R. Chicago, Ill.

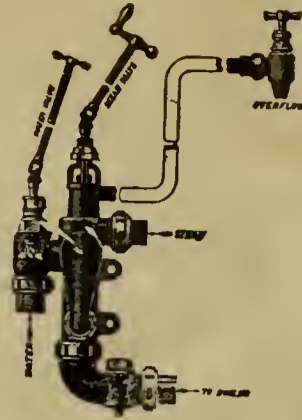

THE  
**NEW "NATHAN"** (See Illustrat'n)  
AND  
**MONITOR INJECTORS**  
FOR LOCOMOTIVES.

"Nathan" Sight-Feed Lubricators  
For Cylinders and Air Brakes.  
**STEAM FIRE EXTINGUISHERS**  
for Switching and Yard Engines.  
**BOILER WASHERS, BOILER TESTERS,**  
**ROD AND GUIDE OIL CUPS, ETC.**

**NATHAN MANUFACTURING CO.,**  
92 and 94 Liberty St., NEW YORK. 147 & 149 Van Buren st. CHICAGO.

Keep Your Cars Off of Their Side Bearings ===== Prevent Flange Wear of  
Wheels ===== Lessen the Number of Derailments ===== Save the Great  
Expense of Unnecessary Dead Weight by Using

# THE BETTENDORF I BEAM BOLSTER

Made to suit the standard trucks of any road or car company.



WEIGHT:

Truck Bolster / / / 450 pounds.  
Body Bolster / / / 350 pounds.

Saving from 500 to 1,500 pounds per car over other forms of construction.

STRENGTH:

Send for report of tests made by Robt. W. Hunt & Co., showing unequalled carrying capacity.

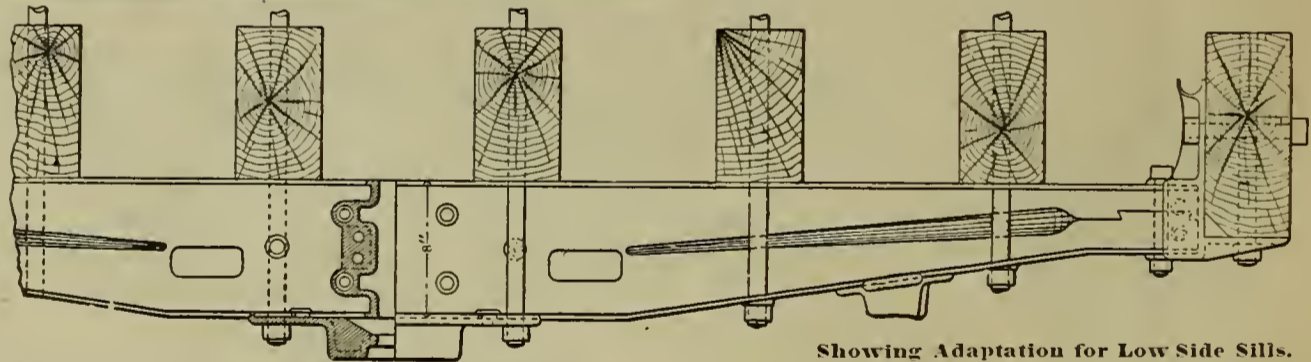

Showing Adaptation for Low Side Sills.

THE CLOUD STEEL TRUCK CO., 1425 Old Colony Bldg., CHICAGO.

# THE GRAVITY CAR COUPLER.

AN ABSOLUTELY AUTOMATIC COUPLER.

Cuts the Cost of the Vertical Plane Type in Two.

THIS COUPLER takes the ordinary Link. The latch cannot  
Is always ready to couple. jump up, or creep  
Works on heaviest curves. up, and release link  
Gives a center draft. by motion of the  
Is compact, light and strong. cars.

IT HAS STOOD THE SEVEREST SERVICE TESTS IN MOUNTAIN AND YARD SERVICE FOR MONTHS. WEIGHT, COMPLETE, 145 LBS.

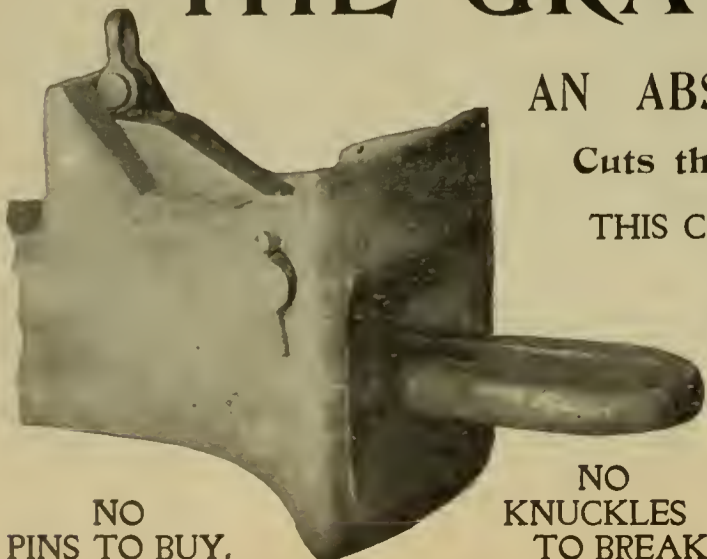

NO PINS TO BUY. NO KNUCKLES TO BREAK.

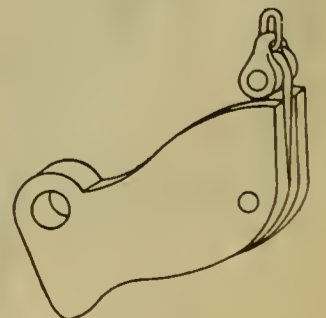

The Latch.

For details address **The Gravity Car Coupling Co.,** Colorado Springs, Col.

# RAILWAY MASTER MECHANIC

WALTER D. CROSMAN, Editor.

EDWIN N. LEWIS, Manager.

PUBLISHED MONTHLY BY

THE RAILWAY LIST COMPANY

Devoted to the interests of railway motive power, car equipment, shops, machinery and supplies. Communications on any topics suitable to these columns are solicited.

Subscription price, \$1.00 a year, to foreign countries \$1.50 free of postage. Advertising rates given on application to the office, by mail or in person. Address

THE RAILWAY LIST COMPANY,

The Rookery, Chicago, Ill.

The Official Railway List is published by this company.

VOL. XXI. CHICAGO, FEBRUARY, 1898. No. 2.

The strike of the mechanical labor unions in Great Britain, to which we made editorial reference last month, has terminated and work was resumed in most shops on Monday, January 31st. The labor unions were utterly defeated and the employers will now be able to manage their own shops without interference. The victory seems to have been entirely on the side of the employers, who can now manage their own shops to an extent which, heretofore, was impossible. That the British workman will soon realize that his present defeat has been a real advantage to him, we fully believe.

It is not new that locomotive steam gages read incorrectly, but it is true that the fact is often lost sight of, or at least passed over with inadequate attention. Some suggestive points are made elsewhere in this issue in an article on this topic, which it may be well for at least the younger generation of our readers to study. There is an unquestioned fact that gages vary in the readings they give, according to their temperatures. Our contributor gives no data as to the exact variation between cool and heated steam gages. Of course this would vary with different constructions of gages, and any data to be of exact value would necessarily have to be limited to one certain make of gage and the name thereof given. We may say that one of our prominent Chicago roads has been obliged to take up this matter recently, and that some of the gage makers are trying to overcome this heating feature.

A particularly lucid and satisfactory explanation of the construction and operation of the injector is that which was recently presented by Mr. Bischoff before the Locomotive Foreman's Club of Chicago, and we give it practically in full in another column of this issue. The theory of the injector, in all of its refinements, would take volumes (in fact it has done so) for its thorough exposition; but in the present paper there is grouped in concise form all that is essential to a fair understanding of its working, and this is followed by some practical suggestions as to why they sometimes fail to work, and as to the cure and prevention of the ailments with which this very useful piece of mechanism is assailed. The paper is worthy of being very widely read, and this young and promising association—the Locomotive Foreman's Club of Chicago—is to be congratulated upon producing such excellent literature.

The banquet given the evening of January 27, at the Waldorf-Astoria hotel, by the business men of New York, to the delegates to the third annual convention of the National Association of Manufacturers and their invited guests is said to have been the largest, with one exception, ever given in that city. Over one thousand people sat down to it, and among the guests was the President of the United States. It is becoming more and more evident that President McKinley comprehends the industrial interests of this country and understands their importance to a degree which sets him apart from and above the most of the presidents who have preceded him. He is far more than a politician; he is an honest, earnest, able and practical man who realizes that the welfare and progress of this nation depend upon its industrial prosperity. In spite of what partisan newspapers and politicians may say, no fair-minded

man doubts his sincerity. He is, pre-eminently, the business man's and the working man's president, and there are good reasons for believing that under his administration the United States of America will enter upon a period of unparalleled industrial development. It is certain that to the fullest extent of his knowledge and ability he will so administer his great office as to help and not to hinder this development.

The British mechanical labor unions have for many years limited the output of machinery to from 25 to 60 per cent of its capacity. The reason given for doing this has been that such a policy gave employment to many more men than could have been supplied with work if every machine had been worked to its full capacity. It is the same argument which has been used in opposition to the introduction of machinery from the beginning. It has a benevolent and unselfish sound, this argument, but it is a misleading and injurious one. The doctrine that one man should hold himself back in his work and produce less every day than his strength and skill would naturally produce if he worked simply for himself and for those dependent on him in order that another man may get employment is a demoralizing one in its actual results. There is no genuine philanthropy in it and it tends to make all workmen less efficient. The only way in which the highest degree of manhood in character and efficiency in workmanship can be attained, is by encouraging and making it an object for every man to do the best he can. The country in which every workman does his best every day and every hour will not have to worry about its unemployed class, for it will not have one. Its constantly growing industries will provide work for all; while under the other policy the proportion of the unemployed steadily increases.

The growth in number, strength and importance of railroad clubs and associations has been a marked feature in the progress made by the railroads of the country during the past fifteen years. This is especially true in connection with the mechanical and operating departments. The interchange of ideas and experience, which was the theory upon which these organizations were projected, has resulted in making common cause of all the problems attending these branches of railroading, and (in many cases) in arriving at satisfactory solutions of them. It is not too much to say that the science of railroading, so far as it has been developed in the departments in question, owes its present standing almost entirely to this source. It is, therefore, with some surprise that a tendency is observed in some quarters to withhold information concerning further advances in these lines, and that some roads "do not propose to experiment for the benefit of competitors," preferring to keep their "own information for their own use," and not seeing "why other roads should profit at their expense." Were the information thus sought to be withheld of a character that would make its publication of less value to any one, there might be some excuse for this reluctance to share it with others; but such improvements are commonly in the direction of economies, and therefore possess no such quality. Improved methods of getting business might come in that category, but improved methods of handling business do not. In fact, the financial safety of each railroad depends, in a large measure, upon the prosperity of its competitors, and it is only contributing to its own welfare when it is helping its neighbor without detriment to itself. To say nothing of the moral equities involved, a railroad is therefore best promoting its own interests when it is sharing its knowledge of increased economies with others.

The mechanical officers of railways are quite prone to adapt for their own use ideas which are original with others. The same is true of supply men, but that is another matter, and the first statement is made only to give an opportunity to add a cautionary explanation to those who are apt to make "Chinese imitations" of devices without questioning whether such imitations, or even the modified devices, are suitable for their own use. It is not always desirable to take, without modification, ideas for the design of parts, or the arrangement of parts, of cars or locomotives from manufacturers; not because the manufacturer is not capable, nor, again, because he would wilfully make a bad design, but because the idea which guides the manu-

facturer is to so design the parts that they may be made and assembled for the least cost. The question which confronts the user, the railroad official, is the cost to manufacture, it is true; but, besides that, he should consider the cost, the ease of repair. Frequently a very unmechanical, even an ugly, design has been made necessary to facilitate repairs; whereas, were it a question only of erecting during manufacture, a very neat and mechanical design might have been used at even less cost. The same may be said of methods of operation; a manufacturing shop may be equipped in a manner, and the operations on the different tools may be done in such a way, as to impress the railroad man very favorably, but he must consider well before putting the same tools or the same practices in use in the shops under his supervision. Perhaps the entire idea may be well expressed by the Irish "bull:" "The thing may make all right, but, to repair it, it would be necessary to throw it away and build a new one."

A very attractive arrangement for taper bolts, used in side rods and in other parts of a locomotive, where it is necessary to loosen the bolts frequently, or to remove them entirely, is to put a thread on both ends of the bolt. A taper bolt which has a solid head at one end will not fit tightly in the hole after the bolt has been removed once or twice; when the nut is tightened the strain will be received by the head, and the bolt will not fit snugly in the hole. If the bolt is threaded at both ends, there being a nut in place of the usual head, the nut so used can be eased off a trifle after each removal of the bolt, if necessary, and the bolt changed in its position just sufficient to allow it to fit tightly in the hole. By this arrangement the bolt may gradually adjust itself to even a better fit than it had the first time put in. If a fixed head is used on a taper bolt the bolt may be let into a bearing by reducing the head, but such adjustment can not be so nicely nor so quickly made as can the adjustment with the nut. On the other hand, this ease of adjustment of the bolt threaded at both ends is its weak point. It is too apt to be the case that the nut at the larger end of the bolt will be eased off too far, the other nut tightened, and the bolt drawn to fit snugly; then when the other nut is found loose it will be tightened and the bolt be drawn from its place. When a taper bolt, threaded at both ends, is used, every one who is in any way responsible for its adjustment should be thoroughly impressed with the fact that the nut at the large end of the bolt must be properly adjusted first and the bolt drawn to a fit in the hole, and that this nut must fit tightly on the parts clamped together when the nut at the other end is drawn up.

The passing of the title of Master Car Builder is considered at some length in another column of this issue by a correspondent who is evidently quite earnest. But it is futile to attempt to stem the tide of thought and action on this point. The tendency to consolidate the two departments of cars and of machinery is entirely too strong. It is undoubtedly a matter of economy if the chief of the mechanical department is competent and broad-minded and has the ability to surround himself with able assistants, to have the car and machinery departments consolidated. This procedure insures not only direct economy but uniformity in practice—which also means economy. As to whether the car department man should be at the head of the consolidation, or the locomotive department man, should be decided by the comparative ability of the two men and their qualifications. On a large road the executive officer of the department need not necessarily be an expert in all the details of his department, in order to handle it economically and successfully. Good executive ability and the ability to select competent helpers is of more importance than a knowledge of the detail of the shop work. It is a common experience to find that foremen, or others in charge of men, who were expert workmen, as a rule made a failure in handling large numbers of men in the shops. Possibly that would not be found universally true, but there is a principle involved which makes it wise, in selecting executive heads for departments, to select those who have ability to wisely handle and direct men, rather than ability to do expert work with their own hands. At the present time railroads are appreciating the value of men with technical education, and young men with technical training are being given preference in official posi-

tions, especially in the mechanical department. It is a fact that such young men generally choose the locomotive branch of work, one perhaps partially to the fact that none of our technical schools as far as we know, give any attention to car construction, pure and simple, in their courses. As this condition of things exists, only a few men with technical training have positions in charge of car department work, and many technical men have positions in charge of locomotive department work; so, when consolidation takes place, the locomotive man is by right of superior preparation bound to be given the preference in being put in charge of the department. As to whether the man in charge of the car department work shall take the title of Assistant Superintendent of Motive Power or Master Car Builder, it really makes little difference. On a large road either of these titles would seem to be appropriate. On a small road with one shop, it would seem that the title of General Foreman of the Car Department was an appropriate and proper title. Where departments are consolidated, the English style of title of Mechanical Superintendent fully embraces the position, and indicates to an outsider the character of the office held. The title of Master Car Builder to an outsider does not convey anything more than the title of Master Carpenter or Master Mason, that is, a man who is in charge of a small gang of men by virtue of his being an expert workman.

#### SOME POINTS ABOUT PISTON VALVES.

There are given in another column of the present issue engravings which show the cylinders and valves for the 12-wheel locomotives built recently by the Brooks Locomotive Works for the Great Northern Railway, and which were quite fully illustrated in our last issue. The locomotive as a whole is remarkable, but the cylinders have attracted especial attention and they are presented now for more detailed mention. The diameter of the cylinder, 21 inches, is not extraordinary, but the length of stroke, 34 inches, is remarkable. Another feature which has attracted attention, is the use of piston valves to distribute the steam to the cylinders.

There are many piston valves in use on locomotives but there can be no doubt that the use of piston valves in these locomotives will be considered a decisive step, and the action and the service of the valves will be closely followed. Considerable experience has been had with piston valves and it is very probable that the designers of the one under consideration have profited by such experience; at least some of the objections which were at first urged against piston valves have been overcome, apparently, in this one.

One of the strong objections to the piston valve, and one which has not been entirely surmounted in any design with which we have been familiar, is the great amount of clearance represented in the length of steam passage between the cylinder and the valve. The percentage of clearance represented by this length of passage probably decreases with the length of cylinder, and we are informed by the builders of the Great Northern engine that the percentage has been considerably reduced in the present design. It is considered good practice to use spring rings with but little adjustment, and to renew them when the wear is of sufficient amount to be objectionable. The piston valve is certainly better balanced than the D valve, but as the length of the cylinder is increased the length of the valve must also increase correspondingly and the weight of the valve becomes sufficient to cause considerable wear, even though the steam pressure may be entirely balanced. With the better balanced piston valve it should be possible to use lighter valve motions than those that are now stiff enough for the D valve, and the springing of such parts, when not stiff enough for the D valve, will be much less with the piston valve.

One of the first difficulties experienced with the piston valve was that, although the ends of the valve were considered as the controlling edges, in reality the edges of the spring rings, which were used to make the joint between the valve and its cylinder walls and which were placed back from the ends of the valve, were the controlling edges and the steam was wire-drawn, to an objectionable degree, around that part of the valve which projected beyond the packing rings. It will be noticed that in the present design the outer edges of the rings form the outer edges of the valves; the same is true of the

inner edges but the inner edges do not give an opening as free from obstruction. There will be many questions asked about these valves and their performance.

#### COMPARATIVE TRACTIVE POWER OF SOME HEAVY LOCOMOTIVES.

The heavy Brooks engine for the Great Northern road, which was illustrated in our last issue, has commanded an unusual amount of interested attention at the hands of students of locomotive design. We give elsewhere in this issue some comment upon its cylinders and piston valves. We have further thought that it would be of interest to inquire somewhat into the effect upon the power of the engine of its extremely long piston stroke (34 inches), its high boiler pressure (210 lbs.) and its driving wheel diameter (55 inches), which is large for this size of engine. In going into this matter we take occasion to compare the tractive force per pound of average steam pressure of the Great Northern locomotive with the same force for locomotives with which this one can be compared. The following data and results of calculation are given to facilitate this:

	Great Northern.	Mexican Central.	St Clair Tunnel.	Burlington and Missouri Riv.
Diameter of Cylinder	21 in.	21 in.	22 in.	22 in.
Stroke of Piston	34 in.	26 in.	28 in.	28 in.
Boiler Pressure	210 lbs.	180 lbs.	160 lbs.	160 lbs.
Diameter of Drivers	55 in.	49 in.	50 in.	50 in.
Weight on Drivers	172,000 lbs.	145,000 lbs.	180,000 lbs.	150,200 lbs.
Tractive Power (calculated)	48,600 lbs.	35,800 lbs.	36,700 lbs.	36,700 lbs.
Coefficient of Adhesion (calculated)	1	1	1	1
	3.53	4.05	4.9	4.09

The tractive power is calculated by the formula which was recommended by the Master Mechanics' Association. In this formula the tractive power varies directly as the stroke of piston and directly as the boiler pressure, but indirectly as the diameter of the driving wheels. It was probably considered necessary to use the 55-inch wheel and therefore, to get the required tractive force it was necessary to increase the other factors which affect directly the available tractive power. The boiler pressure and the length of stroke were selected for such increase, evidently, and these were increased to quite unusual proportions; the length of stroke should increase proportionally with the increase of boiler pressure in order to obtain full advantage of expansion. The table above would indicate that it is a question whether the boiler pressure and length of stroke were carried to unnecessary extremes; it would appear likely that the locomotives may prove to be a little "slippery," in other words "overcylindered;" the calculated coefficient of adhesion for the Great Northern locomotive is 1-3.53; for the Mexican Central and the Burlington & Missouri River locomotives the coefficients are practically the same, being 1-4.05 and 1-4.09 respectively; while for the St. Clair Tunnel locomotive the coefficient is practically 1-5. The recommended practice is 1-4.25 for locomotives for freight service.

Assuming a coefficient of 1-4.25 then the tractive power for the Great Northern locomotive should be about 40,470 lbs. and this power might have been obtained with about the following combinations of conditions:

Diameter of cylinder	21 in.	21 in.	21 in.
Stroke of piston	28½ in.	30 in.	27 in.
Boiler pressure	210 lbs.	200 lbs.	200 lbs.
Diameter of drivers	55 in.	55½ in.	50 in.

The last column in this table brings the locomotive within the comprehension of the average railroad man and although the machine is a large one its capacity for hauling is quite within our range of vision when we are guided by the last column. We desire to make it as emphatic as possible that this is not a criticism of the design of the Great Northern locomotive; we know nothing of the conditions which dictated the proportions used, but whenever unusually high limits are used for locomotive parts the mind is apt to center on the extremes and to fail to make due allowance for other data which affect the results to be expected. It is the object of this reference to the power of the machine, to show what influence the diameter of driving wheel, boiler pressure and the cylinder proportions have on the hauling capacity of the locomotive and, while making due allowance for the proportion of each part, to lessen the effect which the extreme dimensions may have upon the average mind and to show how

the locomotive really compares with others with which it is fair to compare it.

#### THE WORK AHEAD FOR THE MASTER MECHANICS.

While the calendar year is just commencing, the year of the Master Mechanics' Association's annual work is, or should be, nearly half over. It is now only about six months before final action must be taken on the various propositions that will come before the association; but beyond this there are many topics which are underlined for study, upon which no action need necessarily be taken, but upon which intelligent discussion will be of great value to all members of the association. We propose to touch briefly upon some of these topics.

Tonnage rating for locomotives is making rapid progress and many roads have already adopted it. The engineers and firemen do not appear to look upon it kindly in some places, however, and their cooperation is certainly necessary for its successful working. On the Cincinnati, Hamilton & Dayton and other roads about Cincinnati, they look upon it as a cause for grievance and have already threatened to strike if the tonnage rating is continued. On the Central Railroad of New Jersey, General Superintendent J. H. Ollhansen has offered a premium of over \$100 each month to the engineer and fireman who haul a tonnage in excess of the rated capacity of the engine.

Mr. Henderson, the chairman of the committee on this subject, has already placed in convenient shape most of the theoretical data necessary for calculating the tractive power of locomotives, and it may be found in the report on grate and heating area, and cylinder volume, in the 1897 Proceedings of the Master Mechanics' Association. It is a more difficult matter, however, and one to which theory cannot be closely applied, to determine the resistance of freight trains under the many conditions which affect train resistance. The resistance of empty cars per ton is often more than double that of loaded cars. Coal and stock cars have a different resistance from box cars. The resistance per ton increases with the length of the train and with speed. It is difficult to see how any very exact rule can be made to have general application to such various conditions; and yet it is necessary to take some account of them, in order to assign to an engine a tonnage which shall have in its resistance some definite relation to the tractive power of the engine.

If a schedule is made and stops so arranged that a train in descending a grade can continue on with the velocity and momentum thus attained, to assist in ascending the next grade, the engine can be given a much greater tonnage than when these advantages are lost or are not available. This is another variable which renders tonnage rating a very uncertain quantity; and although many superintendents profess to be working their freight traffic on the tonnage basis, yet we do not believe that the majority of them have yet awakened to a realization of its first principles. We hope Mr. Henderson's committee will succeed in making the way plain.

The advantages of improved machine tools for railway shops is a live topic, made more interesting by renewed prosperity, and the possibility of purchase. This subject was included in a paper on the efficiency of machine tools, presented at the April, 1897, meeting of the Western Railway Club; and the Central Railway Club had a paper on the same subject at its January meeting. Considering the increased speed and strength of modern tools, resulting in most cases in at least double the output of finished material, it is surprising that so many antiquated tools still remain in railway shops. More of them are to be found there than in any other shops of equal size and importance. It is certainly not because the foremen and master mechanics do not know and appreciate the advantages of modern tools; but it is, in many cases, because they do not know, in detail, what their work is costing, and what it ought to cost. The introduction of piece-work in railway shops is rapidly changing this condition of affairs, and a comparison of prices between shops having old tools, with those newly equipped, soon reveals the inefficiency of the old tools, and it is then easily possible to present to the management such good reasons for the purchase of the new tools, that they will be forthcoming. One argument against the purchase of new tools is the fact that their output is so great that they soon run out of work and are allowed to remain idle. But this can, in many cases, be met by the concentra-

tion of work on standard details at the principal shop when new tools are installed; and the old tools at other shops can then remain idle or be used on light repair work, when speed and heavy cuts are not so important.

Locomotive cylinder fastenings is a subject which, if properly treated, should be fully illustrated. One of the best pieces of railroad club work ever performed is the report on this subject, which may be found in the proceedings of the Southern and Southwestern Railway Club of November, 1893. This report covers fifteen pages and is illustrated by numerous first-class drawings. It is so complete a treatise on the subject, so far as simple locomotive frames and cylinders are concerned, that the present committee will have to draw on it largely for its material, or unconsciously duplicate it. We do not see how they can improve on it, except to describe forms of fastenings made necessary by recent large locomotives. The large cylinders, with diameter as great as thirty-four inches, now used on two cylinder compound locomotives, call for new and original designs for fastening them to the frame. They extend in so far that bolts have to be driven through the cylinder walls, and the saddles are so high that top and bottom frames are spread very wide apart. As Mr. Sague, the chairman of the committee on this topic, has had much direct experience in this work, we anticipate that the principal part of his report may relate to cylinder fastenings for compound engines. On account of the large amount of labor necessary to forge and finish the frames for the large locomotives now building, cast steel frames offer an attractive substitute for the forged ones. They can be made to within about one-eighth inch of finished sizes, and thus require rather light work on machine tools. All danger of welds failing is removed, and the strength of the material can be made thirty or forty per cent greater than hammered iron. With the introduction of steel frames, the design for fastenings may be improved, as the material can be made in the most desirable shape and, with greater strength, larger bolts can be used.

Insulators for boilers and cylinders, is a subject which should have been included in the report on locomotive jackets, last year. The amount of time taken to show that common iron, or cold rolled pickled steel, painted, is a much more economical material for jackets than planished iron, could have been more profitably employed, it seems to us, in determining the most economical insulator for boilers. It is not so important to know what is the best material for this purpose, as to know what is the most economical. Various forms of asbestos coverings are offered at one-half the cost of magnesia, and it is important for railroads to know the relative values, as non-conductors, of the various materials now on the market. This is strictly a laboratory investigation, and it is only by the careful and scientific work of the laboratory that these values can be determined. To attempt to get at the desired facts by any experiments on locomotives in service will only result in disappointment, and we trust that the committee on this important subject appreciates this fact.

The efficiency of high pressure steam for locomotives is a timely subject, when 210 pounds boiler pressure is used by several railroads. It is largely a theoretical subject and will have sound treatment by Professor Goss. The association shows itself energetic and up to the times when it selects a subject like this for its convention reports. It might be considered as a matter for the future by many, but it is coming rapidly; and to be posted on the elementary principles governing high pressure steam will make some practical problems seem easy, and opposition may be turned in its favor.

The committee on standard threads for pipe fittings will probably only report progress this year, the American Society of Mechanical Engineers having appointed a committee on the subject to cooperate with the Master Mechanics' committee.

If, as is asserted by Mr. Loud and those who favor the passage of his bill, the annual deficiency in the postoffice department is caused by the carrying of so much printed matter at one cent per pound, why is it that the cities, where nearly all the second class matter originates—cities like New York, Chicago and others—show an excess of receipts over expenditures in their post offices, reaching up into the millions?

NOTES OF THE MONTH.

Five years ago Superintendent of Motive Power Foster, of the Fall Brook road, equipped some of his locomotive boilers with stay-bolts drawn down in the middle. Recent examination of these boilers and their records showed that the life of these stay-bolts has been from two to three times as long as that of ordinary bolts, and Mr. Foster is now putting in the center drawn stay bolts in all his locomotives. Bolts 1 1/8 inches in diameter are drawn down to 11-16 and 7/8 inch bolts to 3/8. An inch of thread is left on the bolts.

\* \* \* \* \*

The Baltimore & Ohio has achieved a new distinction—that of running into the city of New York. This road now runs its freight trains over its own tracks into the metropolis. Years ago a line was built from Cransford Junction on the Jersey Central Railroad to St. George's, Staten Island, crossing the Kill Von Kull on a long bridge and trestle work, and all B. & O. freight, either inbound or outbound, was handled from that point. The recent extension of the limits of New York city has made Staten Island a part of Greater New York and the B. & O. now enjoys the enviable fame of being the only line from the west, except one, which has its own rails into the city of New York.

\* \* \* \* \*

One of the most cherished plans of General Manager Geo. W. Stevens, of the Chesapeake & Ohio Railway, since the rehabilitation of that system was begun some years ago, has been the establishment of a system of hospitals for the sick and injured employes of the road. The severe strain which this road, in common with others, has undergone during the past few years while preventing the complete consummation of the plan, served well to afford time to perfect all the details of such an elaborate undertaking. On December 1st, however, the first hospital was opened at Clifton Forge, and has since been in successful operation. It may be truly said that from its inception to the completed edifice the success of the undertaking has been due to the unceasing efforts of Mr. Stevens and his personal popularity with all classes of his employes.

\* \* \* \* \*

Dr. W. C. P. Brock, chief surgeon of the road, has had charge of all details connected with the establishment of the hospital, and much is due to his excellent judgment and skill. The building, a view of which we give herewith, was formerly a hotel



owned by the company. It is beautifully situated on a high plateau, surrounded by artistically laid off grounds. The offices, reception-rooms and dining-rooms are neatly and substantially furnished. There are no large wards where patients are harassed by the sufferings of those around them. There are only two beds to a room, and in serious cases only one patient to a room. These rooms are furnished with as comfortable beds as are to be found in the best hotels, with every other convenience necessary to the perfect comfort of the patient. There has been placed in the building a first-class steam passenger elevator. The patient unable to walk is taken from the ambulance, placed on a wheel stretcher, which is run upon the elevator, and carried to his room and gently slipped from the stretcher to bed with absolutely no lifting or handling. On the upper floor a large room, in the shape of a half circle, with large windows on three sides, has been remodeled and converted into the most perfect operating room in the south. This room has been made perfectly antiseptic; the floor is cement, gently sloping to the center, where a drain tile gathers all waste water; the walls are hardfinish, with seven coats enamel paint, and the room is furnished with the most improved and costly operating table and appliances for the

most difficult surgical operations. Dr. J. C. Wysor, a distinguished surgeon of West Virginia, has been appointed superintendent, and he has been given a full corps of competent assistant surgeons and trained nurses. He is now prepared to care for, and if needed, to perform any kind of operation for any employe of the C. & O., from general manager to track hand, and there is no distinction made; the brakeman and the superintendent will receive the same treatment.

\* \* \* \* \*

The Chesapeake & Ohio management, at great expense, has furnished the building and successfully launched it on its career of usefulness. The employes will pay a monthly assessment of from fifteen to fifty cents, according to the salary received, to aid in meeting the expense in keeping the enterprise fully up to the standard. Each employe should feel a deep interest in their hospital—for it is theirs. No one knows when it will be necessary for him to be sent there; and when he goes it is not to a general hospital and into unsympathetic hands, but he goes to his own, and into the hands of warm-hearted, skillful, sympathetic friends.

\* \* \* \* \*

The validity of a patent may be passed upon by state courts, the supreme court of the United States holds, in Pratt against the Paris Gaslight and Coke Company, when it is raised as a collateral question, as in defense to an action brought for the recovery of the purchase price of a patented article, and it is no objection to the jurisdiction of the state court that the question of validity may involve the examination of conflicting patents, or the testimony of experts.

\* \* \* \* \*

In personal injury cases juries should not be allowed, the supreme judicial court of Maine holds, in Sawyer against Shoe Company, to take into consideration the fact that an employer is insured against accidents, lest it increase their already strong tendency to be influenced by sympathy and prejudice.

\* \* \* \* \*

The obstacles against which those who are introducing acetylene as an illuminant have to contend are no more difficult to overcome than those which opposed the introduction of coal gas in the early days. That under certain conditions acetylene will explode is true, but so will ordinary gas. Explosive conditions can be avoided by the exercise of a reasonable degree of care in both cases and the wonderful illuminating power of acetylene makes it an object to inventors to devise methods of handling it that will reduce the possibility of accidents to a minimum. It is a curious and unusual fact that, so far, the use of acetylene has made more progress in the country than in the cities. In a lecture delivered before the Fire Underwriters' Association of the Northwest, September 30, 1897, Mr. A. H. Mulliken, president of the Illinois Acetylene Company, stated that at that time 200 farm houses in Illinois were lighted by acetylene. He also said that a plant for delivering the gas through mains as city gas is now delivered would be completed and put into operation within a few months.

\* \* \* \* \*

Current information concerning acetylene seems to bear out the following general statements concerning its properties: Pure acetylene when burned in the air emits a light, for an equal number of cubic feet of the gas burned, fifteen or twenty times greater than ordinary coal gas. This fact has been established beyond a doubt, and that the gas can be produced sufficiently cheap to enter a great field of utility also seems to have been proved during the last year. The fatal explosions that have occurred in using liquified acetylene naturally raise the question as to the danger involved in its use. Both in this country and in Europe a great amount of careful investigation has recently taken place in regard to the properties of this gas. Acetylene at ordinary pressures and temperatures is a gas, but at 59° Fahrenheit, and under 568 pounds pressure it becomes a liquid. In this condition, stored in cylinders like carbonic acid cylinders, that are used in connection with soda water fountains, for certain kinds of lighting it offers advantages over generating and using the gas at low pressures in the manner that ordinary illuminating gas is used. It is now well known that the very feature that lends danger to the use of the gas when used in a liquified condition is the same property which enables it to develop such a wonderful degree of light. This property is what is termed, technically, the endo-

thermic character of the compound gas. Acetylene is formed of two elements, oxygen and hydrogen. Ordinarily when two substances unite to form a new substance, as is the case when coal burns in a fire, and the oxygen of the air forms with the carbon of the coal carbonic acid gas, a great amount of heat is given off, which renders the fire hot; but in the case of acetylene the reverse is true. A great amount of heat is absorbed and disappears in the body upon its formation by the union of its hydrogen and carbon, and will only reappear upon the elements of the body separating, or upon the endothermic body burning. So it is that when acetylene burns it evolves not only the heat that would naturally come from the burning of the hydrogen and carbon that are in the gas, but it also evolves the heat that has been locked up in the gas at the time of its formation. It is for this reason that it can produce a hotter and more brilliant flame than any other known gas.

The great French chemist, Berthelot, has recently made some extensive investigations for the French government, into the conditions under which acetylene will explode. He has made the interesting discovery that when acetylene is under high pressure, or is in a liquefied condition, if an electric spark or a heated platinum wire be applied to it or a gun cap be exploded in its midst with no air present the acetylene immediately separates into hydrogen gas and fine soot or carbon with a tremendous evolution of heat. This produces great pressure and an explosion, if the vessel containing it is not strong enough to withstand the pressure. He has further shown that this does not take place when the acetylene is not under great pressure. In the latter case it is impossible to explode it unless it be mixed with air, but the explosion that would then occur would be of the same nature as would occur with any form of illuminating gas. Working at low pressure, therefore, acetylene is no more dangerous, in fact many of its properties render it less dangerous, than other forms of gas; but under high pressures, if exposed to heat, or when in a burning building, liquefied acetylene is sure to explode with tremendous force.

A change in the location of tools in cars is urged by the New York Board of Railroad Commissioners. The practice is, says the board, to attach boxes containing the tools to the inside ends of the cars, in many instances where it would be impossible to get at them in case of a collision. The board is convinced from observation and report that in the great majority of accidents resulting in damage to cars, the ends of the cars are most likely to be demolished or injured, thus rendering the tools unavailable. The board believes that the tools should be placed inside in the center of each car instead of at the end, and has made such recommendation to the railroad companies of New York state. Some objection has been made, based chiefly upon the cost of making a change, but no valid reason has, says the board, been presented for a modification of the recommendation. The board is seeking an amendment of the law so that it may insist upon obedience to its recommendation.

At the works of the Pintsch Gas Company in Berlin, Germany, there have recently been made many exhaustive tests on this subject. It was found there that a gas holder containing acetylene gas under moderate pressure, with a two-inch pipe attached to the holder, and with the gas inside of the pipe in communication with the gas within the holder, that such pipe could be heated to a white heat within a foot of the holder without causing any disruption of the hydrogen and carbon of the acetylene, beyond the point where the heat was applied. The contrary effect was produced when the gas was placed in a cylinder and submitted to a pressure of ninety pounds to the square inch. When a pipe only .02 of an inch in diameter was heated to a red heat at a distance of five feet from the cylinder, the cylinder was made to explode. Below thirty pounds pressure it was found impossible to explode it. At these works they have also found that they could destroy this explosive quality of acetylene by diluting it with other gases, after which they were enabled to compress it without any danger of explosion, due to the causes given above. Thus safe-guarding acetylene against explosions by using diluting gases, the German government is now employing it for lighting its railroad cars. In the manner in which they are using it the solder of the

containing cylinders will melt before the gas will explode. Hence it is we may hope to see acetylene come into real use, even though lack of knowledge has resulted in some deplorable accidents in cases where some of its well-intending friends have attempted to push forward its use in the liquefied form. It can as easily be distributed in other manners and under ordinary pressure, and danger thereby be avoided.

A law requiring the lighting of all passenger, sleeping and drawing room cars by electricity or gas, instead of oil, is urged by the New York Railroad Commissioners.

A criticism which we fear is only too well merited is made by the New York Railroad Commissioners who, in their last report, call attention to the insecure fastening of grab irons. "Western cars particularly," say the commissioners, "are deficient in this respect, due no doubt to the haste with which the irons were put on by order of the Interstate Commerce Commission a year ago. The irons should be firmly attached to the car by bolts, whenever practicable, with the nuts on the outside of the cars so that their becoming loosened may be readily detected. The method of attaching the irons to the cars by wood screws is extremely dangerous, and a number of accidents caused by the irons pulling out when attempts were made to use them have occurred." Another item of danger, say the commissioners, is the neglect, frequently reported, of not having the brake wheel properly and securely bolted to the brake stem on freight cars. Careful inspection should result in quickly remedying all such defects.

Some tests of preservative paints were undertaken last fall by a concern interested in securing proper protection of car trucks. The results are now available. In making the tests small black-iron pans were made and coated with materials as outlined below and filled with a saturated solution of rock salt and water, having a specific gravity of 1.130. These pans were exposed to the weather on September 25, 1897, and the same solution maintained continuously at varying depths until October 30, on which date, the liquid having become evaporated, the pans were not refilled. They remained exposed to the weather until November 16, on which date they were carefully examined with the following results:

- No. 1. Which was coated with two coats of carburet black, found to be in fair condition, showing very little evidence of corrosion.
- No. 2. Coated with two coats of Fuller's earth and linseed oil, manufactured by the testing company; found to be in very fair condition; equally as good as No. 1.
- No. 3. Coated with two coats of red lead and oil, found to be in fair condition, but giving evidence of paint peeling.
- No. 4. Coated with two coats of mineral paint and one coat of carburet black; was in very fair condition, but showed signs of corrosion and paint peeling.
- No. 5. One coat of red lead in oil and one coat of carburet black; covering peeled off badly.
- No. 6. Two coats graphite; covering had peeled off very badly, showing material did not adhere to the metal.
- No. 7. Two coats Assyrian asphalt; badly peeled and corroded.
- No. 8. Two coats of graphite as made by the testing company; condition good with few signs of corrosion or peeling.
- No. 9. Two coats white lead and oil and one coat carburet black; entire covering peeled off and surface badly corroded.

The above represents results to date. The investigation has, however, not been completed as yet.

The master car builders' committee on subjects which is called upon to present a list of topics to be referred to committees which are to report at the convention of 1899, has sent out a circular asking the assistance of the members of the association in preparing its report. It is requested that members will, as soon as possible, send to the chairman of the committee at Williamsport, Pa., a list of subjects which they consider of sufficient importance to be investigated by the committees of the association. In addition to this information the committee would be glad to have subjects suggested for informal discussion during the convention of 1899. In making

suggestions for subjects which are to be reported upon by the committees, it is desired that some thought be given to the subjects which have already received attention at the hands of the association through various committees. There are undoubtedly some subjects which have been investigated, and which contained all the information necessary at the time for giving a comprehensive view of the same, but on account of changed conditions it might be desirable to have the same subjects investigated further. The committee especially desires consideration of this part of the matter. The committee is composed as follows: E. D. Nelson, chairman; Wm. McWood, A. L. Humphrey.

The new coal plant that the Baltimore & Ohio Railroad is erecting at Sandusky, Ohio, will consist of an elevated track to be used either with side dump or drop bottom cars, the coal dropping into bins from which it will flow into buckets of four tons capacity placed upon movable platforms. Derricks of a capacity of ten tons each will lift the buckets to the vessel. There will be sixteen of these patent drop bottom buckets, and they will be handled by two of the latest steam revolving derricks and these machines will give the plant a capacity of about 300 tons of coal per hour at a minimum cost for the work and with a slight breakage. The plant will be in operation by April 1st.

The Central of New Jersey has issued a circular to enginemen and firemen announcing that premiums will be paid each month to the enginemen and firemen hauling the largest number of tons on freight trains between Mauch Chunk and tide water (Jersey City), 115 miles. The engine crew hauling the greatest number of tons in excess of the total rated capacity will receive \$125; the crew hauling the second largest number of tons, \$50; third, \$25. The enginemen will get 60 per cent of the premium and the firemen 40 per cent.

Some idea of the attention that the Baltimore & Ohio Railroad is now paying to its passenger traffic may be gained from the fact that during the past 18 months nearly 800 passenger cars received thorough and ordinary repairs, 696 being repainted. Nearly all of the equipment is now Royal Blue and most of it is equipped with Pintsch gas, the Pintsch light being used on local as well as through trains.

The Central Railway Club enjoyed a smoker after its annual meeting held Jan. 21. It was a very successful and happy affair. A peculiarity of the toast list and one that excited considerable hilarity was that no one knew that he was to speak until he was called upon nor did he know what subject he was to discuss until he was almost on his feet. Mr. E. Chamberlain was toastmaster and in opening recited Eugene Field's "Ashes on Our Slide." The toast-list was as follows:

"The Cuban Insurrection, and a Few Other Things," by F. B. Griffith, master mechanic of the Lackawanna; "Our Guests: Have You Them on the List?" by E. N. Lewis, manager of the Railway Master Mechanic; "How Can You Afford to Entertain the Members of the Central Railway Club and Leave Things Lying Around Your Shops, and What Induced You to Do So, Knowing So Little About Them?" by Walter Clark, manager of the Niles Tool Works; "The Merits of the Parker Shotgun as Compared With the New Regulation Cavalry Saber," by E. C. Phillips, editor of the Railroad Car Journal; "The Effect Upon the National Banking System By Withdrawing the Greenbacks," by H. C. McCarthy, general car inspector of the Northern Central; "The Proper Manner of Bringing Up Body Color for the Protection of Varnish, and the Results," by Charles Henry, manager of the French Spring Company; "The Most Desirable Wood for Inside Finish, and How to Preserve and Care for the Same," by Frank Barnard, of the B. M. Jones Company; "Which Is the Most Desirable for the Amateur, Too Much Hypo, Not Enough Pyro, or For on the Plate?" by W. J. Courtney, of the Peerless Rubber Company; "Is It More Desirable to Hunt for the Pole in Summer or in Winter?" by N. P. Hobart, of the Lappin Shoe Brake Company; "The Ladies," by John McKenzie, superintendent of motive power of the Nickel Plate.

After the banquet a number of the members departed on a special train for Hamilton, O., to visit the Niles Tool Works at that point. The party left Buffalo at 11:40 p. m. and reached Hamilton at 11 a. m. the following day, where the party was most cordially greeted by the management and ushered into the mammoth works. That the Niles Tool Works Co. are keeping up with the present requirements for the best tools was evident to all present.



One of the first tools to attract attention was a 42-inch swing double-head lathe for Manchester, England, to be used in turning steel-tired wheels. Five large lathes for driving wheel work were under construction for shipment to Alexandria, Egypt, also planers, boring mills, radial drills and special tools for shipment to St. Petersburg, Russia, Johannesburg, South Africa, Germany, France and other European countries. The foundry is one of the largest and best equipped in the country, having eight electric traveling cranes with capacity of 5 to 30 tons each. One of the special features of these works is their new gun shop for the construction of ordnance under the direction of the ordnance department of our government. A disappearing gun carriage (the first of 14 to be built) with gun mounted, occupied a place in the center of machine shop and was operated for the benefit of visitors, the gun and carriage complete weighing 110 tons. So exact are the requirements in the construction of the 12-inch rifled mortars now under construction that a uniform temperature is maintained in the shop day and night to avoid variation that a change of temperature would cause in the fitting of parts that compose the gun. The general improvement in the tools shown as to weight, strength, finish and improved attachments as compared with the tools of 15 or 20 years ago was one of the noticeable features. At noon luncheon was served and at 6 p. m. an elaborate dinner was served, after which speaking was indulged in. The party left for home at 7 p. m., feeling that they had been most royally entertained and much benefitted by the knowledge gained through the experience of the day.

LONG STROKE CYLINDERS AND PISTON VALVES.

BY GEO. W. CUSHING.

A full compliance with your request to supply such information as I am able to, relative to long stroke cylinders and to piston valves would necessitate many details of no especial general interest. Therefore in as brief a manner as is practicable I will mention only a few instances and facts bearing upon the subject, showing how one line of advance has been made in engine development, and also what has influenced the progress of it as revealed by my own experience and that of others.

Some little time ago the writer was in official charge, when it became necessary to consider specifications and designs of locomotives for special heavy service on the Northern Pacific Railway. The decapod type of simple engine, with 22x26" cylinders and 68" boilers, was decided upon and adopted for construction service and use upon the Cascade Mountain work of that road. This selection was made mainly because of the practicable distribution of the necessary weight on the greatest number of wheels. Experience with these engines was favorable, which influenced the decision for other locations and service when locomotives for mountain grades were being provided. Accordingly 22x28" consolidation simple engines with 72" boilers were supplied for several roads. In the matter of weight of these engines, 144,000 lbs. on drivers, all of the limit set by the interested road officials, was made available in the advance to 160 lbs. of steam pressure. The stroke of 28" utilized the useful effect of that pressure very closely and the results were very satisfactory. Time passed and the cylinders of these engines, which were generally worked up to their maximum capacity, became enlarged by reason of the wear and reboring of the same; and this enlargement, together with the decreasing size of the tires, developed a deficiency of weight when in this condition, using 160 lbs. of steam.

Some of these engines, in one instance, passed into the service of the Oregon Short Line and proved so satisfactory to the officials that when new additions to stock were made the general design and stroke was retained in the specifications made by Mr. J. F. Dunn, superintendent of motive power. Mr. Dunn increased the weight to some extent and increased the steam pressure to 180 lbs. These new engines proved to be, as were the other engines, excellent steamers; and the changes made in them improved their capacity in measure equal to the advance in steam pressure, as was to be expected.

The usual drift in, and advancement of, locomotive practice on railways generally has been developed in the manner stated.

Examples of long stroke in the past may be cited. Some engines built by Norris on the Camden &

Amboy road, built in 1848, had single drivers 8 ft. in diameter and cylinders, some 13x34 and others 14x38". The longest stroke in actual service in recent years was that of the engine "Governador," designed about 1886 by Mr. Stevens, then superintendent of motive power of the Central Pacific R. R., and built at the Sacramento shops of that company. These engines were 21x36", with 140 lbs. of steam pressure and 128,000 lbs. on drivers. This was an experimental engine and was hampered in operation by a pet valve motion, but it is evident also that the stroke was too long for the 140 lbs. of pressure of steam.

On the same road, the Central Pacific, some twelve-wheel simple engines were recently designed by Mr. H. J. Small, superintendent of motive power. These engines had 22x26" cylinders, 180 lbs. of steam pressure and 146,500 lbs. on the drivers, and they developed well in capacity and economical work.

In recent compound engine designs are also instances of successful work on this line, notably in the engines built for the Erie with 28" stroke and

engines"—and the idea carried that bigness is aimed at, I do not understand that this is so, nor that the question of types enters particularly into the problem. My understanding is rather that this talk represents simply an earnest effort to secure the best development of each type and size of locomotive when properly assigned and properly handled in service. The pressure, stroke and weight for this service is a matter for each interest to decide upon, as was shown in the instances first mentioned above.

In passenger service engines with high pressure will develop, under speed, to their best with long stroke and large drivers. I have noticed many instances in which increase in stroke of simple engines in this service might be made to good advantage. This being so in the old simple type, it may not seem strange that the defect in the new compound passenger engine should appear also. I am of the opinion that the matter of stroke is important in compound engines, especially in those of the two cylinder type; and that in passing 190 lbs. pressure a stroke of more than 24" must be considered

JUNE 22, 1866.]

ENGINEERING.

411

DAVIS'S PISTON VALVES.

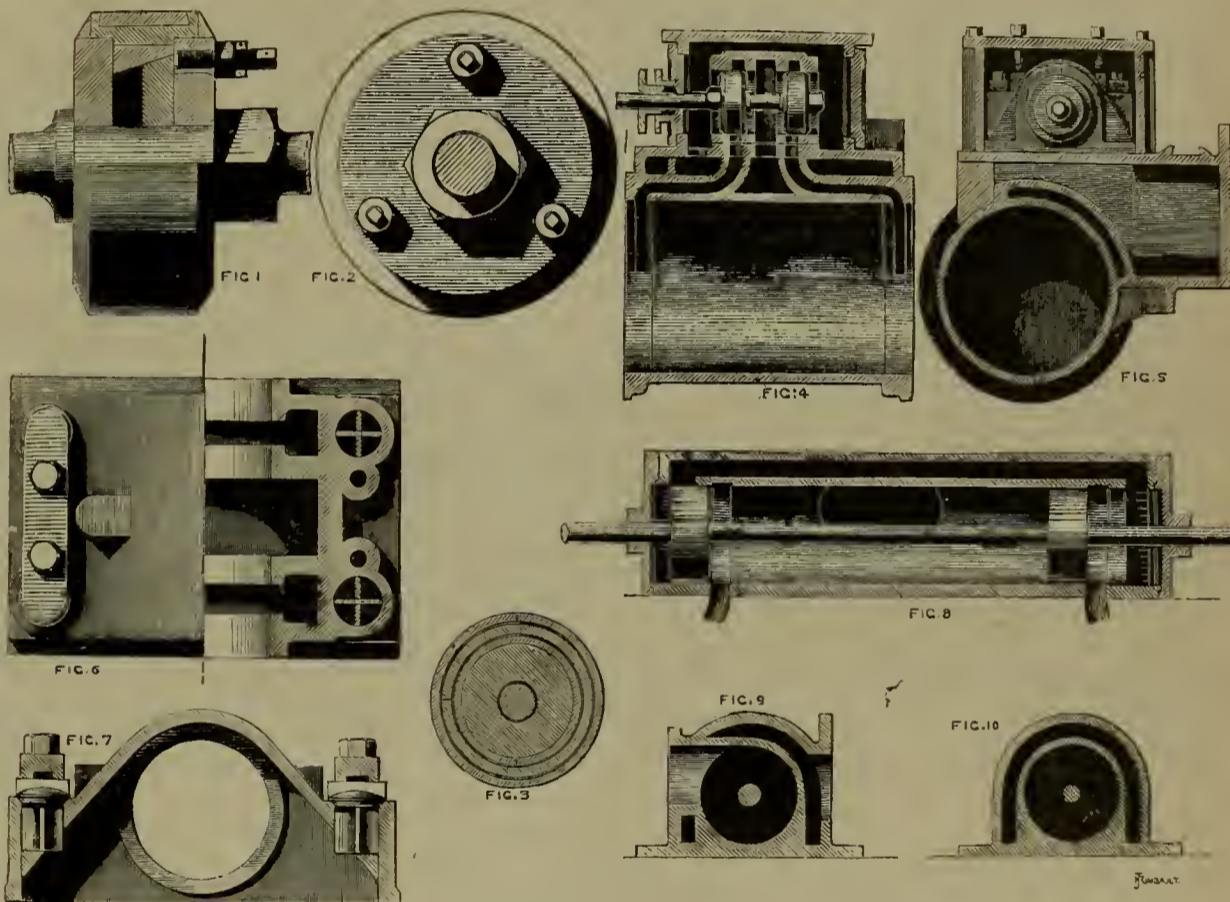

FIG. 1—DAVIS' PISTON VALVE. [See article on Long Stroke Cylinders and Piston Valves.]

for the Northern Pacific road with 30" stroke. A 26" stroke is getting to be very common with high pressure in new locomotives.

Concerning the locomotive designed by J. O. Pattee, superintendent of motive power of the Great Northern road, which was illustrated in the Railway Master Mechanic of January, 1897, I have no information except that noted in the illustrations and specifications. Undoubtedly, however, the same object was held in view as in the other cases mentioned, namely, the utilization of pressure to useful effect in a simple engine, the tonnage hauled and the cost of same being the test of value. These mastodons by Superintendent Pattee represent a development in this: That their combination of weight, steam pressure and stroke was excellent in a simple engine and exceeds other simple engines at present in service. These engines certainly appear to be well fitted to develop their value. The steam valve used is a good design of piston valve. The steam passages are properly bridged for the piston ring bearing, and the cylinder steam passages are well designed to lessen the evil effects of compression in high pressures. The boilers have a new feature in the front end spark arrester designed by Mr. J. Snowden Bell, which is also in use on B. & O. engines in heavy service. Taken altogether the performance of the Great Northern engines will excite great interest if made public.

In regard to the term now frequently heard—"big

for the best results, and that wheels of proportional size must be employed. Some little time ago I was greatly favored in being allowed to be present at an exhaustive pulling test on grade with some well designed cross-compound locomotives, 23 and 34x30" with 210 lbs. of steam pressure; and the very favorable result of the test with the very easy working of the engines at their maximum capacity, holding steam pressure at exactly maximum, confirmed this opinion.

It is a question to be carefully considered and worked out in the compound, at what pressure the benefit in ratio of cylinders ends and the benefit of stroke begins; but certainly in the instances above mentioned the relation or ratio of cylinders, stroke, and pressure of 210 lbs. appears to be well disposed of in heavy freight service. Increase the wheel diameter suitably and the same engine, no doubt, will be of equal value in passenger service.

Now a few words concerning piston steam valves. The design of valve in the Great Northern engine is but one of many. The piston valve is an old affair even for locomotives, and, having lain dormant for years in this connection, it again appears with the drift of locomotive practice toward high pressures of steam. The advantage of the piston valve develops best with high pressure as its per cent of non-balance is small, remains constant and is not affected injuriously by the increase of pressure. Years ago the piston valve was used in the west on

locomotives, and among the many experimental valves used there were found those which were successful in operation, producing good results. This was notably so in the case of some engines on the Prairie du Chien Railroad (now the Chicago, Milwaukee & St. Paul). At the shops of this road in Wisconsin a number of piston valve engines were built or rebuilt; and piston valves were also adapted to old cylinders. These engines were noted for their smartness and general good work with trains.

One of the early designs of valves was that of Mr. Thos. S. Davis of Jersey City. This was illustrated in London Engineering for June 22, 1866, and it may be interesting to reproduce this illustration as representative of the early times (see Fig. 1). A difficulty which developed with this design and with

valve. This balance rendered the slide valve form acceptable at the then low pressures standard on engines in the west.

In the meantime the piston has gained a position at the head in steam vessels, small and large, naval and commercial, at all pressures the world over. It is used in fast steamers crossing the ocean, the entire distance being passed, in some instances, without lubrication. It is also used in the best and fastest electric engines running almost continuously. And in these engines, with the increase in pressure it has really become a necessity on land and sea.

The piston valve has in late years been improved in form, eliminating the features which caused objections to the old form, and it is again coming into use on locomotives. The Baldwin Locomotive

fitted to an old engine; the other has its valve chest and cylinder cast together—similar to the Brooks design—the steam exhausting around the cylinder and steam-jacketing it effectually. In some tests of these valves at 150 lbs. pressure made by Mr. Warner at Tacoma, June, 1895, a very sensitive dynamometer was arranged by him and attached to the valve stems to indicate pressures on the plain valves, the ordinary balance valve, and the piston valve each in turn, on the same locomotive. This locomotive was a 19x24" engine and the tests were made in train service and at the same pressure of steam. The result showed the plain valve to be wholly non-balanced, the ordinary balance valve to be at 57 per cent non-balanced and the piston valve at 7.2 per cent of non-balance. The difference in total pressure, or it may be stated the pull on the valve stem necessary to operate the valves, was in ratio of 2,025 lbs., 1,222 lbs. and 285 lbs. respectively—the latter with the piston valve of course. In the case of the plain valve of course this pressure on the valve increases with the boiler pressure, as it does with the ordinary balance valve also; but in this case the latter is directly influenced by the more or less perfect non-balance practicable in the design used. The ordinary balance and plain valves are affected in lubrication according as this non-balance is more or less perfect and regular. The piston valve on the other hand is not affected, within reasonable limits of time, by imperfect lubrication; and, what is more to the present point, it is not affected by an increase of steam pressure.

In using piston valves they may be made in length to correspond to the length of stroke. Some waste space, however, is necessary in all valves to cushion against compression, and this must be worked out in the plan. Usually in a 24" stroke engine, with a 19" cylinder, the waste passages figure about 9 per cent the area of the steam cylinders. This, in the case of the piston valve, may very likely be reduced to 7 per cent, so that the waste on long stroke piston valve cylinders of any stroke need not be greater than with the 24" stroke.

I would say, generally, in closing, that the increasing of steam pressures above 190 lbs. appears likely, until in simple and compound locomotives a limit of useful effect is reached; and that this advance of pressure seems to open a way for good designs of the piston steam valve. The piston valve heretofore referred to—that designed by Mr. H. H. Warner and shown in Figs. 2 and 3—is, I may say, free from mechanical defects of construction so far as developed in more than two years' of practical service. I may say further that it is free of interference with any existing valid patent and is not itself patentable.

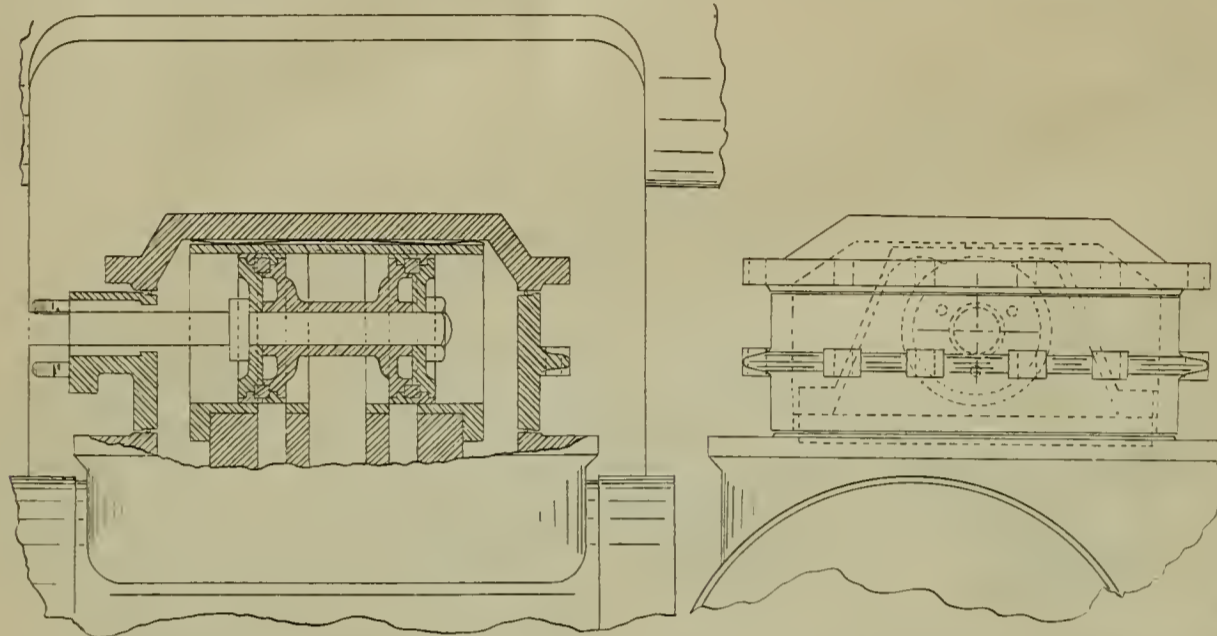

FIG. 2—WARNER'S PISTON VALVE. [See article on Long Stroke Cylinders and Piston Valves.]

others then in use was the rapid wearing away of the valve cage at the port openings, due in part to the absence of bridge strips in the port openings as ring bearers for the pistons. It was supposed also that the valve piston rings needed adjustment the same as those of the steam cylinder piston. Occasionally this adjustment was faulty and, cramping the free motion of the valve, over-balanced all the advantage of the piston for the time being. The tallow then used for lubrication troubled the piston valve as it did also the plain D valve. The cause which more than any other, however, led to the disuse of the piston valve after these early experiences was the introduction of the balance on the slide

Works and the Brooks Locomotive Works use piston valves on simple and compound high pressure engines; and in several instances these valves are being used by roads which have fitted them to cylinders in both new and old engines.

One of the best designs of piston valves is that produced by Mr. Henry H. Warner, master mechanic of the Pacific Division of the Northern Pacific Railway at Tacoma, Wash. Mr. Warner experimented in times past with piston valves and latterly made the present design as shown in Fig. 2; the detail of this valve is shown in Fig. 3. This valve is used on two 19x24" engines under Mr. Warner's charge. One is like the design shown and is

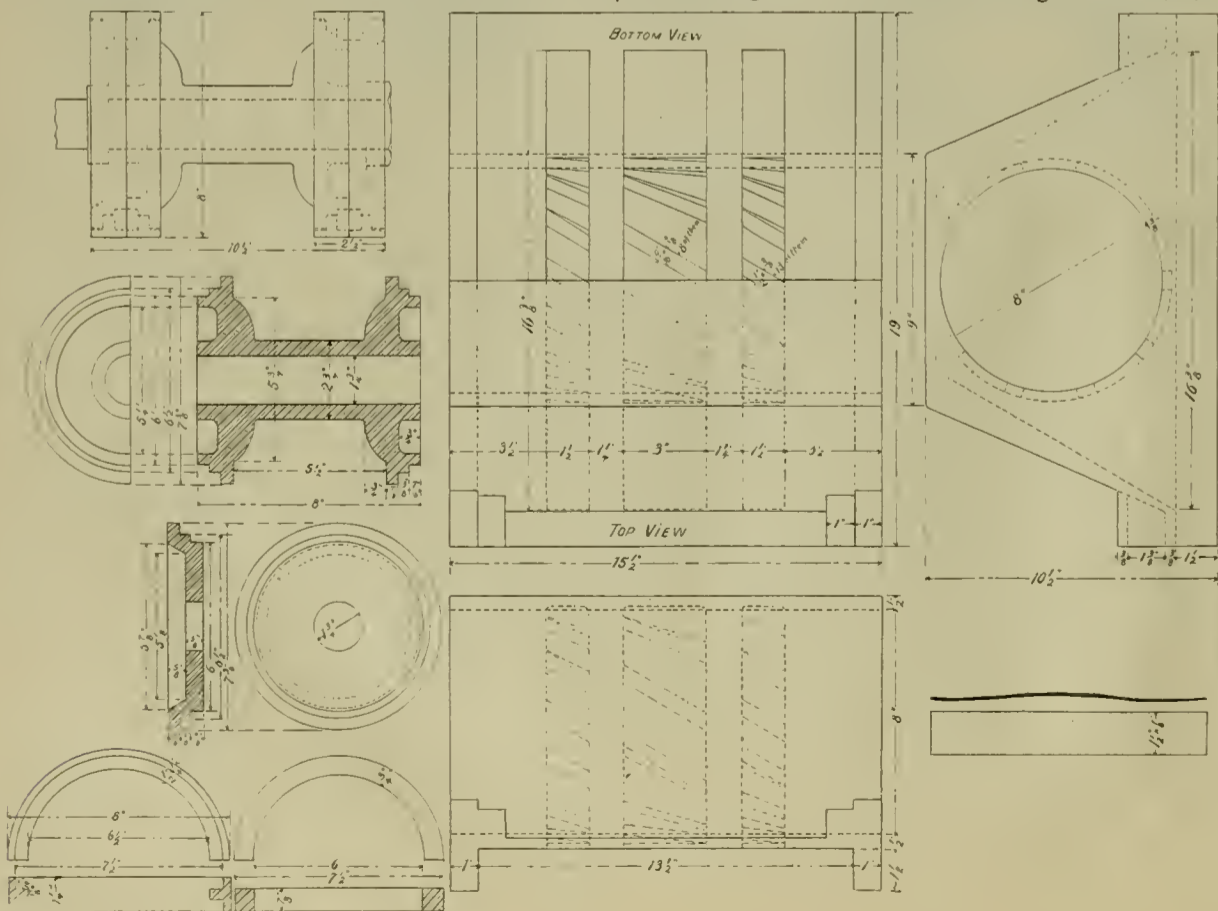

FIG. 3—DETAIL OF WARNER'S PISTON VALVES. [See article on Long Stroke Cylinders and Piston Valves.]

LOCOMOTIVE INJECTORS\*

BY J. A. BISCHOFF.

The knowledge of the capacity of a moving jet of steam or other fluid to produce a vacuum in properly formed ducts, for the purpose of raising air, water or other fluids, and conveying them from one place to another, may be traced back to the time of Venturi, Nicholson and others. Nevertheless it must be admitted that the eminent French engineer, H. J. Giffard, was the first to conceive the idea that the kinetic energy (moving energy or momentum) of a moving mass of fluid could be utilized to overcome the static energy (resistance) of a mass of water under boiler pressure, so that the first mass of fluid would enter such boiler against the resistance of the second.

The terms "kinetic energy" and "static energy" may not be absolutely correct in a mechanical sense in this connection, but they may be used here for the purpose of designating the difference between the conditions of the two masses of fluid under consideration, which will receive notice further on.

THE ESSENTIALLY ACTIVE PARTS OF AN INJECTOR.

1. A steam nozzle, through which the operating steam from the boiler enters the injector.
2. A combining and condensing nozzle, in which the steam and feed water meet, and in which the steam condenses and transmits its dynamic force to the water.
3. A delivery nozzle, in which the maximum velocity of the combined mixture of steam and water is attained and subsequently reduced by means of the expanding curves or tapers and increasing cross sections, to the velocity and pressure in the boiler pipe.

If these three parts, which are to be found in every injector, are looked upon as the essential components of an injector, the Marquis Mannanry d'Ectot must be considered the inventor of the injector. In 1818 he was granted a French patent for a steam jet apparatus.

\*Paper read at the Locomotive Foreman's Club (Chicago), January 18, 1898.

which was capable of raising water from a tank and delivering it into a second tank. After d'Ectot, the French engineers Pelleton and Bourdon (of steam gauge fame) published various inventions of a similar character.

On Mar. 8, 1858, H. J. Giffard was granted his first patent for an injector, to be used as boiler feeder. The difference between his apparatus and those of former inventors, consisted mainly of a certain distance between the outlet orifice of the condensing nozzle and the inlet orifice of the delivery nozzle, which is called the overflow space and which communicates with the outer atmosphere.

In starting the injector, more water, as a rule, enters the apparatus than the injector is capable of delivering against the back pressure of the boiler, and if there were no communication with the atmosphere, the injector would "break", that is refuse to work, and the steam blow back into the tank from which the water is taken, because the steam would naturally follow the line of least resistance. By providing for an overflow space between the condensing and delivery nozzles, the surplus water is given an opportunity to escape, until the jet of combined steam and water has attained a sufficient velocity and over pressure to open the boiler check valve and deliver the jet into the boiler. After the apparatus has been started and is in operation, the waste of water may be avoided by cutting down the supply, until no more water is seen at the overflow, or the overflow is stopped automatically, according to circumstances and the type of the instrument used.

Giffard's invention, therefore, consisted in the important discovery that, in order to deliver water through an injector into a boiler, by means of steam taken from the same boiler, the jet must first overflow into the atmosphere. Injectors made prior to Giffard were, in fact, based upon the same principle as that of Giffard's injector, but were unable to deliver against pressure.

In common with all new inventions and improvements, great difficulty was experienced in obtaining a fair trial of the merits of the injector, and in many cases the exaggerated claims of its friends interfered as much with it as the severe and condemning criticism of its enemies. The advantages, however, of the new method of boiler feeding, the simplicity and efficiency of the apparatus, and the comparatively small expense of installation and maintenance, were soon appreciated by steam users, and today the injector is among the most popular boiler feeding apparatus in use, and still deserves the high praise bestowed upon it in 1859 by M. Ch. Combes, Inspector General and Director of the School of Mines at Paris: "It is without doubt better than all devices hitherto used for feeding boilers, and the best that can be employed, as it is the simplest and most ingenious."

Soon after Giffard's injector had been placed on the market, the manufacture of injectors became a most important and extensive industry in the United States as well as in Europe. Hundreds of thousands of injectors have been manufactured for various purposes, and today there is hardly a locomotive engine running anywhere in the world which is not provided with at least one injector. Great numbers of steam vessels and many stationary plants are equipped with injectors as boiler feeders, hence it is of the utmost importance that every engineer, stationary, marine and locomotive, should thoroughly familiarize himself with the principles which underlie the operation, management and construction of injectors.

#### THE ACTION OF THE INJECTOR.

It is very difficult, almost impossible, to properly explain the seemingly paradoxical action of an injector, without entering into mathematical demonstrations, which would lead too far for the purposes of this paper. It will be necessary, therefore, to confine ourselves to stating the results of such mathematical deductions.

The simplest method of considering the action of the injector is to consider it from a purely mechanical point of view, as an apparatus in which the force of a jet of steam is transferred to a more slowly moving body of water, resulting in a final velocity sufficient to overcome the pressure from the boiler. We will consider, for a concrete example, a boiler containing steam at 120 lbs. pressure. According to the laws governing the flow of steam through properly built channels, the steam discharging through the minimum diameter of the steam nozzle into the atmosphere or steam of lower pressure, will reach a velocity of about 1,400 feet per second, but when it discharges into a combining tube in which there is perhaps a 20-inch vacuum (which is not unusual) the velocity will be about 3,500 feet per second. In supplying water to the injector at the rate of 13 lbs. to 1 lb. of steam, which is a fair performance at the pressure stated, the water will receive the impulse of the moving steam, condensing the latter, and the two fluids move along together through the delivery tube with a final velocity which is very much less than the original velocity of the steam jet. This final velocity is, under the conditions named, about 170 feet per second. In order that the injector should work properly, this velocity must be greater than that with which the water in the boiler would issue from the delivery nozzle under a pressure of 120 lbs. per sq. in. This velocity is equal to that due to the head, corresponding to 120 lbs.

pressure, or about 133 feet per second. It will be seen, therefore, that there is a considerable margin of available energy in favor of the moving mixture of steam and water as against the "stationary" resistance, under the same pressure, of the water in the boiler. An injector must have the proportions of steam, water and delivery areas so designed that the velocity of the moving mixture of steam and water will be greater than the velocity at which a jet of water would flow from the boiler under the same pressure. If the weight of water supplied is too great, the steam will not have power to give the water the required surplus of velocity; if there is an insufficient supply, the volume of steam will not be sufficiently reduced by condensation to pass through the nozzles, and in neither case will the injector perform its functions properly.

#### CAUSES WHICH PREVENT INJECTORS FROM WORKING.

In this direction there are principally two general conditions to be considered:

1. The injector refuses to lift promptly or to lift at all. This may be caused by leaky joints in the suction pipe; by improperly packed water valve stems; by dirty, clogged-up strainers; clogging of the lifting steam passages in the injector; hot suction pipe, etc., etc.

In connecting up an injector, either when new or when it has been taken off for repairs of some kind, particular care should be exercised in testing the suction pipe for tightness, by well known methods.

Particular attention should be paid to the strainer; it should be taken out, examined and cleaned before each trip of the engine. "An ounce of prevention is sometimes preferable to a pound of cure." Cheerfully undergoing a little trouble may be the cause of preventing a good deal of annoyance, anger and expense.

"Hot suction pipe" is usually the result of leaky steam valves or leaky boiler checks. If you notice any leaks in either, have them attended to without delay. The longer repairs are put off, the more aggravated will the trouble become, and the higher will be the cost of repairs, not taking into consideration the danger of something serious occurring during a run, as a result of neglecting timely repairs.

2. The injector lifts the water but refuses to force it into the boiler, or forces it partly into the boiler and partly through the overflow. This may be caused by insufficient water supply as a result of improper size of the suction pipe, hose or tank valve opening, by clogged up strainer, obstruction in the nozzles (pieces of coal, scale from steam pipe, waste, etc.), insufficient opening of the boiler-check, "sticking" of the boiler-check or of the line-check valve of the injector, by insufficient steam supply or by wet steam. The pipes of an injector should never be smaller than the size called for by the injector connections, more especially the suction pipe and the clear openings of the tank valve. Sharp bends in the pipe should be avoided as much as possible. In piping an injector, the pipes, but more especially iron pipes, should be thoroughly blown out before connecting up, to remove scale and dirt from the pipes.

The "sticking" of the boiler-check or of the line-check valve is mostly caused by sediment and scale resulting from bad water. Incrustation of the nozzles by limey deposits around the points of the nozzles will also cause the injector to spray at the overflow, and result in improper action generally. The effects of bad water may be partly if not entirely eliminated by cleaning the injector frequently, and by placing it occasionally into an acid bath.

Injectors work best with dry steam, for which reason the steam supply pipe should be attached to the highest point of the boiler. If steam is taken from a fountain to which other steam appliances are connected, the volume, or cubic contents, of the fountain must be large enough to more than amply supply all appliances connected to same.

#### SUGGESTIONS.

Undeniably the prompt and reliable feeding with water, of the boiler of a locomotive engine, is one of the prime conditions for the reliability of the service in general. Reliable train service cannot be conceived without the assurance of a reliable water feed to the boilers under all conditions and at all times, as this is the foundation of the prompt and ample generating of the necessary motive power; still it is a fact that designers of locomotive engines, as a rule, do not pay that attention to the injector which its importance calls for, and beyond specifying the type and size desired, hardly any other attention at all is paid to its most desirable location and other points, with a view to assisting in the development of the best qualities and assuring reliable service. Injectors, as any other product of human endeavor, are subject to defects and failures; the very mechanical nature of the instrument calls for considerations in its arrangement and that of its accessories which, when properly considered at the time of building the engine, would go a long way toward preventing annoyance, expense and sometimes serious inconvenience. It is perhaps within the province of this paper to point out some features in this direction.

The little conical, copper strainers inside of the suc-

tion pipe should be abolished, as they are a nuisance and the cause of more trouble than they get discredit for. If a premium had been put upon designing something to readily catch and retain any dirt in such manner as to materially reduce the water supply, these strainers would undoubtedly receive first prize. The very fact that they are inside of the pipe is objectionable. The strainers should be outside of the pipe, either directly below the tank valve or well, or at the end of the suction pipe, between pipe and hose. The size of the strainer should be such that even if half filled with leaves or other matter, it should still retain the full pipe capacity. It should also be so designed that it could be readily cleaned at any time and in a very few minutes. Such strainers can be obtained in the market, and their cost would be more than compensated for, by avoiding troubles often caused by their absence.

Some types of injectors are not provided with any water valve in the suction pipe. In cases where such valves are provided for in the injector, they are not considered as shut off valves, but merely as regulators, by means of which to regulate the supply of feed water at certain pressures. For this reason some of these valves are so constructed that they will form a tight joint when closed down. It happens then occasionally, that in cases of an accident to the boiler-check, which prevents its tight closing, and with the line-check valve of the injector leaking, the water cannot be kept in the boiler, and the engine must be side-tracked. To provide for such emergencies, it would be very advisable to place a properly sized shut-off valve in the suction pipe, between pipe and hose. With such valve at hand and with the over-flow of the injector closed, the water could not leave the boiler.

It is a very usual but not a good practice to place injectors outside of the cab, and run long operating rods from the injector handles into the cab. These extension rods, as a rule, are not connected up very carefully, and even if they are, the injector cannot be as readily started or as well regulated as when the operating handles are close to the injector, and therefore under better control of the operators. The result of this arrangement is a waste of time in starting the injector, and considerable waste of water through the overflow. Very often the overflow cannot be observed, and the operator judges by the sound whether the injector operates properly or not, and with some types of injectors he is compelled to "feel" the suction pipe in order to convince himself of the operative condition of the injector. All this cannot be conveniently done with the injector removed from the engineer. The proper position of the injector is inside of the cab. Room can always be provided for it. The objection of the overflow splashing or the steam clouding the windows of the cab, can be overcome by providing a larger overflow pipe than is usually employed. With a large enough overflow pipe, the overflow connection can be made perfectly tight.

Most of the trouble with injectors comes from improper, slow, lifting, especially when the water in the tank is low, caused by circumstances for which the injector proper is not responsible, such as bad boiler checks, leaks in the suction, obstructed strainer, etc. To reduce inconveniences from this source to a minimum, injectors should be placed as near to the water level in the tank as possible. On some roads the admirable practice prevails of placing the injectors a foot or two below the highest level of the water in the tank. The idea in this direction is the "non-lifting" injector, placed below the lowest water level in tank, not only because the source of most of the trouble with injectors, the lifting, is entirely eliminated, but because by keeping the injector submerged in water, it will be kept comparatively cool, the precipitations from bad water will not be "baked" on, and the injector will wear considerably longer without repairs.

The proper consideration of these and other minor points in the equipment of locomotives with boiler feeders, would undoubtedly result in improved service, in the prevention of many unnecessary annoyances, and in the satisfaction of all concerned in the question.

#### DANGERS IN ANNEALING.

Mr. F. A. Pratt, president of the Pratt & Whitney Company, in an article contributed to the last issue of Sparks from the Crescent Anvil, writes of the dangers of annealing, as follows:

We have most of our tap steel annealed at the place where it is made. We have had it done in this way for some years, with the exception of our long stay-bolt taps, which we have found require more care in annealing, than the steel-makers will give it.

More steel is injured, and sometimes spoiled, by over-annealing than in any other way. Steel heated too hot in annealing will shrink badly when being hardened; besides, it takes the life out of it. It should never be heated above a low cherry-red, and it should be a lower heat than it is when being hardened. It should be heated slowly and given a uniform heat all over and through the piece.

This it is difficult to do in long bars and in an ordinary furnace. The best way to heat a piece of steel, either for annealing or hardening, is in red-hot, pure lead. By this method it is done uniformly and one can

see the color all the time. We do some heating for annealing in this way and simply cover up the piece in sawdust, and let it cool there, and we get good results. All steel-makers know the injurious effects of over-heating steel and of over-annealing, but their customers are continually calling for softer steel and more thorough annealing. Until users are educated up to the idea of less annealing and to working harder steel, both will suffer, for the user will continually complain of poor steel.

Several years since we caught on to the fact that steel was injured by over-annealing, and that good screw-threads could not be cut in steel that was too soft: our men would rather take the steel bar direct from the rolls without any annealing than to take the risk of annealing. At present we get it from the makers in passable condition, but not as it should be, and unless the steel-makers find some way to heat the bars of a uniform heat, and at a low cherry-red, we must either use it raw from the bar or anneal it ourselves. We find, also, that this soft annealing makes a much greater shrinkage and spoils the lead of the thread, and that from the bar without any annealing there is very little trouble in this respect.

When O. H. and Bessemer machine steel were first introduced, they were poorly made and hard to work. Users constantly urged the makers to make it softer, until when a maker could say his steel was as soft as iron, and not more than .10 or .15 of one per cent. carbon, he had the market. This company found out early that this soft machine steel was almost worthless. A shaft would bend easily in working and if a lead-screw was to be cut it was not possible to get a smooth thread and a good finish.

Now we either make shafts and spindles of cast-steel of a high carbon, or of machine steel of about .50 per cent. carbon, without annealing. Our men kicked at first, but now they complain if it is soft, because they cannot cut a good thread and cannot keep it as true.

**STANDARD CONSOLIDATION LOCOMOTIVE--A.  
T. & S. F. RY. CO.**

There will be built for the Atchison, Topeka & Santa Fe Railway during the present year twenty-one consolidated locomotives with 21x28-inch cylinders for heavy mountain service, from the designs of Mr. John Player, superintendent of machinery. Twelve or more of these engines will be built at the Topeka shops of the company. Five are now under construction by the Dickson Locomotive Works at Scranton, Pa. The general design and many of the important details are given in the accompanying engravings. In general these twenty-one engines will be similar in construction to the eight built at the Topeka shops during the last six months of 1897 with the exceptions of an increase in the diameter of cylinders from 20 inches to 21 inches, and the greater use of cast steel for many details to replace forgings. The engines built during 1897 have fulfilled all expectations and met the requirements of the service for which they were designed, and it is the intention to use these new engines in the same service.

The boiler is of the form known as straight top, with an inside diameter of 66 3/4 inches at smoke box end. The shell sheets are of one plate for each course, with longitudinal seams quadruple riveted with butt joints; the waist connection seams and junctions of waist with fire box are double riveted. The smoke box is 68 inches diameter, and 65 11-16 inches long from front flue sheet. A pressed steel front and door are used. The dome is of cast steel and made in two parts, the base extending up to the line of the throttle valve. The top cover rests upon this base. This arrangement is designed to facilitate repairs to throttle valve, connections, and dry pipe. We give the dome in considerable detail in Fig. 3. The fire box rests upon the top of the frame, is 103x42 inches inside of mud ring, with a width at crown sheet of 55 inches. The water spaces are four inches all around. The mud ring is made of cast steel double riveted. The crown bars are A. T. & S. F. standard.

The method of securing the cylinders and tying the frames at this point is worthy of mention. The front frame is secured to the cylinder saddles by two bolts on each side, passing through both frames and saddle. The lower frame is also bolted in the usual manner by horizontal bolts passing through the lip of saddle. All bolts are made with driving fits. The cast steel frame braces are machined to fit over the frames, but are 1-32" short; they are then heated to expand them and then bolted to place. These braces are placed just in front and behind the saddles. Besides being thoroughly bolted to the saddles the frames are securely keyed to take the heavy strain from the saddle bolts. The method of applying the support for the front end of the fire box and

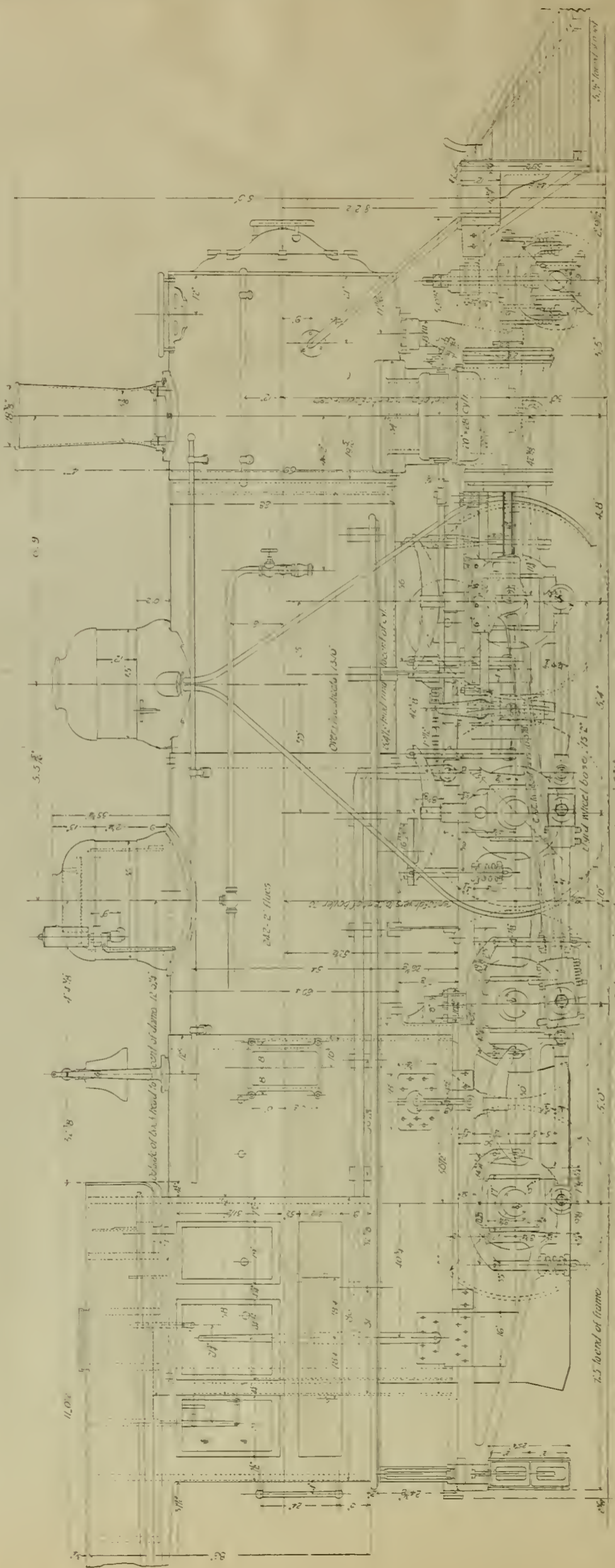

**FIG. 1 STANDARD CONSOLIDATION LOCOMOTIVE, ATCHISON, TOPEKA & SANTA FE RAILWAY.**

allowing for expansion is also worthy of mention. A frame brace of cast steel is placed immediately in front of the fire box; this brace supports this end

reverse levers; pistons, cross heads, eccentric blades, mud drums and domes. The tender is made with a steel under frame.

**BOILER.**  
Boiler, straight top, carbon steel.....66 3/4 in. dia.  
Boiler, shell sheets.....1/2, 3/8, 11-16 in.

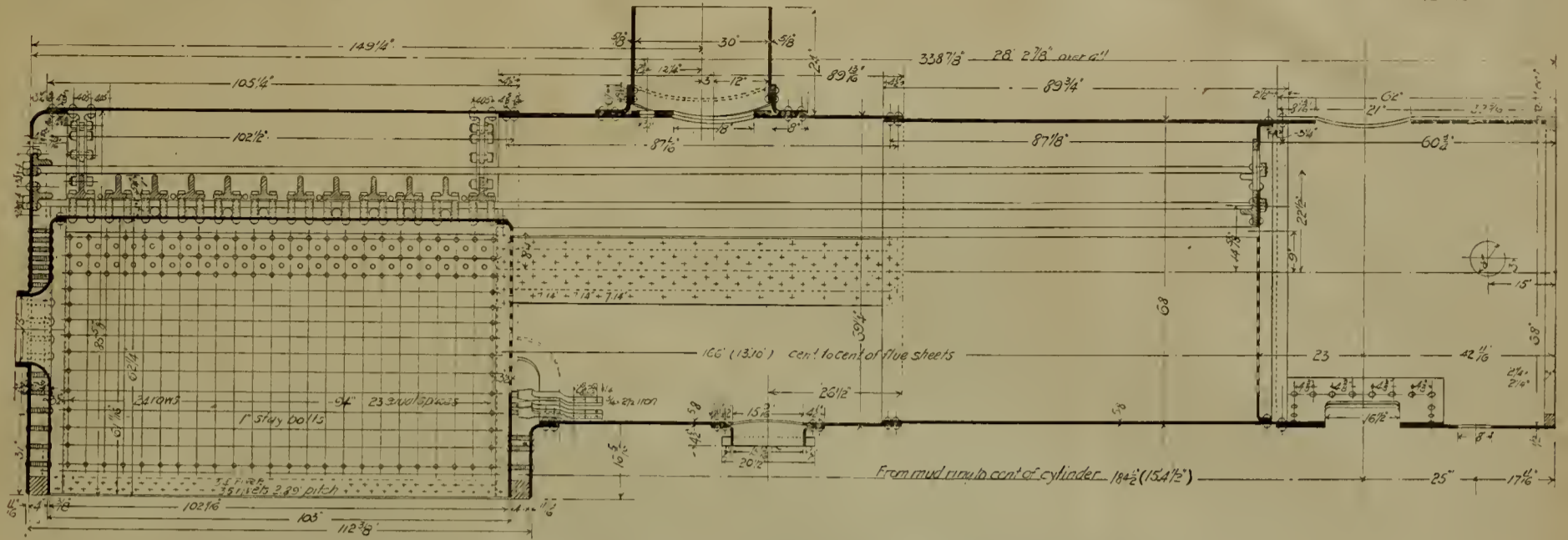

FIG. 2—BOILER OF ATCHISON, TOPEKA & SANTA FE CONSOLIDATION LOCOMOTIVE.

of the fire box, by means of suitable expansion pads which are fitted into slotted grooves made to receive them. This secures the boiler laterally and ties the frames securely at this point. (See Fig. 5.)

The air pump is placed under the fireman's side of the cab and secured to the cab bracket. Two steam gauges are placed in the cab, one in the usual position and another on the boiler head for the fireman.

Magnesia sectional block lagging is used on the boiler, jacketed with No. 18 steel, painted both sides,

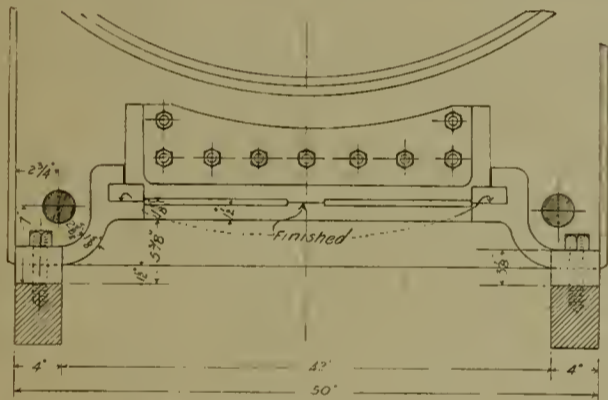

FIG. 5—FRAME BRACE, A. T. & S. F. CONSOLIDATION.

The back head is also lagged and jacketed. The dome casings and lagging are similar to those of the boiler. The cylinders and saddles are thoroughly lagged with asbestos.

Cast steel is used for the following parts: Frame in one piece from connection back of saddles; engine truck frame, pedestals, equalizers and radius bar; belly braces, guide yokes, frame braces, expansion pads and supports; tumbling shaft, reverse levers and rocker arms; all equalizer bars for the main equalizing system; links, link blocks and link hangers; brake shoe hangers and the fulcrum for

The tank has large water and coal space, the tops of the legs being sloped from the outside to the center to allow the coal to roll into the pit as the pit is emptied. This is the standard tank for the company. The tender is carried upon the Player patent cast steel truck frame and bolster.

**GENERAL DIMENSIONS.**

- Wheel bases, driving wheel.....15 ft. 2 in.
- Wheel bases, total .....23 ft. 3 in.
- Wheel bases, tender .....16 ft. 6 in.
- Weight of engine on drivers.....143,500 lbs.
- Weight of engine on engine truck.....16,500 lbs.
- Weight of engine total about.....160,000 lbs.
- Driving wheels, 8 in number, diameter.....57 in.

**Cast Steel Centers.**

- Tires.....3 1/2 inches thick, 4 flanged 5 1/4 inches wide
- 4 bald 7 inches wide
- Axles, hammered iron journals.....8x9 in.
- Pins, main.....6x6 3/8, hammered iron, case hardened
- Pins.....main coupling, 6 1/2x5 in.
- Pins.....front and back, 4 1/2x4 in.
- Pins.....second pin, 5x4 in.
- Rods, hammered iron, front end, main, solid, parallel rods, front and back ends solid, second and third connections straps.

- Engine truck, cast steel frame, pedestal, equalizers, etc.
- Engine truck, wheels steel tired.....30 in. dia.
- Engine truck, axles hammered iron, journals, 5 1/2x10 in.
- Engine truck, springs, coil.....4 in number

**CYLINDERS.**

- Cylinders .....21x28 in.
- Cylinders, center to center.....86 in.
- Pistons.....cast steel, hollow
- Pistons, rod hammered iron.....3 3/4 in.
- Pistons, rod extension, 35 in. long.....3 in.
- Valves .....Richardson, balanced
- Valves, Travel.....5 1/2 in.
- Valves.....lap, outside 7/8, inside line and line
- Valves.....lead, front line and line; back, line and line
- Ports, steam.....15 1/2x18 in.
- Ports, exhaust .....3x18 in.
- Bridges .....1 3/8 in.
- Exhaust nozzle single.....5 1/4 in. dia.

- Boiler, throat sheets.....11-16 in.
- Boiler....cylinder courses butt joint, quadruple riveted
- Boiler.....courses lap joint, double riveted
- Boiler.....smoke box 65 11-16 in. long by 68 in. dia.
- Boiler.....front pressed steel

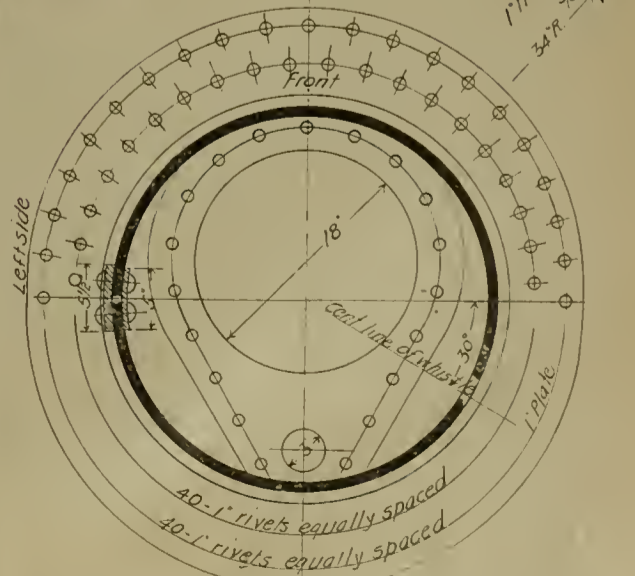
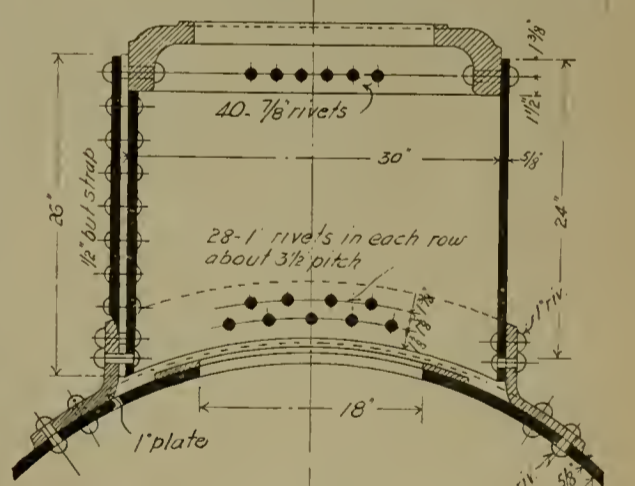
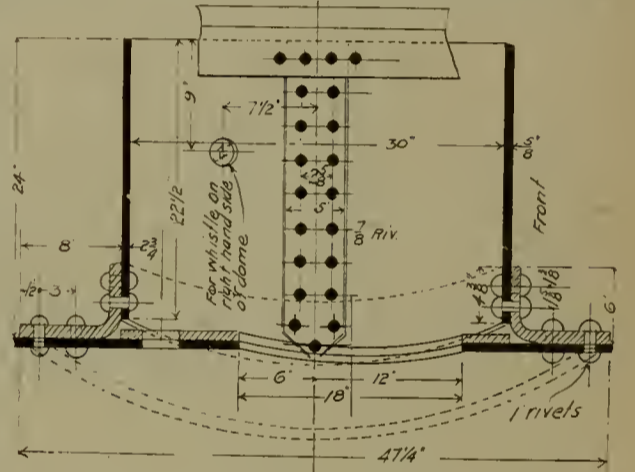

FIG. 3—DOME AND FASTENINGS A. T. & S. F. CONSOLIDATION.

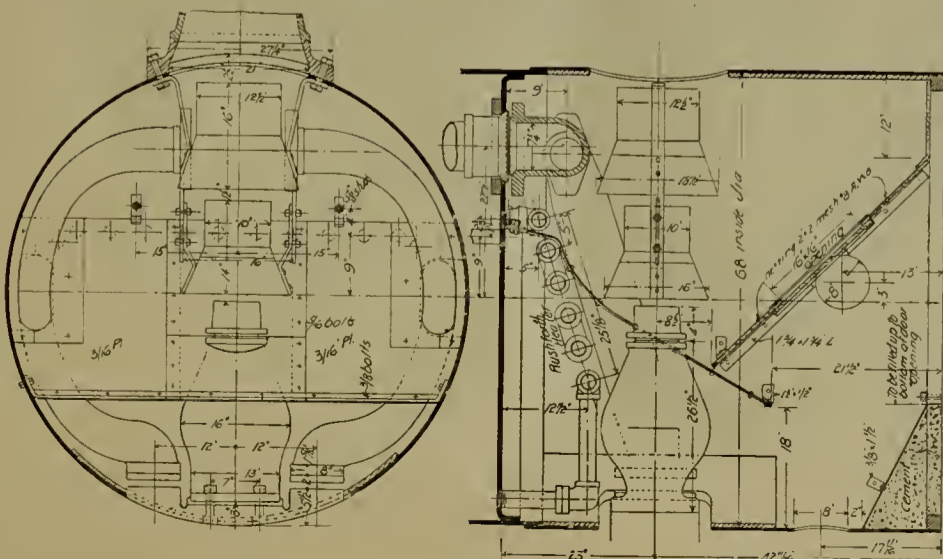

FIG. 4—FRONT END ARRANGEMENT A. T. & S. F. CONSOLIDATION.

Boiler, flue sheet front.....	11-16 in. thick
Boiler.....dome	31¼ in. dia., 24 in. high
Fire box, carbon steel.....	103x42 in.
Fire box, width at crown sheet.....	55 in.
Fire box, crown sheet.....	9-16 in.
Fire box, side and back sheet.....	¾ in.
Fire box, flue sheet.....	9-16 in.
Fire box, water space all sides.....	4 in.

## HEATING SURFACE.

Heating surface, fire box.....	165 sq. ft.
Heating surface, flues.....	1,740 sq. ft.
Heating surface, total.....	1,905 sq. ft.
Grate area.....	29.23 sq. ft.

## MISCELLANEOUS.

Stay bolts, Laurel double refined iron.....	1 in. dia.
Stay bolts, 1¼ in. hollow, ¾ in. hole, in 3d, 4th and 5th rows, sides and back.....	
Throttle and dry pipe.....	7 in. dia.
Safety valves, 3 Crosby pop., 3 in. dia., set at 180 lbs. and 182 lbs.....	
Guides, Laird two bar type, 6½ in. top, 4½ in. bottom	
Cross heads.....	cast steel, comp sition bearings
Wrist pin.....	4½ in. dia. by 3¼ in. long
Frames.....	cast steel, front frame, hammered iron

## TENDER.

Tender 24-wheel trucks, Player cast steel frames and holsters.....	
Wheels, steel tired.....	33 in. dia.
60,000 lbs. M. C. B. axles hammered iron, journals 4¼x8 in.....	
Tank A. T. & S. F. design, steel, capacity 50,000 gallons.....	

On these engines the following appliances are used: American Westinghouse driver brakes; Westinghouse improved automatic for tender and train; 9½ inch air pump; Ross Meehan driver brake shoes; Nathan injectors No. 9 and No. 10, 200 lb. pressure, 88 pattern; Nathan No. 9 cylinder lubricator, triple sight feed; Houston sand devices.

## COMMUNICATIONS.

## Long Stroke Cylinders.

To the Editor of The Railway Master Mechanic:

I note that in your last issue, in describing the Brooks mastodons for the Great Northern Railway, you say that a 34" stroke is the longest that you have ever known to be used in locomotive practice. Permit me to say that the Camden & Amboy R. R. had express locomotives running for years some with 36" and some with 38" stroke. These engines were built over forty years ago.

Observer.

[Our correspondent is, in the main, correct; but we trust that he will forgive the lapse of memory concerning a detail dating back forty years. We present some interesting statements from Mr. Geo. Cushing on this subject of long cylinder strokes, in another column. The Camden & Amboy engines were, according to his data, built some fifty years ago, and their cylinders were 34" stroke and 38" stroke, instead of 36" and 38", as Observer has it. A really better criticism comes from Mr. Cushing, who refers to 36" stroke engines on the Southern Pacific as late as 1886.—Ed.]

## The Title of Master Car Builder.

To the Editor of the Railway Master Mechanic:

In this so called age of improvement, when the tendency is to specialize all classes of mechanical work, that men may become more proficient in the several branches, is it not strange that the railroads should furnish almost the only exception to this rule, in consolidating their locomotive and car departments, between which there are no points of similarity except in the name "mechanical."

It is possible that merging the two departments into one, under a superintendent of motive power, is more satisfactory to the management of our roads, and undoubtedly is, judging from the large number of roads so operated; but is that any reason why the head of one department should be deprived of his title, while that of the other remains the same? Why should the title of Master Car Builder be abolished? Is not a man a master car builder who has devoted the better part of his life to acquiring the information necessary to design and construct cars? Is he not still a master of his trade and cannot he report to a Superintendent of Motive Power under that title as well as under that of General Foreman? His services are still required and, aside from the office work, his duties are the same as they ever were.

Why not abolish the title of Master Mechanic? Does this title imply any more prominent position or superior ability? We have Master Masons, Master Carpenters, Master Painters, Master Mechanics, and did have Master Car Builders, all supposed to be masters of their different trades and competent to take charge of their work; but for some unaccountable reason the fate of the Master Car Builder is sealed.

In some few instances, as General Foreman, he is still consulted regarding the construction of new equip-

ment but, in the majority of cases, this is not considered necessary, as he has left a sufficient number of samples of his work to furnish a foundation for any slight changes that may be considered necessary.

Where is there a modern car today, either passenger or freight, on which the principal improvements were not suggested or designed by a master car builder?

The Master Car Builders' Association has done more to benefit the railroads of this country than any other organization, and has made it possible to interchange cars from one side of the continent to the other. The Master Car Builders have recommended all of the recognized standards and formulated the rules of interchange, which have saved the railroads millions of dollars, but their work seems to have been accomplished, and hereafter they will live only in memory, and their grand association, conceived and carried out by them, will soon be a thing of the past.

Is it at all surprising that we are not educating any future master car builders? What inducements are the railroads offering to our young men to devote their time to car building? The prospect that at some future time they may become a General Foreman? Is it surprising that the young men desirous of securing a railroad education start in at the machine shop? In a few years, by proper attention to his work, he is made a Division Master Mechanic and placed in charge of both the locomotive and car work, although he has never spent one hour in a car shop. But he is in the line of promotion and in a few more years he will become Superintendent of Motive Power, and be in a position to dictate the designs for the car equipment best suited to the requirements of the road. Is it any wonder that mistakes sometimes occur?

What of the young man who, through a misunderstanding of the existing conditions, began work in the car department? By studious attention to his work he has become a master of his trade and has earned the title and distinction of a General Foreman. He has reached the top of the ladder. But, unfortunately, his ladder was short.

Both of these young men graduated from the same school and were regarded as equally intelligent; both have demonstrated their ability in their respective lines; but, owing solely to the present condition of affairs, one of them has secured a prominent position, while the other must be content to settle down on a small living salary or leave the business.

I will concede that all Master Mechanics cannot become Superintendents of Motive Power, neither can all the men in the operating department become General Managers. But the road is open, on either line, to these positions. Is it justice or even good business policy to close it to the car department?

In two notable instances railroad companies have evidently recognized the justice of these claims and offer a faint hope that others may follow their example.

Car Builder.

[Some comment upon the above is given in our editorial columns.—Ed.]

## What Constitutes "Rough Usage" in the Handling of Cars.

To the Editor of The Railway Master Mechanic:

As the time for the annual convention is approaching and the various railway clubs begin to take up the discussion of the rules of interchange, a question which should receive more than passing consideration is, "what constitutes rough usage in the handling of cars."

In several different articles in the rules of interchange, it is specified that damage caused by unfair usage is chargeable to the delivering company, and in Rule 3, articles 35 to 43, we find Combinations of Simultaneous Damage which define rough usage and which are evidently intended to cover this point, but as they refer principally to the sills and draft gear, the question naturally arises, can we consider a car as having received unfair usage when any of the specified combinations do not exist? A large number of car men answer no; and in support of their claim, say there is not an article in the rules allowing an inspector to determine any damage as rough usage, where one of the combinations, specified in Rule 3, articles 35 to 43, does not exist.

All roads concede the point of making the handling road responsible for cornering or raking the side of a car, under the open question of accident, but should not the same responsibility occur in breaking in the end of a car, although Rule 3, article 43, makes the owner responsible for any damage to the end of the car, if not more than two end or two corner posts, or one end, and one corner post is broken at the same end of car; in other words, the rules allow a handling road to destroy the entire end frame of a car, between the end sill and end plate, if one of the corner posts is not broken, as none of our cars have more than two end posts at one end of the car.

I think a solution of this point was offered at the convention last year, by one of the western members, but did not receive any consideration; he proposed to substitute for Article 43, Rule 3, one making the owner responsible for any damage to the upper frame of the car occurring from causes inside the car, and

the handling road responsible for any damage occurring from outside causes. This seems to be the most reasonable way out of the difficulty and places the responsibility where it belongs.

If the upper frame of a car is not properly constructed so as to withstand the pressure or shifting of the load, the owner should be held responsible for any damage from this cause; while on the other hand, no damage can occur to the upper frame of the car from outside causes by any ordinary or fair usage of the car. This was undoubtedly the intention of the framers of the rules in adding article 43 to the list of combinations of simultaneous damage defining rough usage, but they should have specified how the damage must occur.

It does not seem reasonable that any company would claim the right, under the rules, to back an overhanging load into the end of a box car, breaking in both end posts, siding and lining, and then billing the owner for the repairs; but it is done repeatedly by different companies; and, apparently, the rules uphold them.

Another article which should be inserted in the rules, should specify that there can be no division of responsibility in any accident damage; for according to my idea the road handling the car is either responsible for all or none of the damage occurring.

On many roads it is the usual practice to assume the cost of repairs to such parts as enter into one or more of the various combinations specified in Rule 3, articles 35 to 43, and bill the owners for the cost of all other parts not specified in these combinations, although the rules distinctly specify that the handling road is responsible for any damage caused by unfair usage.

It is of course impossible to frame a set of rules that men, when so inclined, will not evade, but we can make the wording of them so clear, especially in the cases specified, that they cannot refer to them as authority for holding their position.

H. M. Perry.

## SOME NOTES ON LOCOMOTIVE STEAM GAGES.

BY THEO. H. CURTIS.

All engineers and firemen depend daily on the steam gage on the boiler head to know the pressure in the boiler, and they are aware that the gage gets out of order. The engineer, knowing that the engine is not pulling what she should, and thinking that the gage shows more pressure than is actually on the boiler, reports the gage. The reported gage is taken off, taken to the test gage, and found to be out a little or none. Yet the engineer was correct in thinking the gage to be incorrect, even when the test gage did not locate the trouble.

It is possible, owing to the location of the gage, to have it in error from one to twenty pounds, and even more in extreme cases, and yet have the gage show correct every time it is tested with the test-gage. And even if a new gage, correct with the test-gage, be applied, under certain conditions, it will be in error in indicating the pressure.

Most steam gages have something in the form of a horse shoe inside, and this horse shoe is a hollow tube. The pressure in the tube tends to make the horse shoe open further between its two ends. Light connections are fastened to these two ends and a steam gage hand is attached whereby the opening and closing of the ends of the horse shoe tube cause the hand to turn around. The hand shows on the gage dial the number of pounds pressure that causes it to move. There are also forms of gages other than those having the hollow horse shoe tube. Some have a diaphragm which is caused to move by the different pressures that are applied, and a suitable mechanism is applied to transmit the movement of the diaphragm to the steam gage hand.

Steam gages are adjusted cold. The fine mechanism is adjusted to resist certain pressures and correctly indicate the same when all parts are at a certain temperature. Almost every one's general experience has taught that metal becomes weaker as it gets warmer—say from fifty degrees upward. Accordingly if a gage be adjusted and tested with the cold test-gage at sixty degrees temperature, and then put onto a hot boiler where the gage is at one hundred degrees or more temperature, the fine hollow tube will open more with the same pressure, than it would when cold. The greater the pressure the more the horse shoe tube will open, and if the tube be weakened by heat the same pressure will make the hot gage show more pounds on the dial than would a cold gage.

In order to keep the steam from the working parts of the gage and thereby keep the gage cool, a water column is used, called a syphon, wherein the steam condenses. This syphon pipe extends above the gage, around it, or in a coil, and retains the cool water for the working parts of the gage.

For an experiment, shut off the gage from the

boiler (the boiler having a known pressure), let the water out of the water column, make all connections tight, and then turn on the steam. If there is eighty pounds pressure in the boiler, the steam entering the gage and heating all parts will cause the gage to indicate much in excess of the actual pressure of eighty pounds. As the water fills the column and the inside parts of the gage cool, the hand will gradually move back to the correct indication. If a connection in the gage leaks and lets the water out of the hollow tube, the steam getting into the tube will cause the hand to show a greater pressure than is in the boiler.

A very deceptive thing about a hot gage is this: If the gage is too near the boiler, the great heat from the boiler will heat all parts of the gage, including the water column, and cause the gage to indicate much greater pressure than is in the boiler. Take this very gage to the cool test-gage and it will show correct indication. Remember that the gage gets cool before it is tested with the test-gage; therefore it will show correctly. If the test-gage is hot it will also be incorrect.

Unless a second gage be applied to the boiler, and this second gage be kept cool, it is not likely that the engineer or fireman will ever know how much the hot gage is in error. If a safety valve that is set at a known pressure is applied, the error in the gage may be detected by the popping of the valve. If the steam gage is too hot to bear the bare hand on any part with ease, it should be moved to a cooler place. Sometimes by placing small pieces of wood between the gage and the stand, thereby allowing the air to circulate and keep the gage cool, matters may be greatly helped.

The freezing of water in the gage will strain the fine parts, thereby causing the gage to be incorrect when water under pressure is applied.

Short water columns are not as sure to give correct results as long ones. The column should always extend above the top of the gage. This will ensure the application of water to the gage, if the connections are tight.

The steam gage pipe should always be connected direct to the boiler. If it be connected to the boiler head fountain, the steam turret, or any device that has a number of boiler head fittings attached, it will be governed by the pressure in this fountain. When both injectors are working, they taking steam from the fountain, there will be several pounds pressure less in the fountain than in the boiler. This may be detected by noting the boiler pressure when both injectors are working, and then shutting off both injectors at once and noting the instantaneous rise of pressure by the gage indication. While the boiler pressure may rise after shutting off both injectors, it rises gradually and not instantaneously.

**CYLINDERS AND VALVES OF THE GREAT NORTHERN MASTODON.**

In our last issue we gave full description and illustration of the Great Northern 21x34-in. mastodon built by the Brooks Locomotive Works. We now give a perspective of the cylinder casting for this engine, sectional view of valve, cylinder and piston, and some detail of the piston valve packing rings. The drawings quite fully explain themselves. The piston valves and packing rings have no other means of adjustment than that due to the spring of the metal, which provides for a wear of about 1/8" in diameter. The builders have found in practice, however, the wear on these rings is remarkably slight, so that renewals of packing rings are very seldom required. The clearance space is considerably reduced in this engine by the use of the piston valve, and this was in fact one of the objects for which this valve was used. The piston rod, it will be noted, has an extension forward through the front cylinder head, presumably for stiffness and to guide the piston, but the piston is seven inches thick and there are pistons equal in diameter to this one and not so thick which are running without the extended piston rod.

This engine we may add made a notable performance while being tested at St. Paul. The test was made on St. Paul hill which has a grade of 87 feet to the mile, combined with a four degree curve. Up this grade the engine hauled 32 loaded cars, weighing 1,070 tons, the mean effective pressure in the cylinder while doing this work being 189.5 lbs., or about 95 per cent of the maximum boiler pressure used during the test, the pop valves being set at the time at 200 pounds.

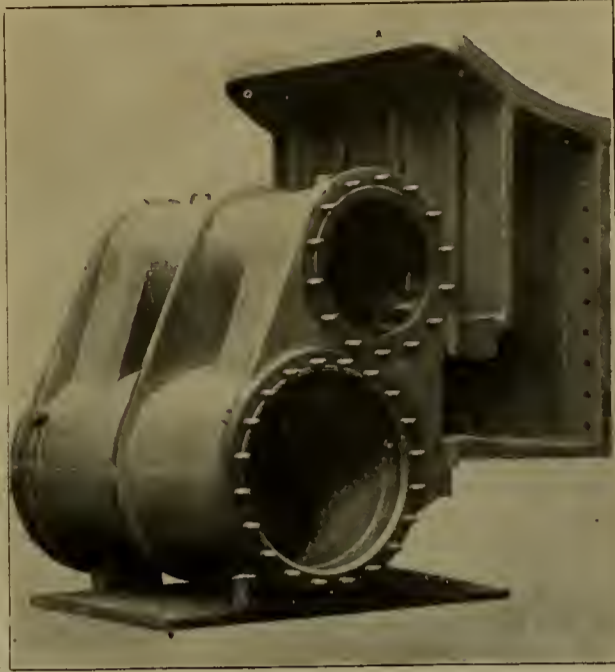

CYLINDER CASTING.

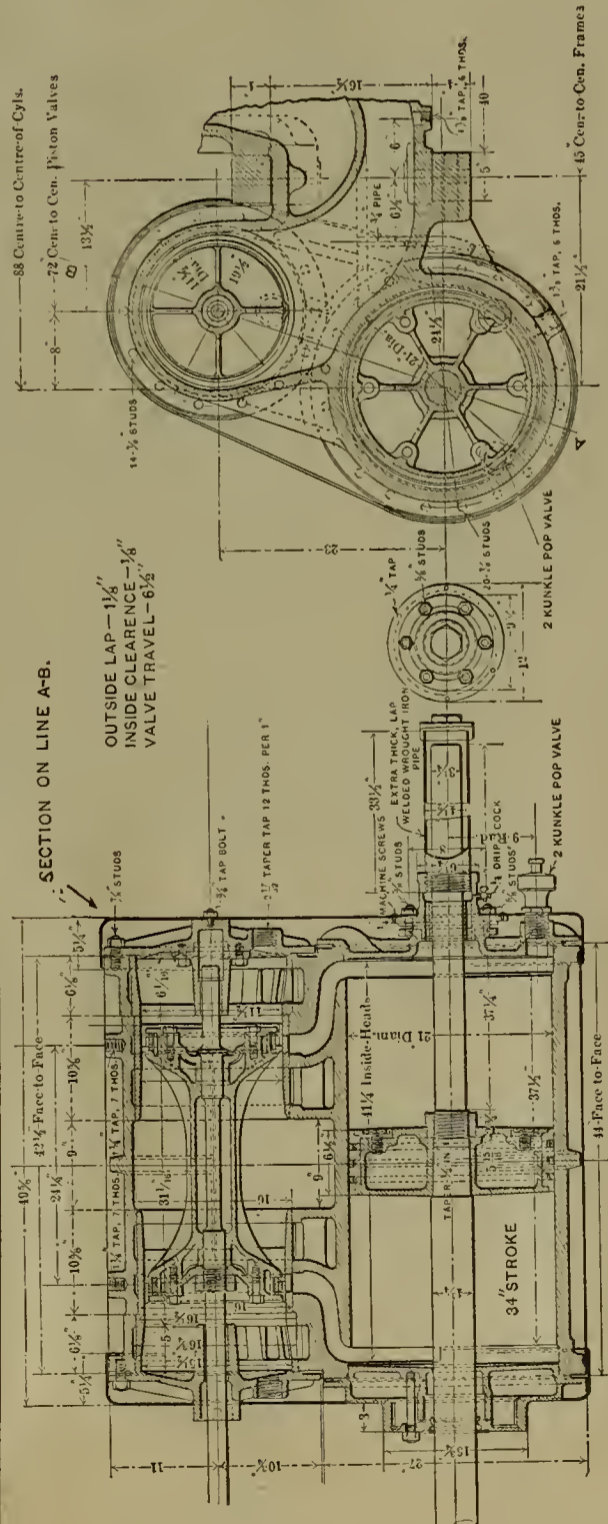
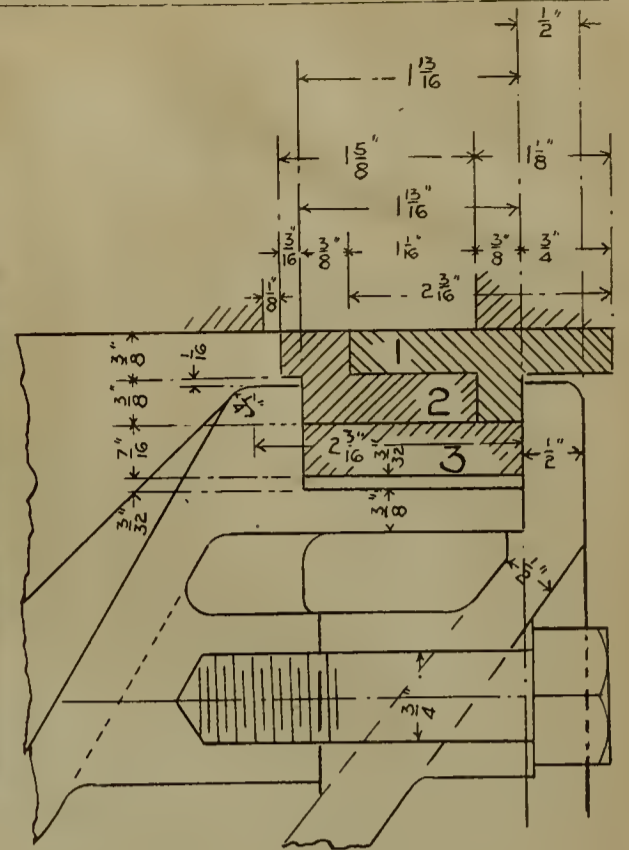

VALVE, CYLINDER AND PISTON.

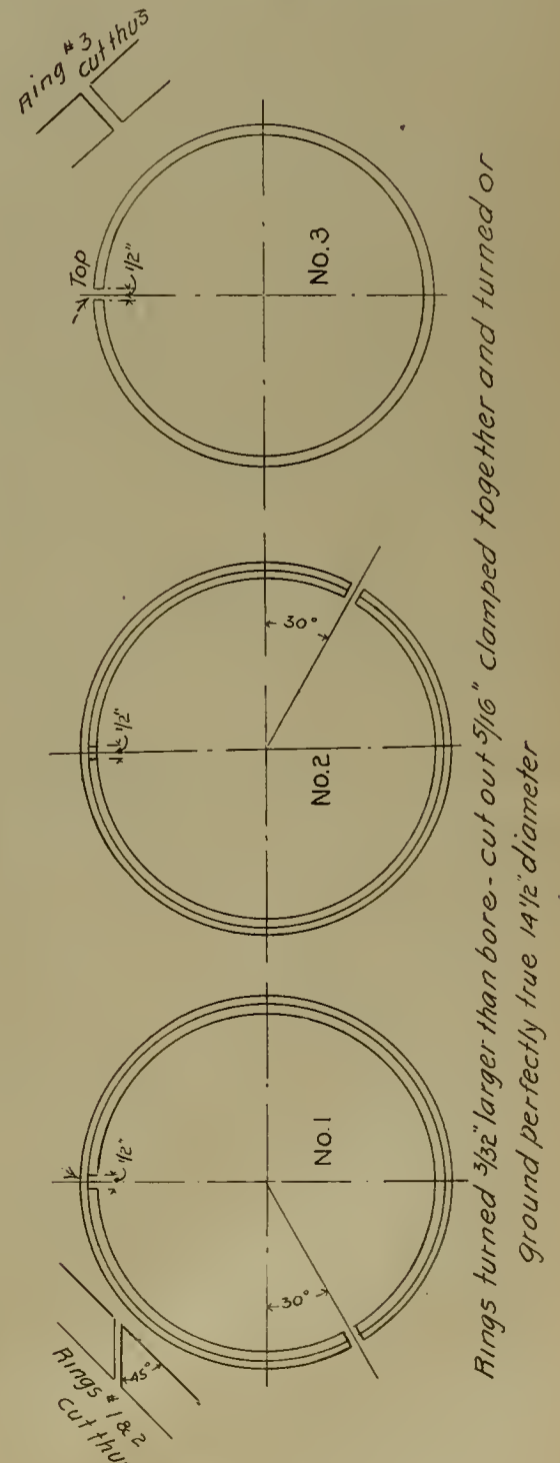

PISTON VALVE PACKING RINGS.

## PAINT TESTS.

Our readers will remember that in our issue of September, 1897, page 135, we gave a paper on paint tests, presented by Mr. Max Toltz\* before the Civil Engineers' Society of St. Paul. At a subsequent meeting Mr. W. J. Wilgus presented a written discussion upon this paper and this discussion we append:

As the results of my own experiments and observations differ somewhat from those of Mr. Toltz, I deem that the following remarks may be appropriate:

Mr. Toltz's recommendations, briefly stated, are as follows:

- 1st. Priming coat of linseed oil.
- 2d. Coat of asphaltic varnish.
- 3d. Coat of graphite paint.

The use of a priming coat of linseed oil is discounted by many engineers as tending to act as a "catch-all" for grit, dirt, etc., which are embalmel in the oil as it hardens, and are never perfectly removed. There is, however, the more serious objection pointed out by Mr. J. Spenrath, in his prize essay on "Protective Coverings for Iron," published in the Railroad Car Journal, that linseed oil, without a pigment, never thoroughly hardens, and ultimately blisters the succeeding coatings of paint. In the writer's opinion, the preferable method is to enforce rigidly that clause in our specifications which provides that the surface of the steel shall be thoroughly cleaned by the sand blast or other approved method before the application of the priming coats at the shop, even if the manufacturer must be paid an additional price for so doing.

The use of asphaltic varnish for the first coat of paint is, from my observation, inferior to that of a heavy coat of red lead and oil applied to a clean, dry surface. The assertion of Mr. Toltz that many progressive engineers are discarding the use of red lead is, I consider, unsupported by facts. Mr. Walter Berg, Principal Assistant Engineer Lehigh Valley Railroad, has made a careful, exhaustive, and intelligent research into the merits of various paints for railroad bridges, and, in an article published about a year ago, he states that replies to inquiries as to the prevailing practice on about 30 prominent railways show that over 80 per cent. recommended using red lead and oil for priming coats. Moreover, as a result of his extensive study of the problem, he indorses that practice. Spenrath holds that the sole weakness of red lead lies in its being attacked by hydric-sulphide, but with a suitable second and third coat of paint this objection is of little weight. Neither does Mr. Toltz produce any evidence supporting his adverse opinion of red lead and oil.

At the last annual meeting of the Master Car and Locomotive Painters' Association the preponderance of evidence submitted by various members went to prove that red lead and oil, as a protective coating for the metal parts of cars and trucks, is unsurpassed. Mr. Toltz remarks that the fact that advocates of red lead and oil had begun to add carbon black and graphite to their paint is a sure indication of their own disbelief in red lead alone as the best pigment. This remark seems to have as much weight as the one to the effect that the engineer using salt for mixing mortar in freezing weather really doubts the value of cement as a binding material. Lampblack and graphite are often used with red lead and oil, not necessarily to improve the lasting qualities of the pigment, but to make the paint work smoothly and evenly. Their use certainly in no way reflects upon the basic material as a preservative.

The experiments and examinations of various paints in actual use by the writer, confirm the above conclusions. Tests made by covering clean, bright steel plates with two coats of 12 different paints, and submerging them for two weeks in water containing one-half ounce of hydrochloric acid to one gallon of water, disclosed the fact that the relative merits of the paints thus tested were as follows:

- 1st. Red lead and linseed oil.
- 2d. Asphaltic varnish (pure, genuine) paints.
- 3d. Carbonizing paints.
- 4th. Graphite paints.
- 5th. Iron oxide paints.
- 6th. Cheap patent paints.

These tests gave excellent comparative results, as they emphasized the value of the three cardinal virtues of a good paint:

- (a) Good adhesion to the metal.
- (b) Lack of porosity.
- (c) Resistance to chemical and galvanic action.

The absence of any one of these three qualities, even if the other exist, will cause the paint to fail.

Observations of paint on many steel bridges confirm the conclusions above stated.

The color of red lead is of course objectionable, and for second and third coats the use of asphaltic varnish paint is to be recommended. During the past four

\*It will be remembered that Mr. P. H. Conradson wrote to us after the appearance of Mr. Toltz's paper setting out that the paper in question was an almost verbatim transcript of a report made by him to the management of the Great Northern Railway. See Railway Master Mechanic for October, 1897, page 146.—Ed.

years the majority of the new bridges on the Rome, Watertown and Ogdensburg Railroad, which were originally coated with cheap patent paints, have been repainted with a paint prepared from a formula given by Dr. C. B. Dudley, as follows:

- 4 pounds of pure lampblack ground in raw linseed oil.
- $\frac{7}{8}$  gallon genuine asphaltic varnish.
- $\frac{1}{4}$  gallon pure, refined, boiled linseed oil.
- $\frac{1}{4}$  gallon drying japan.

These ingredients were purchased and mixed by the railroad company, and cost from 60 to 80 cents per gallon. One gallon covered about 350 square feet, and the cost of cleaning the surfaces and applying one coat of paint cost, on an average, 60 cents per net ton of bridge material.

The results from the use of this paint have so far been excellent.

To summarize, the experience of the writer has led him to favor the following practice:

## For New Work.

1st. Thoroughly clean the surface with the sand blast and apply, at the shops, a priming coat of red lead and linseed oil and a second coat of asphaltic varnish, using special care where surfaces come in contact and are shop-riveted, or at parts that are inaccessible for field painting.

2d. Apply a third coat of asphaltic varnish paint, after erection.

## Repainting Bridges.

If in bad condition, clean all surfaces with the sand blast and use a priming coat of red lead and oil, and a succeeding coat of asphaltic varnish, as specified for new work. In exposed places a third coat of asphaltic varnish should be used.

If the old paint is in fair condition, clean all surfaces from dirt, dust, scale, etc., and, after touching up all bare or defective spots with a preliminary coat of asphaltic varnish paint, apply one coat of the same paint.

The company should purchase and mix all ingredients of the paint to be used, taking great care to obtain only the pure, unadulterated articles. The majority of the patent paints that flood the market simply disguise, under euphonious titles, a conglomeration of worthless materials.

The importance of this subject, treating as it does of the armor that is the sole protection of our "permanent" steel bridges against the ravages of their mortal enemy, rust, is my apology for thus encroaching on your time and good nature.

## THE NATIONAL ASSOCIATION OF MANUFACTURERS.

There have been many inquiries made concerning the National Association of Manufacturers, what it is and what it does, its objects, etc. It is an association which we believe is destined to be of great value to the business interests of this country. It was organized in January, 1895, has had a rapid and healthful growth and has developed into a powerful organization embracing in its membership upwards of one thousand of the largest manufacturing interests in this country, representing every important industry and every prominent industrial center.

The work of the National Association of Manufacturers naturally falls into groups—that which pertains to the home interests of the manufacturers of the United States, and that which relates to American trade with foreign countries. Among those objects which pertain to home interests are these:

- The conservation of the home market.
- The creation of a federal department of commerce and industry.
- The improvement of patent laws.
- The unification of railroad freight classification.
- The enactment of a uniform bankruptcy law.
- The improvement of internal waterways.

Although entirely without the pale of politics and embracing in its membership men of widely differing and pronounced political views, the National Association of Manufacturers stands for the protection of American industries, believing that there is no market in the world of such importance to the manufacturers of the United States as that which lies within their own country.

The tariff is viewed by the association, however, as a business problem, not as a matter of political capital; and the adjustment of the rates of duty in such a manner as to equalize the cost of imported articles and goods made in the United States represents the view of the tariff problem as held by the majority of the members of the association.

No feature of the home work of the association has met with more favor than the part that it has taken in the movement for the creation of a Federal Department of Commerce and Industry. Through the efforts of a strong committee of its members, and by the circulation of a large amount of printed matter relating to the subject, the association has done its full share in keeping alive public interest

in the matter, and in making the advantages of the proposed department more widely and better understood.

The consideration of needed reforms in patent laws and in the practice of the Patent Office comes naturally into the programme of the association; for no interests are touched more closely by the operation of the patent system than the manufacturers of this country. A committee of members of the association has been making some careful investigations along this line, and a large amount of valuable material has been compiled, as one of the first steps in the work.

The work which the National Association of Manufacturers has been doing in the extension of the foreign trade of American manufacturers has attracted a great deal of attention both at home and abroad. The chief features embraced by this work are:

- Investigation of foreign markets.
- Establishment of sample warehouses.
- Improvement of the consular service.
- Restoration of the American merchant marine.
- Restoration of treaties of reciprocity.

In this work as in all else undertaken by the association, the aim is to apply practical business methods. The plans for the foreign work of the association provide for the careful investigation of possible new markets for American products, the study of trade conditions in various countries, and the ascertainment as fully as possible of the classes of American goods salable in different markets, with the conditions of competition which must be met.

This work is preliminary and preparatory to larger undertakings in the way of establishing depots under the management of the association in such foreign trade centres as seem to offer the best opportunities for the development of larger trade. These agencies are designed to be ware-rooms for the display of American merchandise of every description under conditions that will secure the most favorable attention of the possible purchaser.

It is believed by the management of the National Association of Manufacturers that this plan can be applied with excellent results in many foreign countries, particularly in the Latin-American trade centres. Investigations with this end in view are being conducted in several countries and the first warehouse in the system has been established in Caracas, Venezuela, under particularly favorable conditions, created by a special concession from the Venezuelan government.

A series of such establishments, covering all the important trade centres abroad, will strengthen American trade interests in foreign markets to an extent that can hardly be estimated. Every such establishment will be a source of live information about foreign markets and about American goods which will be at the disposal of the foreign merchant who wishes to buy, and the American manufacturer who is seeking to sell.

This plan of promoting foreign trade has received the hearty approval and support of the foreign governments that have been approached, and the merchants in foreign countries have offered their cooperation in a practical manner.

An important feature of the work of the National Association of Manufacturers is the publication of a large amount of matter that is of general interest and value to manufacturers. The circulars of information issued by the Bureau of Publicity of the association have rendered valuable aid in promoting the interests of the organization. The circulars are distributed gratuitously among the manufacturers of the United States and to many foreign business houses.

The association publishes a small fortnightly paper, entitled "American Trade," which conveys to its readers much information about the commerce of the world and the part which the merchants and manufacturers of the United States have therein.

The Bureau of Information which is conducted for the benefit of the members of the association, possesses a great amount of material regarding the trade of the world which is placed freely at the disposal of the members. Special inquiries concerning any line of business are undertaken for members when desired. Information concerning the financial standing and general responsibility of foreign merchants is furnished without charge. There are numerous other services which are performed for members of the association, any one of which is a good dividend upon an investment in membership.



An annual fee of \$50 entitles a manufacturer to membership and to all the privileges incident thereto during the period of twelve months from the date of payment. Only manufacturers are eligible for membership.

The general officers of the National Association of Manufacturers are as follows: President, Theodore C. Search, Philadelphia, Pa., (Treasurer John B. Stetson Co.); Treasurer, Robert Laidlaw, Cincinnati, O., (President Laidlaw-Dunn-Gordon Co.); Secretary, E. P. Wilson, Cincinnati, O. (Room A, Chamber of Commerce.)

#### A NEW FISH PLATE PUNCH.

One of the latest designs of fish plate punches, turned out by the Hilles & Jones Co., of Wilmington, Del., is shown in quite full detail in our illustration. This punch has a capacity for punching six oval holes  $1\frac{1}{2} \times 1$  inch through 1 inch thickness of steel. The punches and dies are adjustable center to center, the extreme distance of the end punches being 42 inches. The arrangement of the clutches, punches, dies, etc., is very complete. Mo-

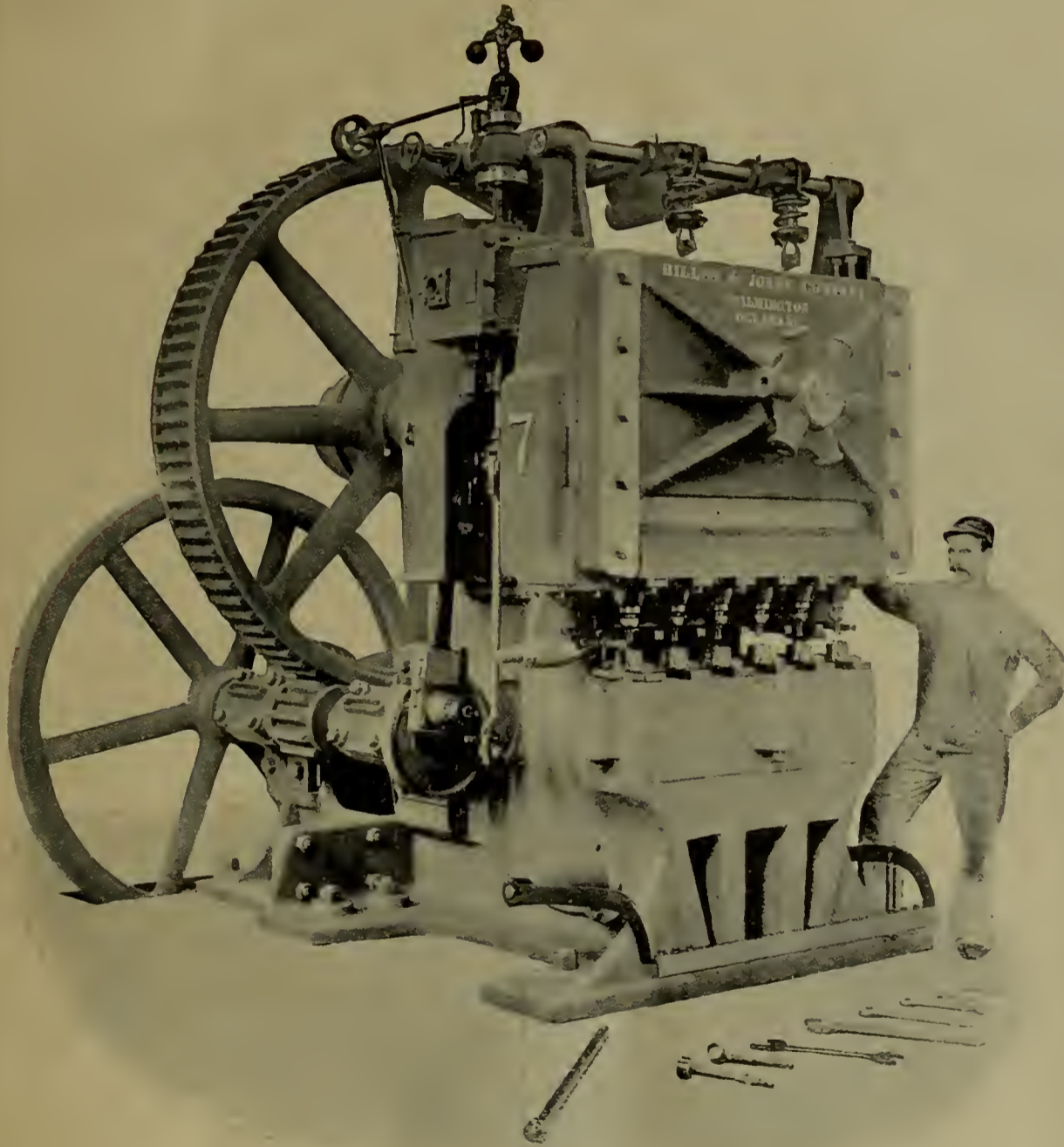

A NEW FISH PLATE PUNCH.

tive power is furnished by a self-contained heavy engine mounted on the frame of the machine, driving direct on to the fly-wheel shaft. There is an improved automatic stop which brings the sliding head to rest at any desired point in the stroke. This arrangement makes the working of the machine very light upon the operator, and the extension of the foot lever across the front also facilitates the handling of the tool. The sliding head is counter-balanced through two spiral springs to take the shock of punching. Spur wheel and pinion each have turned shrouds to the pitch line, and the clutches are faced with steel; the punch holders and die blocks are of cast steel. The engine is complete with governor, throttle valve, tallow cup oilers, etc. The whole machine is complete on one foundation, with every detail carefully looked after, and is be-

lieved to be the most substantial machine of its type which has been gotten up.

#### SOME NOTABLE CAR WHEEL TESTS.

A series of tests on railway wheels and axles of special quality was made January 21 at Buffalo, N. Y., by the New York Car Wheel Works and the P. H. Griffin Machine Works under the auspices of the Central Railway Club and in the presence of about one hundred railway officials from the middle and eastern states and Canada. Representatives of the leading railway papers of the country were also present.

The tests were made under the supervision of the committee appointed by the Central Railway Club at its November meeting, the committee consisting of Mr. A. C. Robson, Division Master Car Builder of the Lake Shore & Michigan Southern Railway, Mr. J. A. Bradley, General Foreman Car Department of the New York, Chicago & St. Louis Railway, and Mr. Robert Potts, Division Master Car Builder of the Michigan Central Railway, St. Thomas, Ont.

tally on heavy iron and stone foundation. Tapering steel wedge placed in bore. Weight of 475 pounds dropped from varying heights, commencing at one and half meters (about 5 feet), and increasing by half meters to four meters (about 13 feet). Wheel must stand six blows in succession without bursting. Test to be continued until wheel is broken.

French State Railway Test.—Wheel placed upright on heavy iron and stone foundation. Weight of 2,200 lbs. dropped from a height of four and a half meters (about  $14\frac{1}{2}$  feet). Wheel must stand three blows without breaking. Test to be continued until wheel is broken.

Tests required by American Railways for Cast Iron Wheels.

Master Car Builders' Test.—Wheel placed horizontally on heavy iron and stone foundation. Weight of 140 lbs. dropped from a height of twelve feet on hub. Required to stand five blows.\* Test to be continued until wheel is broken.

Pennsylvania Railroad Thermal Test.—Wheel laid flange down in the sand and a channel-way an inch and a half wide and four inches deep moulded with green sand around the wheel. This channel-way will then be filled with molten cast iron; two minutes later an examination of the plates will be made. Wheel to be accepted, must not be broken in pieces, and the cracks in the plate, if any, must not extend through the tread.

Bursting Tests.—An axle having wheel seat turned with offsets increasing by one sixty-fourth of an inch, will be forced into the bore of a wheel by the hydraulic press. There will be five offsets which will increase the diameter of the wheel seat by  $\frac{5}{64}$  inches over diameter of wheel bore, and pressure will be recorded for each offset. Test will be continued until wheel breaks.

Tests on Axles of Standard and Special Qualities.

Test No. 1.—The ends of a cold rolled axle will be supported, and pressure brought to bear at the center to bend it out of line and it will then be allowed to spring back. The pressure for each deflection and the permanent set, if any, will be recorded.

Test No. 2.—Same as test No. 1 on ordinary steel axle of the same diameter, and Master Car Builders' specification.

Test No. 3.—A 4" cold rolled axle, 6 ft. 5 in. in length, of the special quality furnished for electric service will be bent cold in the hydraulic press until the ends are brought together. An examination will then be made to see if any cracks appear at the bend.

Note—All of the wheels tested will be made of special mixtures of iron, and of the weights and diameters recommended by us for use under locomotive passenger cars and 100,000 lb. capacity freight cars.

#### RESULTS OF CAR WHEEL TESTS.

The results of the tests were as follows:

Austrian State Railway Test, applied to 38-inch wheel, weighing 860 lbs. Wheel to stand eight blows.—1st to 9th blow. No effect.

At ninth blow small crack in tread four inches long, gradually extending to twelve inches at twelfth blow. 13th to 18th blow. No change.

16th to 21st blow. Crack extended to plates. 21st blow. Crack extended through both plates around hub to tread on opposite side.

22nd blow. Wheel broke into two pieces. Chill. Five-eighths and three-quarters inch.

Austrian State Railway test applied to thirty-three-inch wheel, weighing 650 pounds, Pittsburg, Bessemer and Lake Erie specifications for 100,000 pounds capacity cars.—

1st to 7th blow. No effect. 7th to 15th blows. Small cracks developing and extending through tread and plates.

16th blow. Wheel broke into two pieces. Chill. Nine-sixteenths and ten-sixteenths inch.

Under the Austrian State Railway test the wheel was required to stand eight blows in all without being broken in pieces. It will be seen that in the first test given above the wheel stood eight blows without the slightest effect.

German Railway test applied to 33-inch wheel, weighing 650 lbs. Master Car Builders' specifications for American railways.—

1st to 14th blow. No effect. 14th to 16th blow. Crack extended through hub and plate.

16th blow. Wheel broken into two pieces.

On this test the wheel is required to stand six blows in succession before being broken into pieces, and the wheel tested stood thirteen blows with no effect whatever.

French State Railway test applied to 33-inch, 650 lbs., wheel. Lake Shore & Michigan Southern Railway specifications for locomotive tenders. Wheel must stand three blows.—

1st to 6th blow. No effect. 6th blow. Crack eight inches long in throat, parallel to flange. Crack through rim of wheel at bottom to single plate. Wheel unbroken and test discontinued.

Belgian State Railway test applied to 39-inch wheel. Weight 900 pounds. Grand Central Railway of Belgium specifications. Wheel must stand three blows.—

1st to 7th blow. No effect. 8th blow. Wheel broken into two pieces.

\*Pennsylvania Railroad requires twelve blows. Lehigh Valley Railroad requires nine blows.

The details of the tests were set forth in the printed announcement as follows:

In making these tests, chilled wheels of special quality and design will be submitted to the tests required in the different European countries for steel wheels, with the intention of demonstrating the comparative value of steel tired, and special quality chilled iron wheels for high grade service.

Tests required under the specifications of the leading European railways for steel wheels.

Austrian Railway Test.—Wheel placed upright on heavy iron and stone foundation. Weight of 475 pounds dropped from varying heights, commencing at one meter (about  $3\frac{1}{4}$  feet), and increasing by half meters to six meters (about  $19\frac{1}{2}$  feet). Wheel must stand eight blows in all. Test will be continued until wheel is broken.

German State Railway Test.—Wheel placed horizon-

Chill. Eleven-sixteenths and three-quarters inches. Master Car Builders' test on 33-inch wheel. Weight 600 pounds. Master Car Builders' specifications: Wheel must stand five blows.—

1st to 26th blow. No effect.  
27th blow. Small crack in bottom plate.  
28th blow. Crack extended to a length of eight inches.  
28th to 47th blow. No change.  
48th blow. Crack through flange.  
49th to 85th blow. Cracks gradually extending.  
86th blow. Wheel broken into two pieces.

Chill. Nine-sixteenths and five-eighths inch. Pennsylvania Railroad Thermal test applied to 32-inch wheel, weighing 600 pounds. Pennsylvania Railway specifications.—

The molten band one inch and a half wide and four inches deep was cast in fourteen seconds, and the wheel stood the test without failure of any kind.

#### Bursting test.—

An axle with five offsets was forced to the maximum pressure of a hundred-ton hydraulic press, into the bore of a thirty-three-inch 650 pounds, Pittsburg, Bessemer & Lake Erie wheel, with no effect on the wheel. The axle at its largest diameter was five-sixty-fourths of an inch larger than the bore of the wheel into which it was pressed.

#### TEST OF AXLES OF STANDARD AND SPECIAL QUALITY.

Special cold-rolled steel axle, three and three-eighths inches diameter, resting on supports six feet six inches apart, was pressed out of line one-quarter of an inch and allowed to spring back. No effect. It was then pressed out of line one-half inch and pressure released. No permanent set. It was then pressed out of line three-quarters of an inch and pressure released. No permanent set. It was then pressed out of line one inch and pressure released. Permanent set one-eighth of an inch.

The result of this test showed that a special axle would withstand a blow that would bend it three-quarters of an inch, without the slightest effect in the way of a permanent set or bending.

A similar test was then applied to a standard steel axle, Master Car Builders' specifications, for fifty thousand pounds capacity cars, diameter four and a half inches in center at smallest point. The axle was pressed out of line one-quarter of an inch and allowed to spring back. No effect. It was then pressed out of line one-half inch and allowed to spring back. Permanent set one-sixteenth of an inch. It was then pressed out of line three-quarters of an inch and pressure released. Permanent set one-eighth of an inch. It was then pressed out of line one inch and pressure released. Permanent set five-eighths of an inch.

Another test then followed with a special quality cold-rolled axle which was bent one inch out of the straight line in the center and pressure released. The permanent deflection was one-sixteenth of an inch.

The test of a special quality cold-rolled axle, four inches in diameter, six feet five inches long, then followed. This axle was bent cold under the hydraulic press until the ends were brought together. No defects of any kind appeared. The special feature of this test was that it was made on exactly the same quality axle as were subjected to the tests for bending and deflection, indicating that the strength and toughness were equal to the elasticity of the axle. A sample of a similar quality axle was exhibited which had made a mileage of 120,000 miles with less than one-thirty-second of an inch wear.

In addition to the tests referred to, the P. H. Griffin Machine Works and the New York Car Wheel Works were thrown open throughout to the visiting officials, and the process of manufacturing and finishing wheels was inspected in every detail from the smelting of the iron to the completion of the finished work. The methods followed by the New York Car Wheel Works in their daily manufacture whereby the quality of every wheel is positively assured before delivery for service were also explained.

The members of the club and visitors all expressed themselves as highly gratified and interested in the results and the staff of the New York Car Wheel Works and the P. H. Griffin Machine Works were more than pleased with the same. When it is considered that the test on car wheels used in America consists of dropping a weight of one hundred and forty pounds from a height of twelve feet from five to eight times, as proving the value of wheels to be accepted for service, as compared with tests made with weights from five hundred to two thousand pounds dropped from heights up to twenty feet, it will be plainly seen how much more severe the latter tests are. It must of course be understood that the European tests are intended for steel-tired wheels only, and in erecting the necessary testing machinery and subjecting chilled wheels to such severe tests it was the intention to prove that chilled wheels could be made equal to, if not superior, in strength and wearing qualities to any manufacture of steel-tired wheels that could be found.

#### PERSONAL.

Mr. Geo. Greer, a well known engineer on the Louisville, Henderson & St. Louis, has been appointed traveling engineer.

Mr. C. H. Conrad has been appointed foreman of the blacksmith shop of the Columbus, Hocking Valley & Toledo, at Columbus.

Mr. James A. Corey, a locomotive engineer on the Boston & Maine, has been appointed master mechanic of the shops at Portsmouth, N. H.

Mr. A. D. McCullom has been appointed division master mechanic of the Cincinnati, Hamilton & Dayton road, with headquarters at Hamilton, O.

Mr. A. S. Work, formerly road foreman of engines of the Nickel Plate, has been appointed general foreman of the company's shops at Chicago.

Mr. F. M. Raikes has been appointed assistant general manager of the Texas & Midland Railway, in charge of the transportation, track and mechanical departments.

The Central Railway Club has elected the following officers for the coming year: President, John S. Lentz; vice-president, E. A. Miller; secretary-treasurer, Harry D. Vought.

Mr. P. E. Garrison, formerly master mechanic of the western division West Shore road, has been appointed master mechanic of the Fonda, Johnstown & Gloversville Railway.

Mr. E. D. Warner, of Philadelphia, has been appointed by the imperial government of Japan as inspector of the locomotives the Brooks locomotive works are building for that country.

Mr. Harry Conrad, who has been employed at the Dennison shops of the Panhandle, has resigned to become assistant master mechanic of the shops of the Columbus & Hocking Valley at Columbus.

Press reports recently announced that Mr. D. G. Moit, master mechanic of the Panama Railroad, was drowned while out yachting with a party of friends. No further information has been received.

Mr. S. F. Forbes, general store-keeper of the Great Northern, has resigned to become superintendent of that company's shops at St. Paul. Mr. W. G. Tubby succeeds Mr. Forbes as general storekeeper.

The Railway Age has closed its Philadelphia office and Mr. H. B. Greening, who represented the paper in that territory has, we believe, entered the service of the Commercial Advertiser of New York.

Mr. George Dickson, general foreman of the locomotive and car shops of the Great Northern at Como (St. Paul) has been transferred to West Superior, where he takes charge of the company's mechanical department.

Mr. T. Addison Busbey, for fifteen years the news editor of the Railway Age, has been elected secretary of the Railway Age Company. The conferring of this title is a graceful recognition of Mr. Busbey's long term of faithful service.

Mr. E. E. Rittenhouse, who has been widely and favorably known as the sales agent of the Gravity Car Coupling Company, has gone to Corea to set up a lot of Brooks locomotives which are being sent there for the new railway between Chemulpo and Seoul. Mr. Rittenhouse's many friends will unite in wishing him a happy experience with this rather novel assignment in the Orient.

Mr. John F. Wallace, whose resignation as chief engineer of the Illinois Central R. R. to become vice-president and general manager of the Matheson Alkali Co. of Providence, R. I., we noted some time ago, has returned to the field of railway work. He has accepted the position of assistant second vice-president of the Illinois Central R. R. In this new post with his old company he will have general charge of maintenance of way and structures and will make a specialty of studying out methods of effecting economies in the operation of the road.

#### SUPPLY TRADE NOTES.

W. C. Baker has recently received an order for twenty-eight fire-proof heaters from the Great Northern Railway. They have been shipped to the Barney & Smith Car Company.

It is stated that the Lake Shore contemplates the erection of additional repair shops at Dunkirk, owing to the increased business, at that end of the line, and partly to the crowded condition of the company's shops in East Buffalo.

"Defects of M. C. B. Couplers and their Cures" is the title of a handsome pamphlet just issued by the Railroad Supply Company of Chicago. The pamphlet comprises notes on the weak points and mechanical defects of the present M. C. B. couplers as commonly used, and also some notes on the Hien automatic coupler, which is modestly asserted to overcome such

defects. It is a very suggestive little work, and is handsomely illustrated. Not the least picturesque features of the illustrations is the excellent likeness of Phil Hien, who is so well and favorably known in the coupler field. The typographical arrangement of the pamphlet is unusually handsome.

The Hewitt Steel Truck Company has been organized with H. H. Hewitt, president, and R. C. Board, secretary and treasurer. The main office of the company is in Ellicott square, Buffalo, N. Y., with branch offices in the Monadnock block, Chicago, and the Havenmeier building, New York city. The difficulties met in forming the parts of this truck have all been overcome and the company, in a very short time, will be ready to fill orders.

Mr. J. W. Gardner, who for the past six years has been the general sales agent for Manning, Maxwell & Moore, with office at Chicago, has resigned his connection with that company and accepted the position of general sales agent with the Stirling Co., makers of water tubes boilers. Mr. Gardner's leaving of the machine tool field is quite an event, for he has long been considered not only an active worker in that field but also is one of the very best posted authorities on machine tools in the country.

The Chicago Pneumatic Tool Company at its annual meeting, held January 11, elected J. W. Duntley president, J. F. Duntley vice-president and Leroy Beardsley secretary and treasurer, and at the same time declared a quarterly dividend. The company did over twice the business in 1897 that it did in 1896, and December, 1897, was the largest month of the year, showing that its business is constantly increasing. January of this year is expected to show a larger total business than did any month of last year. The company recently received cable orders from Europe for thirty No. 2 hammers, thirty No. 3 piston air drills and five pneumatic riveters.

The Sargent Company of Chicago is introducing some very fine open hearth cast steel for electrical machinery. This steel combines with great strength and ductility absolute soundness and uniformity. Careful tests conducted by Prof. W. M. Stine, of the Armour Institute of Technology of Chicago, Ill., have shown a remarkable similarity between the best Swedish iron and Sargent cast steel in electric conductivity and permeability. The magnetization curves and hysteresis cycles, as given in diagrams just issued by the Sargent Company, graphically show this remarkable similarity between the two metals.

The Klondike country seems to contain a bonanza for the Wells Light Manufacturing Company as well as for those who dig for gold. Eight of the lights are now in use by the Chilkoot Railroad & Transportation Company at Pyra and shipments of them have only just begun. In that region there are from eighteen to twenty hours of darkness every day in winter and the Wells light is absolutely necessary. The company is also preparing for shipment a device for thawing the earth at the mines. The dirt or gravel in which the gold lies in the Klondike country and also the earth which has to be removed to reach the gold-bearing stratum is frozen solid and must be thawed before it can be removed. The usual method of thawing is to build fires of wood on the earth but this process is both very slow and very expensive. The burner designed by Mr. Robinson, the general manager of the Wells company, throws an immense flame against any point to which it is directed and will thaw the frozen dirt with great rapidity. The device uses gasoline vapor forced through the burner by air pressure like the ordinary Wells light.

The Inland Iron and Forge Company has bought the entire plant, lands and buildings at East Chicago, Ind., formerly owned by the East Chicago Iron and Steel Company. A large force of men has been engaged in overhauling the plant, and has placed it in first-class physical condition. The mill is now in full operation and the company is prepared to promptly execute all orders with which it may be favored for bar iron covered by the following range of sizes: flats,  $\frac{1}{2}$  to 10 in. wide by No. 12 to 2 in. thick; flats, round edge (for tires),  $\frac{3}{8}$  to 4 in. wide by 3-16 to 1 in. thick; rounds,  $\frac{1}{4}$  to 3 $\frac{1}{2}$  in. diameter; squares,  $\frac{3}{8}$  to 2 $\frac{1}{2}$  in. diameter; ovals,  $\frac{1}{2}$  to 1 in.; half ovals,  $\frac{1}{2}$  to 1 $\frac{3}{4}$  in.; half rounds,  $\frac{3}{8}$  to 1 $\frac{3}{8}$  in.; beveled edge shaft,  $\frac{3}{4}$  to 1 $\frac{1}{2}$  in. wide by 3-16 to  $\frac{3}{8}$  thick; beveled edge tongue cap, 1 $\frac{3}{4}$  to 2 $\frac{1}{4}$  in. wide by No. 10 thick; beveled edge wagon box,  $\frac{3}{4}$  to  $\frac{5}{8}$  in. wide by No. 14 to 10 thick; angles (equal legs),  $\frac{3}{4}$  to 3 in.; channels,  $\frac{1}{2}$  to 2 in. wide by 3-32 to  $\frac{1}{4}$  thick. The quality and finish of their iron is guaranteed to be found satisfactory in every particular. The officers of the company are: President, P. D. Block; vice-president, S. J. Llewellyn; general manager, L. E. Block; secretary and treasurer, G. H. Jones. The office is at 1227 to 1229 Marquette building, Chicago.

Scientific Progress in the Closing Century is the title of an article in Appleton's Popular Science Monthly for February, by Professor Ludwig Biecher. The high position which Professor Biecher occupies in the scientific world, and the great wealth of his subject, makes certain a most interesting article.

# RAILWAY MASTER MECHANIC

WALTER D. CROSMAN, Editor.  
EDWIN N. LEWIS, Manager.

PUBLISHED MONTHLY BY

THE RAILWAY LIST COMPANY

Devoted to the interests of railway motive power, car equipment, shops, machinery and supplies. Communications on any topics suitable to these columns are solicited.

Subscription price, \$1.00 a year, to foreign countries \$1.50 free of postage. Advertising rates given on application to the office, by mail or in person. Address

THE RAILWAY LIST COMPANY,

The Rookery, Chicago, Ill.

The Official Railway List is published by this company.

VOL. XXI. CHICAGO, MARCH, 1898. No. 3.

It was a happy thought on the part of the authorities of Purdue University to assign the topic of business problems of the motive power department to Mr. Robert Quayle, for its series of railway lectures. Mr. Quayle was apparently just the right man to undertake this work, for the lecture, the substance of which we give elsewhere in this issue, most thoroughly illumines this very important topic. The business end of the duties of a superintendent of motive power has been too often neglected in the past and it is none too soon to have it brought into prominence.

The conventions are again almost upon us. The secretary of the Master Car Builders' Association, and of the Master Mechanics' Association, and the secretary of the standing committee of the railway supply men have both sent out their circulars announcing the fact and telling all about what should be done to secure desired accommodations at Colonel Clement's famous Congress Hall hotel at Saratoga. That Saratoga will be the place for the next meeting was almost a foregone conclusion long ago, and of course Congress Hall was selected as the headquarters. The usual arrangements have been made as to hotel rates, and the exhibitors have had the way well paved for them, as will be seen in the announcements elsewhere given in this issue.

It was noted recently in these columns that the air brakes on the Lake Street Elevated Railroad, Chicago, were causing considerable worry because of the frequent emergency application obtained when a service application was desired. It seemed peculiar that brakes on cars which were so far removed from the elements which so frequently cause difficulty on surface roads should cause more anxiety from the difficulty mentioned than was experienced with brakes on surface cars. It was said that the supposition was that the trouble was caused by taking the supply of air for the pump from the interior of the cars, and that the experiment would be made of taking the supply from the outside of the cars. This has now been done and all cars are piped to supply the pump from the outside of the car, and the aggravating difficulty has been entirely obviated.

The value of charts and similar graphic methods for so placing facts before the eye that a glance will reveal the story to be told has often been pointed out in these columns. Graphic records are used on the Chicago Great Western Railway more extensively, probably, than upon any other road; and the hints as to their practical application given by Mr. Lyon, in the paper given elsewhere in this issue, will be read with decided interest. Mr. Lyon states that, after the charts are once prepared and started it requires hardly the whole time of one man to keep them up. Of course the regular tabulations of records must be made; but the investment in the comparatively slight clerical labor required to present all the significant facts of those records graphically before the eye of the superintendent of motive power is much more than warranted. Not only is time saved for both the head of the department and for the clerks whom he would have to set to work digging out suddenly-desired facts from an appalling

mass of records, but, more than this, the graphic chart sets forth these facts so much more clearly in their true relative values than it is possible for tabulations to do, that the result to the seeker is far more impressive. Mr. Lyon says on this point, referring to pay roll diagrams: "Your attention is called by 'humps' to matters that would not ordinarily be noticed. It is like having a man there whose business it is to pull your coat every time something happens to which your attention should be drawn. The diagrams do the pulling themselves. They strike your eye whether you will or no." There is no doubt but that these charts are of great value and worthy of adoption in many lines of office records.

The Railway Master Mechanic has taken occasion at intervals during the last year or two to urge the necessity of keeping the side bearings on cars, and on locomotive tenders also, free from each other. We have urged that although it was necessary, even with the light capacity cars, to keep the side bearings free, it is decidedly more important with the heavy capacity cars that the top and bottom side bearings do not touch when the car is loaded. The subject is brought to mind again by the fact that a railroad, and one which does not have a reputation of being a crooked one, has found that on certain of its divisions which have more curvature than other divisions (but not heavier grades) that the same class of locomotives are capable of hauling one or two cars per train more on the divisions having the lesser curvature. The officials of this road have concluded that the difference was due to the harder curving of the cars when the top and bottom side bearings are in contact. Should it be possible to prove this beyond a doubt, and should several roads satisfy themselves of the importance of the matter, there is a probability that the side bearing question will receive more attention, and this will necessitate, of course, a thorough consideration of the design of body and truck bolsters.

A number of years ago a trunk line showed its appreciation of the necessity of trucks curving easily by supplying to its car inspectors oil cans with spouts long enough to permit reaching the center plates from the side of the car, and insisting that the center plates of loaded cars be oiled at inspection points. A refrigerator car loaded and going east, recently caused a wreck, and the railroad officials concluded that the wreck was caused by the fact that nearly the entire load of the car was carried on the side bearings. The owners of the car, a comparatively small company, have since adopted metal truck holsters, having formerly used a trussed oak bolster. This may be an extreme case, because meat cars are most severe on the body bolsters.

When the necessity of keeping the side bearings well separated is more thoroughly appreciated, the metal bolsters will receive more attention and the proper distribution of the load on the bolster—the body bolster—will be more carefully considered.

## ROLLING WEARING SURFACES.

Some attention is being given to burnishing (so called, although it is really rolling) the journals of axles, the wearing surfaces of crank pins and similar parts of locomotives and cars. The claim is made that a much better wearing surface results and that there is less liability of the parts becoming over heated in service. There is every reason for believing that such manipulation of wearing parts should give much satisfaction. The cutting tool, no matter how well dressed and no matter how skillfully operated, will not leave an entirely smooth surface, and in the case of some metals the cutting tools leave a very rough surface, so rough in fact as to make the metal unsuited for wearing surface.

For rolling axles and crank pins the roller is provided with a suitable support on the tool post and is used to remove the sharp cornered spiral which may be left by the cutting tool. It appears that the roller is more effective on wrought iron than on steel or that a greater pressure must be used on steel to produce an effect resembling the effect produced by a less pressure on wrought iron. This is to be expected because the wrought iron is more compressive than the steel, to such an extent even that the bearing may sometimes be made flat in places, due to the impurities in the iron. This, however, has not seemed objectionable.

It was stated above that in the case of some metals the cutting tools leave them very rough, too

rough for wearing surfaces; this is the case with cast steel, and where cast steel is used for driving boxes, that part which wears on the shoes is generally faced with some more suitable metal such as tin or bronze or brass. The cutting tools leave the cast steel very rough and, apparently, "pull up" the fibre and leave its ends projecting so that the surface is not at all suited to wear with the opposing face on the shoe or wedge of the pedestal or of other part. Some shops have found that by rolling the surface of the cast steel part it is not necessary to face it with other metal to produce a satisfactory wearing surface. This being the case it is possible that the process of rolling wearing surfaces may result in much benefit to both manufacturers and to railroad companies, by making available for certain parts, metals which heretofore have seemed either unsuited or too costly to manipulate. Referring to the driving box of a locomotive, many roads have desired to use cast steel, but the cost of protecting the wearing surfaces by covering the steel with some other metal has rather operated against such use. If, however, a suitable surface can be made on the cast steel by rolling, and such seems to be the case, this should be of interest to the steel manufacturer and to railroads, and perhaps it would be well for both the makers of cast steel and the railroads to learn if the idea cannot be carried farther.

## HOT BOX REPORTS.

The system in use on many roads, requiring the conductor of a train to make out a hot box report, specifying the cause of heating, in all cases where a journal runs hot, causes a vast amount of trouble and expense and does not arrive at the results expected.

The causes for a journal running hot are so numerous that only an expert examination can determine them, and many times even that fails to find the cause, although on the "hot box reports" the cause is never lacking.

Should a journal run hot from some unaccountable reason, the conductor makes out his report and sends it to the superintendent, almost invariably specifying the cause of heating to be either "lack of oil" or "brass worn out." This report is forwarded from the superintendent's office to the mechanical department, usually with the notation, "inspectors evidently not giving the cars proper attention." The man who oiled this train is reprimanded for not attending to his business; and as a result more oil is used, notwithstanding the fact that the original trouble might have been caused by anything but lack of oil.

Another favorite reason for heating seems to be "brass worn out." On one report recently brought to our attention three brasses were applied to one journal in running less than one hundred miles, and each brass removed was specified as worn out. Undoubtedly they were worn out after the babbitt was melted out, as they were filled brasses, but this was not the cause of the hot box, although it was so reported and forwarded from the superintendent's office.

If it was possible to definitely arrive at the cause of hot boxes, remedies could be applied to prevent them, but it is doubtful if this can ever be accomplished with the present equipment and methods of loading, as we find cars in the same train whose capacities vary from 28,000 to 60,000 pounds and whose journals run from  $3\frac{1}{2}'' \times 6''$  to  $4\frac{1}{4}'' \times 8''$ , and all subject to the same service. Some information might be obtained on this subject, if careful examination could be made when a journal first began to heat, but after it becomes hot, it is impossible to arrive at any definite conclusion unless the trouble is caused by a defective journal, which will often escape detection until removed from the truck.

Cheap oil, cheap waste, and cheap brasses, and the general condition of the dust guards in the oil boxes, are responsible for more hot boxes than lack of oil or inattention.

## THE ASSUMPTION OF RISKS BY EMPLOYEES.

One of the legal questions of much importance to railway employes is that pertaining to the assumption of the risks of their employment. There are a great many decisions on the subject, but they tend, for the most part, to increase the uncertainty that surrounds it. Recognizing something of this, and on account of the question never having been quite definitely settled in its jurisdiction, the supreme court of Texas has reviewed the authorities, with great care, and formulated its conclusions in the re-

cent case of the Texas & New Orleans Railroad Company against Bingle.

The supreme court says: The servant, by entering the employment of the master, assumes all the ordinary risks incident to the business, but not those arising from the master's neglect. It is the duty of the master to exercise ordinary care to furnish him a safe place in which to work, safe machinery and appliances, to select careful and skillful co-workers, and, in case of a dangerous and complicated business, to make such reasonable rules for its conduct as may be proper to protect the servants employed therein. The servant has the right to rely upon the assumption that the master has done his duty; but if he becomes apprised that he has not, and learns that the machinery is defective, the place unnecessarily dangerous, or that proper rules are not enforced, he assumes the risk incident to that condition of affairs, unless he informs the master, and the latter promises to correct the evil. In this latter event, so long as he has reasonable grounds to expect, and does expect, that the master will fulfill his promise, he does not, by continuing in the employment, assume the additional risk arising from the master's neglect. If he then be injured by reason of that neglect, he may recover damages, provided it be found that a man of ordinary prudence, under all the circumstances, would have encountered the danger by continuing in the service. This, the supreme court says, it understands to be the rule in the English courts. It declares it to be the rule in the supreme court of the United States, and to be supported by the weight of authority. Somewhat different views are attributed to Massachusetts and Missouri decisions.

#### THE WORK BEFORE THE M. C. B. ASSOCIATION.

Last month we made some review of the work ahead for the Master Mechanics' Association, and it was so well received that we essay to briefly review the topics which the Master Car Builders' Association has underlined for committee work.

The three standing committees have charge of subjects which indicate the high standard which American railroads now aim at in matters pertaining to track as well as the mechanism of car details. The practice of some roads also illustrates how far short of these high ideals it is possible to work and yet conduct successful railroading.

The committee on tests of triple valves will probably not have any tests to report, as we have not heard of any triples having been submitted for investigation. At the same time it is well known that triples are being applied to freight cars in large numbers, which do not meet the requirements of the M. C. B. recommended practice for air brake triple valves, and which when used in connection with the Westinghouse quick action triple, impair the efficiency of its quick action. As we understand the situation, it was the purpose of the M. C. B. report, which was adopted as recommended practice, to prevent such triple from getting into service, and in order to carry out this purpose the standing committee on triple valves was appointed. While, therefore, this committee may not be able to report results of tests of triples submitted to them, they may rightfully enter complaint that if the interchange rules continue to accept triples not up to standard, and no valves are sent to them for investigation, there is really no use for a standing committee on this subject, and they might as well sit down. It is possible that Mr. Rhodes may be able to make some recommendation to the convention, to so modify the interchange rules, that the present condition of affairs may be improved, and there may be some work for the committee in the future.

The standing committee on wheel and track gauges was appointed because the American Railway Association announced that it had adopted a standard track gauge of 4 ft. 8½ in., and guard rail throat 1¾ in. The wheel ganges and limits for mounting in use had been designed as a compromise, and it was then thought possible to narrow the range of limits to more exact conditions. The Pennsylvania Co. offered the association the use of a piece of track for experimental purposes, to determine whether wheels mounted to the standard wheel gauge and running on a track 4 ft. 8½ in. gauge will give the least tractive resistance. This is an important experiment and it is hoped that the committee will carry it out carefully so that no doubt can be raised as to its conclusions.

Another matter which this committee ought to settle is the correct method of mounting wheels having different thickness of flanges. While the report made last year places this subject in much better shape than ever before, yet it is evident that if it is found necessary to change the standard wheel gauge as a result of the proposed experiments, then all limits relating to the mounting of wheels would require revision. The correct method of gauging and mounting wheels, especially those having irregular flanges, was thoroughly analysed by Mr. George Tatnall, in a paper before the New York Railroad club, February 18, 1897.

Mr. Tatnall presented a design for an improved wheel gauge and recommended the following rule: "The standard distance between inside of flanges shall always be the difference between the constant figure, 4 ft. 6¾ in., and the variable found by measuring the thicker flange of the two to be mounted." It is found, however, in actual practice that the average difference in the thickness of flanges of old wheels to be mounted, may be made as small as one sixteenth of an inch, and the association adopted this limit by the last letter ballot.

The standing committee on brake shoe tests have probably done no work on the laboratory testing machine; but the work of a brake shoe company on this machine has brought out the fact that it is possible to make a brake shoe having a fractional resistance equal in degree and efficiency to the standard cast iron shoe, but having also wearing qualities from four to six times as long. This is enough glory for one year, but it belongs to the Sargent Company, and not to the M. C. B. standing committee on brake shoe tests.

Rust from salt drippings from refrigerator cars, injuring rails and trucks, may not seem of so great importance, yet the increasing number of refrigerator cars and the large amount of corrosion caused by them calls for some prompt remedy. It has been proposed, and we believe carried out by one or two companies, to place the drip pipe at the center of the car laterally, and as near the track as possible. This avoids the rails, and can be so directed as to avoid the truck to a large extent, and may be considered as good an improvement as can be expected this year.

Trains parting, caused by the M. C. B. coupler becoming unlocked, reveals one of the most serious defects in that curious ill-favored and misshapen device. A lock for the lock is now the burden of the song of the coupler man. It is pitiful to see the numerous unmechanical contraptions which have been compelled to perform the simple function of the latch, and many of the failures of the M. C. B. coupler, including its tendency to uncouple when it should be intact, are due to this fact, that in order to get a patent, or avoid another, a good plain, straightforward design for a lock has been sacrificed. An effort should surely be made to keep down the number of designs for M. C. B. couplers, and to perfect by improved design those which remain.

Tests of air brake hose to determine which is the best have been made in various ways, and railway test departments have made specifications, based on different methods of inspection, but nothing very satisfactory has come of it all. The information as to the cause of air brake failures is, however, rapidly accumulating, and the railroads are learning how to take better care of their hose, and the rubber companies are learning how to make cheap hose well adapted to the purpose, and thus conditions are improving every year, and we expect Mr. Waitt to report encouraging progress.

Freight trucks are changing so rapidly from wood to metal, that it is almost too late to consider a standard spring for diamond trucks. Good springs are almost indestructible, and there should be an accumulation of freight bolster springs from old trucks, which ought to be available for most repair requirements. The defect in most trucks heretofore has been the short vertical distance between the spring plank and the bolster, only 6 or 7 in., and this has limited the height of bolster springs to the same figure. An improvement in the diamond truck, which places the springs in a stirrup or hanger inside the arch bars, allows a height of 8 or 9 in., which admits a higher spring, and one having a greater deflection per unit load and gives a much easier motion. For metal trucks of one type very stiff springs are required, and this is due to same defect above described for old trucks, the small vertical spring space. Other designs for metal

trucks recognize this fact and admit much higher springs. It will be seen that quite a number of standards will be required to suit the different types of trucks, and if the committee cannot recommend a few special designs, which will be generally acceptable, they can at least point out the principles which should govern good spring proportions.

Thermal tests for car wheels, while at first ridiculed alike by railroad and wheel makers, have gradually become recognized as legitimate and valuable requirements. For heavy braking on mountain roads, ordinary car wheels are not now considered safe and many fail. The investigations which have been made in the past few years have taught wheelmakers how to meet the difficulty, and to make a wheel which can be heated up by the brake shoes and not crack the plates. It is true that such wheels cannot be made of a cheap mixture consisting largely of scrap, but the price of a good wheel guaranteed for mountain service is so low that railroads can well afford to pay the slight advance it may cost.

Steel car framing is making such rapid advances that the plans made a year or two ago now seem antiquated, and the committee in charge can only review them as a matter of history, and not with any serious intention of selecting any one of them for a standard. The plans were made for 60,000 lbs. capacity, and before the next convention meets there will be in service thousands of steel cars having 100,000 lbs. capacity. In the face of such a rapid development it will not be possible for the association to adopt a standard steel car for years to come. Wooden cars will doubtless remain the prevailing construction for interchange business so long as 60,000-lb. cars can be economically used, and the experience gained in steel construction for special service in local traffic will gradually point out the best design for an interchange car. It only remains for a committee on steel car framing to make a record of this development.

#### NOTES OF THE MONTH.

Our readers will remember the notable order for 600 steel cars given by the Pittsburg, Bessemer & Lake Erie Railway last year and the feeling then generally expressed that the turning point had come in the history of the all metal car. The Schoen Pressed Steel Company received that order; and additional orders from the same road brought the total up to 1,000 cars. Subsequently orders were received by the same firm for steel cars from the Pittsburg, McKeesport & Yonghiogheny, the Bntte, Anaconda & Pacific (for copper ore cars), and from other roads, for smaller numbers of cars. Lately the Schoen company has received quite a number of larger orders as follows:

Two hundred Pennsylvania Company coal and ore cars, 110,000 lbs. capacity.

Four hundred and fifty B. & O. Northwestern System (Pittsburg & Western), coal and ore cars, 100,000 lbs. capacity.

One hundred Pittsburg & Lake Erie coal and ore cars, 100,000 lbs. capacity.

Forty Lake Superior & Ishpeming ore cars, 100,000 lbs. capacity.

All of these cars are self-clearing and will be built from the plans of Charles T. Schoen. The Diamond pattern of pressed steel truck which the Schoen Pressed Steel Company manufacture, and which has proven so meritorious, will be used under all of these cars. The Pennsylvania and Pittsburg & Western cars are to be used for hauling coal to the lakes from Pittsburg and bringing back ore, and are to have 5½x10-inch journals; the others are to have 5x9-inch journals.

\* \* \* \* \*

These orders coming only after most careful inquiry and investigation into the merits of the steel car by officials of roads known to be most conservative would seem to practically settle the future of the steel car. None of these cars will weigh over 34,100 lbs., notwithstanding their great carrying capacity, and those for the Lake Superior & Ishpeming only weigh about 20,000 lbs. The latter are only 22 feet long and are designed especially for the Lake Superior iron ore trade, the hoppers being arranged to unload into pockets at the docks only 12 feet apart. It is predicted that their general adoption in this region is but a question of time. So general has become the inquiry concerning the steel car that the Schoen company cannot but feel that

transportation officials have begun to realize in earnest what a large money saving can be obtained from its use, the gain on account of reduction in dead weight and the saving in cost and maintenance alone being exceptionally great. The fundamental underlying thought of the designer and the company building these cars was—is it possible to build a steel structure of this character as cheap per ton of carrying capacity as a well designed modern wooden car can be built for. This has been accomplished by the expenditure of a very large amount of money in plant and a very economic design of car in so far as weight and workmanship are concerned. It has been clearly demonstrated that a steel car adapted for hauling fixed car loads and fixed train loads of material can be built of steel entire as cheaply as a wooden car of modern design can be per ton of carrying capacity. We give elsewhere in this issue some interesting estimates of the saving in cost of maintenance, and of the gain due to saving of dead weight, to be had by the use of steel cars. The Pittsburg, Bessemer & Lake Erie cars above referred to were illustrated and described in our issue of July, 1897, page 98.

\* \* \* \* \*

The question of changing the date of the annual meetings of the Traveling Engineers' Association came up at the last annual meeting at Chicago. The subject provoked considerable discussion both

Theodore C. Search, have been removed from No. 1743 North Fourth street, to the Bourse, Fourth street below Market, Philadelphia. We gave quite an extended account of this important association and its work in our February issue.

\* \* \* \* \*

The plan by which the Baltimore & Ohio is to secure needed additions to its car equipment is quite interesting. Receiver John K. Cowen of that road makes the following statement in regard to the recent application filed in the U. S. court for the District of Maryland for the leasing of 5,150 cars. (The application has since been granted by the court). "The obligation made by the receivers of the Baltimore & Ohio Railroad for the acquisition of new equipment covers the following contracts: Two coal companies, the Moonongah and the Montana, purchase 900 coal cars, and the company and its receivers agree to use these cars, paying the regular mileage of six mills per mile run. The coal companies make the contracts for the purchase of the cars, and the obligation of the receivers is simply to use the cars at the regular mileage rates during the period of the receivership. The Pittsburg Junction Railroad Company purchases 1,250 cars and makes its own financial arrangements for their acquisition, by the issuance of the ordinary car trust obligations. The receivers of the Baltimore & Ohio

and then the rate is \$1.50 per car, until another figure is reached, when the rate becomes \$1 per car. The Junction Company at the end of the year refunds to the B. & O the excess, as settlements are made on the \$2 basis, and the only obligation the receivers take is that the Pittsburg Junction Company can use the excess to pay the car trust, and when the cars are thus paid for they belong to the Baltimore & Ohio Railroad Company. The receivers obtain by lease from the Pullman Company 3,000 cars, and the only obligation which they assume in relation to these 3,000 cars is to pay a rental for them equivalent to ten per cent of their cost each year, for the period of two years, and the interest upon the cost for the same time. No equipment obligations are issued. The receivers' obligation is, therefore, substantially \$300,000, being the rental payments for two years, and without the issuing of any car trust obligations. Therefore, the net result of the whole affair is that the Baltimore & Ohio Railroad Company secures 5,150 cars, and the receivers' obligation for principal amounts to about \$300,000, payable in two years. The mileage alone on the 3,000 cars to be secured from Pullman will be considerably greater each year than the interest and principal payments."

\* \* \* \* \*

The Association of Railroad Air-Brake Men will

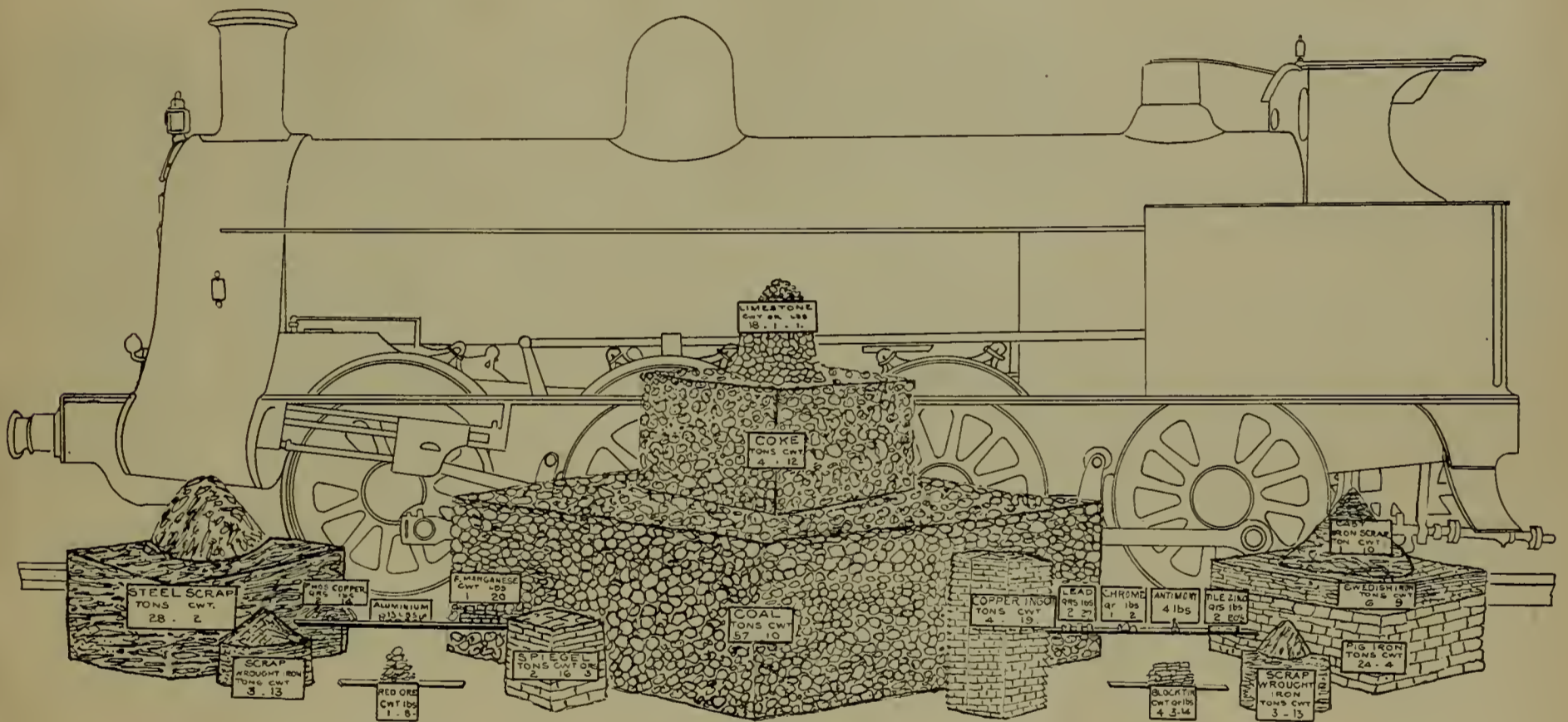

A LOCOMOTIVE AND ITS EQUIVALENT IN RAW MATERIAL.

It would hardly be realized that the raw material from which a locomotive is made weighs about three times as much as the finished engine. But a careful estimate made by Mr. F. W. Webb, locomotive superintendent of the London & Northwestern Railway, shows that this is the case—at least with one of his typical eight-coupled locomotives. The sketch given above shows the locomotive in question, with the various raw materials neatly piled up in front of it to show graphically their relative values. Our sketch is made from a faint reproduction made by London Engineering from a photograph supplied to it by Mr. Webb, and is not absolutely accurate in detail; but the main story is nevertheless well told by the picture. The exact figures, as given by Engineering, for each element going to make up the finished engine, are as follows:

	Tons.	cwt.	qrs.	lbs.		Tons.	cwt.	qrs.	lbs.		Tons.	cwt.	qrs.	lbs.
Coal . . . . .	57	10	0	0	Spiegel . . . . .	2	16	3	17	Ferro-manganese . . . . .	0	1	0	20
Steel scrap . . . . .	28	2	3	15	Cast-iron scrap . . . . .	1	10	1	15	Red ore . . . . .	0	1	0	8
Pig iron . . . . .	24	4	0	7	Limestone . . . . .	0	18	1	1	Chrome . . . . .	0	0	1	2
Scrap, wrought-iron . . . . .	7	6	0	0	Block-tin . . . . .	0	4	3	14	Aluminium . . . . .	0	0	0	13
Swedish iron . . . . .	6	9	0	0	Lead . . . . .	0	0	2	27	Antimony . . . . .	0	0	0	4
Copper ingot . . . . .	4	19	1	21	Tile zinc . . . . .	0	0	2	20½					
Coke . . . . .	4	12	0	0	Phosphorous copper . . . . .	0	0	2	14	Totals . . . . .	138	18	2	2½

for and against changing the date. The question was finally disposed of by the convention ordering the executive committee to send out a letter ballot to all members giving them a chance to vote on the question. The ballots were sent out and the polls were held open until January 1, 1898, when the executive committee ordered the secretary to close the ballot. The result of the ballot was a majority in favor of holding the annual meetings the second Tuesday in September the same as heretofore.

\* \* \* \* \*

The general offices of the National Association of Manufacturers, including the office of the president,

Railroad agree to use these cars and pay the regular mileage rate of six mills per mile run. The only further obligation which they incur in relation to the same is that they assent to the Pittsburg Junction Railroad Company applying, as far as may be necessary, the sum which that company refunds at the end of each year to the Baltimore & Ohio Railroad Company for excess charges for transportation of cars over its line. Under the contract with the Baltimore & Ohio Railroad Company, the Pittsburg Junction Railroad Company receives \$2 per car until the number of cars arrives at a certain figure,

hold its convention in Baltimore, Md., April 12th, 13th and 14th. The Carrollton Hotel will be headquarters, where the following special rates have been made for the members of the association and their friends: Rooms on first and second floors, \$3 per day for each person. Should four persons occupy the same room, \$2.50 per day. Rooms fourth, fifth and sixth floors, \$2.50 per day. Rooms with baths, \$3.50 per day. Rooms can be engaged in advance, but it is not considered necessary, as the house is amply large. The convention will be called to order promptly at 9 o'clock, Tuesday morning, April

12, in the Dnshane Hall, Rains Building, No. 409 Baltimore street, two blocks from the hotel. The coming convention at Baltimore promises to be one of the most instructive and successful in the history of the association. The papers to be read will undoubtedly be the best ever presented at any convention. P. M. Kilroy, secretary, Pine Bluff, Ark., can give further information.

\* \* \* \* \*

The Baltimore & Ohio Southwestern Railway Company has changed its dining car system from table de hote to a la carte with the result of increased profits, better service and greater satisfaction on the part of the patrons. The cars are open for business during the entire time they are on the train and the innovation seems to have met with the approval of the passengers.

\* \* \* \* \*

Such of our friends that are planning to reach out for Chinese trade may find a helpful suggestion in the following clever lines, which were recently published in the Chicago Record by William E. Curtis. A friend of his, who was sent to China on a commercial mission more than a year ago, describes his experience in trying to "hustle the east," as Rudyard Kipling calls it:—

"My friend have you heard of the town of Foochow  
On the banks of the River Slow,  
Where blooms the waitawhile flower fair,  
Where the sometime-rother scents the air,  
And the soft go-easys grow?"

"It lies in the valley of Whatstheuse  
In the province of Letterslide,  
And that tired feeling is native there.  
It's the home of the reckless Idontcare,  
Where the givetups abide.

"It stands at the bottom of Lazy Hill, and is easy to reach,  
I declare,  
You've only to fold up your hands and glide  
Down the slope of Weakwill's slippery slide  
To be landed quickly there.

"The town is as old as the human race,  
And it grows with the flight of years,  
It is wrapped in the fog of idlers' dreams,  
Its streets are paved with discarded schemes  
And sprinkled with useless tears."

\* \* \* \* \*

Secretary Jno. W. Cloud notifies members of the associations who wish accommodations at Congress Hall, Saratoga, for the June conventions, that they should make early application for rooms in order to be sure of accommodations. Applications should be made to H. S. Clement, Manager, Congress Hall, Saratoga Springs, N. Y. who has made the following terms for members and their friends: Single room, one person, without bath, \$3 per day; double room, one person, without bath, \$4 per day; double room, one person, with bath, \$5 per day; double room, two persons, without bath, \$3 per day, each person; double room two persons, with bath, \$4 per day, each person.

\* \* \* \* \*

CONCORD SHOPS—BOSTON & MAINE RAILWAY.

The Boston & Maine has new shops at Concord, N. H., that are admirably arranged. Our engravings show the general ground plan of the complete plant, and also the floor plan of the machine and erecting shop, the tool locations being completely indicated. Aside from the building devoted to the storehouse all the buildings are one story in height, and they are all built of brick, with the exception of the lumber shed. The roofing is gravel on the paint shop, lumber shed, car repair shop and oil storehouse, and of steel on all other buildings. The buildings are so located that they can be extended if desired, ample space between them being left for this purpose and their ends being so constructed as to admit of easy removal in case extension is required.

The general arrangement was so designed as to permit of a properly economical movement of material and finished parts through the shops. Ample access by track is provided, entrance being arranged for each end, and for each side at the middle of the shop yards. The power plant is centrally located in one building, and an elaborate system of distribution of power by electricity is provided. Reference to our engravings will reveal quite fully the general ideas followed in planning these shops. The capacity of the shops is such as to care for 300 locomotives. The car shops can handle 400

freight cars and 50 passenger cars per month. The three tracks in the erecting shop are provided with pits, and are served by two 30-ton Sellers' traveling cranes. The arrangement here is particularly good.

The entire plant is very completely fitted with water, sewer, and air piping and electric wiring for light and power. The heating and lighting arrangements have been carried out with especial care. Superintendent of Motive Power Henry Bartlett is to be congratulated upon the acquisition of such a fine plant for his department.

GRAPHIC METHODS AS APPLIED TO RAILWAY RECORDS.\*

BY TRACY LYON.

One often feels rather helpless in attempting to digest a mass of figures, for the mere numbers themselves convey to the eye but incompletely their value, which is only fully appreciated with the help of considerable mental arithmetic.

It is natural, therefore, that we should find some relief in returning to first principles and mentally comparing the numbers of things as we would sticks of timbers of different lengths, and as the variety of these numbers becomes greater the advantages in this simple method of comparison are more apparent.

The use of various factors as abscissas and ordinates in graphical charts has become very common and is familiar to everyone, but I have to speak particularly of their application to railway records, as they have been developed in the Chicago Great Western Railway. Almost every department there carries a series of running graphical charts covering the figures in which it is most interested, so that sheets are supplied especially ruled for this purpose. One is the monthly sheet, so called, covering in its width ten spaces, each representing a year and subdivided into months, on a scale of one year to 1 1/2 inches, and with 30 horizontal lines to the inch, each fifth and twenty-fifth line being heavier for convenience in counting. (See Fig. 2.) The other is the daily sheet, which differs only in that its width covers one year instead of ten and there are vertical lines for each day, with heavier lines each fifth day and at the beginning of each month. (See Fig. 1.) Upon these sheets are plotted all sorts of things, from gross earnings to pay rolls, and from the number of engine failures and amount of oil used to the cost of coal per ton-mile. Such records are principally valuable as a means of comparison, for in no other way can one so readily grasp a mass of figures representing the operations of perhaps a dozen years. They also furnish an ideal index for reference to a great deal of usually ungetatable stuff.

As a demonstration of the value of a chart using only months and dollars as factors, I will describe my pay roll "diagrams," as we call them. Some 40 of the monthly sheets which I have described are bound together and on the first page is plotted the total amount of the pay rolls of my department for each month since 1890. On the next page, month by month, are plotted in groups three general subdivisions of this total, covering the pay roll of the principal shops, division stations and smaller stations respectively. On the following pages are shown still further subdivisions, including the total pay rolls of each department in the shops and each station by itself. Each one of these is carried out again by showing, grouped together on succeeding pages, the amount paid to each class of men in each department of the shops and at each station. This makes quite a book, but imagine the relief in having such a map of present and past events to turn to when some question is brought up involving the amount of money which you are justified in spending at a certain point. The alternative of a pile of dusty old pay rolls, anywhere up to a foot high, is not pleasant to contemplate and somewhat hopeless. The diagrams, on the contrary, show at a glance just how many hostlers or car cleaners, for instance, there have been at a given station at any time for years back and just what wages they have received.

Your attention is immediately and forcibly called to any increase in expenditure by an unmistakable "hump," which shows itself much more prominently than any difference in mere figures. Any change in the distribution or rate of wages is also clearly shown, this being something which is too easily overlooked with ordinary methods, when there is no change in the total of a certain pay roll.

By the use of these charts, figures can also be very easily grouped together for the purpose of comparison; plotting, for instance, on the same sheet and from the same base, the numbers of locomotives in service each month, the number in bad order and in store, the total mileage made, the total cost of locomotive repairs and the cost of repairs per mile. These are all figures which you like to see together, and it is hard to see how this could be accomplished in a more effective way. Such a vertical scale may be used for the various figures as to still further bring out their relation to each other. If the same space which represents one locomotive also represents the number of miles which that locomotive should make, the relation

\*Paper read before the Northwest Railway Club.

between the line showing the number of engines in service each month and the total mileage made is an indication as to whether or not more power is being kept in service than necessary.

There is another variety of "diagrams" which I find very convenient in affording a running history of motive power and cars, and largely taking the place of the boards and pegs often used. These boards I consider very clumsy, and moreover they do not furnish a permanent record.

Taking the locomotive first; there are six different things you wish to know about any particular engine in service in order to form an intelligent idea of what it is doing—

- First: When turned out of shop and the general extent of the repairs made.
- Second: How much these repairs cost.
- Third: The mileage made each month.
- Fourth: The times when the engine has been taken out of service for repairs.
- Fifth: The cost of running repairs.
- Sixth: The number of "failures" against the engine.

I have found that all these things can be shown in a very simple and concise manner by the use of the daily chart to which I have referred.

This method is rather hard to describe in a general way, and in Fig. 1 I have shown the history of "Engine 007" for a few months.

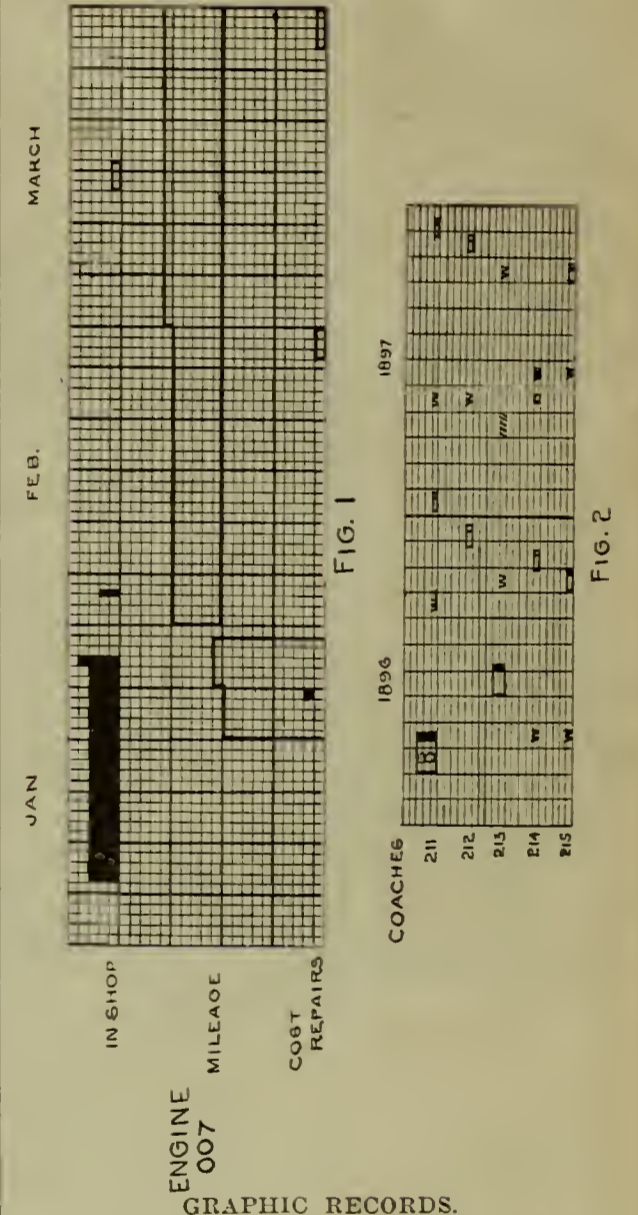

This history reads as follows: Engine 007 was taken into shop for general repairs (the height of the black line indicating this) January 7th, and turned out the 28th of the same month, at a cost of \$1,050 (in the block below, each of the small squares represents \$10). In February the engine made about 5,000 miles (5 lines are shown vertically opposite "mileage"), and in the right hand lower corner of the February space three squares are enclosed, showing that the running repairs for that month amounted to \$30. There was also a "failure" or delay to a train by the fault of 007 on February 3d—probably due to a hot box, caused by hub wear. In March 6,000 miles were made, although the engine was taken out of service for light repairs at a division shop from March 14th to 16th; the cost of running repairs for this month being \$40. This engine has started off pretty well, but if the red dots on the top line, indicating failures, become too numerous, or if the engine is held out of service too long or too often, and the cost of running repairs is higher than the mileage shown would warrant, you don't have to look twice to discover it, and you have immediately before you, without going any further, pretty much all the information necessary to determine what the engine should do. If you want to know more about a certain failure or why an engine was held in, the dates which are covered furnish a ready index.

NEW LOCOMOTIVE AND CAR SHOPS AT CONCORD—BOSTON AND MAINE RAILWAY.

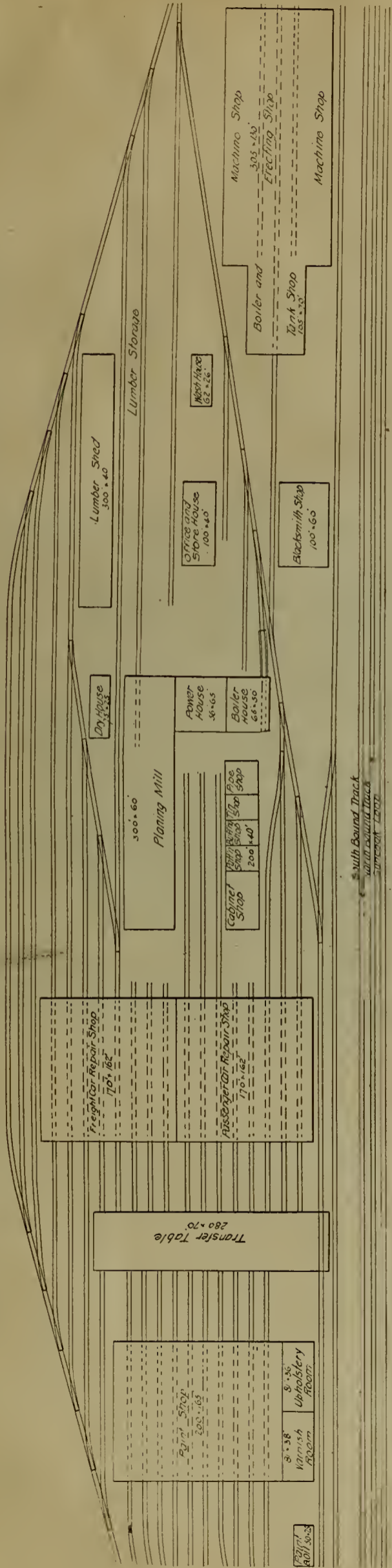

GENERAL-GROUND PLAN.

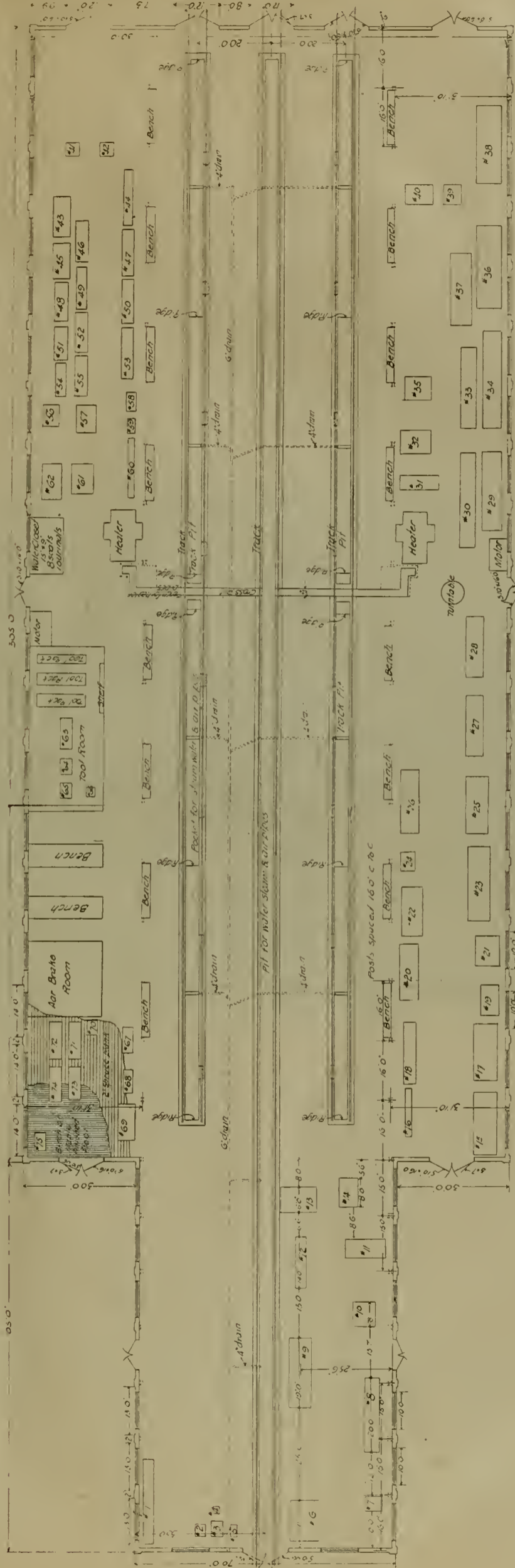

MACHINE AND ERECTING SHOP.

- KEY TO TOOL LOCATIONS—
- 1—Pipe tester
  - 2—Drill press.
  - 3—Tube welder.
  - 4—Tube welder furnace.
  - 5—Tube cutter.
  - 6—Shear.
  - 7—Punch.
  - 8—Plate planer.
  - 9—Plate rolls.
  - 10—Radial drill.
  - 11—Flanged punch.
  - 12—Clamps.

- 13—Flanging block.
- 14—Flanging block.
- 15—Car wheel lathe.
- 16—Wheel press
- 17—Car wheel lathe.
- 18—Lathe.
- 19—Car wheel borer.
- 20—Lathe.
- 21—Car wheel borer.
- 22—Lathe.
- 23—Car wheel lathe.
- 24—Grinder.
- 25—Driving wheel lathe

- 26—Driving wheel press.
- 27, 28—Driving wheel lathes.
- 29, 30—Planers.
- 31—Radial drill.
- 32—Slotter.
- 33, 34—Planers.
- 35—Slotter.
- 36, 37, 38—Planers.
- 39, 40—Shapers.
- 41, 42—Drills.
- 43 to 55 inclusive—Lathes.
- 56, 57—Boring mills.
- 58—Grinder.

- 59—Centering ring.
- 60—Speed lathe.
- 61—Drill.
- 62—S'otter.
- 63, 64, 65, 66 in the tool room are lathe, milling machine, tool grinder (Gisholt), and twist drill grinder.
- 67, 68—Bolt cutters.
- 69—Screw machine.
- 70—Drill.
- 71, 72—Brass lathes.
- 73—Speed lathe.
- 74—Fox Turret lathe.
- 75—Nut tapper.

Using the same daily sheets and allowing only five horizontal lines to each engine, we show by dots of different colors the dates and location of the washing out of each engine, of the application of metallic piston rod and valve stem packing, and of the inspection of nettings and ash pans. So that any neglect in washing out, the use of too much packing or lack of regular inspection, is readily checked.

In Fig. 2 I have shown, in a simpler way, the shopping of coaches and in general the extent of the repairs made, this by months instead of by days, as in the engine diagram. Coach 211 was given a general overhauling (indicated by a block three lines high) between March 1st and the middle of April, 1896, and was painted and varnished, the old paint being burned off (B). On January 1st, 1897, eight months after, it received light repairs, being in shop for a matter of a couple of weeks, and was varnished only. The blackened edge to the right of the blocks indicates paint and varnish, the line alone varnish only. This car was washed with soap (W) in September and May, and was again shopped for light repairs and varnished in December, 1897. Coach 213 was taken in for light repairs in April, 1897, because of being damaged in service and before its usual time, the cross hatching indicating this. Coach 214 was held in for a few days in May, 1897, for light repairs, but was not painted or varnished, only washed.

From such a chart one can obtain a very good idea in a few minutes of the probable condition of the equipment, and if a car is neglected or overlooked, attention is quickly called to that fact. It is not necessary to

BY DAILY CHARTS.

Locomotives—Shopping, cost repairs, mileage, etc. Number held at principal shops for general repairs. Estimate of cost of such repairs. Number held each week at division shops. Number turned out each week at division shops. Washing out of boilers. Metallic packing used on each engine. Inspection of nettings and ash pans.

BROOKS' LOCOMOTIVE FOR KOREA.

Last year an American firm secured from the Royal Government a concession to build a railroad in Korea, the first and only one in that country, and, notwithstanding constant political disturbances, its construction and equipment have gone steadily forward. This railroad is of the American standard gauge (4' 8 1/2") and is known as the Seoul-Chemulpo Railway, extending from Seoul, the capital of Korea, on the north, to Chemulpo, the chief seaport on the south, a distance of about 25 miles.

The Brooks Locomotive Works received the order for the four locomotives with which this railroad will be equipped and have them completed. They are of the 6-coupled side tank type with 14"x22" cylinders; 42" drivers; straight top boiler 46" in diam.; and steel fire box 54" long by 35" wide. The dimensions of this engine are appended, and our

CYLINDERS.

Cylinders, diameter.....	14x22 in. stroke
Piston rod, diameter.....	2 5/8 in.
Kind of piston rod, packing.....	Jerome
Main rod, length, center to center.....	68 1/2 in.
Steam ports, length.....	12 in.
Steam ports, width.....	1 1/8 in.
Exhaust ports, length.....	12 in.
Exhaust ports, width.....	2 1/2 in.
Bridge, width.....	1 3/4 in.

VALVES.

Valves, kind of.....	Richardson
Valves, greatest travel.....	5 1/4 in.
Valves, outside lap.....	7/8 in.
Valves, inside lap.....	3-32 in.
Valves, lead in full gear.....	

BOILER.

Boiler, type of.....	Straight top
Boiler, working steam pressure.....	140 lbs.
Boiler, material in barrel.....	Steel
Boiler, thickness of material in barrel.....	3/8 in.
Boiler, thickness of material in tube sheet.....	1/2 in.
Boiler, diameter of barrel.....	46 in.
Seams, kind of horizontal.....	Quadruple
Seams, kind of circumferential.....	Double
Crown sheet, stayed with.....	Radial stays
Dome, diameter.....	22 in.

FIREBOX.

Firebox, type.....	Deep
Firebox, length.....	54 in.



BROOKS LOCOMOTIVE FOR KOREA.

draw off any figures to determine what cars are to be shopped during the coming month, a glance down the line being sufficient. You have, too, as in the case of the engines, a permanent record of each car, as well as a record of the number of cars shopped each month. I also use the same kind of a chart for cabooses.

Of course such charts might be amplified considerably, but each man would probably prefer to develop them to suit his particular requirements. I give here a list of some of the "diagrams" which are kept in my office.

BY MONTHLY CHARTS.

Pay Rolls—In summary and detail.  
Coal—Cost per mile. Miles to 1 ton. Tons per 10,000-ton miles. Percentage of excess over allowance by divisions.

Locomotives—Number in service. Number in store. Total mileage. Total cost repairs. (Labor, Material.) Cost repairs per mile. Failures—In detail. By divisions. By classes. By engines. Total. Number of engines handled at each round-house. Cost of handling per engine. Cost of wipers and dispatchers per mile. Cost of oil and waste per mile. (Different kinds of oil.) Miles to 1 pint and 1 pound. Cost of supplies per mile. Cost of sand per mile.

Cars—Cost of repairs passenger cars and freight cars. (Labor and material.) Cost of oil per mile. Cost of waste per mile. Shopping of passenger cars. Shopping of cabooses.

Engineers—Each man's record. Oil—Good or poor. Coal—Percentage of excess over allowance. Marks or suspensions.

reproduction from a photograph affords an excellent idea of its general appearance:

GENERAL DIMENSIONS.

Name of builder.....	Description.
Name of operating road.....	Brooks' Locomotive Works
Name of operating road.....	Seoul-Chemulpo Ry. of Korea
No. and date of delivery.....	Four, December, 1897
Gauge.....	4 ft. 8 1/2 in.
Simple or compound.....	Simple
Kind of fuel to be used.....	Bituminous coal
Weight on drivers.....	Av. 65,000 lbs. Max. 67,600 lbs.
Weight on truck wheels.....	Av. 10,000 lbs. Max. 11,000 lbs.
Weight—total.....	Av. 75,000 lbs. Max. 78,600 lbs.

GENERAL DIMENSIONS.

Wheel base, total of engine.....	19 ft.
Wheel base, driving.....	12 ft. 3 in.
Length over all, engine.....	30 ft. 1 in.
Height, center of boiler above rails.....	6 ft. 2 in.
Height, stack above rails.....	11 ft. 2 1/2 in.
Heating surface, firebox.....	71.2 sq. ft.
Heating surface, tubes.....	575 sq. ft.
Heating surface, total.....	646.2 sq. ft.
Grate area.....	12.66 sq. ft.

WHEELS AND JOURNALS.

Drivers, number.....	Six
Drivers, diameter.....	42 in.
Drivers, material of centers.....	Cast iron
Truck wheels, diameter.....	28 in.
Journals, driving axle, size.....	6x7 1/4 in.
Journals, truck axle, size.....	4 1/4 x 8 in.
Main crank pin, size.....	3 3/4 x 4 in.

Firebox, width.....	35 in.
Firebox, depth, front.....	58 1/2 in.
Firebox, depth, back.....	58 1/2 in.
Firebox, material.....	Steel
Firebox, thickness of sheets.....	Sides and crown 3/4"; back, 5-16"; tube, 1/2"
Firebox, brick arch.....	On studs
Firebox, mud ring, width.....	Front, 3 1/2"; sides, 3"; back, 3"
Firebox, water space at top.....	Front, 3 1/2"; sides, 4"; back, 4"
Grate, kind of.....	Rocking
Tubes, number.....	122
Tubes, material.....	Charcoal iron
Tubes, outside diameter.....	2 in.
Tubes, thickness.....	No. 13, B. W. G.
Tubes, length.....	9 ft. 1 in.

SMOKEBOX.

Smokebox, diameter.....	49 in.
Smokebox, length from flue sheet.....	47 1/2 in.

OTHER PARTS.

Exhaust nozzle, single or double.....	Single
Exhaust, nozzle, variable or permanent.....	Permanent
Exhaust nozzle, diameter.....	4", 4 3-16", 4 3/8"
Exhaust nozzle, distance of top above center of boiler.....	13 in.
Netting, wire or plate.....	Wire
Netting, size of mesh or perforation.....	No. 12 gauge; 2 1/2 x 2 1/2" mesh.
Stack, straight or taper.....	Taper
Stack, least diameter.....	10 in.



Stack, greatest diameter.....12 3/4 in.  
 Stack, height above smokestack.....37 in.  
 Tank capacity.....960 U. S. gal.  
 Coal capacity.....1 ton

SPECIAL EQUIPMENT.

Smokebox front and door, pressed steel; sight feed lubricator, Detroit, No. 2; injectors, Hancock; brakes, steam and hand brakes on all drivers.

COMMUNICATIONS.

Locomotive Steam Gauge.

To the Editor of the Railway Master Mechanic:

Feeling that the Railway Master Mechanic offers welcome and profitable reading to many who are not in the railroad world, and as there are daily many more steam gauges being looked at and studied than are attached to locomotive boilers, I beg the space for a few exceptions which I presume to take to the manner of statement of some of the details of an article on locomotive steam gauges appearing in the February issue of your paper. I venture to take these exceptions because I feel that the author's views are not properly represented in his article, and in justice to the young and studious firemen who may read the paper as a matter of study and hoped for source of profit.

There are those who read technical publications devoted to matters wholly apart from their own special

ing up this particular detail of the paper, I must add that I have done so because further on in his notes Mr. Curtis touches very strongly on heat as affecting the reading of the gauge, and with it fastened on the head of the boiler it would be quite fair for the uninformed to ask how the gauge can be expected to be correct if so placed, and if affected by outside heat.

The author says it is possible, owing to its location, to have a locomotive steam gauge show more than twenty pounds of an error in its reading. Why stop at the statement instead of continuing with its explanation? Why whet curiosity and not gratify it? I fail to see how any such variation can be made except perhaps by the difference between placing the gauge wholly outside of the cab and thus well removed from the boiler, and securing it in metallic contact, flat against the boiler-head under a temperature of likely 350 or more degrees Fahr.

In the fourth line of the fourth paragraph of his contribution the author says, "almost every one's general experience has taught that metal becomes weaker as it gets warmer—say from fifty degrees upward." The standard dictionary defines "weak" as "insufficiently resisting stress," and if that was the author's conception of its meaning when he used the term, it makes his broad assertion of metal growing weaker as it grows warmer a highly misleading one for a knowledge seeker to read. It is a statement only limitedly within the confines of truth as expressed by scientific study and experiment, and it amounts to a flat contra-

Railroad Gazette of May 6th and 20th, 1892. In these he says that copper decreases quite regularly with increase of temperature, and at such a constant rate that the latter can be included as a factor in designing for pressure work. Gun metal, as he also shows, loses tensile strength as it becomes hotter, and phosphor bronze grows rapidly and irregularly weaker in tensile stress, resisting capacity as it absorbs heat.

Having the data from two such reliable sources—before him—showing the cupric and some alloyed metals agreeing with him, and the ferrous contradicting him—he will admit, I think, that his general assertion as to metals—concerning their characteristic under consideration—is one not to be made without qualification.

I am afraid that out of his earnestness of desire to show that a steam gauge can be injured by heat, Mr. Curtis indulges in that dexterous manipulation known as "hair-splitting" when he says that if a gauge be adjusted at 60 degrees temperature and then placed on a hot boiler where the temperature is 100 degrees (!) or more, the "hollow" tube will open more than it would when cold and thus show a seeming excess pressure.

As to a fireman being deceived by a gauge heated to 100 degrees temperature, I will venture to say that the error in over-pressure indicated by such a gauge as compared with one at 60 degrees would be only a small fraction of that general error due to the personal equation in the ordinary reading of a steam gauge graduated in divisions of five pounds each. I think that I would stand a good chance of winning a wager based on 99 degrees of all the steam boiler pressure gauges being so placed that they are heated to a point quite appreciably higher than 100 degrees Fahr., and a further small wager on their being no practical reason for considering their readings in error. I fully agree with Mr. Curtis that heat can affect the reading of a steam gauge, but at the temperature which he instances—100 degrees Fahr.—I have never observed any variation worth noticing seriously in every-day boiler work.

Since reading Mr. Curtis' "Notes" I have made two tests of the influence of heat on an ordinary 10 degree steam gauge, and I could not see any effect of the heat at a temperature of 100 degrees Fahr., but it was very marked at from 220 degrees to 225 degrees Fahr., though surely no master mechanic would allow a locomotive steam gauge to be so situated as to be heated to 225 degrees Fahr. The results of those tests while far more approximate than exhaustive, may be of value enough for you to include, and I append hereto a table thereof.

A steam gauge in normal use and at a temperature of 60 degrees Fahr. is a "rara avis," and I have noticed in locomotive cabs that in spite of the heat the steam gauges show a pretty good fellowship existing between themselves and the "pops." Of course it may be that all the steam gauges that I have so seen were calibrated for tropical cabs and hot boiler-heads.

In the last paragraph but one of your contributor's notes he says, "Short water columns are not as sure to give correct results as long ones." Bearing in mind that according to the caption of his article he refers specially to steam gauges on locomotives and that in locomotive practice there is little likelihood of having an unfavorably long water column, I would only say that I make the foregoing quotation an excuse for adding that—apart from locomotive work—if the rate of fuel consumption be governed by the reading of the gauge and not by the evidences of boiler activity at the other end of the line, then long water columns are a source of delight to the hearts of the boiler insurance companies, especially if, as in a case in mind where the gauge was in the second floor below that on which the boiler was, the reading is about twelve pounds higher than the actual pressure in the boiler, due to the added weight of the water column. There was also a gauge attached to the boiler front as usual, but as it showed so much less than its lower-level companion, it was looked upon with suspicion and as untrustworthy and was cut out, but not detached, for owing probably to a vague, guilty-conscience sort of a feeling it was always cut in again on expectation of a visit of the boiler inspector.

The concluding paragraph of the paper is, however, the most pregnant with startling interest of concern to the entire field of steam boiler feeding—locomotive, marine and stationary. The author's attention is also called to the astonishing statement contained in the last sentence but one, and its immediate and undeniable contradiction in the very next and final sentence. After referring to the fall of pressure in the fountain he says, "This may be detected by noting the boiler pressure when both injectors are working, and then shutting off both injectors at once and noting the instantaneous rise of pressure by the gauge indicator." (The italics are mine.) I have watched the steam gauges of a good many locomotives at the time of shutting off the injector, but never have I seen one indicate an instantaneous rise of pressure in the boilers on doing so.

The contradicting and closing sentence of his paper bears me out in this. It says "While the boiler pressure may rise after shutting off both injectors, it rises gradually and not instantaneously." A locomotive boiler which would allow, during the operation of its injectors, supplied by a 1 1/2 inch steam connection each, the pressure to drop so far as to show an instantaneous rise of appreciable amount upon shutting

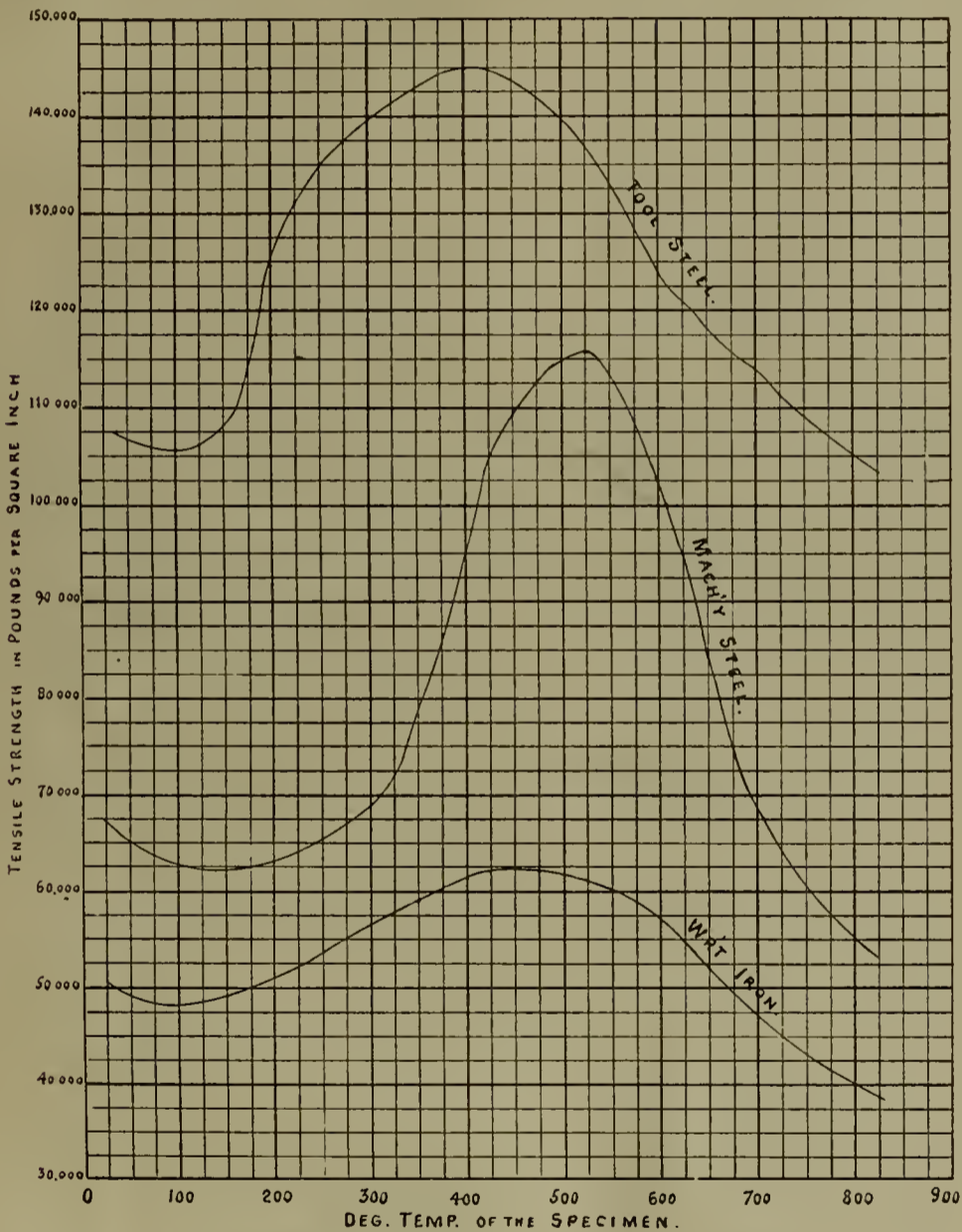

RELATION OF TEMPERATURE TO STRENGTH OF METALS (see communication from W. F. MONAGHAN).

department of the same general field, hence as intimated at the outset hereof there may be many who will read Mr. Curtis' paper on steam gauges who have never stood inside of a locomotive cab, and who thus so far as their personal observation goes, are utterly ignorant of the arrangement of its fixtures; but who are yet willing and anxious to inform themselves on these points through the reading of such articles as that of the author in question. Such, therefore, taking up "Notes on Locomotive Steam Gauges" would lead off with the idea that steam gauges on locomotives are invariably to be found on the boiler-head, whereas but a small percentage are so found; being mainly seen supported by a bracket or standard—the latter, it is true, often secured to the boiler-head, especially on engines of the design of twenty-five years ago—but the gauge itself being anywhere from eight or ten to twenty or more inches above the head of the boiler, and on most of the large and heavy locomotives of today it is from two to five feet forward of the head. To shield myself from criticism as to captiousness in tak-

dition of laboratory results; something which I hardly think your contributor willfully intended. I respectfully refer him to the report of tests made, I believe by Messrs. O. R. Wilson and R. L. Gordon in the spring of 1895, in the testing laboratory of Sibley College, and presented by Prof. R. C. Carpenter, with acknowledgement to them, as a paper at the New York, 1895, meeting of the American Society of Mechanical Engineers, and included in Vol. XVII. of the transactions of that body. The results of those tests, which were of tool steel, machinery steel, and wrought iron, were given by Prof. Carpenter in the graphic form of plotted curves and, with more comprehensive data, in the usual tabulated way. Prof. Carpenter stated that about thirty specimens of wrought iron, and about twenty-five specimens of steel were tested from 22 degrees to 825 degrees Fahr. I have thought it of sufficient general interest to add hereto a reproduction of the curves.

Further I would refer Mr. Curtis to contributions from Prof. H. Wade Hibbard to the columns of the

to resist the draft upon it of a six or seven inch dry pipe feeding two eighteen to twenty-two inch cylinders. If, as Mr. Curtis says, there are several pounds less pressure in the fountain or turret when the injectors

taining the article on locomotive steam gages, by Mr. Theo. R. Curtis, to which you direct our attention. In regard to this article we would say, that Mr. Curtis has evidently made careful observation as to the cause

if they are not properly syphoned, and it would not be out of place to also state that it is equally as necessary that steam gages must not be placed so near the boiler as to be effected by heat from the outside. Many railroads have their locomotive steam gage so applied to the boiler that there is an air space between the back of the gage and the boiler head, of from four to six inches, which is an application that gives good satisfaction, and which we would recommend. Yours truly,  
The Ashton Valve Co.,  
A. C. Ashton, Sec.-Treas.

Steam Jacketing Locomotive Cylinders.

Buffalo, N. Y., Feb. 13, 1898.

To the Editor of the Railway Master Mechanic:  
In the article about long-stroke cylinders and piston valves in your February issue, an engine is mentioned, so designed that the exhaust steam is passed around the cylinder. "steam-jacketing it most effectually."

This is a very grave error. Exhaust steam is so much cooler than the cylinder walls, that it can only carry off, and waste, heat, if it is allowed to come in contact with them. Suppose the engine in question to carry 190 pounds of steam, a not uncommon pressure in these days. Its temperature, as it enters the cylinders, would be not far from 380°, making some allowance for loss of pressure in the pipes. If the exhaust steam has 5 lbs. back pressure, its temperature would be 228°. The temperature of the cylinder walls may be assumed to be, for the sake of the argument, the means of these, say 304°. Then, the proposed "steam-jacketing," being 76° lower, and passing over the cylinder surface with a very considerable velocity, cannot but rob the cylinder of heat.

It must be remembered that 79° represents the difference in temperature between that of a summer day, quite warm enough for comfort, and a zero day in winter; and it is only a fair simile to liken the cylinder, with its jacket of exhaust steam, to a man, clothed in the very lightest of summer wear, and exposed to a blizzard.

One fact, which is well established, is often lost sight of, that the conducting power of a metallic wall separating two media of different temperatures, as, for instance, the sides of a boiler, is practically independent of its thickness; being, in fact, the same as though it were infinitely thin. There is absolutely no loss in effective heating power, if a thick firebox or boiler tube is substituted for a thin one. The choice between the two is limited to the question of first cost and durability only.

In the matter of steam cylinders, one of the good features of piston valves is, that if they are properly designed, it is possible to lead the exhaust steam directly away from the cylinder; and it is also possible to make the valve pistons themselves non-conducting, to a great degree. One of the valuable features of the Corliss valve lays in this very point; that the exhaust is not allowed to touch the cylinder after it has left it; and the Corliss engine is well-known to give better economy in the use of steam than any possible construction of engine using the ordinary slide valve. The latter, subjected, as it is, to rush of live steam on one side, and of exhaust steam on the other, the two differing in temperature from 100° to 150°, cannot but waste a very considerable quantity of heat.

Cylinders should be jacketed, beyond question; but preferably with felt, magnesia, mineral wool, or some other approved non-conductor; most certainly not with exhaust steam. Geo. B. Snow.

[We have referred the above communication to Mr. Geo. W. Cushing, the author of the article on long stroke cylinders and piston valves, alluded to. Mr. Cushing favors us with the following comment:]

Chicago, Feb. 20, 1898.

To most questions there are two sides, each of them interesting when facts are the point in view; and, with reference to exhaust steam jacketing being beneficial there are two opinions as appears by the letter of your correspondent, that you kindly referred to me. Mr. Snow reflects adversely upon my reference to a locomotive cylinder being effectually steam jacketed by the exhaust steam. This word "effectually" is a stronger expression than necessary, when the only purpose was to mention the fact of the cylinders being so jacketed; but to the ordinary mind there would seem to be benefit derived from the use of the exhaust in this way. It enters the jacket chamber at a temperature higher than that of the cylinder walls under the usual conditions of same; it is not held therein for condensation and the cooling of walls proper, but is almost as swift in its passage through as direct steam at boiler pressure would be. It also heats the outer walls of the exhaust chamber, it is true, but condensation is not troublesome and scarcely noticeable. If direct steam, at boiler pressure, was used to steam jacket, there would be a gradual condensation in, and filling up of, the chamber with water, except as it is wasted out, and steam with it also, to a certain extent to preserve circulation. This would be wasteful indeed, and possibly this may be the condition which condemns the practice.

It is not likely that exhaust steam jacketing will ever become an important matter for consideration in locomotive practice, but if your correspondent has not

TEST GAUGE.			SERVICE GAUGE.		TIME OF NOTING READINGS OF GAUGES AND OF THERMOMETER.
TEMP. AT COMMENCEMENT OF TEST.	TEMP. AT TERMINATION OF TEST.	READINGS THROUGHOUT TEST.	READINGS AT SUBJECTED TEMP. AS COMPARED WITH TEST GAUGE.	SUBJECTED TEMP.	
DEGREES FAH.	DEGREES FAH.	LBS. PER SQ. IN.	DEG. FAH.		
64	64	150.	150.0	80.0	10.10 <sup>AM</sup>
		150.	150.5	133.0	10.22
		150.	151.0	132.0	10.29
		150.	151.0	134.5	10.33
		150.	151.0	134.0	10.36
		150.	151.25	135.0	10.40
		150.	151.5	134.0	10.43
		150.	151.75	135.5	10.46
		150.	151.75	134.5	11.00
		150.	152.0	134.0	11.06
		150.	152.0	134.5	11.17
		150.	152.0	137.0	11.22
		150.	152.5	150.0	11.25
		150.	152.5	160.0	11.29
		150.	152.75	169.0	11.34
		150.	153.	178.0	11.42
		150.	153.75	191.5	11.48
		150.	154.5	201.0	12.02 <sup>PM</sup>
		150.	154.75	210.0	12.12
		150.	155.0	216.0	12.21
		150.	155.5	219.0	12.30
		150.	155.5	221.0	12.35
		150.	155.75	220.0	12.40
		150.	156.0	221.5	12.47
		150.	156.75	222.0	1.05
		150.	156.75	221.0	1.12
		150.	157.25	220.0	1.20
		150.	157.5	223.0	1.34

AVERAGE TEMP. DURING 55 MINUTES ----- 134.1  
APPARENT ERROR IN EXCESS PRESS. IN LBS. PER SQ. INCH OVER THE READING OF THE TEST GAUGE, AND DUE TO THIS TEMP. ----- 2.0  
PERCENTAGE OF THE READING OF THE TEST GAUGE ----- 1.33

AVERAGE TEMP. DURING 45 MINUTES ----- 220.9°  
APPARENT ERROR IN EXCESS PRESS. IN LBS. PER SQ. INCH OVER THE READING OF THE TEST GAUGE, AND DUE TO THIS TEMP. ----- 7.25  
PERCENTAGE OF THE READING OF THE TEST GAUGE ----- 4.83

TABLE OF RESULTS OF A TEST FOR DETERMINING THE EFFECT OF HEAT ON AN ORDINARY STEAM GAUGE. (See communication from W. F. Monaghan.)

are working than there is in the boiler at the same time it is an argument in the line of the fountain being a rather fair superheater of the steam supplied to the injectors and it is thus, maybe, furnishing them with good dry steam, a very essential requisite among others for their satisfactory operation. It suggests also a foundation too small for its intended purpose. (See the excellent paper by Mr. J. A. Bischoff, on injectors in the same issue of your journal.)

Wm. F. Monaghan, M. E.,  
Member Am. Soc. Mech. Engrs.

The Effect of Heat on Steam Gages.

Boston, Mass., Feb. 18, 1898.

To the Editor of the Railway Master Mechanic:  
We have the February number of your paper, con-

of discrepancies as found in steam gages in practice, and we can thoroughly agree with his conclusions. Our attention has been called many times to the effect of heat on steam gages, and we wish that the users of these delicate instruments, which serve so important a purpose on a steam boiler, would realize how essential it is to have all steam gages properly syphoned, so that nothing but water of a normal temperature shall fill the interior of the gage tubes; and that they would be equally as careful that the gage case and other parts are not heated up from the outside by being placed too close to the boiler itself, that is without a suitable air space, or other means of preventing the heat from radiation effecting it. Like all other manufacturers in our line, we emphasize in our catalogue and other printed matter, the fact that we will not guarantee our steam gages to be accurate and reliable

himself experimented with the exhaust in this connection he is no more certain of the result than myself—and I hold the same opinion as before.

At times, theory and practice alike rely upon evidences which appear inconclusive to a practical experimenter like Professor Goss of Purdue University. For instance, Professor Goss has facilities which develop the practical side of theories, and it is suggested that the professor be asked to consider the matter as stated.

The writer is not an advocate of steam or exhaust steam jacketing, and has not practical experience to warrant it, except the short one, as in the case first stated. I think experience in the use of arbestos coverings of steam cylinders, properly applied, together with the covering with same of the steam chests and covers, and the filling up of all exposed cavities in cylinders, with asbestos, proves it to represent good practice. This method may safely be said to consume the heat, on a practical and economical basis.

Geo. W. Cushing.

**The Bell Front End on the Great Northern Mastodon.**

To the Editor of the Railway Master Mechanic:

In my paper on "Long stroke cylinders and piston valves," in the February issue of the Railway Master Mechanic, there was a passing reference made to the front end and spark arrester arrangement designed by

give room for cinder pocket in front of the cylinder saddle."

This position of the committee appears to be sustained in the use of the Bell front, and its later design dispenses with the cinder pocket. It also retains in use the present standard of straight stack. Some other roads using this front are the Baltimore & Ohio on mountain and other engines; the Wisconsin Central, on old and the new engines, now building, and on the Illinois Central on its fast passenger engines. I may add that the writer has no personal interest in the matter whatever.

Geo. W. Cushing.

**Cost of Oiling Cars.**

To the Editor of the Railway Master Mechanic.

The cost of lubricating oil used on one of the large trunk lines forms an item of considerable expense, and a saving of only a fraction of a pint per car oiled, amounts to thousands of gallons in a year, and represents hundreds of dollars in expenses.

If the same interest was taken in this matter that is exhibited in the operation of the locomotives, much useful information would be gained and a large reduction effected in the cost of operation of the cars, but on the majority of railroads, this matter is left in the hands of the inspectors, or men whose duty it is to oil the trains, and very little attention is paid to it by the officers in charge, as long as the cars get over the road without any trouble or delay. Occasionally some objection is made to the increase in the amount of oil used, but the excuse is made that more cars are

When the question was first proposed to the men they were inclined to object, on the ground that they would be responsible for any increase in hot boxes, urging that it was on this account that more oil was used than was required; but after a trial of almost twelve months, it is demonstrated that a still further reduction can be made, which is now being carried into effect.

When it is noted that this is only one of five or six division points, on one line, where cars are oiled, it shows the amount of saving that could be effected, if the same attention was given the matter on all roads.

It is undoubtedly a fact that a majority of the roads are using from twenty-five to fifty per cent more lubricating oil than is required, the surplus being distributed over the face of the wheels and roadbed, and if a competent man were detailed to look after this matter and devote his entire time to the different points on the line, where oiling is done, it would result in saving several times his salary every year.

Car Builder.

**BUSINESS PROBLEMS OF THE MOTIVE POWER DEPARTMENT.\***

BY ROBERT QUAYLE.

To many of you, who have for several years been studying various branches of engineering and fitting yourselves for battling successfully with the many technical problems that are sure to confront you in the practice of your chosen professions it may appear as if the technical problems requiring solution by those in charge of motive power, are more numerous, if not more important, than the business problems they are called upon to solve. That this is not the case will be clear upon proper reflection. You have doubtless learned, under the excellent practical instruction you have received at this university, that every engineering question has its commercial and business side; and the importance of always seeing this side and giving it due prominence will be impressed upon you more and more as you add to your experience in the practice of your profession. In fact every situation or condition of affairs that requires the services of the engineer, calls for the production by him of structures or mechanisms that will not only meet the requirements of the situation, but will do it with a minimum expenditure of capital, or will give the greatest returns from the investment. The successful engineer is he whose judgment is so trained that the capital of those who depend upon it will be wisely and safely invested. He must not only answer such questions as "Can this or that be done," and "How can it best be done," but he must give equally reliable answers to such questions as "Will it pay to do it?" Thus, the rule is that his engineering problems are closely interwoven with considerations of a commercial nature. The conduct of a motive power department of a large railroad system forms no exception to this rule. The end for which the department was created is of course that of keeping the wheels turning, but as one of many it is necessary to make its work fit into the needs of the others, and to so conduct its own affairs as to bring them in harmony with the aims and resources of the organization as a whole. This might properly be designated as the grand business problem of the motive power department.

**SOME ITEMS OF EXPENSE.**

Before turning to the problems within the department it may be well to give some idea of its expenses from which to judge of the magnitude of its problems. The average cost of locomotives may be placed at \$9,000, while the average capital expenditure per locomotive for roundhouses, shops, tools, etc., is in the neighborhood of \$5,000. Thus each locomotive and the equipment necessary to take care of it represents an approximate expenditure of \$14,000.

We will assume that an engine runs 26 miles to a ton of coal and makes 36,000 miles per year; then the cost of fuel per annum, at an average of \$1.75 per ton, will be \$2,423. The wages of the engineer and fireman will average about 6.2 cents per mile, and all round-house labor will average about 1.4 cents per mile, or a total for labor of 7.6 cents a mile, or \$2,736 a year. The oil and waste will cost about 0.2 of a cent a mile, or \$72 a year. The repairs and supplies will cost approximately 4 cents a mile, or a total of \$1,440 a year. The cost of water we will estimate 0.2 cents a mile, or \$72 a year; we thus find the several items of "cost of operation" to aggregate \$6,743, exclusive of all interest charges on capital employed.

It is not unusual for large railroad systems to possess 500 locomotives and quite a number of them own more than 1,000. From the above figures it will be seen that the operation of 500 locomotives calls for an average expenditure, through the mechanical department, of \$3,371,500, and for 1,000 engines the sum becomes \$6,743,000 per year. It is therefore needless to say that in the expenditure of such large sums as these and the treatment of a portion of the company's business so important and having such an important bearing on its interests, every problem, no matter what its character, has its business side as dis-

\*A lecture given to the students of Purdue University.

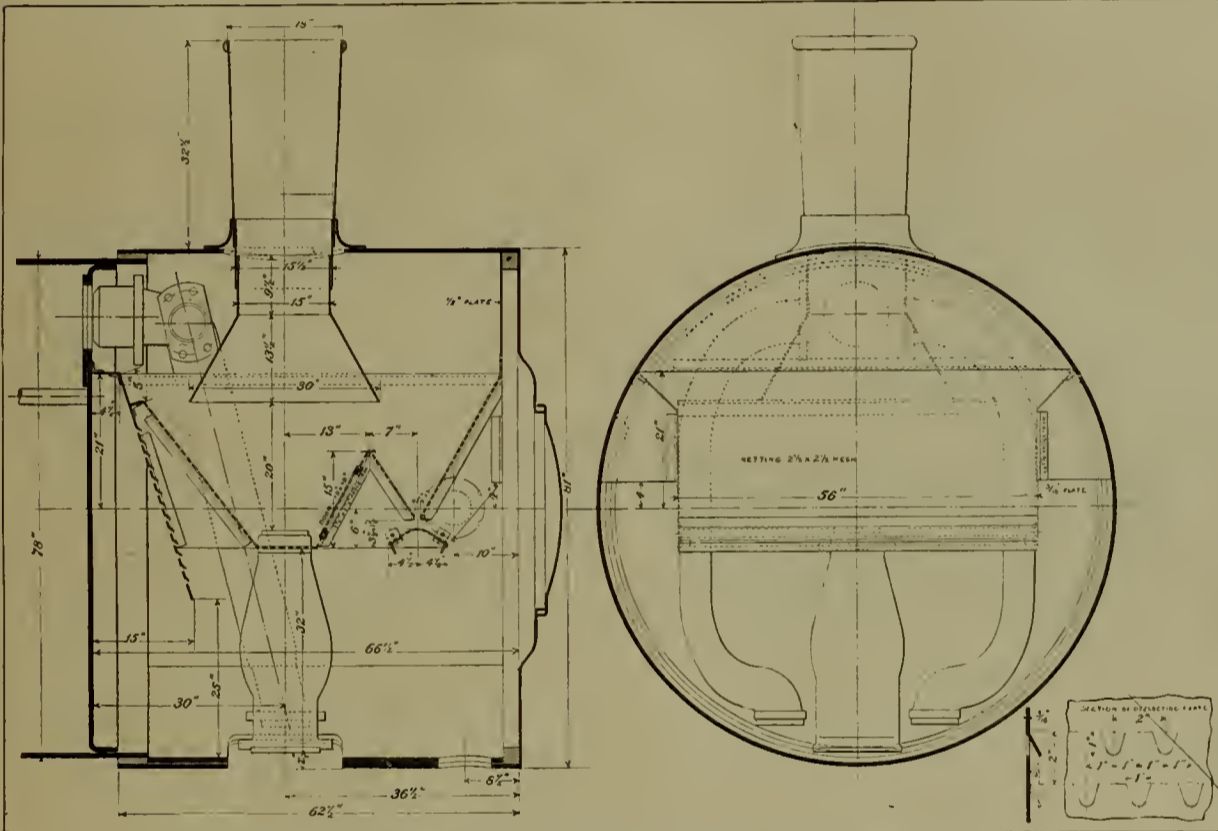

BELL FRONT END ON THE GREAT NORTHERN MASTODON.

J. Snowden Bell of Pittsburg, which is used on the new engines with piston valves on the Great Northern Railway.

I have received some questioning inquiries since the paper appeared as above; reference being made to an illustration in Locomotive Engineering of February, which shows a long extension front and the usual netting arrangement—not the Bell design—the design shown being stated to be the standard design of the Great Northern Railway.

It is not unlikely that Engineering is correct. Roads frequently depart from standard methods, in special instances, and in the case referred to the Great Northern did so and I desire to verify my statements. Accordingly I have procured the means of showing the actual design of front as applied to the engines referred to and hand you a drawing of same. Those at all familiar with the Bell arrangement will notice its adaptation.

Vice-President R. J. Gross of the Brooks Locomotive Works, the builders of engines, writing to a friend, corroborates this and says further: "The reports from the Great Northern regarding the steaming qualities of these engines are very encouraging as the engine went into service without a single change in the exhaust nozzles, netting or position of diaphragm."

The Bell design dispenses with an extension and is in line with the statement of the committee as exhaust and steam passages in its report at the Master Mechanics' Association convention of 1894, which reported in this convention as follows: "An increase in the length of the smoke box over and above that necessary to get in a cinder pocket in front of the cylinder is unnecessary and undesirable as the long smoke box greatly decreases vacuum. Sufficient area of netting can be put into a smoke box which is long enough to

being handled and the matter is dropped, although whenever there is a reduction in the amount of oil used, it is seldom ever proportional to the reduction in the number of cars handled, as shown by the following statement:

Month.	1896.			1897.		
	Total cars oiled.	Gallons of oil used.	Ave. pints per car.	Total cars oiled.	Gallons of oil used.	Ave. pints per car.
Jan ...	10,164	2,050	1.61 <sup>s</sup>	9,901	1,750	1.41 <sup>s</sup>
Feb ...	9,040	1,800	1.59 <sup>s</sup>	9,307	1,700	1.46 <sup>s</sup>
Mar ...	9,688	2,050	1.69 <sup>s</sup>	10,264	1,400	1.09 <sup>s</sup>
Apr ...	8,606	2,000	1.85 <sup>s</sup>	10,056	1,150	.91 <sup>s</sup>
May ..	10,798	2,350	1.64 <sup>s</sup>	11,304	1,850	1.30 <sup>s</sup>
June ..	10,676	2,000	1.49 <sup>s</sup>	10,116	1,250	.98 <sup>s</sup>
July ...	9,291	1,650	1.42 <sup>s</sup>	9,901	1,300	1.05 <sup>s</sup>
Aug ...	7,174	1,700	1.89 <sup>s</sup>	10,323	1,250	.96 <sup>s</sup>
Sept. ..	9,244	1,650	1.42 <sup>s</sup>	11,296	1,100	.77 <sup>s</sup>
Oct. ...	13,082	1,700	1.03 <sup>s</sup>	13,146	1,300	.79 <sup>s</sup>
Nov ...	12,458	1,750	1.12 <sup>s</sup>	13,455	1,575	.93 <sup>s</sup>
Dec ...	11,389	1,500	1.05 <sup>s</sup>	11,803	1,625	1.10 <sup>s</sup>
Total.	121,610	22,170	1.45 <sup>s</sup>	130,872	17,250	1.05 <sup>s</sup>

A careful study of the above report (which gives the figures at a certain division point) shows, apparently, a most unaccountable variation in the average amount of oil used, per car, in the different months, although an investigation of the traffic during the year would afford a partial solution of the question.

A very noticeable feature of the above report is the reduction in the amount of oil used per car in 1897 over the previous year—a saving of .404 pints per car, amounting to 6,609 gallons for the year—although no action was taken to reduce the quantity of oil used until the middle of March. At that time a systematic effort was made to reduce the quantity of oil, per car, and the results were very satisfactory, as shown, and a still further reduction will be made during the coming year, as the men have become interested in the matter and are discussing it among themselves.

tinguished from its narrower or purely technical nature.

THE LOCOMOTIVE TO BE TREATED AS A TOOL—  
NOT AS A HEAT MOTOR.

Many students of the steam engine are interested in the performance of the locomotive as a heat motor and peruse carefully the figures for the coal and water consumption obtained by elaborate tests, and are gratified to note the economy obtained as the result of gradual improvement in design. The motive power official may possess his share of sentiment, and certainly should be alive to all improvements that will increase the economy of the locomotive as a heat engine, but he must also look upon his motive power from a far more business-like standpoint. He must consider the locomotive as a machine—a tool created for a purpose—representing a large investment of capital and costing annually a considerable sum for its operation, and must be deeply concerned in making it give the largest possible return to the company. If to attain this end he must violate, in the construction or operation of the engine, principles which he knows tend toward economy of water and fuel, it is his business to do it. And I have no hesitation in saying that to the carrying out of this business-like policy are due some features of locomotive practice that are sometimes condemned by those who look upon the subject entirely from the standpoint of economy in fuel.

ENGINE RATING.

Perhaps I can best illustrate this business problem by a comparison which every motive power official has had to make at some time in connection with the rating of his engine. The tests that have been made upon the locomotive in the laboratory of Purdue University demonstrate that the most economical point of cut-off is between one-quarter and one-third of the stroke. Other tests made on the same plant show that as the locomotive boiler is forced and the rate of combustion increased, the rate of evaporation falls off rapidly. The conclusion is therefore warranted that with a given speed a cut-off later than one-third of the stroke will result in a loss of economy, both in the boiler and the cylinders. The work of the engine varies so much with the grades that we cannot expect to run at a uniform rate of cut-off, but is it economy to endeavor to give the locomotive such a load that it will average one-quarter to one-third cut-off?

Suppose a 19-inch engine in freight service on a hilly division, and that under a limitation of the average cut-off to one-third, it can haul over the division 600 tons, exclusive of its own weight and that of the way car. Let us further assume that if the engine is worked to its utmost capacity on the ruling grades (even if by so doing we must run it for many miles at one-half to full stroke), we shall be able to haul 750 tons. The train and engine crew's wages will amount to about 13.2 cents a mile, or \$13.20 per one hundred miles. When hauling the heavier train we are getting 25 per cent. more tonnage over the division for the same cost in wages, and thereby effecting a saving of \$3.30 for each hundred miles the 750 tons are hauled. This a clear gain in operating expenses. Now, let us look at the actual consumption of fuel and, in doing this we must bear in mind that while our nominal weights of trains are 600 tons and 750 tons, respectively, the real weights (allowing 100 tons for the engine and tender, and 15 tons for the way car) are 715 and 865 tons respectively. Evidently the weights of the engine, tender and way car form a fixed quantity in the calculation and the heavier the train the less the percentage of the total work of the engine needed to overcome their resistance, and the internal resistance of the engine. Evidently the coal consumption in our comparison should be figured on the basis of the tonnage of the cars and their contents only, for upon this are based the earnings of the train. For the 600-ton train the coal consumption may be taken at 17 pounds of coal per hundred ton-miles, or 10,200 pounds to haul the train one hundred miles. For the 750-ton train the consumption per hundred ton-miles will be about 1½ pounds less, or say 15.5 pounds per hundred ton-miles. In other words the lesser percentage of the total work of the engine expended upon itself, its tender and the way car, more than offsets the increased consumption of coal per indicated horse power. The total consumption for the 750 tons hauled one hundred miles will be about 11,625 pounds. Thus while the total consumption of coal per trip is greater for the heavier train the consumption per hundred ton-miles is less. Consequently the fuel bill to haul three thousand tons of cars and contents will be less if it is taken over the road in four trains of 750 tons instead of five trains of 600 tons. So we have saved money in both wages and fuel per hundred ton-miles. But the question is broader still. Evidently fewer engines, resulting in a lesser investment, are required; furthermore, while the cost of repairs per mile run by the engine may be greater, the cost per hundred ton-miles of train hauled will be less. Again, the fewer engines will mean a smaller investment in round-houses, shops, machinery, etc., and last, but not least, the operating expenses will be reduced in more ways than train crew wages, and the liability of accident will be lessened by the fewer number of trains. Thus the broader the light in which this question is viewed the greater the economy of working the locomotive beyond

the point of maximum economy per indicated horse power.

That this view, of this business problem, is correct will be acceded to by every motive power official. The situation may appear to you to be paradoxical, particularly in regard to the item of fuel, but that coal can be saved by loading an engine heavily we have proof of daily. The road with which the writer is connected keeps an individual coal record, by which the consumption of coal per hundred ton-miles by each engine is recorded. In a group of men in comparable freight service on one division the best performance, in November last, was 15.9 pounds per hundred ton-miles, the engineer having an average train of 853 tons. The poorest record was 28.7 pounds, but the average train was only 378 tons. Of course there are differences of engines (which was true in this case), but all our coal accounts support the statement that, other things being equal, the heavier the train, the less the consumption per hundred ton-miles. The limit to this rule is not reached before the engine is so overloaded that the required time cannot be made; so evident is this to our engineers that they are anxious to haul the heaviest trains of which their engines are capable, as by this means only will their records compare favorably with others in the same class of work.

This same mode of reasoning, by which the work of the engine is viewed by its effect upon the net cost of hauling tonnage rather than its economy in fuel per horse power, must apply to other questions involved in locomotive construction and operation. On this basis the size of locomotives has been constantly increasing and will continue to increase. Anything which adds to the economy of performance but limits the amount of work that can be obtained from the engine, either by reducing the tonnage it can haul per trip or reducing the mileage it can make per year, cannot hope to succeed. If a complicated valve gear would save five or ten per cent. in fuel, but would cause the engine to miss a trip occasionally because of repairs necessary to the mechanism, the loss of the service of the engine to the company in busy seasons would possibly more than offset the saving in fuel. On the other hand, simple, strong, and reliable construction of the locomotive, facilities for quickly repairing it, and everything that will add to its useful mileage per year, is worthy of careful study.

SOME SHOP PROBLEMS.

In connection with the shops and the work done in them there are numerous problems. It is not given to every superintendent of motive power to locate and build up a great plant that shall meet the company's needs.

As most of our large railroad systems have reached their present size by the consolidation and absorption of smaller lines, each of which, when independent, had shops of its own, it is not surprising to find a system provided with many shops, more or less completely equipped for doing the work of general repairs, and yet not one of them with all the facilities for doing work cheaply and on a large scale. This situation presents another business problem. The round-houses alone may have been originally located with reference to the needs of the short lines now consolidated into the larger system, and with the practice of having our locomotive runs average but little more than one hundred miles, which prevailed until recent years, these houses may all be in use. Again we have a business problem before us. Every such point involves certain expenditures for superintendence, etc., and the smaller the number of locomotives handled at a given point the higher the ratio of these expenditures to the total outlay. Then the cost of dispatching and round-house labor is not dependent upon the length of the run the locomotive has made, but is as great for a trip of one hundred miles as it is for two hundred miles. Consequently where division terminals can be so changed as to give the locomotives longer runs, round-houses can be closed, resulting in a considerable reduction in the amount of labor required to handle locomotives at terminals, as well as a material reduction in the cost of the labor remaining to be done in the houses retained. Another advantage gained is the greater mileage that can be obtained from locomotives when the runs are lengthened.

If we find the number and equipment of the shops to be as already indicated a change will be necessary, if the cost of repairs is to be reduced to a minimum. You will remember that we assumed the repairs would cost four cents per mile. That amounts to \$1,440 per locomotive per annum, or \$1,440,000 per one thousand locomotives. If we can reduce the figure by ½ cent per mile the cost per annum will be reduced by \$180,000. To effect such a reduction we must have improved machinery and up-to-date methods. But much of this machinery, if installed in a small shop, would be idle most of the time; so, in many cases, it might not pay to purchase new machinery unless more work can be found for it. By concentrating the heavy work at a few places the maximum economy can be obtained with the minimum capital invested in tools. The introduction of improved machinery and methods must go hand in hand with a concentration of the class or classes of work affected thereby. Nothing is more certain than the need of modern methods and first-class machinery in railroad shops; from this it follows that concentration of work must be accomplished, at least to the extent of keeping modern machinery properly employed.

This leads us to turn our attention to the small shops on the various divisions with a view to deciding how much of the work performed in them can be profitably transferred to the larger and better equipped shops. We may find that with proper round-house facilities for making the running repairs, some of them can be closed entirely. In such cases we gain not only the benefit of a lower cost of the work thus transferred to a better equipped shop, but we save in such items as light, heat, power, superintendence, etc. As superintendence itself is a large item, amounting to about ten per cent. of the total expenses of the department, the saving in this direction is not inconsiderable. There will still remain, however, numerous shops that must be maintained and in which certain classes of repairs can be as cheaply done as in the main shops. It will be found economical, nevertheless, to take from them the heaviest classes of repair work, and also to relieve them of the manufacturing of much of the standard materials. The main shops should undertake to make on a large scale as many of the new parts required in repairs over the entire system as the conditions will admit of, and this work should be done upon a manufacturing basis, so far as practicable. By this means the cost is reduced and there is every incentive to keep on cheapening the work and raising the quality of it by special and ingenious methods.

To carry out this policy, two things are necessary, a standardizing of the parts of the various locomotives owned by the company, and liberal appropriations for the machinery needed in the work.

THE NEED AND VALUE OF STANDARDIZING.

To show the need that may exist for standardizing and what can be accomplished, I will quote a few of the results obtained along this line in the motive power department with which I am connected. We have reduced to one or two sizes most of our cocks and valves, oil cups, injector cheeks, glands and all other brass work and small parts. At one time we had 113 different kinds of cabs on the 1,010 engines owned by the company; now the number has been reduced to nine. Pilots at one time were built of 15 different heights; now there are but three. The number of kinds and sizes of smoke stacks have been reduced from legion to four. Two patterns of exhaust pipes have replaced 45 old ones. Ten crosshead patterns take the place of 20 formerly used. Three standard eccentrics take the place of 11 needed heretofore. Sixteen cylinder-head castings and seven cylinder-head patterns have been discarded, also six steam chests and casings. Six standard wheel centers now take the place of 22 formerly used. And so I might go through the entire list, but those already mentioned are enough to indicate the great saving that can be accomplished both in the stocks carried and the cost of production. Not a week passes without seeing more of this work accomplished, and yet in it all one must be constantly on the alert for improvements and must not hold these standards too sacred. They have to be discarded occasionally if we are to profit by our own experience and that of others.

THE QUESTION OF REBUILDING.

Some roads do nothing but repair work in their shops, but a few undertake to build quite a number of their own engines. Rebuilding of locomotives is carried on to some extent in nearly every railroad shop. Where to draw the line in rebuilding it is difficult to determine. By this term I do not mean the making of extensive repairs and yet retaining the original design. Most roads find themselves possessed of engines of moderate size, provided with boilers much too small for the cylinders and carrying a low steam pressure. If these engines were rebuilt and given new boilers the tractive weight and power would be largely increased by the larger boiler and higher steam pressure. Whether it is advisable to do this depends upon the service the rebuilt engines are intended for. Perhaps, I can best illustrate the manner in which this matter should be viewed by taking actual cases. A road needs for its passenger service an engine, the equivalent in power of a 17-in. engine carrying 180 lbs. of steam. Its modern power is all large and the 17-in. and 18-in. engines owned by it will not do the work because the boilers are too small and they only carry 140 to 150 lbs. steam pressure. To rebuild one of these 17-in. engines, giving it a new boiler, will cost, say, \$4,500. I believe it will pay to do it, if the machinery is heavy enough for the higher pressure, as a new engine for the service required will cost about \$8,000. We save not only the difference in the cost, but we have one less small engine on our hands. But suppose we expect to use these rebuilt engines in freight service and have no particular place for them, but only contemplate increasing their capacity by the rebuilding; we would gain about 20 per cent. in power by the change. If the tractive power of the old engine be expressed by the number 100, then three engines rebuilt would have a total tractive power of 360. The cost of rebuilding the three engines would be \$13,500. Now, if we leave the old engines as they are and spend \$11,500 of this money in purchasing a heavy modern freight engine, we will be able to get one with a tractive power represented by 175; and we would then have four engines (three old and one new) with a combined tractive power represented by 475, or an average of 118.75 per engine. If we should scrap one of the 17-in. engines we would have three engines with a tractive power of 375 or an average of 125. Thus we find that for \$2,000 less money we can, by purchasing new power, and keeping all our power,

get almost exactly the same average tractive power as by rebuilding, and that if we would scrap one old engine for each new one purchased, the average tractive power of our engines would be considerably increased over what we could obtain by rebuilding. Evidently the figures are against rebuilding except where the rebuilt engines will fit into some particular place, generally in passenger service.

**THE NEED OF THOROUGH ORGANIZATION.**

I think I have made it evident that, to successfully carry on a business as large as we have been considering, a complete and thorough organization is necessary. The peculiar character of the work, involving shop management on the one hand and the control of a large body of men and the movement of many locomotives on the other, maintenance of the locomotives already owned and the designing of new ones, and the necessity of carrying on some of this work at points widely separated from each other, are all arguments against the possibility of any one man giving the details of this work his personal supervision. And to trust these details to others, a unity of purpose and practice is required. The business at each point must be conducted as a part of the great whole and not on independent lines. Improved methods or designs worked out at one point should become the practice at all others, if capable of more than a local application; in this manner only can advantage be taken of the ability and ingenuity of those in charge at each point. Without this unity, standards would soon be disregarded and would be of little value because they would not be based upon the experience of the whole department. A successful organization must not only assign to each person in it certain responsibilities and duties, but it must be of such a character as to utilize the best work of each one. By giving to all as much of a voice in shaping the policies of the department as is consistent with the responsibility which must rest with the head of the department, the best results will be obtained. If the men in charge at the various offices of a large department are asked to carry out instructions issued from headquarters without being consulted as to the effect of such instructions upon their work, the faithfulness with which they may carry out orders will never compensate for the loss to the department of the judgment and experience of these men, and the free expression of opinion which should prevail. I can assure you that, after the selection of capable men to fill the various positions of responsibility, an organization that will call out the hearty co-operation of each and every one of them is essential to the success of the work.

Co-operation, however, should not be confined to those in official positions. The further this spirit of co-operation can extend into the rank and file of the department the better it is for the company, its officers and the men themselves. There is a wonderful amount of loyalty on the part of the men towards a great railroad corporation that at all endeavors to treat them justly, and fortunate is the company that wins that loyalty. Its value cannot be computed. Many corporations and many officials possess it, and they have won it without yielding any of their own rights to the men, but simply by according them justice at all times. We need to bear in mind constantly that our employes are men, and that a large percentage of them are manly men and should be treated as such. With this thought directing our dealings with them we cherish those much-to-be-desired relations between employer and employe, that conserve the interests of both.

**THE VALUE OF STATISTICS.**

Statistics properly kept are of great value. By their use the business of the department can be grasped in its entirety. But in order that they should not mislead, they must not only be accurate, but must be on the right basis. In the past nearly all of the statistical work of the department has been computed on the engine-mile basis. In many respects this is most undesirable, as the engine-mile is far from being a constant unit. The ton-mile is a much better basis for much of our statistical work. Already we have placed all our coal records on this basis and it is probably only a question of time when repairs and supplies will be computed in like manner. The importance of this matter is nicely illustrated in our coal records. On the engine-mile basis the engineer who hauled the lightest train made the finest showing, other things being equal. On the ton-mile basis the man who hauls the heaviest train may expect to have the best record. Thus we furnish an incentive to actual economy of operation, instead of putting a premium on extravagance. Furthermore, if we had not considered the ton-miles we should not have seen any economy in fuel in our 750-ton train as compared with a 600-ton train, in our example of engine rating. The value of the ton-mile statistics is also illustrated by the records heavy modern power is making on many roads. When these engines are first put in service the men find they burn a large amount of coal per mile run, and use more oil than the smaller engines. Computing their fuel, supplies and repairs on the ton-mile basis, however, the performance is seen to be a wonderful improvement over the smaller engines, and fully justifies their use on divisions whose business is heavy enough to properly utilize them. It will be clear upon reflection that the statistics on the ton-mile basis would determine the true cost for a unit of work, and furthermore as this unit is also a fairly accurate measure of the value of the service

rendered the company, we are able at all times to determine with a fair degree of accuracy the cost of the locomotive performance per unit of revenue producing service.

**CONCLUSION.**

The business problems of the motive power department are so numerous, that it would have been impossible, in the time at my disposal, to have touched even lightly upon them all. These problems are not new, and in the near future some of them may cease to exist, their place being taken by others brought about by new conditions and the rapid progress being made in economic railroad operation. The tendency of passenger and freight rates is steadily downward, and that the railroads may live on the reduced rates, the cost of operation must decrease likewise. The motive power department must contribute its share to the reduction of expenses, and must do it by giving careful attention to its business problems.

**THE CROSBY THERMOSTATIC GAGE.**

In our last issue we had an article on locomotive steam gages, wherein inaccuracies of gages caused by heat were dwelt upon. The Crosby Steam Gage and Valve Company of Boston, noting the article, sends us a description of its thermostatic water-back gage, which was designed especially to meet the troubles to which allusion was made. The trouble is, as was set forth in the article, that the steam gage, when in use, is on account of its location so heated that its parts expand to such an extent that it will make wrong records of pressures. In such case the parts which materially affect the



**THE CROSBY THERMOSTATIC GAUGE.**

correct operation of the gage are tube springs. It occurs thus: The tube springs having been tested and adjusted to a certain movement under pressure in the ordinary temperature of the factory or where it takes place, will when the same are heated in use to a high temperature, lengthen by expansion to such an extent that, when they are subjected to the same pressure, their free ends will move through a larger arc than when they were tested. This movement, multiplied by the ordinary mechanism of a steam gage for transmitting it, causes this increased pressure to appear upon the dial. In such a heated condition of the tube springs, the error produced is sometimes considerable, being several per cent greater than the true pressure, thus deceiving the user of steam into the belief that he is getting a less result in work, from the indicated pressure than he ought.

This error can be corrected by suitable mechanism in the steam gage; and the Crosby Company has produced such an one, which by removal of the dial is internally shown by the accompanying cut. In the ordinary steam gage, the bar which transmits the movement of the free ends of its tube springs is made of a homogeneous metal, and when the tube springs are affected under heat, as above stated, it transmits the increased movement just in the same way that it would transmit the intended or designed movement when the tube springs are cold. Thus the error arises. In the improved gage here shown, this bar is made of brass and steel brazed together, forming a thermal bar C, D, so that, under the influence of high temperatures, it will compensate for the expansion or lengthening of the tube springs and their greater movement

thereby under pressure, by retarding simultaneously the motion of the index which records such movement on the dial. The action of this thermal bar is, that its end remote from that where it is attached to the tube springs will droop, or deflect, or move oppositely to the tube springs on account of the action of the temperature upon the two metals composing it, as is commonly understood. This opposite movement retards the index proportionately to the lengthening of the tube springs, as they are both influenced by the same temperature, and thus compels it to keep back to the notation of pressure on the dial where it correctly should be.

In addition to this thermal bar, this gage has a chamber, A, so constructed that when filled with water or other liquid it not only supplies the Bourdon tube springs B, B, connected to it with all that is required, but serves to equalize the temperature about them. This is important. For unless the tube springs are subjected to a heat greater than 212° Fahr., they do not set when in use; and as it is impossible as made, under ordinary conditions of use, for heat to be transmitted by conduction to such an extent they are secure from this danger. This chamber is located in the gage case so that it has its connection to it and with the boiler at the bottom. Attached to it are the tube springs, B, B, the index mechanism, E, and the dial, the latter upon the bosses F; and all are independent of the case and are free from any influence of it under heat, excepting at its immediate point of attachment, which is unimportant.

**STEEL VS. WOODEN CARS.**

**An Estimate of Relative Costs and Economies.**

The importance of saving of dead weight in cars is a subject that has frequently been commented upon and admits of little or no question. How to show the value of this saving, however, in actual dollars and cents, has been found most difficult. The Schoen Pressed Steel Company has prepared a statement showing this, as related to the savings effected by the use of steel cars. The Schoen company believes this statement, which we append, to be approximately correct. Combined with it is a statement showing the saving in cost and maintenance of a modern steel car, as built by the Schoen Pressed Steel Company, as compared with a wooden car. For the sake of easy reference the statement is divided into two parts, viz.: First, saving in cost and maintenance. Second, gain due to saving of dead weight.

**SAVING IN COST AND MAINTENANCE.**

Comparison of cost between 30-ton wooden car and 50-ton modern steel car. The comparison includes interest and cost of maintenance for the life of each car respectively. The cost of repairs to the wooden car is averaged at \$40 per year throughout its life of say 15 years and of the steel car at \$20 per year throughout its life of say 30 years.

Wooden Car.		Modern Steel Car.	
Cost, new . . . . .	525.00	Cost, new . . . . .	810.00
Interest, 15 yrs. at 6% . . . . .	472.50	Interest, 30 yrs. at 6% . . . . .	1458.00
Repairs. \$40 per year, 15 years . . . . .	600.00	Repairs. \$20 per year, 30 years . . . . .	600.00
		Cost of steel car	
Cost for 15 yrs.	\$1597.50	for 30 yrs. . . . .	\$2868.00
Double this amount and you have the cost of wooden car for 30 years . . . . .	\$3195.00	This means a cost of \$95.60 per year during the life of the steel car, or \$1.91 cost per year per ton carrying capacity.	
		This means a cost of \$106.50 per year during the life of the wooden car, or \$3.55 cost per year per ton carrying capacity.	

Difference in cost per year per ton carrying capacity in favor of steel cars \$1.64, which is equal to 46.2 per cent. If this \$1.64 be multiplied by 50 tons—capacity of steel car—it shows a saving per steel car per year of . . . . . \$ 82 At \$82.00 per steel car per year, 500 steel cars will save per year . . . . . 41,000 At \$41,000 saved per year, 500 steel cars for 30 years will show a total saving of \$1,230,000

**GAIN DUE TO SAVING OF DEAD WEIGHT.**

Assuming that train loads of 1,500 tons of paying freight are hauled and that the wooden car weighs 16½ tons and the steel car 17 tons.

To haul 1,500 tons, 50 wooden cars are required, weighing . . . . . \$25 tons  
 To haul 1,500 tons, 30 steel cars are required, weighing . . . . . 510 tons

Dead weight saved per train load—Factor of steel cars . . . . . 315 tons  
 If 500 steel cars are used, it will give 16½ full train loads, which, multiplied by 315 (tons of dead weight saved per train), gives 5,250 tons of paying freight gained for each run of the 500 steel cars.

In estimating the actual cost to a railroad company for hauling ore to, and coal from, Pittsburg to the Lakes, many difficulties are met with. We have assumed, however, for the purpose of this comparison, a cost of 15 cents per ton in each class of cars, 5,250 tons of paying freight gained for each run of 500 steel cars at 15c per ton, equal . . . . . \$ 787.50  
 If the cars make 30 runs per year this gain is \$787.50 × 30, equal . . . . . 23,625.00  
 30 round trips (equal to 60 runs one way), per year, \$23,625 × 2, equal . . . . . 47,250.00  
 Gain in 30 years due to saving of dead weight alone \$47,250 × 30, equal . . . . . 1,417,500.00

**RECAPITULATION.**

Saving in cost and maintenance, statement No. 1 . . . . . \$1,230,000.00  
 Gain due to saving of dead weight alone, statement No. 2 . . . . . 1,417,500.00

Total saving effected by 500 steel cars in 30 years . . . . . \$2,647,500.00

**A NOVEL PNEUMATIC HOIST.**

One of the newest applications of compressed air motors is shown in our engraving, which is made from a photograph of a 5,000-lbs. pneumatic hoist. It is claimed to have none of the objectionable features of the cylinder or electric motor hoists. Two reversing motors are attached to the side plates, with pinions on each end of the motor meshing in

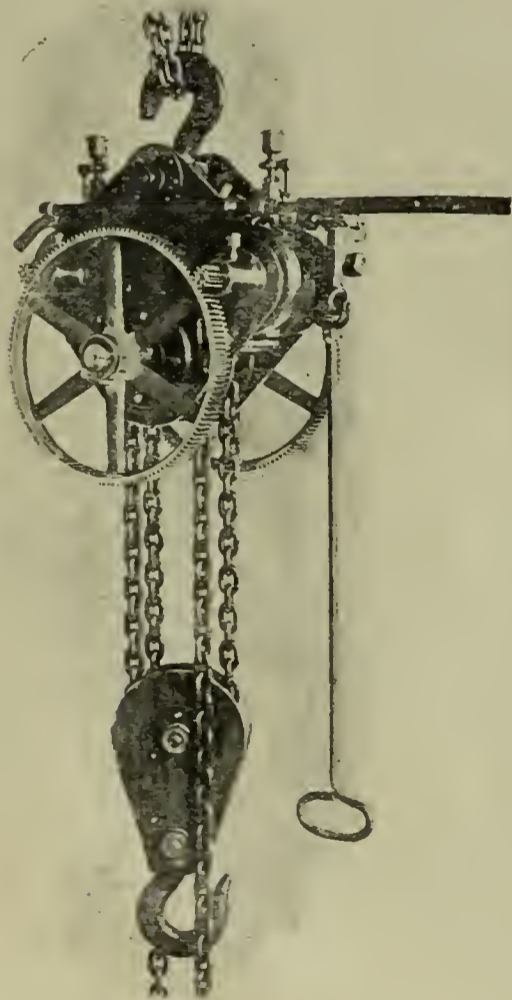

**A NOVEL PNEUMATIC HOIST.**

driving gear wheels which in turn operate the hoist mechanism. Two sprocket wheels run on the differential principle. The hoist is operated by an extension bar with a knuckle joint, as shown. It is easily managed, being under perfect control of the operator at any point of the hoist. There is no ten-

dency to jump or vibrate with a varying load. The operator can hoist or lower a load any number of feet with equal facility. Being a chain hoist, any length of hoist desired can be obtained, unless otherwise ordered. With each hoist is furnished twenty-five feet of chain which gives about a ten-foot lift.

The hoist will hold its load. This claim is made without qualification and is guaranteed. The reason is plain from the differential principles involved. The hoist does not depend on the air at all to sustain the load. In fact the motors may be detached while the load is suspended, without affecting it.

Where head room is an object this hoist has a field no other except a hand hoist can fill. It takes up no more room than a hand hoist and has none of its bad features. It is almost as independent as a hand hoist, as it can be hung up anywhere from an eye bolt, traveler, or end of a crane—any place where it can be reached with the air hose. This hoist is manufactured and sold by the Empire Engine and Motor Company, 1014 Havemeyer building, New York city.

**AIR BRAKE RECORDS.**

The Nashville, Chattanooga & St. Louis Railway is keeping a close record of air brake cars and of the condition of their brake equipment. Mr. J. W. Thomas, Jr., assistant general manager of this road, favors us with the following suggestive report of air brake cars forwarded over the Chattanooga division from Nashville during the month of January. The various brakes are designated by numbers for obvious reasons:

During the month of January, 1898, there were 399 freight trains out of Nashville yard.	
Average rating of freight trains . . . . .	19 cars
Total number of air brake cars forwarded on such trains . . . . .	1915
Air brake cars O. K. . . . .	1794
Air brake cars cut out . . . . .	121
Average serviceable air brake cars to train . . . . .	4.5
Of the 121 cars cut out there were of Air Brake Company No. 5:	
Triple valves out of order . . . . .	3
Triple valves gummed up . . . . .	8
Sand holes in triple valves . . . . .	1
Release valves leaking . . . . .	4
Broken cylinders . . . . .	2
Broken cylinder gaskets . . . . .	2
Broken auxiliary reservoirs . . . . .	1
Release springs broken . . . . .	2
Piston packing leather worn out . . . . .	1
Piston heads broken . . . . .	1
Brakes would not apply . . . . .	2
Leaking out of exhaust port or pressure retaining valve:	
Air Brake Company No. 5 . . . . .	23
Air Brake Company No. 1 . . . . .	6
Total . . . . .	29
Brakes leaked off:	
Air Brake Company No. 5 . . . . .	2
Air Brake Company No. 1 . . . . .	2
Total . . . . .	5
Brakes would not release:	
Air Brake Company No. 5 . . . . .	3
Air Brake Company No. 1 . . . . .	2
Total . . . . .	4
Air Brake Company No. 1; quick action in service application . . . . .	11
Air Brake Company No. 2; release too slow . . . . .	3
Air Brake Company No. 3; brakes unreliable . . . . .	17
Air Brake Company No. 4; brakes would not apply . . . . .	1
Broken main pipes . . . . .	1
Broken branch pipes . . . . .	7
Brake rigging out of order . . . . .	8
Defects not shown by report . . . . .	8
Total . . . . .	121

**NOTE.**

In some instances inspectors did not have the time to take triple valves down and inspect them, in order to see what was wrong.

Forty-seven of the 121 cars upon which the brakes were cut out were cars belonging to private car lines.

**IMPROVED METHODS OF KEEPING MILEAGE, OIL AND WASTE AND FUEL ACCOUNTS.**

The letter from which the following extracts were taken was not written for publication, but the matters spoken of are so important and the matters are of such general interest that we have yielded to the temptation of printing them. The writer is Mr. C. H. Lewis, chief clerk of the motive power department of the New York, New Haven & Hartford railroad system:

"The mileage book, the oil and waste book and the fuel book which I have gotten up save a great

deal of labor. For instance, the mileage for the two systems, the New York, New Haven & Hartford, and the Old Colony, is kept in my office here in New Haven. The report of mileage is generally completed and sent in to the comptroller the second or third day after the close of the month. The oil and waste and the fuel accounts are handled in a similar manner, though they cannot be gotten out so promptly as, of course, they must be made up from the mileage reports.

"When I came to the Consolidated railroad we had only 143 locomotives and two mileage clerks were employed to keep the mileage. The Old Colony system, at the time it was leased, had, if my memory serves me right, four mileage clerks. When I became chief clerk of the locomotive department of both systems I put my mileage book into service, with the result that the mileage work formerly done by six or eight clerks has ever since been done by one. (There are 711 locomotives on the two systems.—Ed. Ry. M. M.). This mileage book not only shows the total miles run per day by each engine, but also what division it runs over, so that at the end of the month when the book is footed up and the recapitulation columns filled in, you know at a glance just what the engines have been doing, the divisions which they have been running over, the kind of service and the amount of each kind.

"To give you an idea of the promptness with which we have our summary sheet out at the end of each month, I will say that our January, 1898, sheet went to the printer the morning of Feb. 11, and should be ready for distribution by the 14th or 15th.

"Our oil and waste and our fuel accounts are each handled by one man. We take charge of the fuel account after the coal is delivered at the docks. By the use of our systems of keeping mileage, oil and waste and fuel accounts we were able to dispense with the services of twenty-eight clerks in the car department alone, when the consolidation took place and the two departments were combined, and we are getting even better results than those obtained by the larger force.

"You are aware that a great many railroads have a great many different systems of accounts; in fact some of them have too many forms. The right kinds of forms pay for themselves in the end.

"It is a great advantage on a large railroad system to have as many accounts as possible kept in the general office. At our shops, of which we have a number of large ones, only the material and labor accounts are handled by the shop clerks; all other accounts are kept at the general office. This enables us to give information and answer questions promptly and saves a great deal of telegraphing and letter writing to the different shops."

**REVISION OF M. C. B. STANDARDS.**

The Master Car Builders' committee on supervision of standards and recommended practice of the association has issued a circular stating that it will be glad to receive suggestions in reference to any modifications of the established standards and recommended practices of the association as are justified by experience in their use. Such suggestions as have already come to the notice of the committee are given below, references being made to the Proceedings of 1897:

Journal box and details for journal, 3¾ by 7 inches; page 385, sheets 1, 2 and 3.—Suggested that a note be added on sheets 1 and 2 permitting the inner section of journal box to be either circular in form or square, provided all the other essential dimensions of the box are adhered to. Also suggested that dimensions showing radius of bore of journal bearing be changed from 1 29-32 to 1 15-16, making it correspond with the bearing and wedge ganges shown on sheet 3.

Journal box and details for journals, 4¼ by 8 inches; page 385, sheets 4, 5 and 6.—Suggested that a note be added on sheets 4 and 5, permitting the inner section of journal box to be either circular in form or square, provided all the other essential dimensions of the box are adhered to. Also recommended that the dimensions showing radius of bore of journal bearing be changed from 2 5-35 to 2 3-16, to correspond with similar dimension on journal bearing and wedge ganges, sheet C.

Brake head and shoe; page 386, sheets 8.—Suggested that in the design of brake shoe and head the clearance of ¼ inch at either side between the central lug of the brake shoe and the adjacent lugs of the brake

head, with similar clearances at either end of the brake shoe, should be reduced to 1-16 inch, thereby allowing less play back and forth between brake head and shoe as the direction of rotation of the wheels change.

Automatic coupler; page 388, sheet 11.—Suggested that standard dimensions should be added to sheet 11, defining length and spread of guard arm. If agreed to suggestion, please give recommendations as to these dimensions.

Screw threads, bolt heads and nuts; page 391.—Suggested that the report of the joint committee with the Master Mechanics' Association on square bolt heads and nuts may embody some suggestions affecting these standards

Air brake repair card.—Suggested, as a result of the discussion at the last convention, that the form of Defective Air Brake Card should be changed to conform in general with that shown on page 210 of the 1897 proceedings.

Buffer blocks with M. C. B. couplers: page 403, sheet B.—Suggested that the reference to M. C. B.

age of 53,112 miles. Fig. 2 shows wear on another baggage car in the same service, which made 72,605 miles. On this car one truck was fitted with the frictionless side bearing. The comparison between the work of the two trucks is impressive. It will be noted that the flange wear, especially of the truck having the frictionless bearing, is scarcely discernible.

PERSONAL.

C. S. Nason, formerly master mechanic of the Bangor & Aroostook, died at Bangor, Me., January 28.

Mr. John Carter, of Norwalk, O., traveling engineer of the Lake Shore railway, died suddenly February 14 of neuralgia of the heart.

Mr. James Hickey has been appointed master mechanic of the Gulf & Interstate railway, with headquarters at Beaumont, Tex.

Mr. J. A. Edwards, general foreman of the Rio Grande Southern shops at Ridgway, Colo., has been appointed master mechanic of that road.

Mr. A. D. Allibone has resigned as purchasing agent

John Mulligan, president of the Connecticut River railroad, died at his home in Springfield, Mass., February 21, at the age of 78 years. Mr. Mulligan was in early life a machinist and locomotive engineer, and was in 1852 appointed master mechanic of the Connecticut River road. He remained with that road until his death, serving as superintendent from August, 1868, to November 1, 1890, when he was chosen president.

Mr. A. W. Sumner, the purchasing agent of the Pennsylvania railroad, died suddenly of heart disease at his residence in Moorestown, N. J., January 29. Mr. Sumner was about 57 years old, and was born in New Jersey. At an early age he entered the employ of the Northern Central Railway Company, and ten years ago, when the purchasing department of that road was consolidated with the main road, he went to Philadelphia as the assistant of Enoch Lewis. About four years ago the latter retired and Mr. Sumner succeeded to the office.

Mr. P. N. Hyden has engaged with the car department of the Lake Shore & Michigan Southern railway at Cleveland, O. He will assist Master Car Builder Dow, and will be engaged largely in the work of inspection of new equipment. Mr. Hyden was with the Pullman Car Works for many years, during which

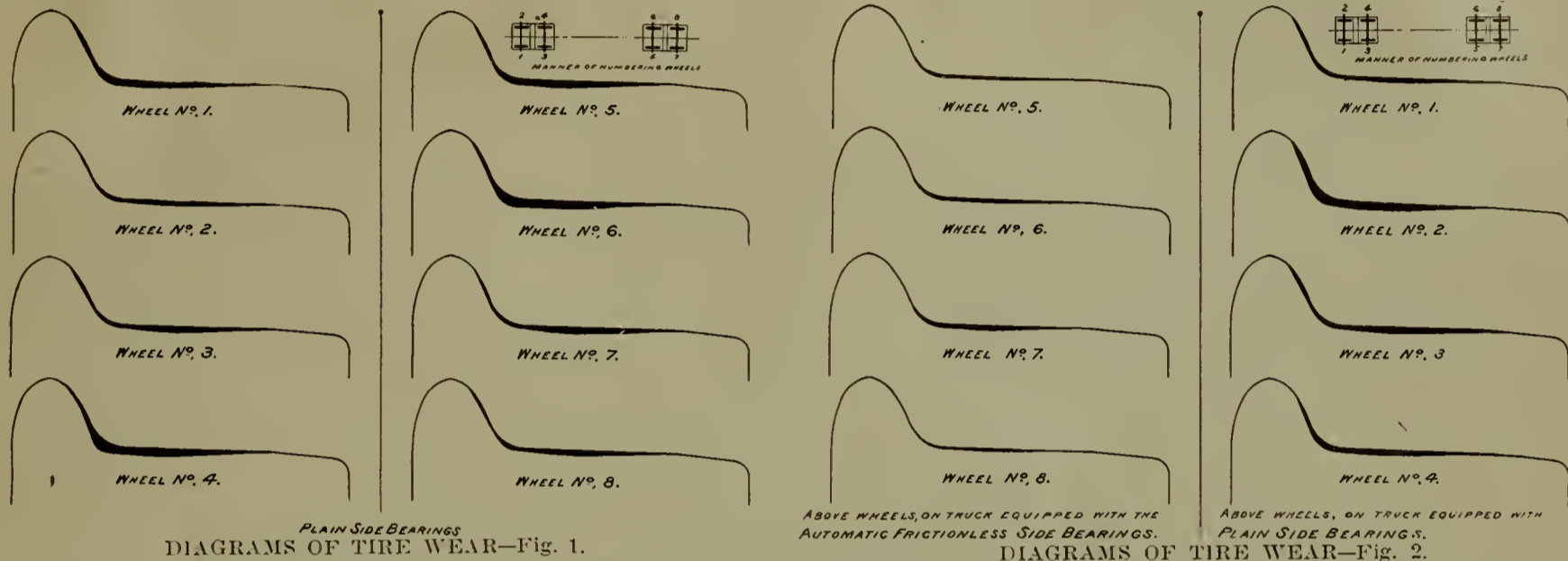

DIAGRAMS OF TIRE WEAR—Fig. 1.

DIAGRAMS OF TIRE WEAR—Fig. 2.

sheet B under the title of this recommended practice is unnecessary, as the buffer block to be used with M. C. B. couplers is a regular standard, shown on sheet 11.

Dummy coupling hook; page 405, sheet C.—Suggested that inasmuch as the use of dummy coupling hook is generally discontinued, that this recommended practice be dropped.

Loading poles, logs and bark on cars; page 411, sheet D.—Suggested that this recommended practice should be adopted as a regular standard of the association

Replies should be addressed to A. M. Waitt, General Master Car Builder, L. S. & M. S. Ry., Cleveland, Ohio, not later than March 15, 1898.

“DANGER IN ANNEALING”—A CORRECTION.

Mr. F. A. Pratt, president of the Pratt & Whitney Company, writes to us that an error occurred in his article on “Dangers in Annealing,” which appeared in Sparks from the Crescent Anvil, and which we copied in our last issue. We copied the error, in common with several other papers. His plan of annealing, he explains, involved the use of coal dust, and not saw dust, as it was printed.

FRICTIONLESS SIDE BEARINGS AS AFFECTING WHEEL WEAR.

Some practical tests of the automatic frictionless side bearing were made last year on the Lake Shore & Michigan Southern, and the results are now graphically shown by a series of diagrams prepared by the Chicago Railway Equipment Co., which handles the frictionless side bearing. We select two representative diagrams, to show the economy to be gained by the use of the bearing. The diagrams were made from plaster casts taken by A. M. Waitt, general master car builder of the Lake Shore road. They show how very much less the tires suffer when a frictionless side bearing is used. Fig. 1 shows the wear of tire on a baggage car running between Chicago and New York in fast passenger service, both trucks equipped with plain bearings, after a mile-

of the Wisconsin Central and has been succeeded by Mr. John A. Whaling, who formerly held the position.

Mr. Frank B. Henrietta, formerly general foreman of the C., C., C. & St. L. at Columbus, O., has been appointed road foreman of the Norfolk & Western, with headquarters at Roanoke, Va.

Mr. George B. McDill has resigned as chief clerk to President Burt of the Union Pacific, and will travel throughout the United States promoting the work of the railroad branches of the Y. M. C. A.

Edmund Taylor, at one time master mechanic of the Missouri Pacific, died at Raton, N. Mex., January 17, at the age of 80 years. He was formerly connected with Baltimore & Ohio for many years.

Mr. James M. Kirk, formerly with the Chicago, Rock Island & Pacific, has been appointed master mechanic of the Salt Lake & Ogden, with headquarters at Salt Lake City, Utah, to succeed Mr. W. T. Godfrey, resigned.

Mr. F. B. Smith, who has heretofore had the title of master mechanic of the New York, New Haven & Hartford railroad, has been given the title of general master mechanic. His headquarters are at New Haven, Conn.

Mr. William S. Worman has been appointed fire inspector of the Chicago & Northwestern, with headquarters at Chicago. It will be his duty to inspect all buildings and structures, with special reference to risk and danger from fire.

Mr. James M. Percy, formerly master mechanic of the Cincinnati, Hamilton & Dayton at Cincinnati, has been appointed master mechanic of the St. Louis division of the Baltimore & Ohio Southwestern, with headquarters at East St. Louis—a position that has just been created.

Mr. H. H. Vaughan, long well-known as the mechanical engineer of the Great Northern railway lines, has been appointed mechanical engineer of the locomotive department of the Reading railway machine shops in Reading, vice Edward L. Moser, resigned to accept a position in the drafting department of the Baldwin Locomotive Works in Philadelphia.

Mr. H. E. Walker has been appointed locomotive superintendent of the Interoceanic railway of Mexico, succeeding Mr. E. B. Sedgwick, resigned to engage in other business. Mr. Walker has been superintendent of machinery of the Mexican Southern railway for nearly seven years, coming from London when the road was commenced. His place will for the present be filled by master mechanic W. I. McCammon.

period, on several occasions, he superintended the construction of Pullman cars in England and in Australia. Later he was with the McConway & Torley Company, and more recently with the Pullman Company again, leaving the latter concern to go to the Lake Shore.—Railway Review.

Mr. Henry W. Johns, widely known as president of the H. W. Johns Manufacturing Company, died February 8, at his home in Yonkers, N. Y., after a prolonged illness. He was born in West Stockbridge, Mass., in 1837, and at an early age, says the Iron Age, came to New York City, engaging in various lines of business before entering on the asbestos industry, with which his name is more especially connected. In 1858, while experimenting with the view to perfecting a fire proofing compound, the indestructible character of asbestos impressed itself upon him and he devoted his entire attention to its development for commercial uses, building up a business of great magnitude.

SUPPLY TRADE NOTES.

—Mr. J. W. Duntley, president of the Chicago Pneumatic Tool Company, has again gone to Europe on a business trip.

—The Q & C Company has purchased the Stanwood metal car step and will hereafter manufacture it, and sell it, as the Q & C-Stanwood metal car step.

—Mr. W. H. Hooper has been appointed general agent of the Safety Car Heating and Lighting Company in Chicago, Ill., vice Mr. Geo. N. Terry, resigned.

—The Q & C Company is so pressed to meet orders that it proposes to build additions to its shops, and has already had plans prepared for the needed additions.

—The American Steel Casting Company, Sharon, Pa., is said to have orders for castings of 150 locomotives. An addition is to be built to this plant, 200x200 feet.

—The Boston Woven Hose & Rubber Company have moved their general offices and warerooms to the new building at 540 Atlantic avenue, corner of Congress street, Boston, Mass.

—A steady increase of business marks the popularity of the Moran Flexible Steam Joint Company's output. They are compelled to run their plant night and day to fill orders promptly.

—The Buckeye Malleable Iron & Coupler Company, of Columbus, O., through their Chicago agents, Julian

Yale & Co., have recently sold the Illinois Central railroad couplers for 10,000 cars.

—Mr. F. A. Johann, general sales agent of the Schickel, Harrison & Howard Iron Company, has resigned. We understand that Mr. Johann expects to continue in the railway supply business.

—Mr. E. L. Essley succeeds Mr. J. W. Gardner, resigned, in the Chicago office of Manning, Maxwell & Moore. Mr. Essley has been with the company at Chicago ever since the branch house was started.

—The Egan Company, of Cincinnati, Ohio, have just made a shipment of 12 carloads of wood working machinery to the Russian government, St. Petersburg. This is the largest export shipment of such machinery ever made.

—Messrs. Williams, White & Co., of Moline, Ill., received last month an order for the shipment of a carload of their bulldozers for export. They report domestic business as good and note a steady increase in railroad orders.

—The Rand Drill Company have recently furnished to the Valley Junction shops of the Rock Island road one straight line steam-driven air compressor with steam and air cylinders 12 inches in diameter by 16 inches stroke.

—Mr. Wilson W. Butler, manager of the Chicago office of the Sterlingworth Railway Supply Co., reports that the Sterlingworth rolled steel brake beam is going on 1,200 cars of the Armour car lines—making an order of 4,800 beams.

—Mr. C. A. Bennett, formerly with the Revere Rubber Co. at Minneapolis, has opened up an office and distributing store at 212 Nicollet avenue, Minneapolis, for the Jewell Belting Co. and the New Jersey Car Spring & Rubber Co.

—The Brady Metal Company, 100 Broadway, New York city, manufacturers of Magnis metal, have recently favored their friends with a handsome leather pass book on which the name of the recipient is stamped in gold letters.

—On account of largely increased business the Buckeye Malleable Iron & Coupler Company are building an addition to their plant 50x300 feet. This firm is now employing more men than at any time in their history in order to fill orders for couplers.

—At the annual meeting of the stockholders of the Niles Tool Works Company, of Hamilton, O., the following officers were elected: President, Alexander Gordon; general manager, R. C. McKinney; secretary, James K. Cullen, and superintendent, George T. Reiss.

—The Niles Tool Works recently shipped to the Texas & Pacific a double-head wheel lathe for the shops at Big Springs, Tex. A wheel lathe will also be put in at the Fort Worth shops, and the Toyah and El Paso shops will each be supplied with a turret head bolt-cutter, drill press, planer and lathe.

—The Clement Pneumatic Tool Company, of Philadelphia, has received among recent orders one from the Baldwin Locomotive Works for an equipment of caulking and chipping tools, and another from the United States Metallic Packing Company, Bradford, England, for a number of large riveting tools.

—The works of the Long & Alstatter Company, of Hamilton, O., are running full, with a large number of orders ahead. The company is just furnishing for the Johnson Company, of Lorain, O., a heavy steam-driven billet shear, which is the third machine of that type furnished to the same company. A number of special machines are also in course of construction.

—The Magnolia Metal Co., during the last three or four months, has received through the mails 2,827 distinct testimonials from every part of the United States and Canada, sent in by railway companies, steamship companies, rolling mills, iron and steel manufacturers of every kind and description, machinists, paper mills, cotton mills, woolen mills and wood working establishments of all kinds.

—J. A. Fay & Co. have received orders for 26 machines for the new car shops of the John Stephenson Co., at Elizabeth, N. J. At the awarding of the contracts for the wood working machinery for the Lima shops of the Cincinnati, Hamilton & Dayton Railroad they were given the entire order. This firm also recently equipped car shops in Siberia and in Russia, with their machinery.

—The Barney & Smith Car Company has been making some improvements in the machinery and equipment of its works. An electric dynamo and an air compressor have recently been installed and one of the transfer tables has been equipped with electricity. The operation of this table has been so satisfactory that the same equipment will be supplied to all the various transfer tables about the works of the company.

—The Long Island Railroad Co. has awarded to the Standard Railroad Signal Co., of Arlington, N. J., a 12-months' contract for furnishing all signal material that may be required during the period covered by contract. This signal company has also been awarded two plants at Belle Plaine, Iowa, on the Chicago & Northwestern Railway, consisting of 15 working levers and five spare spaces and 12 working levers and four spare spaces.

—The Chicago Pneumatic Tool Company has recently shipped 21 tools to the Sorombo Locomotive Works, Russia, and during the month of January received an aggregate of orders for 107 tools by cable from Europe. A small number of pneumatic hammers have been in use in the Russian locomotive works for some months past and the additional order referred to is of considerable importance in showing that the pneumatic tool is able to compete with low-priced labor.

—The Pond Machine Tool Company, of Plainfield, N. J., of which Manning, Maxwell & Moore are the representatives, were, says the Iron Age, successful in bidding for the equipment of machine tools for a new gun plant to be built in this country. All the large lathes, boring and turning mills, etc., are being supplied by this concern. Gould & Eberhardt, of Newark, N. J., were also successful in placing a large 30 inch stroke shaper. This is one of the largest shaping machines ever built.

—The Sessions Foundry Company of Bristol, Connecticut, announces that it has made arrangements with the Composite Brake Shoe Company of Boston to manufacture and sell their well-known Compo Patent Brake Shoe. Recent tests have shown that cork for inserts is more effective than wood for both street and steam railroads, and although more expensive than wood, cork has been adopted for all shoes, without additional cost to the consumer. The Sessions Foundry Company has first-class facilities for producing shoes and other castings in large quantities, of a superior quality of metal.

—The Sargent Co. of Chicago reports a very large business in railway supplies of late, and informs us that orders for the new Diamond "S" Shoe are coming in rapidly. This shoe, it will be remembered, was fully described in our columns in our issue of October, 1897. It is manufactured of cast iron with an insert of expanded steel, giving great friction and long life to the shoe, without injury to the tire. The company has made tests on a large number of railroads with uniform satisfaction, the result of which is shown by the large number of orders on their books. Mr. W. D. Sargent, the Vice-President and General Manager of The Sargent Co., has just returned from England and the Continent, where he has been engaged in introducing the Diamond "S" Brake Shoe. Notwithstanding the proverbial conservatism of foreign railway managers for American inventions, the merits of the shoe are so clear, that several of the railroads in England are already using them, and the prospect for a large extension of this business, is most flattering. The Sargent Co. has recently published the second volume in its series on the Diamond "S" Brake Shoe, giving the results of the remarkable tests of this shoe, which were conducted on the Brake Shoe Testing Machine at the shops of the Westinghouse Air Brake Co. at Wilmerding, Pa. The company will furnish copies of these pamphlets together with results of service tests to all railroad men, upon request.

—There has been considerable criticism in various newspapers of the project of the Snow & Ice Transportation Co., to run their locomotives over the snow and ice fields to the Klondike, notwithstanding the fact that some of the locomotives have been in successful operation in lumber camps before this time. In an interview in the Daily Morning Tribune of Portland, Ore., Mr. Rosenfeld, the manager of that company, says: "I don't care what some man from the backwoods of Alaska or from any other part of the world thinks about the idea of ice trains. I suppose no amount of argument could convince a man who has never seen one of these machines, that it will work. I don't care about the private opinion of people, and I don't care how heartily they laugh at the idea of the scheme, but I do object when a man who knows absolutely nothing about the venture, pretends to say positively, that the idea is not feasible. How does he know? Why should his opinion carry more weight than mine, when I have investigated this thing and found enough in it to induce me to invest money in it? All I want is fair play." It will probably be of interest to our readers in this connection to know that The Sargent Co. of Chicago, furnished the steel castings and gears for this machinery, which amounted to something over a carload, and secured this order by their ability to make prompt delivery, the time being a week less than that of any other competitors.

—The equipment of the South Side Elevated Railroad of Chicago with electric power is rapidly nearing completion. The Sprague Electric Company's system of propulsion of cars and trains on this road has already proven its merit and given general satisfaction. During the past winter the railroad officials sought to determine the advisability of equipping their cars with electric heaters, and in order to satisfy themselves that the adoption of electric heaters would be to their advantage and at the same time find out which heater of the many offered was the most suitable for the purpose, they had some very careful and extensive tests made of the heaters of five of the most prominent electric heating companies in this country. Each of these companies was given the privilege of equipping a car and the five cars thus equipped were run during the past winter. The result was that the contract was awarded to the Gold Car Heating Company of New

York and Chicago. The car which the Gold Company equipped was supplied with twenty-four of the improved "Gold Standard" Electric heaters. The heaters were wired to permit of six graduations of temperature, which was controlled with a regulating switch. The car was comfortably heated in the coldest weather and the regulation of the temperature to suit the outside conditions was entirely satisfactory. With the "Gold Standard" Electric Heaters a perfect uniformity of the temperature was maintained at all times in all parts of the car. This contract covers the entire equipment of the South Side Elevated Railroad and calls for about three thousand electric heaters. This is one of the largest orders ever placed for electric heaters.

#### Arrangements for the June Convention.

The Standing Committee of Railway Supply Men for the Master Car Builders' and Master Mechanics' conventions of 1898 issues the following circular, which gives valuable information for intending exhibitors:

"The next annual conventions of Master Car Builders' and the American Railway Master Mechanics' Associations will be held at Saratoga Springs, N. Y., beginning on Wednesday, June 15th. The Master Car Builders will convene on that date and will hold their sessions for either three or four days, and the Master Mechanics will begin on the following Monday, June 20th, and conclude their sessions on Wednesday, June 22d. By this arrangement the two conventions will be embraced within the period of eight days.

"The joint committee of the associations has selected Congress Hall as the headquarters, and the hotel rates agreed upon are as follows: Single room, one person, without bath, per day, \$3.00; double room, one person, without bath, per day, \$4.00; double room, one person, with bath, per day, \$5.00; double room, two persons, without bath, each person, per day, \$3.00; double room, two persons, with bath, each person, per day, \$4.00.

"Applications for rooms should be addressed to Col. H. S. Clement, Saratoga Springs, N. Y.

"It is the desire of the officers of both the Master Car Builders' and the Master Mechanics' Associations that the exhibits of supply houses should be as complete and instructive as possible, and to that end the standing committee is making every endeavor to arrange for satisfactory exhibits. The rear verandas and the court at Congress Hall have been placed at the disposal of the committee to be allotted to exhibitors without charge.

"The committee has arranged with the management of Congress Hall to furnish steam from a 65 horse power boiler, a part of the plant of the hotel. A main pipe will be run overhead through the middle of the court and connections may be made by exhibitors at convenient locations. Exhibitors desiring power will have to furnish the necessary connections from the main steam pipe and also such engines or motors as may be required.

"The heavy exhibits will be located on the lower veranda (ground floor) and in the open court. In making application for space, exhibitors will confer a favor by stating the nature of their exhibits and whether they desire space under cover or in the open court.

"The committee has received a proposition from Carpenter & Taylor, of Saratoga Springs, for cartage to and from the exhibit grounds at the following rates: Single boxes weighing up to 1,000 pounds, 25 cents each way; three to five boxes, not exceeding 2,000 pounds, 50 cents each way; for heavy machinery, the cost of cartage may be arranged for by special contract.

"In shipping exhibits, it will be best for the exhibitor to consign the same to himself, care of Congress Hall, Saratoga Springs, N. Y., and if the exhibitor finds it impossible to be on the ground to arrange personally for the transfer from the railway station to the exhibit grounds, a letter of instruction to the secretary of the standing committee, care of Congress Hall, Saratoga Springs, N. Y., will serve to have the necessary cartage done, but, of course, no unpacking or installation of exhibits will be undertaken by the committee or any of its representatives.

"It is the hope of the committee that the installation of all exhibits will be completed by the evening of Tuesday, June 14th, so that the exhibitors may have the benefit of the full period of the conventions, and that there may be as little noise and confusion as possible on the first day of the Master Car Builders' meeting.

"Applications for space and other information should be addressed to Hugh M. Wilson, Secretary, 1660 Monadnock Block, Chicago."

The standing committee for the year is as follows: A. J. Schevers (chairman), Great Northern Building, Chicago; D. W. Clark, Pittsburg; F. E. Barnard, 11 Oliver street, Boston; Clarence H. Howard, Union Trust Building, St. Louis; Hugh M. Wilson (secretary), 1660 Monadnock Block, Chicago.

#### WANTED.

A married man with experience in various railroad departments, and also as salesman of railroad supplies (especially car couplers and journal bearings), desires a position of trust with some railroad company or as agent for some responsible supply house. References first-class. Address W, The Railway Master Mechanic.



# RAILWAY MASTER MECHANIC

WALTER D. CROSMAN, Editor.

EDWIN N. LEWIS, Manager.

PUBLISHED MONTHLY BY

THE RAILWAY LIST COMPANY.

Devoted to the interests of railway motive power, car equipment, shops, machinery and supplies. Communications on any topics suitable to these columns are solicited.

Subscription price, \$1.00 a year, to foreign countries \$1.50 free of postage. Advertising rates given on application to the office, by mail or in person. Address

THE RAILWAY LIST COMPANY,

The Rookery, Chicago, Ill.

The Official Railway List is published by this company.

VOL. XXI. CHICAGO, APRIL, 1898. No. 4.

ALL of our readers who enjoy sport with gun or rod will be interested in the article on page 46 entitled "Railway Mechanical Engineering and Camping out, Hunting and Fishing."

SUPERINTENDENTS of motive power of the larger roads who are in charge of the car department should encourage their chief clerks to attend the Master Car Builders' June convention. The chief clerk often has a more intimate knowledge of the rules than his superior and soon discovers, in the course of his daily duties, the flaws and uncertainties in those rules.

AT THIS time, when railroads are applying so many M. C. B. couplers and such a large percentage of the active cars are equipped with them, it is quite surprising to know that during the last year one of the largest western roads purchased as many links and pins as it averaged yearly for the preceding four or five years. In view of the fact that, until recently, the amount of traffic has been quite stationary for two or three years, the question arises whether links and pins, like the M. C. B. coupler, have been increased in size and quality of material in proportion to the increase in severity of service. If they have not, does an increase in the number of breakages account for the continued large use of the link and pin?

THERE are just an even one hundred different automatic couplers that are given in the latest government statistics as being applied to the car equipment of the United States. This is the number for the year ending June 30, 1896. There are twenty-seven others which appear in records of previous years, but which are not set down as in use in the year named—evidently dropped out, at least for the time being. There are also records of 181 cars, having automatic couplers "unclassified." Of the 100 definitely specified, 42 are on more than 100 cars each; 23 are on more than 1,000 cars each; 16 are on more than 5,000 cars each, and 9 are on more than 10,000 cars each. There are a few that go to higher figures—to the twenty and thirty thousand point—and two that go far beyond the one hundred thousand point. When one stops to think of what these facts mean to the men in charge of cars, who are expected to keep the cars going at a minimum of cost and of trouble, it is not surprising that there exists a strong feeling in favor of reducing the number of couplers to be accepted in interchange.

CHIEF ARTHUR of the Brotherhood of Locomotive Engineers, has long been noted for his conservatism and for the forceful style of his public utterances. He recently said some good things concerning labor organizations and capital before a meeting of railway employes, expressing himself in one portion of his address as follows:

I differ with many labor leaders as to methods to be pursued in bringing about the best results. I say that organized labor is the hope and salvation of the workingman. The great stumbling block that has injured us in many ways is the so-called labor organization which attempts to dictate. It cannot see two sides of any question. We should give and take. The interests of capital and labor, I say, are identical, and the only way these matters can be settled is by a fair, honest method—Christianity, I might say. We must do unto others as we would have them do unto us. We must recognize the fact that we are all entitled to certain

considerations. What is capital? You work, accumulate money, and get into business. Must you be condemned for that? I say no. That is capital. It is only when it becomes tyrannical that we resist it.

It is the practice of the principles of Christianity which is needed in contests between labor and capital, as Mr. Arthur says, and we may add that it is often needed on both sides.

## HIGH GRADE STEEL

It is perhaps unfortunate that the author of a railway club paper does not introduce the subject at the meetings by giving a brief synopsis of what it contains and by pointing out the features which can be profitably discussed. The most valuable parts of the paper might then reach many who do not read them. It is for this reason that we believe that many of our readers have not realized just what it is that makes nickel steel or Coffin steel so superior to ordinary open-hearth steel, though it was explained in both of the papers read and discussed at the February meeting of the Western Railway Club.

With high pressure steam, and large cylinders, and high speed, the stresses in locomotive machinery are so great that iron is no longer adequate for the requirements, and steel, as made and forged in the ordinary way, has often proved unsatisfactory. The idea that steel should be soft, ductile and of low strength, like good iron, in order that it will not crack, has, without doubt, been the cause of more failures, and has retarded progress in the substitution of steel for iron more, than any other one thing connected with this revolution. It prevails today to a large extent in the views of many master mechanics as to the proper strength of fire-box and boiler steel. The specification calling for 60,000 pounds tensile strength, with limits 55,000 pounds and 65,000 pounds, was adopted by the Master Mechanics' Association in June, 1894, but only about one-half of those connected with the larger roads have adopted these limits, the others preferring to use steel having a strength as low as 50,000 pounds.

Tests made at Homestead and at South Chicago show that the elastic limit of fire-box steel is 50 to 60 per cent of the ultimate strength, and therefore for low strength steel only 25,000 to 30,000 pounds. This is the factor which must be taken in designing boilers, and considering the stresses which are caused by expansion and contraction, as well as by direct steam pressure, and it is not surprising that they sometimes exceed the elastic limit of the sheets and produce rupture.

The most desirable physical quality steel can possess is high elastic limit, combined with high elongation, and when this can be obtained in boiler steel we believe in using even higher limits than the master mechanics' specification names. If an elastic limit of 35,000 to 40,000 pounds and elongation of 22 per cent are obtained in a steel having 70,000 to 75,000 pounds ultimate strength, it would probably be a more desirable material for locomotive boilers, than that now in common use. It may not be generally known that a Krupp steel fire-box, having a strength of 75,000 pounds, has been in successful service in this country for a number of years. With the improvements which have recently been made in the metallurgy of steel, the more intelligent builders may in time increase the maximum limit of boiler steel to 75,000 pounds. We have said all this to illustrate the value of high elastic limit and good elongation for steel wherever stresses are high.

In nickel steel the elastic limit is over 60 per cent of the ultimate strength and for locomotive machinery forgings it is as high as 50,000 to 60,000 pounds, coupled with 22 to 25 per cent elongation in eight inches. This high strength and high elastic limit are due to the alloy of about three per cent nickel. But an ordinary forging of this material would not resist severe shocks or repeated bending any better than one made of good carbon steel.

In order to obtain the highest resistance a steel forging must be heated up in the process of manufacture to a temperature between 1,200° and 1,300° Fahrenheit, and then suddenly cooled and annealed. It is this process which gives the metal ductility, high elongation, or, as more commonly expressed, toughness. Again, annealing lowers the ultimate strength and elastic limit, and while we have gained one good quality we have lost others. It is necessary, therefore, in the final heat treatment of nickel steel to oil temper, and this not only restores the ultimate strength and elastic limit, but increases the elongation, and we thus finally obtain the desirable

combination already mentioned, of high elastic limit and high elongation.

By changing the per cent of carbon, any strength, from 50,000 pounds to 100,000 pounds, can be obtained in carbon steel, but only by the use of nickel can so high an elastic limit as 60,000 pounds and good elongation be obtained. Nickel steel is therefore specially adapted to such purposes as driving axles, crank pins, and piston rods. The failure of these parts, in the past, when made of steel, has been largely due, first to the use of low strength steel (about 60,000 pounds ultimate strength), and second, to the fact that the forging strains and coarse crystallization due to gradual cooling were allowed to remain. The grade of steel best suited to such details is that having an ultimate strength near 80,000 pounds, and elastic limit of 50,000 pounds, with good elongation.

The Coffin process aims to improve the quality of ordinary steel forgings, by quenching in water at the recalcrescent point—1,200° to 1,300° Fahrenheit—and cooling rapidly to a dull red color in the dark, and then allowing them to cool gradually in the air. The forging is thus relieved of internal strains, and the structure of the steel changed from a coarse crystallization to an amorphous state. The elastic limit is raised nearly 50 per cent, and the elongation is not reduced. This is another method of obtaining the desirable qualities of strength and toughness, and is well adapted to the improvement in the quality of car axles. It is much cheaper than oil tempering, and where ordinary strength is required should be preferred to the common method of forging and annealing steel as practiced in the railroad smith shops. Both the processes described arrive at the same result, but the Coffin process has its limitations far below that which nickel steel can show.

Our final word is that specifications for steel for locomotives, whether in the boiler or forgings, should require higher strength than that which has been ordinarily used heretofore. The prominent feature of a steel specification should be high elastic limit and high elongation. When elastic limit is thus made more prominent, the method of determining it should be defined. The method of testing will thus be developed, and a simple method of measuring elastic limit will be found, and one which the railroad testing department and steel manufacturers can agree upon.

## COMPOUND AND SIMPLE LOCOMOTIVES.

There will be found elsewhere in this issue a paper that was read by Prof. R. A. Smart before the St. Louis Railway club on the subject of the "performance of a four-cylinder compound locomotive." Prof. Smart makes a comparison between the performance of the four-cylinder compound and a simple locomotive and arrives at conclusions some of which will be surprising to many and which would seem to demand a more complete explanation of the tests and some information concerning the simple engine with which the comparisons are made. It would be, probably, not unreasonable to expect that when such important conclusions are drawn and one source of information is described so completely that the description of the other should be just as complete so that others might judge of the fairness of the comparison. There is not the slightest reason, however, to expect that an unfair comparison has been made, and we would direct attention to the conclusions drawn and suggest that they are worthy of much consideration.

The truth of the third conclusion is questionable, and Prof. Smart casts suspicion on it himself by explaining it in a foot note and offering a suggestion for the disagreement of the conclusion and the data. The simple engine was tested at 6-inches and 8-inches cutoff, and the compound at 10-inches and 11-inches cut off, and it is explained that the former cutoff is common to passenger service and the latter to freight service; from this it is reasoned that if the simple engine were operating at a longer cutoff, the steam consumption for it would have been greater, and that if the compound were working at a shorter cutoff, the steam consumption for it would have been less. It would be interesting if Prof. Smart would explain his reasons for such conclusions. Many tests have shown that the most economical cutoff for simple engines, whether in passenger or freight service, is at from 1-4 to 1-3 the stroke, whereas on the other hand those who are most interested in having the compound locomotives

make the best possible showing insist that the cut-off for compound locomotives shall not occur earlier than  $\frac{1}{2}$  the stroke, and the reverse lever quadrants are not graduated between a point near the  $\frac{1}{2}$  cut-off notch and the middle position. It would be presumed, therefore, that so far as the relative points of cutoffs are concerned, the two locomotives were operated on quite similar conditions.

Prof. Smart says that the general opinion is that the compound is better adapted to the slower freight service and that it cannot be used to advantage in passenger service; undoubtedly this was the opinion that was formed after some very extensive road tests were made three or four years ago, but it is probably not the general opinion now. Those who are in a position to get their information from experience with both classes of locomotives in service, say that whenever a simple engine is averaging more than about 1-3 cutoff there are two courses to be pursued to produce a saving in steam consumption: either to put on compound cylinders or to put on simple cylinders so much larger that the cutoff may be reduced to the economical point—between  $\frac{1}{4}$  and  $\frac{1}{3}$  the stroke. Sometimes it is not possible to apply larger simple cylinders; then if the compound cylinders can be applied, a saving in steam consumption will result. This means that in either freight or passenger service, the compound may show economy over the simple engine if the latter is working at a disadvantage.

#### THE M. C. B. COUPLER.

It has been said that of the many devices in use by the railroads of this country no one of them has been the cause of so much expense and trouble, either to apply or to maintain, as the vertical plate automatic coupler, commonly known as the M. C. B. coupler; and there are those, men who are in the best position to know by experience, who say that the declaration is only too true. It was thought that by the adoption and general use of the M. C. B. coupler many sources of worry would disappear and that it would prove a "joy forever;" but those who were most instrumental in having the design adopted are first to recognize its weakness both as regards its outline and its proportion. It is not intended to convey the impression that the M. C. B. coupler is likely to be discarded immediately, nor, indeed, is it possible to foresee that such a step is likely to be taken for years to come, if ever, but were a car coupler being designed with the information at hand to-day and without regard to the couplers now in use, the new coupler would, we feel quite sure, not resemble, closely, the present M. C. B. form.

Considering, first, the outline and general form of the coupler; about the only attractive feature of it is that it will, sometimes, couple automatically with another coupler of the same kind. On this account the device should be credited with a saving of many arms to trainmen and of many dollars (which otherwise would have been paid for personal injuries) to railroad companies. The word "sometimes" in the preceding sentence will be more strongly emphasized by many who will recall aggravating delays at points where it is necessary to couple together cars on curves, in hauling up off the curve to make the coupling and then backing down again. At how many stations in the country is it possible on every one of the station tracks to easily couple up the longest trains handled by the roads using such station? This brings out one of the pronounced objections to the M. C. B. coupler; its outline and principle of operating is such that it must be held almost rigidly, from horizontal and from vertical motion with reference to the car. This rigidity is objectionable not only because it, in combination with the outlines of the coupler, prevents coupling on curves over which cars and locomotives are operated every day but because, also, this lack of side motion has been the cause of wrecks on equipment which has been coupled on tangent track or on track with a radius sufficiently great to allow the couplers to engage, and then run over curves on which the couplers would not engage. The declaration may seem startling, but it is very true, that to the rigid attachment of the M. C. B. coupler which is necessary for the coupler to fulfill its functions properly, is to be charged the derailment of tenders and of cars with short overhang, when these are coupled to cars with a long overhang. Experiments have been made and reported in our columns [See Railway Master Mechanic for January, 1897, p. 11], which show that the pressure between the coupler

bar and that part of the draft rigging which secures it from side motion, is as great as 57,000 pounds in the case of an express car with long overhang when coupled to a locomotive tender and when passing over curves which are quite common in railroad yards, though which probably seldom are found on main lines. This is a condition of which railroad men cannot feel proud.

Secondly, the lines of the M. C. B. coupler and the proportions of the parts were approved at a time when railroad equipment was much lighter than at present, and when the tonnage per train was much less than at present; perhaps the coupler was designed sufficiently strong for the condition prevailing at the time, but a grave error was made in not providing means for increasing its proportions to correspond with the increased severity of service demand. The only means left open for increasing the strength of the coupler was one over which the designers had no control—the improvement in the quality of the material of which the coupler is made. Such method of improvement may prove to be sufficient, but it may prove costly. Had there been left a way to increase the size of parts as the service required increased in severity a cheaper material might be used in the coupler.

The foregoing will emphasize the necessity of carefully drawn specifications for couplers and for careful inspection to insure that such specifications are rigidly enforced. There is some discussion now in regard to the possibility of increasing, gradually, the proportions of the M. C. B. coupler, the idea being to increase the present dimensions slightly but not so much that the present coupler would not operate satisfactorily with the coupler as strengthened, and to stop at once the production of couplers having the present standard proportions; in the course of a few years there would not be left many couplers of the present proportions and at that time another step in the direction of increasing the proportions might be taken. It would be only a question of time then when the coupler would be sufficiently strong to meet all requirements. If such a step is considered necessary the earlier it is taken the earlier will the results be enjoyed. Depending entirely upon the use of better material in the couplers for protection against the certain increase in the severity of the service demanded seems to be extremely shortsighted, because such dependence will urge the railroads to the use of material of gradually improving quality and, presumably, gradually increasing cost. The preceding statement may seem erroneous in view of the gradual decrease in price of couplers to the present time, but with more carefully drawn specifications and more rigid inspection of the couplers must come, if not an increase in cost of material, then certainly a slower decrease in the same cost, the result, in either case, being unfavorable to the railroads.

It has not been the intention to decry in the foregoing the use of the M. C. B. coupler—that would be madness—but to urge the speedy consideration and, if possible, settlement of the question of increasing its present proportions.

The Chicago and Northwestern railway has recently provided new equipment for its two night trains between Chicago and St. Paul and Minneapolis. The equipment is provided with all the latest features of strictly first-class trains, including electric lights. The current for the lights and, in summer, for the fans is generated in the baggage car, the Westinghouse engine employed receiving steam from the locomotive boiler. An especial feature of the train is the use of electric lamps on the outside of the broad vestibule end posts. Shields are provided above the lamps and their location is such that when the lamps are aglow the station platforms are nicely lighted directly where light is most needed—at the car step. It is the intention, eventually, to light these lamps only at stations, but at present they are used all the time the current is on and the effect, to one viewing the passing train from a little distance, is quite pleasing.

The large Mastodons locomotive built last year by the Brooks Locomotive Works, for the Mexican Central Railway, from designs prepared by Superintendent of Motive Power Johnstone of that road, is reported to be doing most excellent work. It is said that it is hauling about double the load of the double enders previously designed by Mr. Johnstone, and at

the same time effecting a saving of 55 per cent in fuel, 50 per cent in engine crew wages, 75 per cent in repairs, and from 40 to 50 in oil, etc. This Mastodon was illustrated in our issue of November, 1897.

#### NOTES OF THE MONTH.

As bearing upon the difficulty of obtaining a technical education in car building, Mr. A. M. Waitt, general master car builder of the Lake Shore & Michigan Southern Railway, made some suggestive remarks in the course of a lecture which he recently delivered at Purdue University. Mr. Waitt said that there "are few of us who have had the good fortune to have the benefit of a mechanical training in a technical school but have sought to obtain as thorough a knowledge as possible of the fundamental features of locomotive design and operation; but until coming in actual contact with the railway service we have been in complete ignorance of the vast extent of the problems of car design, construction, maintenance and interchange. It is to be hoped that the graduates in mechanical engineering in future years, who may choose railroading for their career, may be more fully equipped for handling the perplexing problems which confront the mechanical superintendent in the car department work, as well as the locomotive department." Continuing, he said: "When the statistics found in the 1897 issue of Poor's Manual show that in 1896 there were on American railroads 36,080 locomotives, 32,627 passenger equipment cars, and 1,189,927 freight equipment cars, and when it is considered that the locomotives, as a rule, are continually running on the home road, while the vast number of cars are largely moving on foreign roads, oftentimes never being in the shops of the home road for months and sometimes years at a time, it will be seen that the problems which confront the mechanical superintendent, in connection with the maintenance of his migratory car equipment, are likely to be much more complicated and arduous than the maintenance of the smaller number of locomotives which are constantly under the watchful care of the road most interested in them."

\* \* \* \* \*

In the same lecture Mr. Waitt spoke as follows, in a general way, of car designing:

In designing railway cars, the mechanical engineer is met with a series of problems far different from those found in the design of any stationary structure. With stationary structures, like buildings and bridges, there are well-known formulæ on which to base calculations as to the proper size of materials to be used, but in the case of a car moving in a rapid train, and sometimes over rough tracks and around curves and over frogs and switches, and subject to the severe shocks and jars incident to railway service, there are no rules or formulæ which can be used in designing the work. Experience, observation, the experience of others, and good judgment, are the principal factors which it is necessary to rely upon in car design. To one in practical railway service, the frequent inspection of the scrap pile will give valuable data to assist in eliminating from a car weak features in its construction. Cars being structures subject to such unusually severe usage, necessarily require frequent repairs and renewal of parts; hence in designing great consideration must be given to so construct as to provide for ease in maintenance and repairs, as well as strength and symmetry in the first construction. As cars do not remain always on the home road, but are dispatched to all parts of the country, and require repairs in shops many miles from the home road, it is desirable, as far as possible, to have uniformity in dimensions and shapes, so that no unnecessary expense or delays in getting material may occur when a car has to be repaired away from home; hence the use of the so-called Master Car Builders' standards, as far as possible, should be a fundamental rule in the car builders' mind. With cars of the present day there seems to be no limit to the variety of sizes and capacities. In passenger service the sleeping cars have now reached a length of 80 feet over all, and between 10 and 11 feet wide, while passenger coaches and baggage and mail cars range from 40 to 60 feet over all according to the necessities of the roads. In freight equipment the cars vary from 28 up to 50, and in a few cases, even 60, feet in length, according to the possibilities of gaining extra tonnage by the increase in dimensions of cars a few inches in length, width or height, above that of a competitor. Many efforts have been made to obtain uniformity in the general dimensions of freight equipment, but little has thus far been accomplished. It has been agreed by the American Railway Association that, for general traffic, box cars should be limited in size to 37 feet in length, 9 feet 1 inch in width over sheathing, 9 feet in height from bottom of sheathing to top of eaves, and should have a maximum capacity of 60,000 pounds.

For special lines of traffic these limits are often exceeded.

\* \* \* \* \*

The railway is a new thing in Corea and is treated as a novelty after a truly novel manner by the government authorities of that country. Mr. H. Collbran, who is at the head of the Seoul-Chemulpo railway now building, (the Brooks locomotives for which we illustrated in our last issue) sends to the Railway Age a copy of the first official order concerning the road. The order, termed a dispatch it will be noted, is as follows:

Dispatch No. 1.

To His Excellency, Honorable Sye Saug Kyo, the Kamni of Chemulpo:

The communication of the member of the American Seoul-Chemulpo Railroad Company is that they are going to lay the iron line [rail] to let the firewheel car [train] run and rebuilding the road.

We regret extremely to hear that the travelers, bulls and ponies passed the road and damages were done.

The basis of the railroad is:

The force of the firewheel [engine] is very rapid and if anything touches it, there is no time to escape and the death will happen within minute of breath.

The passing of tourists, bulls and ponies must be strictly forbidden, specially referring to sanitary purpose.

As we communicate to you, your respectful Kamni must put up a signboard along the road, valleys and villages notifying the reason we communicate.

If anyone disobeys the order and damages the road, they must rebuild them and the expenses of repairing must be paid by the villagers of the village or town.

Hoping you will let people understand well, so that they do not disobey this order. Yi Chai Yune.

Commissioner of Seoul-Chemulpo Railroad. 7th day of the 2d moon of the 2d year of Kwang-Moo.

\* \* \* \* \*

Employees on the Pennsylvania Railroad have reason to feel gratified over the condition of their relief fund and savings fund. The membership of the employees' relief fund of the lives east of Pittsburg and Erie at the close of the past year was 43,675, the largest since its establishment. During the year the members contributed \$739,052.21, while the company and its affiliated lines contributed \$109,619.89 for operating expenses and \$45,939.90 for extra benefits to members whose disability had continued for over fifty-two weeks and who were therefore no longer entitled to regular benefits from the fund. The total receipts were \$914,789.12, and the balance on hand at the beginning of the year \$436,968.09. After distributing \$308,284.31 in death benefits and \$326,933.96 in cases of disability arising from sickness and accident, and meeting all its obligations and providing for unadjusted death claims, a balance of \$508,736.95 remained to the credit of the fund as the result of its operations for the last three years, out of which must be paid unadjusted claims for benefits growing out of sickness or accident occurring during that period. There will probably be a surplus of \$246,937.50 after providing for such liabilities, making its aggregate surplus for the entire period of the fund \$616,523.18. The number of depositors in the employees' saving fund at the end of the year was 5,267, an increase of 323. The amount received during the year from depositors was \$479,424, and the balance in the fund at the close of the year was \$1,953,114.72, of which \$1,800,000 is invested in securities bearing interest at the average rate of four per cent.

\* \* \* \* \*

The Richmond Locomotive Works have recently presented to Purdue University a full-sized model of the front end of one of their two-cylinder compound locomotives, the intercepting value of which is sectioned so that its operation may be seen. The cylinders are 20 and 30 inches in diameter, respectively, and the saddle is surmounted by a full-sized smokebox and stack. The whole makes a very complete and impressive exhibit. Master mechanics who were at Old Point Comfort last June will recall seeing this exhibit, and will remember the interest that its presence aroused.

\* \* \* \* \*

A fair idea of the extent to which the electric transmission of power has been developed may be gained, says Wm. Baxter in the Popular Science Monthly, from a consideration of the fact that one manufacturing concern alone has sold over two hundred thousand horse power of machinery for this purpose within the last four or five years, their sales for 1896 being over seventy-five thousand horse power. The great increase in the business during the past year, in the face of a general stagnation in

all other lines of industry, is a very clear indication that what has been done in the past has been entirely successful—so much so as to inspire an amount of confidence sufficient to overcome the apathy or unwillingness to embark in new undertakings so manifest in all other lines of business. The total number of water-power transmission plants in successful operation in the United States in addition to the Niagara installation is, says Mr. Baxter, over two hundred. The amount of power transmitted ranges from less than one hundred horse power up to twelve thousand, and the distance of transmission from a mile or so up to thirty-five miles.

\* \* \* \* \*

The Northern Pacific is having success with a number of small cooling stations which it last year established along its line. These stations have two 35-ton cone pockets served by a link belt conveyor, operated either by a gasoline engine or an electric motor. An ingeniously arranged dynamometer upon which the pocket rests, operates a dial indicator, giving a quick and accurate reading of weight of cone in the pocket, thus facilitating easy ticketing of coal drawn to the engineer.

\* \* \* \* \*

In a review of the recent engineers' strike in England Mr. S. N. D. North says, in the Popular Science Monthly for April: "In a word, the purpose of the manufacturers has been to so change the basis of their industry that they can increase production by reducing costs, not through reduced wages, but through the more complete utilization of modern mechanical inventions. They have insisted that the individual workman would, in consequence, earn much higher wages. The movement on the part of their employes was one to limit production by the shorter working day and by the increased cost of increased overtime work at overtime wages. The ends aimed at were diametrically opposite, and the intensity and the prolongation of the struggle are thus explained. It was an issue which admitted of no compromise. A truce might, indeed, have been patched up, and the battle declared a draw; but any conclusion short of the complete surrender of one side or the other would have left the vital issue as unsettled as at the start. As that issue has been stated, the impartial student finds it difficult to understand why it should exist at all. If the iron masters are right in their contention that reduced costs of production, through greater machinery efficiency, are necessary for the preservation of English manufacturing against foreign encroachment, the welfare of their workmen is as vitally involved as their own. This is only another way of stating a time-worn truism that the interests of capital and labor are identical, in any true analysis of their relationship."

\* \* \* \* \*

The Western Railway Club will hold its next regular meeting at Purdue University, Lafayette, Ind., on Tuesday, April 19th. The club will leave over the Monon on a special, ahead of the regular morning train out of Chicago, and will give the afternoon to an inspection of the laboratories of Purdue and the shops of the Monon railway which are at Lafayette. The university authorities have agreed to make special arrangements by which the scope and character of the engineering work may be seen to best advantage. The trip to and from Lafayette will afford excellent opportunity for social intercourse which in itself may be counted as one of the privileges of the occasion. An official statement of the program for the day will soon be issued to members of the club.

\* \* \* \* \*

The mantle for Welsbach lights was discovered accidentally it is said. In a recent lecture on incandescent gas lighting, delivered at the London Institution recently, Professor Vivian B. Lewes stated it was the accidental boiling over of a solution of lanthanum which led Dr. Welsbach to the discovery of the power of the rare earths to emit light. He was struck with the bright light emitted by a piece of asbestos over which the solution had spread itself.

\* \* \* \* \*

A good thing for refrigerator car trucks, if not too expensive, would seem to be a new rust preventer that is said to have been adopted by the German army and by a large number of European manufacturers. It is described as being composed of greases and volatile oils, which evaporate on exposure to the air, leaving an air tight film or skin adhering tightly to the metal, and absolutely and

permanently preventing the corrosive action of salt air, salt water, rain, snow, dampness, steam, gases, and fumes of acid or ammonia. It is neutral, contains no acid, and leaves neither spots nor marks when removed. The coating is transparent, and as it does not dull the appearance of bright metal surfaces, it is of special service to machinery builders.

\* \* \* \* \*

Mr. Frederick A. Delano, superintendent of the Chicago terminals of the Chicago, Burlington & Quincy Railway Company, gave a lecture in the series of addresses on railway subjects before the engineering students of Purdue University on March 9. His subject was "Railway Signalling." After carefully classifying such signals according to their form and the purpose for which they are employed, Mr. Delano confined his attention to a discussion of the fundamental principles affecting the operation and interpretation of fixed signals. He traced the historical development of the signal idea, discussed the larger and more general questions involved, and disclosed the tendencies of present practice. The lecture was illustrated by means of models and diagrams, which will be given in connection with the text as finally published by the university.

\* \* \* \* \*

Later in the month Mr. Arthur M. Waitt, general master car builder of the Lake Shore & Michigan Southern Railway, delivered the eleventh lecture in the same course at Purdue. Mr. Waitt, representing the car department, called attention to the fact that more than a million cars enter into the equipment of American railways. He described the many different purposes which they are designed to serve and called attention to the difficulties to be met in maintaining them in good order. The important problems to be met in car design were discussed in connection with a description of the construction of a typical box car. It is safe to say that the students to whom he spoke had never before imagined the variety and number of conditions to be met in the construction of what to many, may seem a rather simple structure. The address was illustrated by means of colored charts which served well to demonstrate the principal points developed. Some brief extracts from his lecture are given elsewhere in these columns. The next and last lecture of the course will be given by Dr. Charles B. Dudley, chemist of the Pennsylvania Railroad, who will represent the chemical department of railways.

This course of lectures was arranged with a view of presenting to the advanced students of Purdue, the significance of the important problems making up the organization of a railway company. The general plan is to continue from year to year, the expectation being that departments having no representative in any given year will be given a place in the work of the succeeding years.

\* \* \* \* \*

A party of French engineers, headed by M. Victor Sabouret, principal engineer of bridges and roads of the Orleans Railway, and M. Solacroup, principal assistant engineer of the rolling stock and locomotive department of the same road, have been visiting leading cities of the United States during the past month. They are investigating our leading railroad systems and examining particularly into all electric traction plants en route. They gave a close inspection to the electrical plant of the Baltimore & Ohio railroad in the tunnel at Baltimore, and are understood to contemplate a similar installation for a proposed underground line to run from the center of Paris to one of its suburbs.

\* \* \* \* \*

The Railway Y. M. C. A. is doing a noble work, as every one is getting to know. But the statistical facts concerning this work are not so familiar. One of the many journals published under the auspices of the association—the Headlight, of Detroit—gives the following facts: There are 130 railway associations and departments, employing 145 secretaries and assistants, and having over 31,000 paying members during the year, and a much larger number resorting to the rooms. These rooms are always open to the employes of railway, palace car, express and telegraph companies, and men in the railway postal service. There are 3,792 members serving on committees. Forty-nine associations occupy buildings owned by them, or placed at their service by the railway management. There is a total average daily attendance at rooms in 100 associations of 12,164. A total of \$259,998 was paid out last year for current expenses in 106 associations. Of this

amount, about 25 per cent was contributed by the employes and the balance by the railway companies. There are 89 libraries, containing 63,365 volumes. There were last year 322,024 baths taken in 90 of the associations, and 18,185 visits to sick and injured men were made by the secretaries and committees in 85 associations.

\* \* \* \* \*

The Royal Administration of the Swedish State Railways invites civil engineers or other interested parties to a competition of designs for the arrangement of new railroad stations, junctions, etc., etc., for the city of Stockholm. The first prize is to be 12,000 Swedish crowns (about \$3,230), the second 8,000 Swedish crowns (about \$2,150) and the third, 4,000 Swedish crowns (about \$1,075.) The time for competition will expire at noon on the 31st of August, 1898. Particulars concerning the nature of the work will be furnished by the Swedish-Norwegian Legation, 2011 Q street, Washington, D. C., or by the vice consul of Sweden and Norway, Mr. August Peterson, LeDroit building, cor. F and Eighth streets, Washington, D. C. Security to the amount of \$13.50 for the use of the drawings in this competition is required, but this will be refunded when the drawings are returned. Vice Consul Peterson expresses the hope that some of our American engineers will carry off some, if not all, of the above generous prizes.

\* \* \* \* \*

Dry rot is much feared and a cheap, convenient and effective preventive would be welcomed. A German publication says that antinonnin is successfully used for the disinfection of wood. The chemical is odorless, easily soluble in water, very penetrating, and a powerful disinfectant even in very dilute solutions. The application is easy; it will kill the dry rot, and when used on sound wood acts as a protection to it.

\* \* \* \* \*

The Master Car Builders' Committee on Care of Journal Boxes—Best Method of Packing—asks for prompt replies to the following questions, to enable them to make up a report to present at the convention to be held at Saratoga next June. The committee is: J. T. Chamberlain, J. J. Hennessey and R. H. Johnson.

- 1st. Would you recommend a high or low grade oil?
- 2d. What does it cost you per 1,000 miles for car lubrication?
- 3d. Do you use any special cooling compound to prevent or cool hot boxes? If so, please state what it is and what your experience has been with same.
- 4th. How much oil do you use per car, per 1,000 miles?
- 5th. What is average number of hot boxes per 1,000 miles?
- 6th. Do you prefer cotton or woolen waste, and why?
- 7th. Is there any other material, whether patented or not, that you would recommend instead of waste for packing, and why?
- 8th. How long do you consider it necessary to soak waste before using, and at what temperature?
- 9th. What device, whether patented or not, do you recommend to prevent dust from entering rear of journal box?
- 10th. What journal-box lid, whether patented or not, do you prefer, that would prevent leakage of oil and at the same time be dustproof?
- 11th. What particular method, if any, have you in arranging the packing in the journal boxes?
- 12th. Do you consider it good practice to remove the old packing, mix the best of it with new, thoroughly saturated waste for repacking? If so, how often should this be done?

\* \* \* \* \*

Railway employes were warmly defended, recently, in Congress by W. B. Shattuc of Ohio. Mr. Fox of Mississippi had asserted that railway managers "voted them" (the employes) after the manner that the southern cotton planters controlled the votes of their laborers. He had further asserted that the great body of the voters among railway employes had no comprehension of party principles. Mr. Shattuc resented all this in the following ringing words which will meet with approval not only in the north but, we believe, also in the south:

There is not a railway manager in this country who does not know the charge to be without any foundation at all, and I make the statement that no manager could retain his position on any railway in this country for thirty days should he undertake any such policy. There is not in this country to-day a more independent, manly, courageous, and generous class of people than those in the railway service. It would not be safe for anyone to undertake to control the suffrage of these people. These railway employes are, as a rule, well educated, self-relying, self-respecting, quick

to resent any move that appears to be an infringement of their personal rights, and I am glad to say from personal knowledge that they resented very emphatically similar slanders in 1896. \* \* \* I am safe in saying that there are 400,000 railway employes in this country who can secure teachers' certificates in Alabama or in Mississippi. I am prepared to say that there are 225,000 trackmen in the United States to-day, working for the railroad companies, who would on an educational test rate higher than would the white population of Mississippi and Alabama combined, excepting Tupelo. I pretend to say, Mr. Chairman, that you can take a sufficient number of employes from the railways of the United States and fill every office in the government, from the highest to the lowest, elective and appointive, and that, too, without seriously impairing the service of the railroads.

#### RAILWAY MECHANICAL ENGINEERING AND CAMPING OUT, FISHING AND HUNTING.

Of all the railroad men who take or ought to take the RAILWAY MASTER MECHANIC, there are very few who do not enjoy a spell of camping out and hunting or fishing. Hundreds who will read this are planning to go to the woods, the prairies or the lakes late in the season and hundreds more (alas, it is thousands) are longing to do so and cursing the hard fate which makes it impossible.

The next best thing to an outing with gun or rod is to read the real and true experiences of those who have been able to get away from work for awhile and indulge in this glorious play. In descriptions of genuine experiences one can follow the trail, stalk the elk or deer, climb to the haunts of the mountain goat, flush the sudden covey or play and bring to the gaff the trout or bass or muscallonge.

We propose to give to all who wish to, the chance to mix these enjoyments of the fields and woods and waters with the hard, prosaic facts of railroad-ing. We have arranged with the publisher of *Recreation* to furnish that publication and the RAILWAY MASTER MECHANIC at club rates. It is a great opportunity for all who are interested in nature and the wild creatures which hide in her wildernesses and waters.

*Recreation* is a monthly magazine devoted to hunting, fishing, canoeing, marksmanship and, to some extent, to bicycling. At the head of that magazine is a man who has hunted and fished in nearly every district of the United States and Canada. Its contributors are not the "literary fellows" who imagine adventures at so much a column, but practical hunters and fishermen who write simply and graphically about what they have themselves experienced. Those who read it will know where to spend to the best advantage the precious two or three weeks of the annual vacation in the east, west, north or south, and what gun and ammunition to take, and what rods and lures. It is the most readable magazine of its kind.

The RAILWAY MASTER MECHANIC has been speaking for itself for these many years. Those who begin taking it continue to take it as long as they are interested in railway mechanical engineering.

We will furnish both these publications (the price of each of which is \$1 a year) to any address for \$1.50. Sample copies will be sent on application. Address the Railway List Company, The Rookery, Chicago, Ill.

#### COMMUNICATIONS.

##### Locomotive Steam Gages—A Rejoinder.

Cleveland, O., March 26, 1898.

To the Editor of the Railway Master Mechanic:

An article appears in the March issue of your paper relating to Locomotive Steam Gages, the author begging for space to state a few exceptions to an article on "Some Notes on Locomotive Steam Gages," which appeared in the February issue of your paper. In these exceptions the author points to misuse of mechanical terms and to glaring contradictions.

He says that the "Notes" would lead off with the idea that steam gages on locomotives are invariably to be found on the boiler-head, whereas but a small percentage are so found. Mr. Monaghan has put a very narrow construction on the term boiler head. He would limit the term boiler head to the back head of the boiler, while the term boiler head includes all of that part of the locomotive boiler to which the steam fittings are applied. This may include some of the back head or back sheet or it may not include any of it. It will be due to the construction of the locomotive as to what part of the boiler constitutes the boiler head.

When the ordinary steam gage is so situated that it becomes heated to a temperature such that the bare hand cannot be placed on it with reasonable comfort it should be moved to a cooler place, regardless of how

it became so heated, or of its fastenings, whether they are attached to the back head or boiler head.

In writing the article I used such terms as are familiar to the enginemen using steam gages on locomotives. By the use of these familiar terms it was hoped to place before this class of men an article that would be easily understood.

The table of results of a test determining the effect of heat on an ordinary steam gage, given by Mr. Monaghan, shows how easily a gage is affected by a little rise in temperature, especially when the temperature is of moderate high degree. The rise of—

65 degrees Fahr. produced error of . . . . . 4½ pounds.  
71 degrees Fahr. produced error of . . . . . 5½ pounds.  
90 degrees Fahr. produced error of . . . . . 6½ pounds.  
143 degrees Fahr. produced error of . . . . . 7½ pounds.

This error of 7½ pounds in the gage indication, due to its being heated 143 degrees, from 80 to 223, is no trifle to be overlooked by any engineman or fireman.

There is reason for believing that Mr. Monaghan could have secured a gage for test that would not have shown such an error due to the heat as the ordinary gage which he used, and furthermore, there is reason for believing that there are many gages now in use that would show a much greater error or variation if subjected to a similar test.

It was stated that a steam gage, owing to its location, may show more than twenty pounds error in its indication, and Mr. Monaghan asks "Why what curiosity and not gratify it?" To any man it should be gratification enough to know that in hot steam gages there is great liability of error and that by moving the gage to a cooler place the error due to over-heating can be avoided.

Mr. Monaghan is afraid that there was an excessive indulgence in that dexterous manipulation known as hair splitting, by testing a gage at 60 degrees temperature and then locating it where it will be heated to 100 degrees and thus deceive the fireman. The article reads—100 degrees or more. The words "or more" ought to dispel any thought or idea of hair splitting. As Mr. Monaghan has shown by test that a rise of only 143 degrees produces an error of 7½ pounds in the gage indication, I think it a fair and logical conclusion that, when a hair grows as large as seven and one-half pounds in 143 degrees rise in temperature, it is justifiable to resort to dexterous manipulations to split it.

Mr. Monaghan writes of the evil of long water columns, citing in his experience a case where a boiler was located in the second story above the steam gage. The order of the present day is to build large locomotives and should any be so large as to have the boiler in the second story above the steam gage we may profit by his citation.

Mr. Monaghan (in next to the last paragraph in third column of his communication) calls the author's (Mr. Curtis') attention to an astonishing statement and an undeniable contradiction in the very next and final sentence. There is no contradiction in the last paragraph of the article, anything to the contrary by Mr. Monaghan notwithstanding. It was stated that the steam gage pipe (the gage steam connection) should always be connected direct to the boiler. The rest of the paragraph deals with the steam gage connection, connected to the fountain. Note that this was said: "If it (the steam and connection) be connected to the boiler head-fountain, the steam turret, or any device that has a number of boiler head fittings attached, it will be governed by the pressure in the fountain." As to the correctness of this statement there is no doubt. Then it was stated, that "when both injectors are working, they taking steam from the fountain, there will be several pounds pressure less in the fountain than in the boiler." It is a fact that steam will not flow from the boiler to the fountain unless there is less pressure in the fountain than in the boiler. The number of pounds less in the fountain depends on the supply passage from the boiler to the fountain, and the amount of steam passing from the fountain. Be the variation of pressure in the fountain much or little, when it is caused by the use of the injectors, a simple way to detect it was given, thus: "This may be detected by noting the boiler pressure" (that is the gage indication) "when both injectors are working, and then shutting off both injectors at once and noting the instantaneous rise of pressure by the gage indication." There is nothing said about the instantaneous rise of the boiler pressure, but note the words "gage indication." This second reading of the gage indication should indicate the correct pressure in the boiler, providing that the gage be of proper temperature.

Some men if they see the gage instantaneously indicate a rise of pressure due to shutting off the injectors, actually believe that the whole pressure in the boiler was instantaneously that much greater. They do not stop to reason, as other men do, that some circumstance may exist that causes a variation of pressure between the boiler and the fountain. To men that have made the above error the closing sentence of the first article will be of benefit.

Mr. Monaghan states that the evil effect of 220 to 225 degrees Fahr. on a steam gage is very marked, and then he says, "but surely no Master Mechanic would allow a locomotive steam gage to be so situated as to be heated to 225 degrees." I feel safe in saying that there are conscientious and practical men in charge of

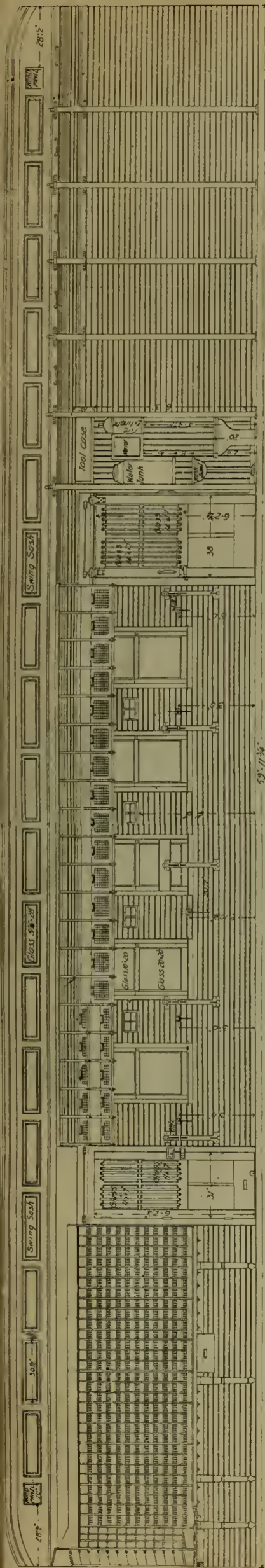

INSIDE ELEVATION.

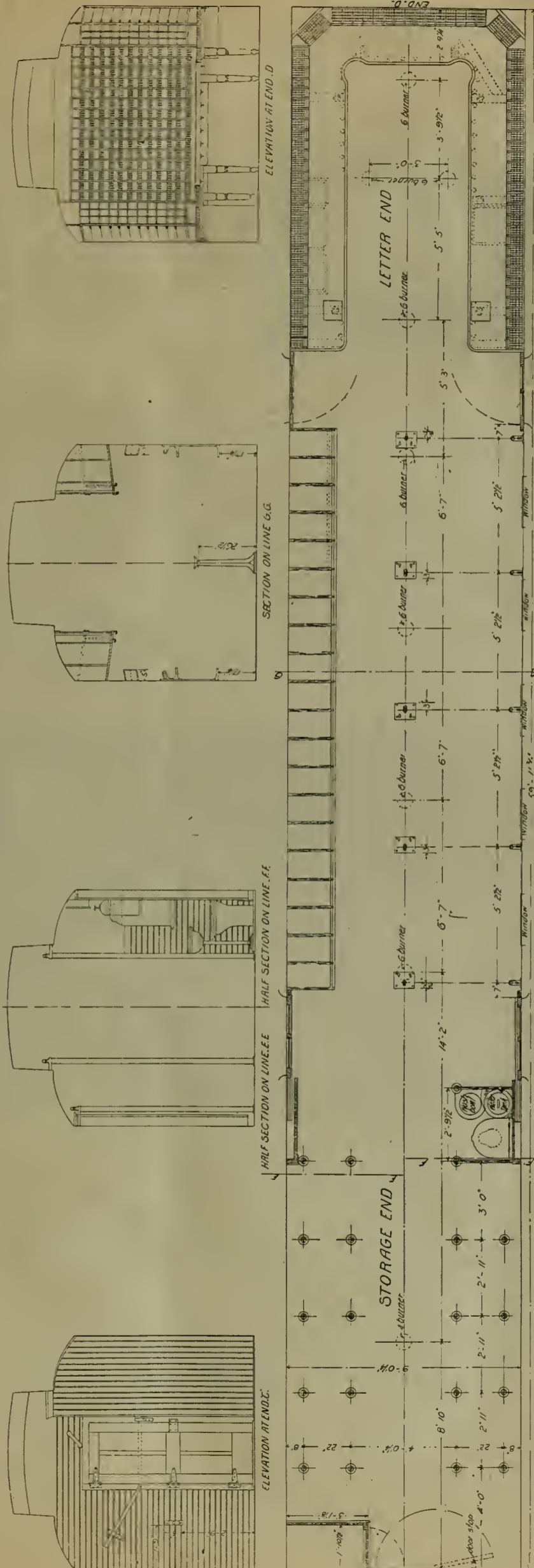

FLOOR PLAN AND CROSS SECTIONS.

NEW MAIL CAR—LAKE SHORE & MICHIGAN SOUTHERN RAILWAY.

steam boilers that do not know that excessive heating of the ordinary steam gage will cause the gage to indicate a pressure that is not the actual pressure in the boiler.

Thos. H. Curris, Mechanical Engineer.

MAIL CAR—L. S. & M. S. RAILWAY.

The Lake Shore & Michigan Southern Railway has recently built at its Cleveland shops two combination mail cars adapted to the distribution of both letters and papers. Through the courtesy of Mr. A. M. Waitt, general master car builder of the Lake Shore, we are enabled to present the accompanying illustrations of these very complete and up-to-date cars.

The inside perspectives given in half tone, and the cross sections, inside elevation and floor plan given in line detail, quite clearly reveal the careful attention to the planning of a perfect car that is only suggested by the clean cut exterior view that

is also presented. (The apparent blemishes on the letter board are simply iceles.) Indeed the illustrations are so complete that but little in the way of descriptive notes is called for.

These cars are 60 feet long, inside. They provide space for letter distribution, paper distribution, and for storage. The cars have no end door in the letter end. The letter cases are of the usual form, except that the bottoms of the boxes are made of brass wire instead of solid, thereby preventing the collection of dust. The labels are placed on small four sided revolving pieces at the front end of each compartment, thus permitting the use of four different labels for each box. Convenient drawers and lockers are provided under the letter tables. The paper compartment is fitted with standard Harrison racks. Above these racks on one side of the car are located additional distributing space in the shape of boxes having sliding fronts. The stor-

age space is conveniently divided by stationary round stanchions. In one corner is located a convenient clothes closet and locker; in the other, near the door, is located the wash stand and hopper. The storage end of the car has an end door.

The lighting of the car is amply provided for. It is equipped with Pintsch gas, and the gas lamps are so distributed that there are four 6-burner lamps in the letter end, four 6-burner lamps in the paper compartment and one 4-burner lamp in the storage end. The car is also equipped with Adams & Westlake No. 11 slide lamps for use in emergency cases if the gas should give out, these lamps being stored in a locker provided for that purpose, and suitable brackets being provided for holding the lamps when it is necessary to use them.

The car is equipped with steam heat applied in accordance with Lake Shore standards, using that company's special graduating steam admission

valves, and the Gold vertical traps controlling the drips.

As to details of car framing and general design we may say that the car is built without platforms but has a heavy outer end sill. It is equipped with the Gould latest style passenger couplers and the Gould continuous buffer. The end of the car is so constructed that the Gould rubber diaphragm and face plate for vestibule can be applied in front without changing the end. The car is equipped with Lake Shore standard six-wheel trucks, having brakes on all wheels. The truck has 36-inch Paige wheels, and National Hollow brake beams with self-adjusting heads. The car weighs ready for service about 87,000 pounds. It is painted pure white, and lettered in accordance with the standard style adopted on the fast mail lines running between Chicago and New York via the Lake Shore and New York Central.

**INSTRUCTIONS TO ENGINEMEN.**

Mr. Geo. M. Burns, fuel agent of the Wabash Railroad Company, has issued the following notice to enginemen:

Beginning March 1, 1898, an individual account will be opened with each engineer, to which all coal used by him will be charged. At the same time the car mileage made by such engineer will be computed, and at the

as light a fire as possible to avoid waste of steam at the safety valve.

In addition to seeing that firemen carry out the above instructions, engineers should use good judgment in the use of the injector, as economical firing cannot be done unless water is supplied to the boiler regularly.

Attention is also called to the importance of using the feed water heater, as by that means warm water is supplied to the boiler, thus saving considerable of your

duces a deficient and wasteful distribution of steam at high speeds of rotation.

This feature of compound locomotive performance has, so far as the writer is aware, not heretofore been investigated by comparative tests.

It was the purpose of the tests of which this paper is the record to investigate the cylinder performance of the compound locomotive at high speeds, to determine in particular the change of power and steam consumption with increase of speed. The tests were made upon the engines of a Vaclain compound locomotive, which are mounted in the engineering laboratory at Purdue University. Since only the effects of speed on the action of the steam in the cylinders was in question, no record of boiler performance was needed. In Appendix 1 is given in detail a description of the plant, together with a statement of the methods employed in making the tests.

Two series of tests were made, one with the reverse lever in the first notch off center, giving an approximate cut-off in the high-pressure cylinder of 10 inches, and a total number of expansions of 4.8; the second with the reverse lever in the second notch, giving an approximate cut-off of 11 inches, and a total number of expansions of 4.2. Each series consisted of a number of tests at speeds ranging from 100 to 270 revolutions per minute.

The steam pressure under the throttle for the first series average about 140 pounds; that for the second series, about 130 pounds. This, it will be seen, is somewhat below that used in the best practice, and while not materially affecting the comparative results, would have a tendency to make the engine less efficient. In Appendix 2 is given a summary of the observed and calculated data.

The variation of mean effective pressure and horse power with increased speed and cut-off is shown in the following table:

TABLE 1.

R. P. M.	Miles per hr.	M. E. P.				Total H. P.	
		10-in. Cut-off	11-in. Cut-off	10-in. Cut-off	11-in. Cut-off		
100	300	18.7	59	36	68	33	164
170	510	30.2	48	25	59	25	230
230	690	43.1	45	17	56	21	288
270	810	50.6	43	16	55	20	324

For ease of comparison the results for the two series



NEW MAIL CAR—L. S. & M. S. RY.

end of the month a statement issued showing the performance of each engineer based upon the number of pounds of coal consumed per car mile by each, those having the best record in their respective classes being at the top. This is intended to place each engineer strictly upon his individual record, with a view to determining who are the most economical in point of fuel consumption, and the showing of each in this regard will be considered in connection with promotion and preferment in the service.

The new form of coal ticket is intended for use by road engines only. Each engineer will be furnished a book of tickets, which he will retain until the end of the month, regardless of the engine upon which he is engaged. An engine going out on a run is delivered to the engineer with a tank full of coal, or its equivalent in tickets, and the engineer is required to give tickets not only for the coal taken on the trip, but also (in case of changing engineers) for a sufficient amount to put

heat energy. Water in tenders should be heated to from 70 to 90 degrees before leaving terminals. The injector heaters should be used to prevent popping off and at the same time to assist in heating water in the tender.

Enginemen should apply the smoke suppressors before shutting off, especially on passenger trains, thus avoiding a very serious nuisance and preventing waste of fuel as well.

**WORK OF A FOUR CYLINDER COMPOUND AT PURDUE.**

Elaborate tests of a four cylinder compound engine of the Vaclain type were some months ago made at Purdue University by Messrs. Meriam and Cooper, students, under the supervision of Prof. R.



LETTER END—MAIL CAR—LAKE SHORE & MICHIGAN SOUTHERN RAILWAY—STORAGE END.

the engine into the house at the end of the run with a full tank of coal, the same as he received it. In case of engineers changing at terminals where no coal is issued, the engineer giving up the engine must give to the hostler tickets to an amount equal to the number of tons that would be required to fill the tender. These tickets must be delivered by the hostler to the engineer taking the engine out, and he can use them at the next coaling station to replenish his supply.

No capable man will want to see his name at the bottom of the list, and in order to avoid this, intelligent methods must be employed in the firing and handling of engines to secure the most economical results.

In the first place, it should be explained that the large percentage of gas contained in bituminous coal is nearly all driven off by the heat in a few seconds after the coal enters the fire-box. If fresh air is mixed with this gas, it will burn and generate heat. If not, it will pass out unconsumed in the form of smoke, causing a waste and creating a nuisance. The formation of smoke can be largely prevented by careful and intelligent firing. If but one or two shovels of coal are put in at a time and the door is left a little way open for a few seconds, air will mix with and burn the gas generated from the same. Firemen are cautioned to discontinue the practice of charging three or more shovels full of coal without intermission, and to work with

A. Smart, M. E., assistant professor of experimental engineering—a second series of tests being conducted entirely by Prof. Smart. The results of the tests, and deductions therefrom, together with a description of the apparatus used and of the method of conducting the test, are given in a paper presented by Prof. Smart at the February meeting of the St. Louis Railway Club. We append the substance of this paper, as follows:

The compound locomotive has made its way into favor in the United States but slowly, considering the progress which it has made on continental railways and the well-substantiated claims of economical performance in certain grades of service in this country. These claims are based upon the results of numerous road tests and show economies in coal and water ranging from 10 to 25 per cent. These tests were nearly all made in freight service, at speeds under 30 miles per hour, and are regarded as conclusive proof of the economy of the compound in this kind of service.

One of the principal reasons put forth against the adoption of the compound is that owing to a supposed lack of power and efficiency at high speed, they could not be used indiscriminately in both freight and passenger service, should the conditions of traffic make it desirable; that the compounding of the cylinders pro-

duced in this and following tables were reduced to the same speeds of rotation, the actual tests being run at speeds varying slightly from the normal. The item "Miles Per Hour" was obtained by reduction to a basis of a 63-inch wheel, to facilitate comparison with a simple engine having wheels of that diameter. The figures given in the table are plotted in the form of a curve in Fig. 1.

It is interesting to compare this performance with that of a simple engine working under similar conditions. In Fig. 2 comparison is made with a 17x24-inch simple engine working in the first and second notches off center (cut-offs of approximately 6 and 8 inches), and with about the same pressure at the throttle. The curves show that after a speed of 230 r. p. m. is reached, the simple engine loses more in mean effective pressure by wiredrawing and imperfect distribution of steam in the cylinder than is gained by increase of speed, with the result that the net power is decreased.

In the compound, the loss of mean effective pressure with increase of speed is constant for all speeds tested, and the horse-power curve is a straight line up to 270 r. p. m. It is to be regretted that the plant did not admit of tests being run at higher speeds, which would have been the means of determining the point at which the power became constant or began to decrease.

In Table II, is shown the variation of steam con-

sumption per indicated horse power per hour, with increase of speed at different cut-offs:

TABLE II.

R. P. M.	Plat in Speed	Miles per hour.	Steam Consumption per I. H. P. per Hour.	10-in. Cut-off.	11-in. Cut-off.
100	300	18.7	23.7	28.7	23.1
170	510	30.2	23.1	23.3	23.3
230	690	43.1	22.9	21.7	22.9
270	810	50.6	22.7	20.9	20.9

These results are shown graphically in Fig. 3 in comparison with curves for a simple engine. It will be seen that the figures from the compound show higher economy in the use of steam than the simple engine;

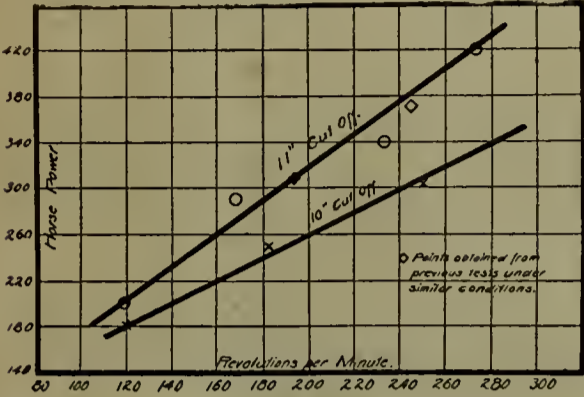

FIG. 1.

that not only is the best performance of the compound far better than the best performance of the simple engine, but that its average economy is also much higher than the best performance of the simple engine. They also show that the steam consumption decreases with an increase of speed within the limits of the test. The point of minimum steam consumption for the simple engine, about 180 revolutions per minute, has been called by Professor Goss the "critical speed."\* The curves show that for the 10-inch cut-off the critical speed of the compound is about 250 r. p. m., and for the 11-inch cut-off it is in excess of 270 r. p. m. This seems to indicate that the distribution of steam af-

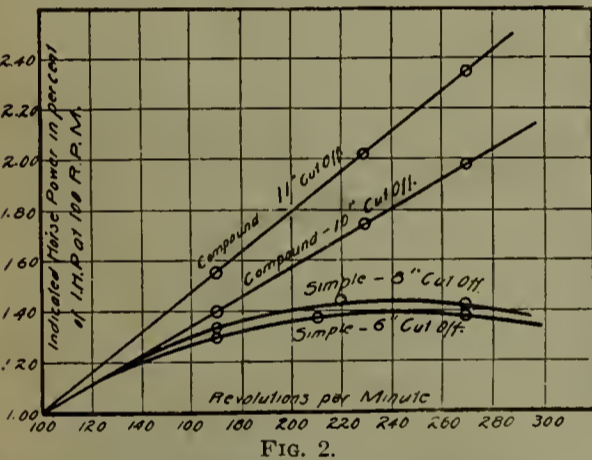

FIG. 2.

forded by the compound arrangement of cylinders is well adapted for use in connection with high speeds of rotation, and leads to the conclusion that the objections to the compound locomotive, previously mentioned, are not well grounded.

It is not within the province of this paper to assign reasons for the increase of efficiency of the compound locomotive with speed within the limits stated. Attention is called, however, to the following significant facts which may serve as a partial explanation.

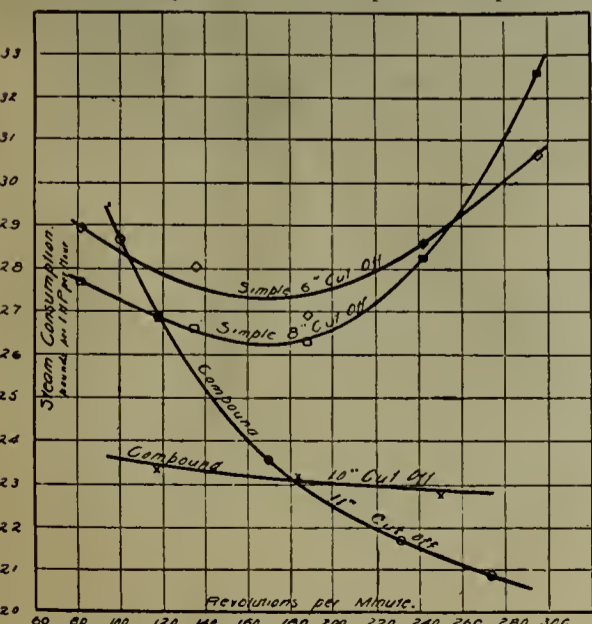

FIG. 3.

\*"Performance of the Purdue Locomotive, Schenckaday," a paper presented at the May, 1897, meeting of the Western Railway Club, by Professor W. F. M. Goss.

Cylinder condensation has an important effect on the economy of the steam engine and the change in the amount of this condensation under different conditions of running may be indicated, to a certain extent, by the change in the quality of the steam during expansion.

In Fig. 4 is shown the variation of the quality of steam at release with speed of rotation in the compound and the simple engine. The ordinates represent the percentage of the mixture in the cylinder, which is accounted by the indicator as dry steam. The figures from which the curve of the compound is plotted were taken at release in the low-pressure cylinder. The curves were inverted in plotting in order that their general form might be compared with the curves for steam consumption, Fig. 3. The coincidence in the form of these curves testifies to their correctness and points to the conclusion that a change in the economy of the steam engine will follow a corresponding change in cylinder condensation.

Attention has already been called to the fact that the steam pressure used was lower than that commonly employed with compound locomotives, and it was stated that a better performance might be expected with higher pressures. An inference as to the amount of gain in economy with higher pressures may be had by reference to Fig. 5, the figures for which were taken from tests made on the plant a year or two since.

The fact that the plant was run at a disadvantage through low steam pressure is in a measure offset by the fact that the back pressure for the tests was somewhat lower than that found in practice. This permits greater power to be developed in the cylinders, and would probably lead to a slightly lower steam con-

5. The results of extended investigations which have been carried on at Purdue have established certain relations existing between the rate of evaporation and the evaporative efficiency of a representative locomotive boiler. Basing the conclusion upon these results,

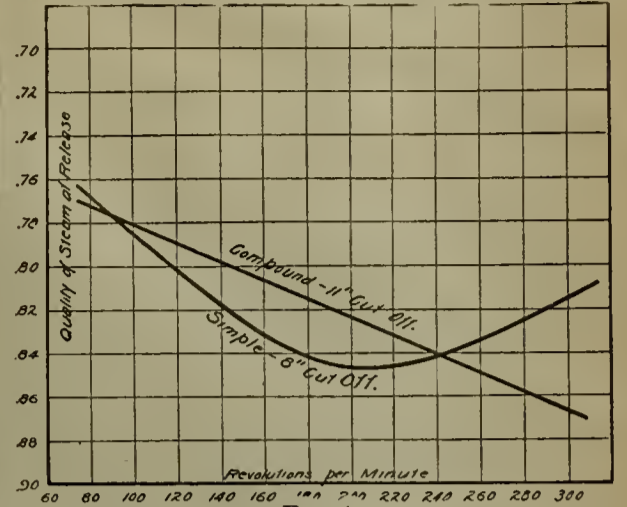

FIG. 4.

the saving in steam shown by the compound locomotive in the tests under consideration would result in a saving in coal of from 18 to 33 per cent.

APPENDIX I.

Describing the Plant and the Conduct of the Tests. The tests comprising the first series were conducted

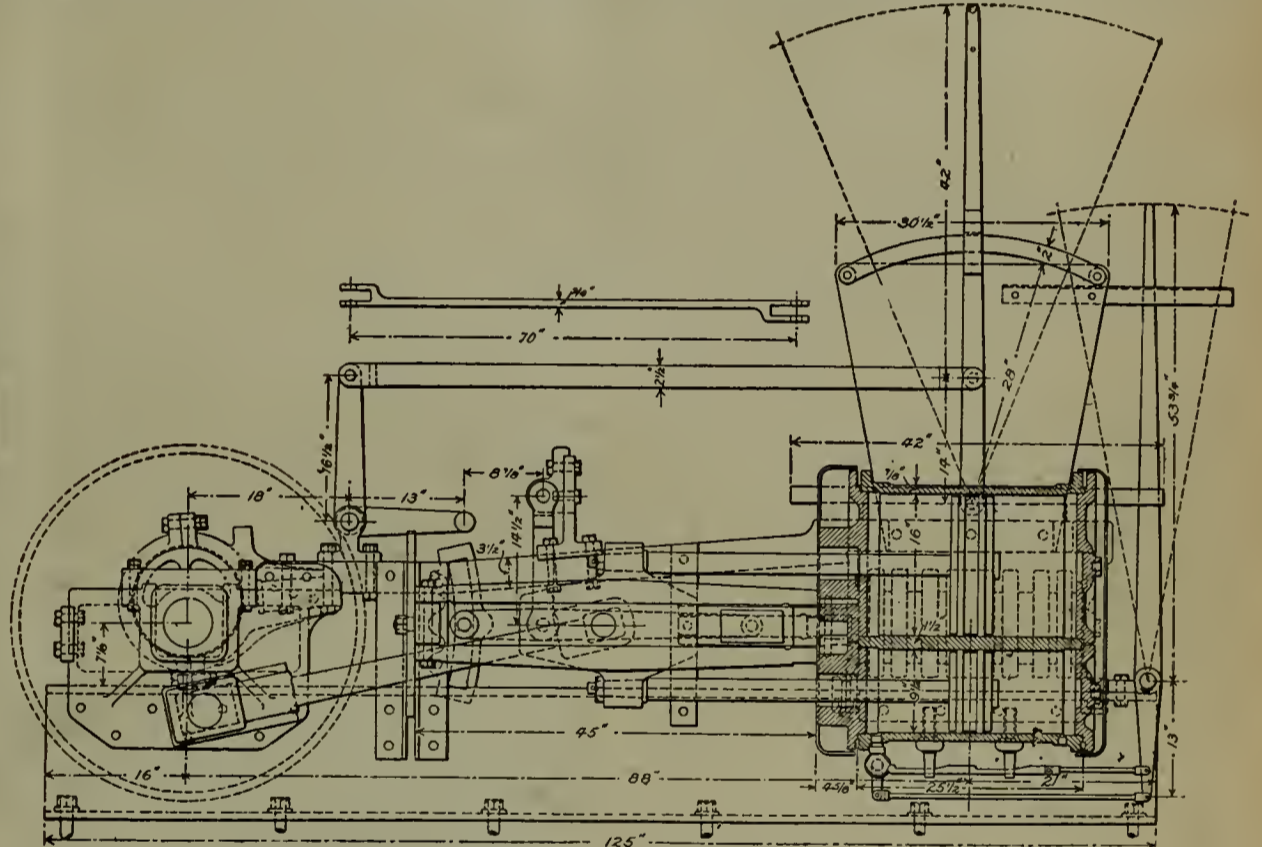

FIG. 6—VAUCLAIN COMPOUND APPARATUS AT PURDUE UNIVERSITY.

sumption. It would not, however, have an appreciable effect on the comparative results.

Conclusions.

1. The change in distribution of steam in the cylinders of a four-cylinder compound locomotive of the type experimented upon is such as to give, with increase of speed, increased horse power and economy up to 270 revolutions per minute.

2. The results indicate that the power will continue to increase for speeds considerably above 270 r. p. m.

3. The increase in economy with increase of speed is chiefly due to a decrease in cylinder condensation, as shown by the quality of steam at low-pressure release. The average steam consumption obtained for the compound is much lower than the lowest consumption shown by the simple engine. It is probable that under similar conditions of operation on the road the compound locomotive of the type under consideration will show a lower steam consumption for all speeds and cut-offs.\*

\*The fact that at the slower speeds and longer cut-offs, the curves in Fig. 3 show that the compound is less efficient than the simple, would seem to be in direct conflict with this conclusion and also with the results of many road tests in freight service.

It should be remembered, however, that while the tests of the compound were run under cut-offs approximating closely to those used in freight service, the cut-offs employed with the simple engine were such as are commonly employed in passenger service. Had the latter been run at longer cut-offs (those commonly employed in freight service), the steam consumption curves for the simple engine (Fig. 3) would have been moved up on the diagram, thus showing an advantage for the compound under all conditions of running.

by Messrs. J. B. Meriam and E. S. Cooper, under the personal direction of the writer. Those of the second series were conducted entirely by the writer.

The apparatus upon which the tests were made (Fig. 6) was made by the Baldwin Locomotive Works and constitutes a part of the permanent equipment of the

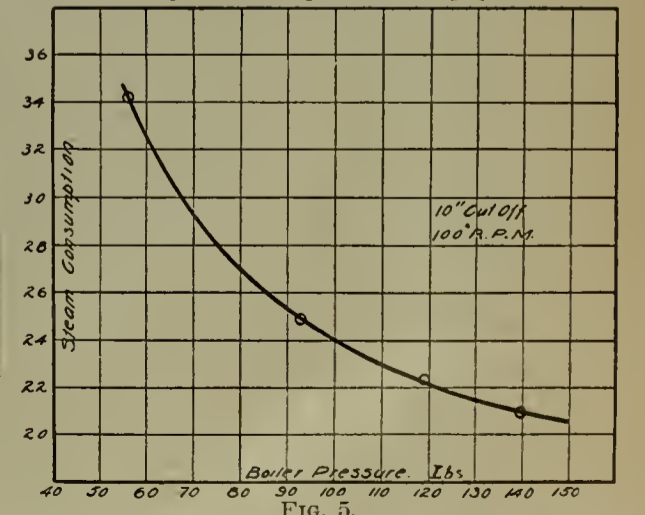

FIG. 5.

Engineering Laboratory. It consists of the cylinders, reciprocating parts, rods, valve gear and main drivers of a Vaucrain compound locomotive, mounted on a suitable frame, which is in turn secured to a heavy foundation in a manner similar to a stationary engine. The engines receive steam from a 250-horse power Stirling boiler. The power is absorbed by friction

brakes placed upon the axles and drivers. The exhaust steam is piped to a Wheeler surface condenser, where it is condensed at atmospheric pressure and then led to suitable weighing barrels.

The principal dimensions of the engines are given in the subjoined table:

	H. P.	L. P.
Diameter of Cylinder, inches	9.5	16
Length of Stroke, inches	18	18
Clearance, per cent of stroke.		
average	22.6	12.3
Steam Lap	1/2 inch	1/2 inch.
Exhaust Lap	1/8 inch clearance	0
Cylinder ratio	1	to 2.88
Diameter Drivers, outside, inches	44	
Diameter valve, inches	7	

In view of the limited steam supply and the difficulty attending the absorption of large powers, but one side of the plant was tested: the right pistons were disconnected from the crosshead and the steam and exhaust passages on that side were closed with blank flanges. Cast iron weights were bolted to the right crosshead to maintain the horizontal balance.

The tests were made with flying start, the engines having been run twenty to thirty minutes before the test commenced. They were about one-half hour in duration. The use of the surface condenser and weighing barrels for measuring the amount of steam used permitted the test to be of shorter duration than would have been necessary had the steam consumption been determined in connection with a boiler test. Four indicators were used and the connections to the cylinder were short. This, with a carefully designed indicator ring, insured accurate indicator cards.

APPENDIX II.

Summary of observed and calculated data.

Test No.	1	2	3	4	5	6	7
Date of Test	4-9-'97	4-9-'97	4-2-'97	12-18-'97	12-18-'97	12-23-'97	12-18-'97
Duration of Test, minutes	40	40	25	24	30	30	30
Position of Reverse Lever, notches off center	1	1	1	2	2	2	2
Cut-off, H. P., in per cent of stroke	60.1	60.0	63.0	64.6	63.1	68.0	68.4
Cut-off, L. P., in per cent of stroke	51.2	52.0	52.1	65.5	64.4	67.4	65.8
Release, H. P., in per cent of stroke	91.2	88.3	87.0	82.8	84.4	84.4	88.3
Release, L. P., in per cent of stroke	85.2	82.0	82.1	91.0	87.1	88.4	89.8
Compression, H. P., in per cent of stroke	21.0	17.2	17.0	15.3	14.6	14.8	15.1
Compression, L. P., in per cent of stroke	23.0	23.1	23.4	26.8	25.8	17.4	28.2
Total Number of Expansions	4.78	4.78	4.78	4.46	4.55	4.23	4.20
Revolutions per minute	117.	182.	250.	118	168	233	273.
Steam Pressure	146.	140.	141.	133	145.	136.	140.
Pressure under Throttle	145.	139.	140.	129.	132.	132.	131
Mean Effective Pressure, H. P.	56.24	47.75	43.33	62.23	60.99	60.15	53.8
Mean Effective Pressure, L. P.	26.39	21.00	18.24	28.69	26.61	19.20	23.40
Indicated H. P. (one side)	98	124	151	99.9	145.6	168.9	210.7
Total Weight of Steam (one side)	2288	2888	3440	1039	1706	1841	2124
Steam per 1 H. P. per Hour, pounds	23.43	23.27	22.74	26.9	23.50	21.67	20.82
Per Cent of Total Power developed in L. P. Cylinder	57.4	55.8	54.8	52.6	55.6	48.0	55.2

STEAM WRECKING CRANE—A. T. & S. F. RY.

The Atchison, Topeka & Santa Fe Railway recently received from the Bucyrus Company, of South Milwaukee, Wis., a 35-ton steam wrecking crane, an illustration of which is given herewith. This crane is designed on the lines of an elementary crane, or derrick, with straight boom, simple A-frame and back guys, and mounted on a steel car of great weight and strength. The car floor is a rigid foundation upon which the superstructure is built, and the strains are all taken in a simple and direct manner on straight lines and pin connections. Both machines can swing the boom through a half-circle, and ample stability is provided.

The boom has ample clearance to lift a box car and place it on top of a flat car alongside. The boom can be made curved, or arched if required, but the straight boom is preferred by the makers on account of simplicity and strength and the absence of bending strains. The same clearance is obtained with the straight boom as with a curved boom, and at the same time greater head room is given for the blocks.

The jack-arms fold up against the A-frame when not in use. This is done by the power of the hoisting engines, applied through small block and tackle for the purpose. They are pin-connected, with tension and compression members of ample strength. The front end of the car is carried on eight wheels, with two pairs of heavy all-steel diamond trucks. These two trucks are equalized to a common center bearing by means of a heavy steel equalizing frame carried between the sills of the car, and sufficient flexibility is obtained to pass a 16-degree curve. The axles are M. C. B. standard for 80,000 lbs. ca-

capacity, and have journals 5x9 inches. The total weight of the machine is 136,000 lbs., so that the weight per journal is 11,333 lbs., or 296 lbs. per square inch. This very moderate pressure enables the machine to be run over the road at high speed without risk of hot boxes.

The load can be hoisted and swung through an arc of 180 degrees. The crane can lift the maximum load at full radius within an arc of 50 degrees, each way from mid-position when standing on the jack arms, and can lift and swing the maximum load through 180 degrees when the car is anchored down. The clear height to the top of the A-frame from rail is 17 feet 6 inches when the boom is lowered. For the purpose of lowering the boom for transportation the front guys are formed with a rear extension, so that they may be pin-connected to the A-frame in two positions. The raising and lowering of the boom is done by power by means of a snatch block attached to the A-frame for that purpose. The operation of changing the boom from high to low position is thus accomplished easily and quickly, and the guys are carried during the operation by lugs suitably formed on the A-frame head.

An auxiliary hoist is provided for handling light loads at a rapid speed, and this has a reach of 75 feet away from the machine.

Two winch heads are provided, one on either side of the car outside in convenient position for general hauling and warping purposes, and snatch blocks are placed in convenient position on both ends of the car. All this means that a great variety of hoisting and hauling can be done without interfering with the main lift, and the machine can also be hauled along the track by these appliances, if desired.

The construction of the machine throughout is so

provided for this purpose. The following are the specifications of the car in abstract:

GENERAL SPECIFICATIONS.

Car Frame.

Ten inch wide, 42' long; six 15" steel channels, 80,000 lbs. per foot.

Trucks.

All-steel diamond pattern; two pairs under front end with equalizing beams. Arch bars 1 1/2"x4". Center bearings of cast steel. Axles M. C. B. Standard, 80,000 lbs. capacity. Journals 5"x9". 33" McKee-Fuller steel tired wheels. Rear end of car supported on one four-wheel truck of same construction throughout.

A-Frame.

Of structural steel, with cast steel head, and feet, pin-connected. Eye bolts and rings at top of A-frame for attachment of side guys when required.

Boom.

Thirty-three feet long, formed of two 15" steel channels, plated top and bottom so as to form a solid box girder of ample strength. Boom guys and back guys of solid forged steel. Eye bars of such sectional area that they will not be strained to more than 12,000 lbs. per square inch with maximum load.

Main Hoist.

Twenty-two feet 6" radius, 18 ft. clear height from rail to hook. Angle of swing 180 degrees. Capacity 70,000 lbs. through an arc of 100 degrees when standing on jack-arms and through 180 degrees with side guy to top of A-frame. To swing 20 tons through 180 degrees when standing on jack-arms without side guys. Six parts one inch diameter crucible steel wire rope, running in 24" turned sheaves. Steel hook 40 tons capacity, having opening 10" diameter. Speed of lift, 10 feet per minute. Length of rope sufficient to allow hook to reach rail, and to hoist to 18 feet clear.

Auxiliary Hoist.

Three parts 1 1/4" diameter manilla rope. Rope long enough to reach 75 feet from point of boom.

Swinging Motion.

Two crucible steel wire ropes, one inch diameter, connected to drum and provided with brake.

Winch Heads.

Two removable winch heads fitted to cross shaft

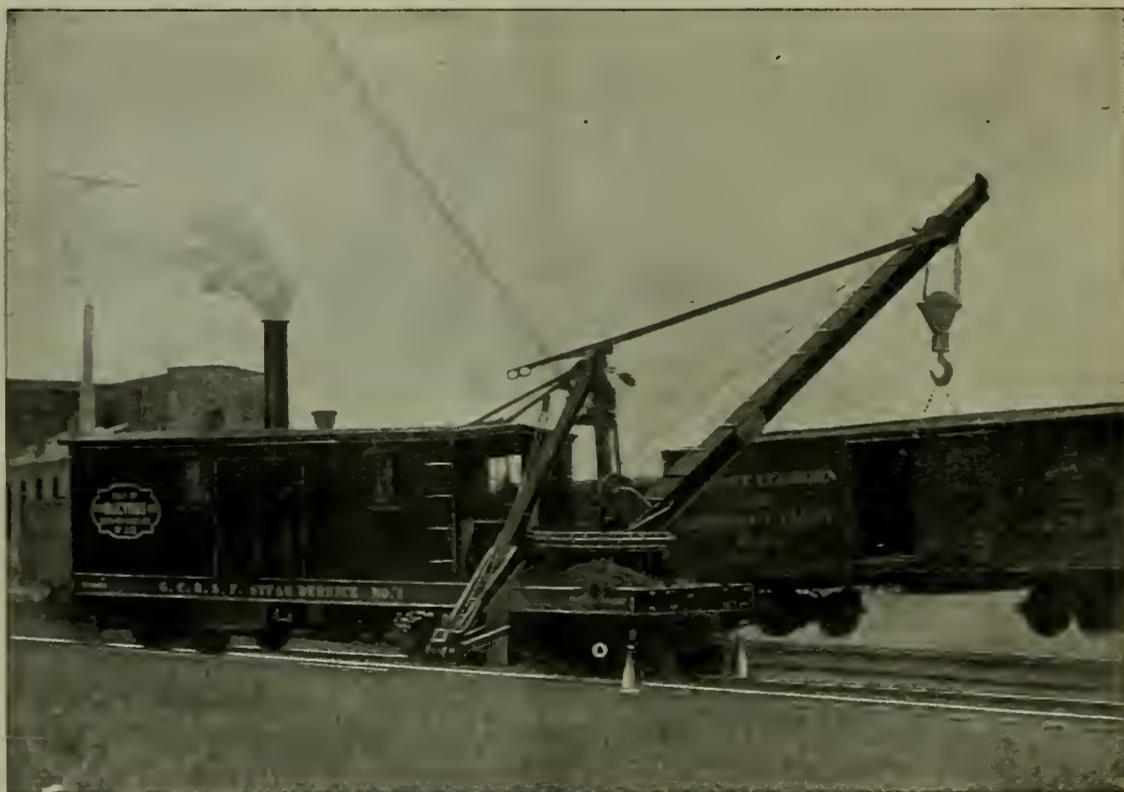

STEAM WRECKING CRANE—A. T. & S. F. RY.

strong that it cannot be injured by any kind of abuse. The machine is furnished with a full equipment of tools and appliances for its operation and it is said of it that it can be handled and got ready for action in less time than any other. Special attention has been paid to the swinging power of the machine. This is gained by steel wire ropes wrapped around a swinging circle of large diameter and carried to a drum. The power is sufficient to swing the load up hill if the machine should not be on level track, and a brake is provided which will hold it in any position while being hoisted or lowered.

Ample stability is obtained for all ordinary loads by means of jack screws and rail clamps attached to the body of car. It is only necessary to let down the jack-arms when heavy loads are to be lifted and swung to the side. For lifting the maximum load in extreme side position it is necessary to still further anchor the machine by means of side guys to the top of the A-frame, and ring bolts are there

under body of car. Two snatch blocks attached to car body for leading rope.

Jack-Arms.

Two steel jack-arms hinged to base of A-frame in such a manner that they can be folded up against it when not in use, and small tackle attached to car frame for raising and lowering them. Jack-arms pin-connected to top and bottom members of transverse truss over forward truck center to form a continuation of the truss, so that the support of the jack screws is directly transmitted to the A-frame without straining the body of car. Screws of hammered steel 4 1/4" diameter, 19' 0" apart centers. Two additional screws under front of car and hinged so that they can be hung out of the way when not in use.

Rail Clamps.

Four rail clamps of Bucyrus standard for anchoring car: two at front end and two at rear. Arranged to hang up when not in use and having screw adjustment to floor of car.

Engines.

8"x12" Double. All gearing of cast steel. Link motion reversing gear.

Boiler.

Of locomotive type, 45" diameter by 10' 3" long.



100 lbs. working pressure. Boiler lagged with steel and furnished with independent feed pump, injector and all usual fittings.

The water tank has 600 gallons capacity. A full equipment of blocks, rope, grapple chains, tongs and tools is provided. The car is fitted with Trojan couplers, Westinghouse brakes, National Hollow brake beams, McCord journal boxes and McKee & Fuller steel tired wheels.

**VALVE STEM MOTION—NORTHERN PACIFIC RAILWAY.**

In the use of piston valves of the class designed by Mr. H. H. Warner, master mechanic of the Pacific division of the Northern Pacific, (illustrated in our issue of February, 1898), it is desirable to have the pull and thrust motion on the valve stem made in as straight a line as possible. Guides at the front end of the valve, whose stem is elongated for this purpose, are used in the case of large valves. Mr. Warner's design, shown herewith, effectually and neatly overcomes the distorted thrust of the stem which the usual rocker connection necessitates and

a freight train, varies the degree of braking force sufficient to cause destructive shocks to lading and equipment.

"In Fig. 2 advantage has been taken of the entire circle to make the divisions as large as possible. Further, the numerals which register abnormally low and abnormally high pressures have been neglected; yet they are left on the dial in case they may be needed. This has been accomplished by causing the pointers to make more than one complete revolution. In fact, two revolutions can be made. The stop pin is inside of the gage, and only stops the hands at zero. Both pointers start at zero in the outer circle, and continue around together until 70 is reached. Then the train line pointer stops as in the ordinary gage, and the main reservoir pointer goes on around to 90, the standard main reservoir pressure; but will go higher if more pressure is carried. Notice the relative position of the two pointers. They are at right angles, and as the divisions between numerals are nearly four times as great as those on the ordinary gage (Fig. 1), any variation from these pressures will be noticed much more quickly than with the ordinary gage.

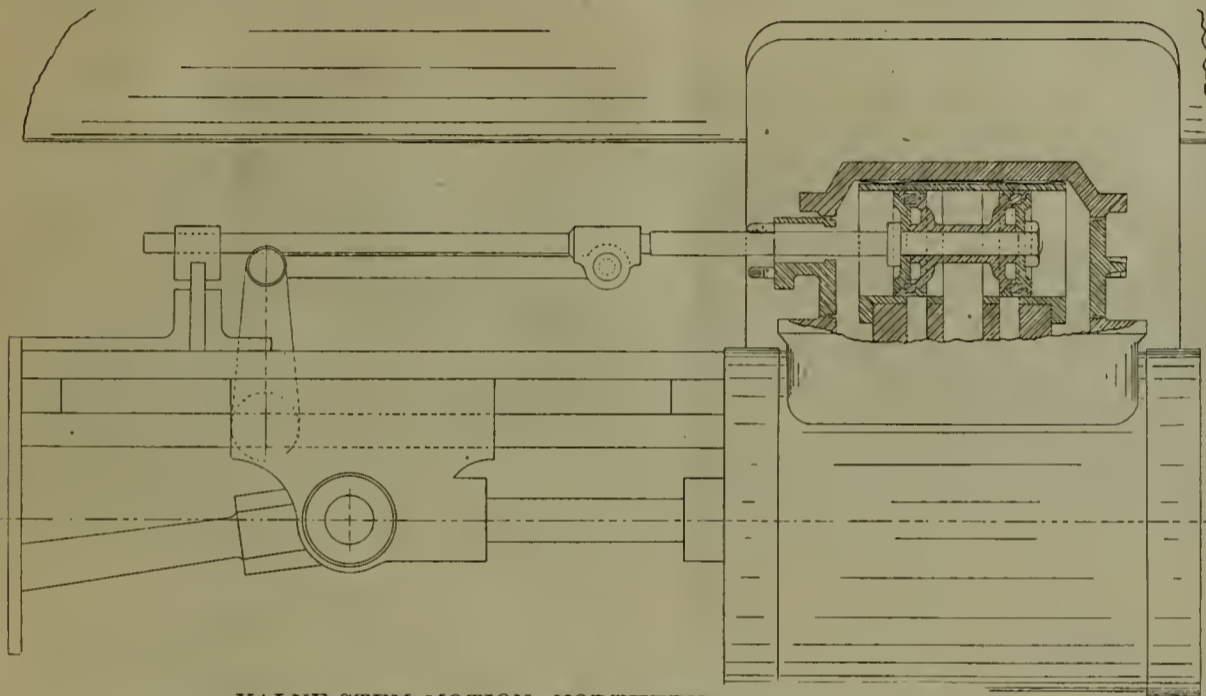

VALVE STEM MOTION—NORTHERN PACIFIC RAILWAY.

which is felt seriously in the case of the piston valve because, perhaps, of its almost perfect equilibrium in natural motion. Our engraving shows very clearly how Mr. Warner gets at the problem. Such a connection, on the back end of the valve stem, is very desirable, especially in the absence of a front guide.

**THE "SEMAPHORE" AIR GAGE.**

Messrs. F. M. Nellis and S. D. Hutchins, of New York city, have recently patented an interesting air brake device in the shape of the pressure gage shown by the accompanying engravings. They send to us the following description of the device:

"The improvement in this gage consists of a better arrangement of numerals on the dial, whereby the pressures for train braking is read by the engineer similarly as he reads the semaphore signal, by position instead of numerals. The form of the glass face is also an improvement. The mechanism, with slight modification, is the same as that of other gages of the well known Bourdon tube type.

"Reference to Figs. 1 and 2 in the illustrations will show, by comparison, the superiority of this improved gage over the old form for air brake practice. Fig. 1 illustrates the form of gage almost wholly used. The numerals are zero to 160, inclusive. These divisions occupy less than three-fourths of the entire circle. Again, very little use exists for those numerals below 40 and those above 120. They are so secondary in importance to the numerals which register the real working pressures, that we could, without any inconvenience to the engineer, do away with them. Here is over half the circle either wasted or uselessly employed, and the most important divisions and numerals are crowded into such a small space that an engineer cannot tell accurately whether he is reducing one or three pounds. A pound too little, or a pound too much, in making the initial reduction to take up the slack in

"It may be brought up as an objection to the improved gage, that the two sets of numerals might confuse an engineer—that he would not know, for instance, whether the main reservoir pointer was registering 90 pounds or 10 pounds. If the objector stops to think he will know that the main reservoir hand could not register 10 and the train line hand register 70 pounds. And this would be true for all other positions. The large size numerals are the only



FIG. 1.



FIG. 2.

THE "SEMAPHORE" AIR GAGE.

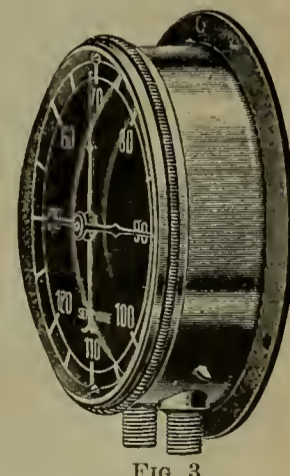

FIG. 3.

ones with which the engineer is concerned. The others are merely retained for the use of the round-house machinist, and are so small that the engineer will not see them from his seat box.

"The best and most important feature of the improvement remains yet to be pointed out, viz: All train braking is really done between 70 and 50 pounds. The pointer, at 70, indicates maximum train-pipe pressure. At 50, it shows that brakes are fully applied, and that any further reduction is purely a waste of pressure. All work is therefore done in one quadrant, and is marked by the posi-

tion of the pointer, similarly as the semaphore signal communicates with the engineer, who becoming accustomed to the gage, will brake from the position of the pointer rather than depend upon the numerals. As a test of this principle, an engineer ran for three months with a "semaphore" gage, on whose dial were only three numerals—50, 70 and 90. He was loud in praise of the new principle.

"Fig. 3 is almost a side view of the improved gage. The convex, or watch crystal shaped glass, without any rim, makes the position of the hands plainly visible even in this position. The face is black enamel. The train line pointer is white, and the main reservoir hand is red. This, as engineers know, is a much better combination than the polished face which glares in a bright light. The usual large opening in the middle of the dial has been closed. All lettering, except the word "Semaphore", the name given the new gage, has been stricken from the dial, thus bringing into greater prominence the movement and position of the pointers. The train line pointer lies nearest to the dial, which is the reverse of the case with the ordinary gage, and reads nearly as true from the side as from the front position.

"Air gages, as ordinarily furnished by the manufacturers, are merely instruments for recording press carried. They are identical with steam gages, except that they have two hands and two mechanisms. A gage for air-brake service must be something more than a mere pressure-recording instrument. It must be a pressure-reducing gage. It must plainly show small reductions on which communication handling so much depends, and must communicate accurately, clearly and quickly, to the engineer, the state of his pressure. The "Semaphore" air gage is being manufactured by the Star Brass Company of Boston, Mass., and the Ashcroft Gage Company of Bridgeport, Conn."

**A NEW BALDWIN MOTOR CAR.**

The Baldwin Locomotive Works have just built a motor car for the Cincinnati, Hamilton & Dayton Traction Company. It is of the now familiar type of inclosed motor. The car body is 32 feet 9 inches over all and is divided into passenger, baggage, and engineer's compartments. The passenger compartment, which has a seating capacity for twenty-four persons, is finished in quartered oak, and is provided with transverse seats with an aisle in the center. The passenger compartment is heated by steam and well lighted. Windows are provided with sash and spring rollers. All trimmings are of bronze metal. A toilet room is located at one end of this compartment. Safety gates are provided at the sides of the back platform. The baggage compartment is about six feet long and located between the engineerroom and passenger compartment, with both of which it communicates.

A condenser is attached to the roof of the car into which all the steam from the cylinders may be diverted. Two tanks, each with a capacity of 150 gallons, are placed under the car body, from one of which the feed water is taken, whilst the other, being connected with the condenser, receives the water formed by the condensing steam; but both these tanks are connected and supply the feed water to the boiler.

The frames supporting the cylinders and driving mechanism are embodied in a swivelling truck

which forms a support for the forward end of the car. The steam pipe connecting the steam chest with the boiler is provided with flexible metallic joints to allow for the lateral motion of the cylinders caused by the swiveling motion of the truck. A four-wheeled swiveling truck acting simply as a carrier is placed under the rear end of the car and is provided with wheels 30" in diameter and axle journals 3½"x7".

The fuel is to be anthracite coal or coke. The weight in working order, not including passengers, is about 48,000 pounds, with about 32,000 pounds on the driving wheels. The cylinders are of the Vaucrain compound type, high pressure 5½" in diameter, low pressure 9" in diameter, and stroke 12". The driving wheels are 30" in outside diameter. The total wheel base is 16' 8"; and driving wheel base, 5' 0". The driving axles are of steel, with journals 5"x6". The driving boxes are of brass. The boiler, 48" in diameter, is centrally fired, and is of the self-feeding type, being supplied with coal from the top of the car roof around the stack through a 10" pipe in the center of the boiler. The boiler is constructed of steel ½" thick, and carries a working pressure of 180 pounds to the square inch. The tubes, of iron, are 304 in number, 1¼" in diameter, and 5' long. The fire box is 42¾" in diameter and 22" deep. The fire box is provided with 12 circulating tubes in the lower tube sheet, 2" in diameter and 8" long, which guide the coal to the center of the fire box, and also provide extra heating surface. The car is provided with American vacuum brake equipment on both driving and truck wheels.

The car was tested on the tracks of the Philadelphia & Reading Road, and in addition to its own weight, pulled a box car loaded with oats, running a distance of 38 miles at speed varying between 30 and 40 miles an hour. The fire required no attention and received none during the entire run of 38 miles. The operation of the car was more free from noise than the ordinary trolley at that speed; it rode as smoothly as a Pullman car, and the examining engineers made a very flattering report of its capacity in every way. The second test was made on the tracks of the Cincinnati, Hamilton & Dayton Railway Company on February 22, with equally satisfactory results.

**FREIGHT LOCOMOTIVE—B. & M. RY.**

The Boston & Maine Railway is having built at the Schenectady Locomotive Works a lot—ten—of ten-wheel compound locomotives for use in freight service. These locomotives are from drawings and specifications prepared by Mr. Henry Bartlett, superintendent of motive power of the Boston & Maine road. These engines will be placed in freight service on the Concord and White Mountain divisions of the road, both of which are more or less hilly. Four of these engines were delivered some weeks ago and in entering service gave promise of very satisfactory results. The general appearance of the engine is well revealed by our illustration, and the appended specifications give all essential details of design and construction:

**GENERAL DIMENSIONS.**

Gauge.....4 ft. 8½ in.  
Fuel.....Bituminous Coal.  
Weight in working order.....141,000 lbs.  
Weight on drivers.....103,000 lbs.  
Wheel base, driving.....14 ft.  
Wheel base, rigid.....14 ft.  
Wheel base, total.....24 ft. 5 in.

**CYLINDERS.**

Diameter of cylinders.....H. P. 21, L. P. 32 in.  
Stroke of piston.....26 in.  
Horizontal thickness of piston.....5¾ and 4¾ in.  
Diameter of piston rod.....3½ in.  
Kind of piston packing.....C. I. rings.  
Kind of piston rod packing.....U. S. metallic.  
Size of steam ports.....  
.....H. P. 20 in. x 2½ in. L. P. 23 in. x 2½ in.  
Size of exhaust ports.....H. P. 20x3 in. L. P. 23x3 in.  
Size of bridge ports.....1¾ in.

**VALVES.**

Kind of slide valves.....Allen-Richardson, balanced.  
Greatest travel of slide valves.....6 in.  
Outside lap of slide valves.....H. P. 1¼ in. L. P. 1½ in.  
Inside lap of slide valves.....¼" clearance  
Lead of valves in full gear.....  
Kind of valve stem packing.....U. S. metallic.

**WHEELS, ETC.**

Diameter of driving wheels outside of tire.....63 in.  
Material of driving wheels centers.....  
.....Main, cast steel F & B steeled cast iron  
Tire held by.....Shrinkage.  
Driving box material.....Gun iron.

Diam. and length of driving journals, 8 in. dia. x 10 in.  
Dia. and length of main crank pin journals.....  
.....Main side, 6¼"x5¼"; main 5½ in. dia. x 6 in.  
Diam. and length of side rod crank pin journals...  
.....F. & B. 4½ in. dia. x 4 in.  
Engine truck, kind.....4-wheel, swing bolster.  
Engine truck journals.....5½" in. dia. x 10 in.  
Diam. of engine truck wheels.....30 in.  
Kind of engine truck wheels.....  
.....Standard, O. H. steel tired, spoke center.

**BOILER.**

Style.....Extended wagon top.  
Outside diam. of first ring.....58 in.  
Working pressure.....200 lbs.  
Material of barrel and outside of fire box, Carbon steel.  
Thickness of plates in barrel and outside of fire box...  
.....9-16", ¾", 11-16' and ½ in.  
Horizontal seams.....  
Butt joint, sextuple riveted, with welt strip inside and outside.  
Circumferential seams.....Double riveted.  
Fire box, length.....96 in.  
Fire box, width.....42¼ in.  
Fire box, depth.....F 70 in. B 61 in.  
Fire box, material.....Carbon steel.  
Fire box, plates, thickness.....  
.....sides, ¾", back, ¾", crown, ¾", tube sheet, ½".  
Fire box, water space.....4" front, 3½" sides, 3" back.  
Fire box crown staying.....Radial stays, 1" and 1½" dia.  
Fire box, stay bolts.....Ulster special iron.

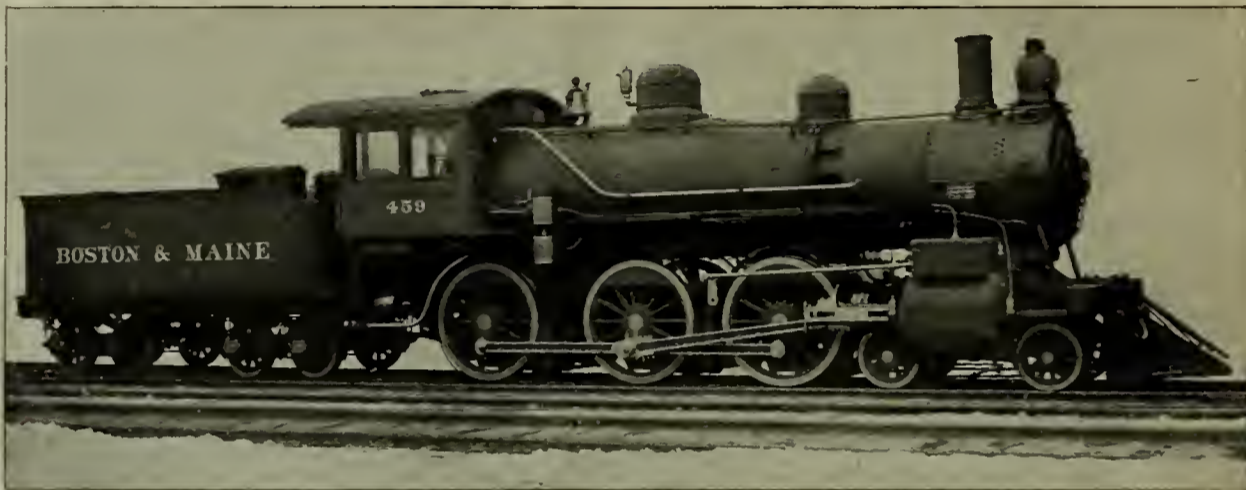

FREIGHT LOCOMOTIVE—BOSTON & MAINE RAILWAY.

Tubes, material.....Charcoal iron No. 12 B. W. G.  
Tubes, number of.....267  
Tubes, diameter.....2 in.  
Tubes, length over tube sheets.....13 ft. 4 in.  
Fire brick, supported on.....Studs, company's style.  
Heating surface, tubes.....1852.33 sq. ft.  
Heating surface, fire box.....141.4 sq. ft.  
Heating surface, total.....1993.73 sq. ft.  
Grate surface.....27.39 sq. ft.  
Grate, style.....

Finger type, rocked in two sections R. R. Co.'s style.

Ash pan, style.....Hopper  
Exhaust pipes.....Single.  
Exhaust nozzles.....5", 5¼" and 5½" dia.  
Smoke stack, inside diameter.....15½ in.  
Smoke stack, top above rail.....13 ft. 9 in.  
Boiler supplied by 2 Hancock type "B" improved inspirators, size No. 8.

**TENDER.**

Weight, empty.....34,000 lbs.  
Wheels, number of.....8  
Wheels, diameter.....33 in.  
Journals, diameter and length...4¼ in. dia. x 8 in.  
Wheel base.....15 ft. 8 in.  
Tender frame.....8" steel channel.  
Tender trucks, company's style, arch bar type, wood bolster, side bearing.  
Water capacity.....4,000 U. S. gallons.  
Coal capacity.....8 tons.  
Total wheel base of engine and tender. 49 ft. 11¼ in.  
Total length, base of engine and tender. 59 ft. 4½ in.

**SPECIAL EQUIPMENT.**

Engine equipped with two 3" Ashton safety valves; one Seibert triple and one Nathan triple sight feed lubricators; American outside equalized brake on all drivers; Westinghouse automatic air brake on tender and for train; magnesia lagging on boiler; National hollow brake beams; 16" round case headlight; Crosby No. 3, 5" chime whistle; Crosby thermostatic steam gauge; Consolidated steam heating apparatus.

**OIL IN STEAM BOILERS.**

One of the principal problems yet remaining unsolved in connection with the economical generation of steam is that of the use of condensed steam as feed for boilers without the injurious effects of the oil carried over from the lubrication of the engine in which the steam was used. There is a manifest economy in the condensation of steam, and much of

the advantage gained by multiple expansion would be lost if the expansion could not be carried below the pressure of the atmosphere. Surface condensers are undoubtedly the best means of accomplishing this end, and the condensed steam makes an admirable feed water for the boiler, except when it contains such a quantity of oil as to cause deposits of non-conducting material upon furnace flues and fire-box sheets. Even a thin film of grease upon the plates of a boiler furnace will keep the water out of contact with the metal, and many furnaces, both corrugated and plain, have gone down from this cause.

The extending use of sight feed lubricators and the feeding of the oil into the steam is well known, and if we remember that all the lubricant which goes into the steam inlet must also go out with the exhaust into the condenser, and so back into the boiler, we must take into account the effect which this quantity of grease will have upon the boiler furnace plates, which are so dependent upon the protection of the water to prevent over-heating.

Many of the great ocean liners, which must use the condensed steam in order to avoid filling the boilers with salt water, use filters to extract the grease from the water before it reaches the boilers

at all. Various filtering mediums are used for this purpose. On some of the Sound steamers straw or hay is used, while in other instances cast iron boxes tightly packed with sponges have been tried. On the White Star steamers the Edmiston filter is used, the oil in this case being extracted by diaphragms of woven filtering materials, compressed between perforated metallic plates, and this form of grease filter has been highly recommended. For land purposes, where space is not such an important consideration as at sea, both sand and coke have been used, and there is no doubt that by use of a sufficiently thick layer of such materials, and by frequent renewals, much of the grease from condensed steam may be removed and the water made fit for boiler feed purposes.

Where there is lime in the feed water the presence of oil in the boiler is especially objectionable, as a soft, spongy mass is formed, which collects upon crown sheets and flues, often with most disastrous results.

There are two points in this matter which if observed would enable much of the trouble to be avoided, and that, too, without involving recourse to any special appliances. In most instances far too much oil is fed into the steam, and the engines would work all right with very much less oil than is usually fed to the cylinders. A good quality of oil should be used, but the quantity fed should be made a minimum, not only for economy in first cost, but also for protection to the boilers. In nearly every case a most wasteful excess of oil exists, and there is loss at one end from excessive oil bills and at the other end from damaged boilers. In one well-known instance a careful engineer was using eight drops of oil to one revolution of the engines, and it was found that this could safely be reduced to one drop to eight revolutions without injury to the cylinders from insufficient lubrication.

Another point is to be noted in regard to the character of the lubricant. The high grade cylinder oils are supposed to be made from mineral sources and to contain no animal matter. Now kerosene oil and its derivatives are found not to be injurious to steam boilers, but on the contrary are frequently in-

roduced in order to loosen boiler scale and prevent its formation. The principal difficulty occurs with the small percentage of animal oil, which in order to improve the lubricating qualities is often mixed with cylinder oils. Animal oil should never be permitted to enter the boiler, and the lubricant used in condensing engines should be carefully examined, and the absence of animal oil assured. When this is done, and when, by close and careful experiment, the very least quantity of lubricant possible is used in the cylinders, the best precautions against injury to the boilers will have been taken.—The Engineer, New York.

**REMOVABLE BOILER COVERING—NORTHERN PACIFIC RAILWAY.**

One of the best of the "new things" that has recently come to our attention is a method of so covering locomotive boilers as to permit of easy examination of stay bolts. This method permits the use of a removable lagging, and is employed upon the Northern Pacific railway upon all classes of locomotives. It is described in the American Engineer, from whose columns we abstract the substance of the following notes and whose engraving we reproduce. The plan consists in putting on the lagging over the firebox, both inside and outside the cab, from the running board on one side to the same level upon the other side, in removable sections. The lagging is made up in rectangular panels, three of which attached at their ends extend over the firebox between the running boards. The sections are framed in 1 1/4 by 1 1/4 by 1/4-inch angle irons, secured at the corners by 1/4-inch iron gussets, riveted to the angles. The two side courses are of fire felt 1 1/4 inches in thickness, while the longer course, going over the top of the fire-box, is made of the ordinary lagging with a sheet covering. The attachment of the sections is made by means of hooks riveted to the sheets, and attachments to the running boards are made by means of bolts and lugs, which may be tightened to any desired extent.

In order to prevent the fire felt from falling out of the frames when removed wire netting of 1-16-inch soft iron wire with 3 by 3-inch meshes is woven into the angle iron frames, 1/4-inch holes being drilled through the angles for this purpose. The lengths of the sections of removable covering vary with the different types of engines, and this dimension is shown at "A" "A" in the drawing. (The portion inside of the cab is put on separately, and when three feet or less in width two hooks are used, as shown in the drawing.) For the covering outside of the cab, when the distance "A" is less than 4 feet 6 inches the removable covering is made in one sec-

distance exceeds 4 feet 6 inches the covering is made in two sections and secured as shown in the drawing. At the vertical joints between the sec-

when holes are punched at the ends of the plunger. The face or bottom of the plunger is 30" long, a length sufficient for considerable gang work and

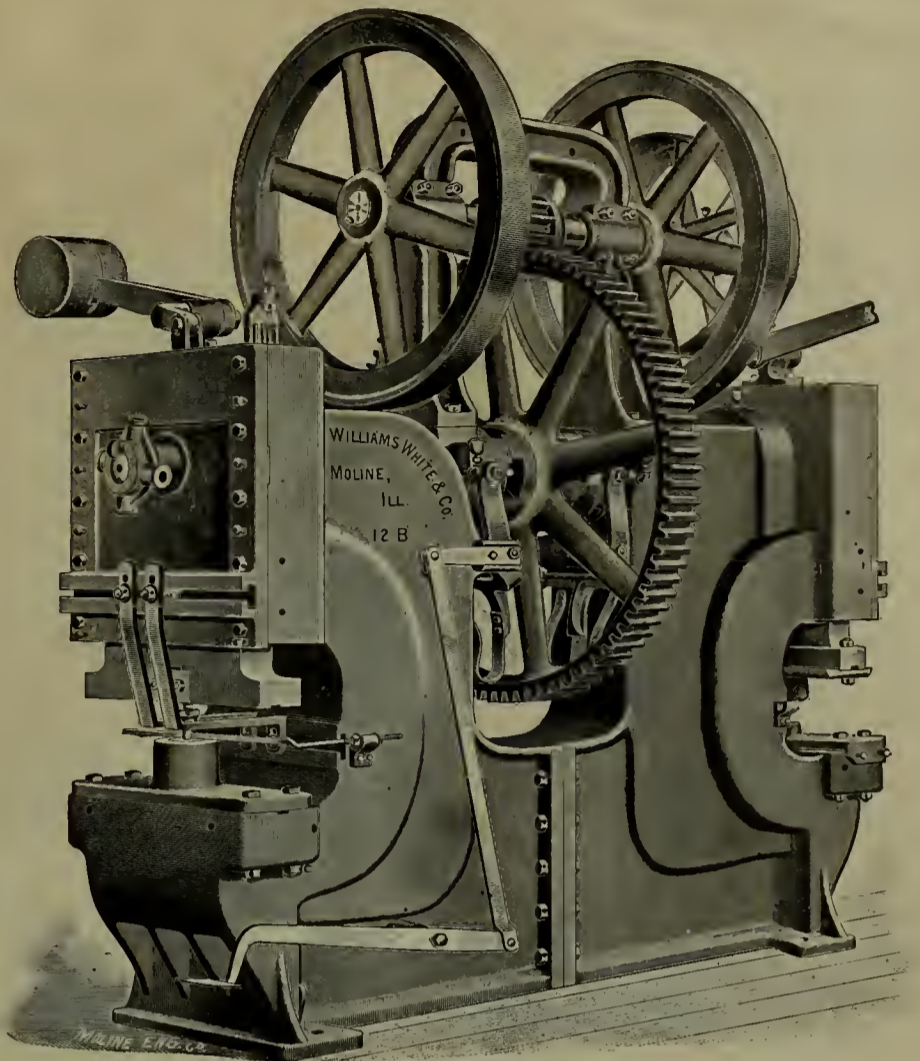

SPECIAL PUNCHING AND SHEARING MACHINE.

tions, covering strips are provided, which are connected by hooks similar to those used in connection with the sections themselves.

**A SPECIAL PUNCHING AND SHEARING MACHINE**

The accompanying illustration shows a heavy double ended punching and shearing machine of the usual type, with some special features, fitting it for

long shearing cuts. \* \* \* \* It will also be noted that the stripper is adjustable along the face of the machine, and that the punching is not necessarily confined to the center of the plunger. Other strippers can also be put on, so as to punch several holes at a time.

A great deal of gang work can be done in railroad, car and other shops on a machine of this character, which is now punched one hole at a time.

The manufacturers make these machines of a particularly high grade of iron, which is sometimes known as semi-steel.

The weight of the machine in question here illustrated is 30,000 lbs. Further information may be had from the manufacturers—Williams, White & Co., Moline, Ill.—who make these machines in all sizes.

**THE NEW COMPOSITE BRAKE-SHOE.**

We show herewith a new type of Brake Shoe made by the Composite Brake-Shoe Company of Boston, embodying not only cork inserts, but having slots or recesses so cut across the outer tread of the shoe as to present a shearing edge, the effect being to more uniformly dress that part of the wheel tire that does not come in contact with and is worn by the rail.

The increased braking effect of cork inserts, and the more uniform dressing of the tire by this shearing edge, with corks inserted in the flange to brake and dress the flange, makes a brake shoe that will attract attention at this time when so much is being said and written on this subject.

It is also claimed that harder metal can be used in connection with the cork, giving increased mileage, and also extending the life of the brake shoe.

A discussion on air brake angle cocks was had at a recent meeting of the Western Railway club. Mr. Bronner, of the Michigan Central argued, from experience, that the ideal of a safe train pipe connection through a train is to be found where there are no angle cocks.

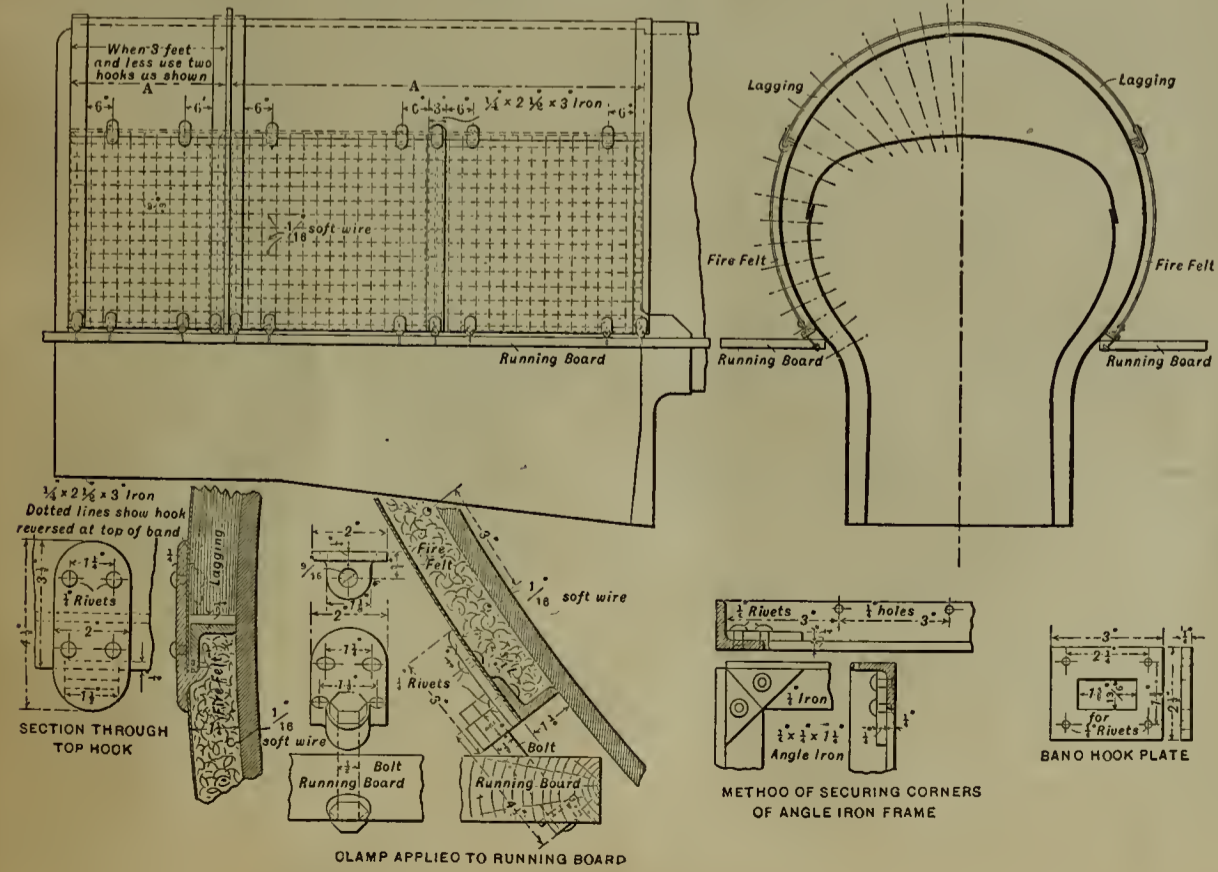
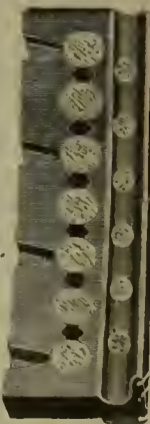

CLAMP APPLIED TO RUNNING BOARD  
REMOVABLE BOILER COVERING—N. P. RY.

tion, secured by three hooks at the top and by three clamps at the bottom of the sections. When the

gang punching. The head or guides for the plunger are unusually high, so as to support the plunger

NEW STEAM CHEST DEVICE AND LOCOMOTIVE LUBRICATOR.

The greatly increased steam pressures carried by locomotives and heavy pulls, has demonstrated the fact that the ordinary means of cylinder lubrication is meeting in many cases with a difficulty caused by excessive back pressure, the condensing of the slight current of steam sprayed through lubricator reducing nozzles, extreme pulsation and consequent

pletely full of live dry steam, as though they were attached direct to the locomotive boiler. The locomotive cylinder feeds have oil chokes only, which chokes are controlled by the valves "T" having flattened needle points at their ends to penetrate the chokes (see Fig. 3). As the automatic ball valve in the steam chest plug is thrown off its seat simultaneously with the opening of the locomotive throttle, perfect equalization is established within the whole line, the oil being fed into the cylinders at

engine man should perform is that, if the head man cannot release the brakes, he should stand ready to help him do it after a stop has been made, or after the brakes have been applied.

Mr. Kidder: (Westinghouse Air Brake Co.) I think there are instances where roads make a practice of cutting out the brakes on the head engine and still operate the brakes from that engine. The object is, in case of break-in-two, that the leading engine can get out of the way. It is a well known fact that if we have freight trains partially equipped with air brakes, and the head engine becomes detached, that engine

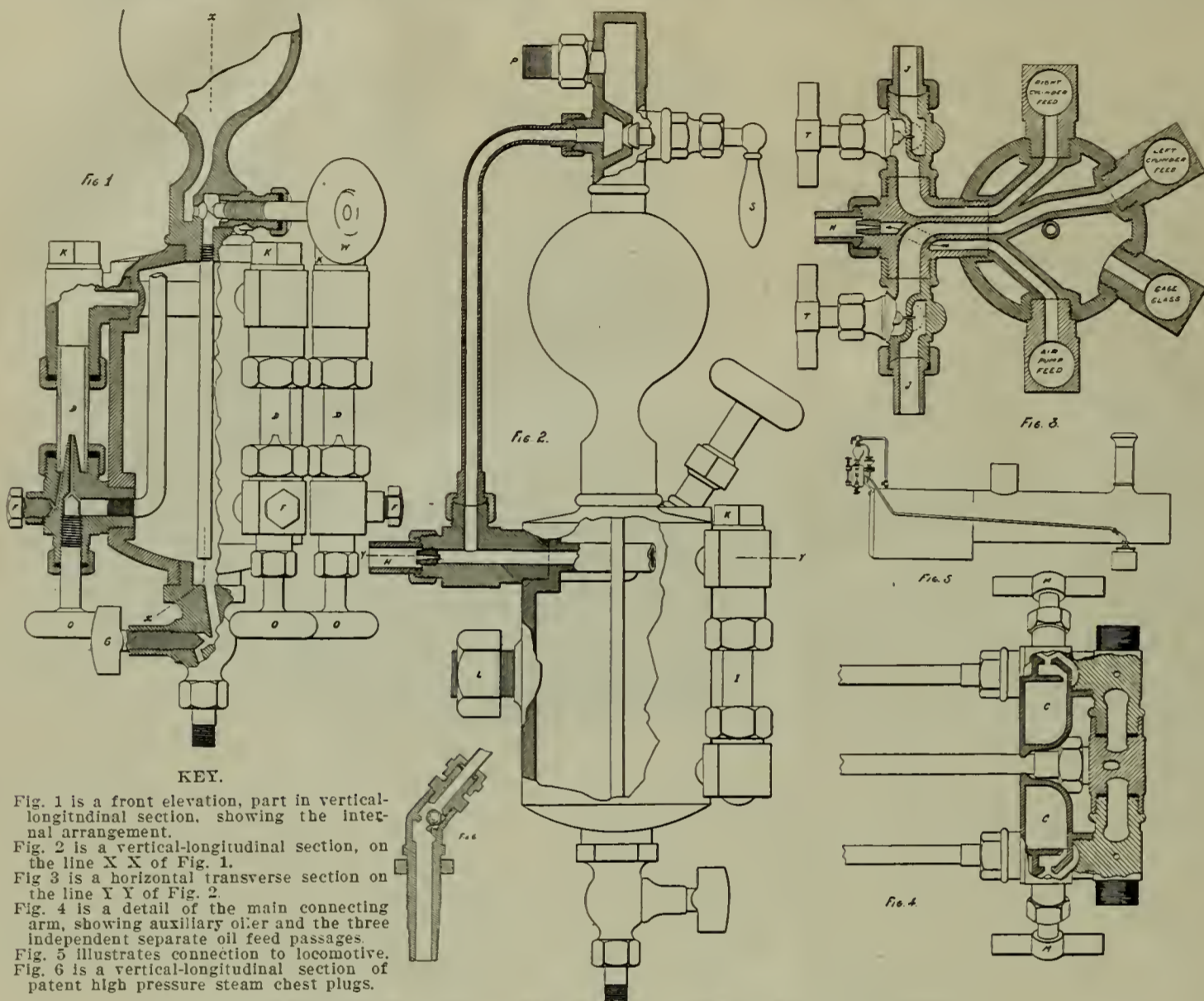

KEY.  
 Fig. 1 is a front elevation, part in vertical-longitudinal section, showing the internal arrangement.  
 Fig. 2 is a vertical-longitudinal section, on the line X X of Fig. 1.  
 Fig. 3 is a horizontal transverse section on the line Y Y of Fig. 2.  
 Fig. 4 is a detail of the main connecting arm, showing auxiliary oiler and the three independent separate oil feed passages.  
 Fig. 5 illustrates connection to locomotive.  
 Fig. 6 is a vertical-longitudinal section of patent high pressure steam chest plugs.

NEW STEAM CHEST DEVICE AND LOCOMOTIVE LUBRICATOR.

holding and churning of oil in the tallow pipe until such a time as the pressure is released on a down grade or the throttle of the engine is closed.

The drawings herewith given illustrate the Michigan Lubricator Company's improved triple lubricator and auxiliary steam chest plugs, which, under the severest tests, have proven to completely overcome the difficulty, at the same time embracing a most easy method of application, requiring a minimum change.

Fig. 1 is a front elevation of the lubricator in vertical, longitudinal section, showing the internal arrangement. Fig. 2 is a vertical, longitudinal section on the line XX of Fig. 1. Fig. 3 is a horizontal, transverse section, on the line YY of Fig. 2. Fig. 4 is a detail of the main connecting arm, showing section of auxiliary oiler and the three independent, separate oil feed passages. Fig. 5 illustrates the connection to the locomotive. Fig. 6 is a vertical, longitudinal section of the high pressure steam chest plug, having an automatic ball check of area equal to the locomotive tallow pipes, and, in addition, a steam choke close to the valve seat, the ball valve rising from its seat when the throttle of the locomotive is opened, and closing when the throttle of the locomotive is shut, bringing into play the steam choke.

The principle and operation of the lubricator proper is of the well known type, the important and chief change being that the lubricator delivers the steam taken from the boiler, by way of the condenser and equalizing pipes, direct to the tallow pipe of the locomotive on the cylinder side of the lubricator choke, thus filling the tallow pipes com-

precisely the same intervals as indicated by the sight feed glass; but the moment the throttle of the engine is closed the ball valve in the steam chest plug closes, maintaining the equalization through the steam choke in the plug.

This is claimed to be the first and only locomotive lubricator that, with only one connection to the boiler, permits a full unrestricted flow of steam direct from the boiler to the steam chests by way of the condenser. The connections are the regular form, needing no change or extra piping. Another feature much appreciated by engineers is the ability to drain and renew with water of condensation the sight feed glasses without emptying the oil reservoir, which is accomplished by closing the feed valves "O" and opening the sight feed drain valves "F". The Michigan Lubricator Company, 661 to 671 Beaubien St., Detroit, Mich., controls this interesting device.

BRAKING PRACTICE WITH "DOUBLE HEADERS"

At the February meeting of the Western Railway Club, the question of "when 'double headers' are use on passenger or freight trains, is it good practice to cut out the brakes in the forward engine?" was discussed. A brief abstract of this discussion is appended:

Mr. Manchester: (C., M. & St. P. Ry.) I should certainly say that it would be bad practice to do the braking from any other point than from the head engine. Double-headers, at least with us, are used during stormy weather, and I doubt very much if the man on the hind engine can see anything during a run of fifty miles at a time. The only part that the rear en-

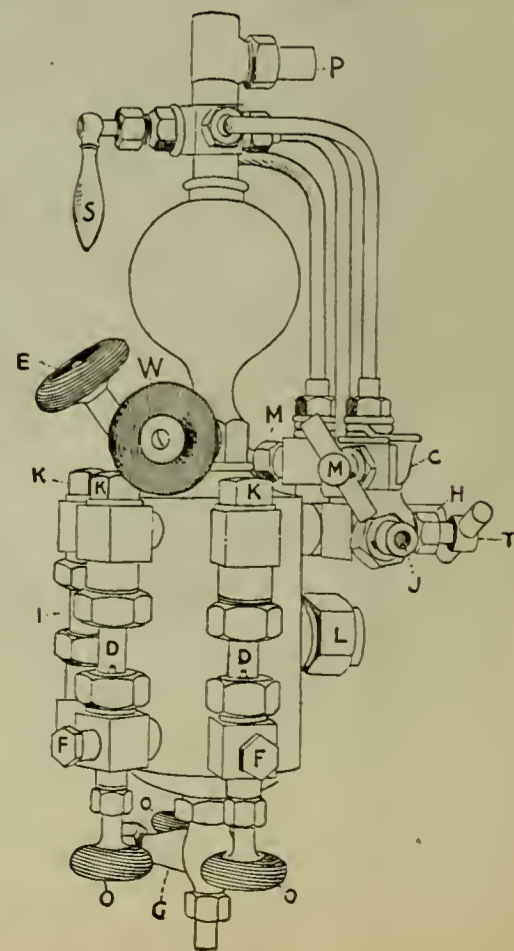

forges ahead several feet, the slack of the non-air brake cars, violently closing up, forces the second engine ahead suddenly, the brakes on the head engine in the meantime slowing up the engine, resulting in a more or less serious collision. The object of cutting out the air brakes on the head engine is to permit that engine to keep out of the way, and I think the practice has been (I know it was on some roads with which I was familiar some years ago) to cut out the brakes on the head engine for that purpose. It seems to me that the law, if it could be shown after an accident had occurred that one of these engines was running over the road with the brakes cut out, would establish a bad case for the railroad company. It is no doubt true that one of the principal troubles that exists is the fact that there is not a sufficiently secure connection between the two engines. The old-fashioned style of pencil drawbar is a very easy thing to break, and all the accidents that have come under my observation, due to engines breaking in two, were due either to the pencil breaking or one of the pins jumping out. I would urge that all brakes on the train be used, and I would also advocate that the connections between the two engines be such that this danger of breaking in two may be guarded against.

President Delano: I want to ask Mr. Kidder in reference to the point he makes about conforming with the law; considering the fact that the engine has the power of stopping by the use of the reverse lever, could this not be shown to be practically as efficient as the driver brakes. The subject is open for discussion, I believe even now, whether the driver brakes are more efficient than the proper use of the reverse lever in stopping the locomotive.

Mr. Kidder: It seems to me that if the mechanical officers of the railroad looked at it in that light, they would not go to the expense of two or three hundred dollars to apply driver brakes to the locomotives, because they must always have the reversing features of the engine. I would say that the driver and tender brakes provide a much better safety device than the reversing of the engine.

Mr. C. B. Conger (C. & W. M. R. R.): We use "double-headers" on our road very often, owing to the small size of our engines, and in all cases we insist that the men use all the brakes that can be coupled to the brake on the head engine, the head engine using the brake on the second engine and the brake on all the cars

**IRON BLOCKS VS. WOODEN BLOCKS.**

The present is correctly styled the Age of Steel; and as iron and steel ships are fast taking the place of wooden ones, so iron and steel blocks are in many cases superseding the wooden ones. Especially is this the case where wire rope is used in place of manila.

The careful observer must have noticed that wire



rope is increasingly being substituted for manila rope in many kinds of work, especially that of contractors, quarrymen, railroads, etc.

The Boston & Lockport Block Co., with factories at Boston, Mass., and Lockport, N. Y., are careful observers of the signs of the times, and are constantly making additions to their already large lines.

We illustrate herewith their new iron block for wire rope. They make these in three sizes, with sheave 10-in., 12-in. and 14-in. in diameter, respectively, and bushings plain iron, or Ford's patent self-lubricating, or genuine Metaline, which the makers consider to be the best of all.

It is being demonstrated that blocks for wire rope need to be made with greater care, and the parts more nicely adjusted than the wooden blocks; and the new block shown affords all these improvements and advantages.

**BOOK NOTES.**

**MECHANICAL DRAFT, A PRACTICAL TREATISE.** B. F. Sturtevant Company, Boston, Mass. Catalogue No. 98, 285 pages.

In the introduction of this book it is stated that the reason for proposing the work was that treatment of the question of mechanical draft in the technical press and in the engineering societies has been distinctly limited. It is explained that while mechanical draft may seem a radical departure in certain features of boiler practice, yet recent and extended experience clearly indicates the permanence of the departure and that the chimney will not hereafter be depended upon as the sole means of draft production. The first object of the work, as explained in the introduction, is to instruct by a lucid discussion of the entire subject, with such supplementary information as may be necessary to show the superiority of mechanical draft; and, second, to show the special adaptability of the Sturtevant fans for this purpose. In order to make the work complete in itself and to obviate the necessity of referring to other works, chapters on water, steam, combustion and fuels are incorporated. There are given in the chapter on heat the composition, weight and bulk, specific heat, thermal units, and pressures per foot of head, of water, together with the list of impurities usually found in water and the remedy or palliation for the same. In the chapter on steam there are given the weights of air, vapor of water and saturated mixtures of air and vapor at different temperatures, and a table of the properties of saturated steam. The chapter on combustion will be found of general interest. There is given in this chapter the composition of fuel obtained from various localities. The chapter on fuels is very complete and gives the composition of about every substance which is used to any great extent for fuel; it includes wood, straw, tropical cane and bagasse, Irish peats and coals. This chapter gives also a geographical classification of coals and a very complete table of the composition and fuel value of American coals. The composition of natural gas also receives attention in this chapter. Chapter V treats of the efficiency of fuels and after explaining the measure of efficiency, it continues with a table of factors of evaporation and a table showing the water evaporated with varying efficiency of fuel and of boiler, and paragraphs on the influence of moisture in coal, of size of coal, of air supply, of frequency of firing, as well as of the losses on account of smoke, of carbonic oxide and of excess of air, and a paragraph summarizing the influences which affect the efficiency of fuel. The following chapters, treating of efficiency of steam boilers, rate of combustion, draft, and chimney and mechanical draft, will be found of very general interest and to be relied upon, and the various tables will be found extremely convenient and useful. Chapter IX, on Mechanical Draft, is prepared in an entirely disinterested manner, and treats of steam jets and fans, the theory and design of fans being treated at such length as such a work will allow. Chapter XI puts into such form as may be quickly read and understood by those who have not the time to read the entire book, the advantages of mechanical draft. Up to the close of Chapter XI there is nothing to indicate the second object in view in preparing the book, and this part of the hook can, at least, be used as a book of standard reference. The succeeding chapters deal particularly with the Sturtevant fan for mechanical draft and while these chapters have their special object they will be found of general interest as showing the special adaptation of fans for mechanical draft. The book will serve the purposes, as outlined in the introduction, for which it was prepared and its value is enhanced by a very complete index in the back of the book.

The book as a whole will be well received, and highly valued. Its thoroughness may be indicated by the fact that it represents the accumulated experience of over a quarter of a century of the B. F. Sturtevant Company, and that Mr. W. B. Snow, of that company, has devoted nearly two years of most careful study and investigation to its preparation.

The Pioneer Scientific Society of the West, the Academy of Natural Sciences of St. Louis, is described by Prof. Frederick Starr, of the University of Chicago, in an illustrated article in Appleton's Popular Science Monthly for March.

The principle of the famous Keely motor, which the inventor has so successfully concealed for twenty years, not only from the general public but from the capitalists whom he induced to invest in his enterprise,

was recently made the subject of an investigation by a member of the Philadelphia Engineer's Club, whose technical training enabled him to make some interesting discoveries. They tend to show that the motive power is nothing more mysterious than an ingenious combination of compressed air and electricity. Mr. Scott's account of his investigations is published in Modern Machinery of Chicago for April, which also contains a halftone cut from a photograph of the latest form of the motor, which is known as the vibrodyne.

In the leading article of the April issue of the Open Court, Dr. Woods Hutchinson of Buffalo discourses upon "Courage the Chief Virtue," which is opposed by the author to the meekness and submissiveness usually taught, and contrasts the sublime fortitude of Christ to the cowardice of many interpretations of his religion. Dr. Moncure D. Conway continues his series of articles on Solomonic Literature, giving in the present number the mythological interpretation of the traditions connected with "The Wives of Solomon." The illustrated article of the number is by Dr. Paul Carus on "The Human Heart as Mirrored in Religious Art." Old woodcuts are reproduced, portraying the various conceptions of the soul as the vehicle of good and evil, while representations of modern ideas are also given.

Cassier's Magazine of Illustrated Engineering has in its April number the following articles among others: "The United States Ironclad 'Monitor.'" A new story of the historic vessel and her designer. With some illustrations reproduced for the first time from Capt. Ericsson's original drawings. By F. M. Bennett, P. A. E., U. S. N. "The Liverpool Overhead Railway and Docks." Liverpool's commercial supremacy and how it is maintained. With thirteen illustrations. By S. B. Cottrell, M. Inst. C. E. "Trade Unions and Political Economy." Teachings of the late British engineering dispute. By Francis G. Burton "Car Ferrying on American Lakes." A novel method of carrying freight, with five illustrations. By A. S. Chapman. "Inventing for a Living." Big fortunes from little inventions. By George Ethelbert Walsh. "Across the Chilkoot Pass by Wire Cable." The latest application of the Cableway. With twelve illustrations. By William Hewitt. "Suggestions for Improvement in Power Plants." The value of small economics. By A. Bement.

The first article in Appleton's Popular Science Monthly for April is an economic discussion, by S. N. D. North, of the recent engineering strike in England. The Electric Transmission of Water Power is the title of a fully illustrated article by William Baxter, Jr., describing this now widespread method of transmitting energy. The importance which the future wheat supply of the world has for civilization is pointed out by Worthington C. Ford, chief of the Bureau of Statistics at Washington, under the title The Question of Wheat. A well-illustrated article describing A Spring Visit to Nassau is contributed by Emma G. Cummings; the curious animal and vegetable population and the quaint methods of commerce still existent in this out-of-the-way corner are described and pictured. Migration is the title of a long article by W. K. Brooks, of Johns Hopkins University; he studies the subject from an evolutionary standpoint, and shows that it is simply one among the many illustrations of the general law that the adaptations of Nature are for the good of the species and not primarily for the benefit of the individual. Clemens Winkler has an article on the Discovery of New Chemical Elements, in which he gives a brief historical sketch of the rarer and more curious elements. These are but a part of the contents of a well balanced issue of this valuable magazine.

**PERSONAL.**

Mr. Richard English has resigned as general master mechanic of the Santa Fe Pacific.

Mr. S. M. Roberts has been appointed general foreman of the Plant system vice J. G. Justice, promoted.

Mr. Robert McMains, a locomotive engineer on the Iowa Central, has been appointed traveling engineer of that road.

Mr. W. R. McKeen, Jr., has resigned as general foreman of the car and locomotive department of the Terre Haute & Indianapolis.

Mr. Charles Houghton, an engineer, has been appointed traveling engineer on the Lake Shore, to succeed the late John Carter.

Mr. B. R. Brandow has been appointed master mechanic of the Leavenworth, Kansas & Western, with headquarters at Leavenworth, Kan.

Mr. F. T. Croxon has been appointed purchasing agent of the Chicago Junction Ry. Co. with headquarters at the Union stock yards, Chicago.

Mr. Frank Slater has been appointed master mechanic of the Chicago & Northwestern at Escanaba, Mich., vice Mr. J. W. Clark, resigned.

Mr. C. G. Hermar has been appointed master mechanic of the Cornwall railroad, with headquarters at Lebanon, Pa., in place of Mr. A. J. Reed.

Mr. T. A. Davis, master mechanic of the Wyoming division of the Union Pacific, has removed his headquarters from Laramie to Cheyenne, Wyo.

Mr. W. A. Stone, formerly master mechanic of the Southern railway at Selma, Ala., has been appointed

master mechanic of the Montgomery division of the Mobile & Ohio.

Mr. George W. Prescott, formerly superintendent of motive power of the Terre Haute & Indianapolis, has been appointed foreman of the shops of that road at Logansport, Ind.

Mr. E. P. Mooney has been appointed master mechanic of the Buffalo division of the Lehigh Valley, with headquarters at Buffalo, N. Y., in place of Mr. J. Campbell, resigned.

Mr. J. G. Justice has been appointed master mechanic of the Charleston & Savannah and master of machinery of the Savannah, Florida & Western, vice D. B. Overton, resigned.

Mr. G. W. Seidel has been appointed master mechanic of the Baltimore & Lehigh, with headquarters at Baltimore, Md. The office of general foreman of locomotive repairs has been abolished.

Mr. George W. Smith, division master mechanic of the Atchison, Topeka & Santa Fe at Topeka, Kan., has been appointed superintendent of machinery of the Santa Fe Pacific, with headquarters at Albuquerque, N. M.

Mr. Thomas W. Demorest, foreman of the Panhandle shops at Indianapolis, Ind., has been appointed general foreman of the Terre Haute & Indianapolis shops at Terre Haute, Ind., to succeed Mr. W. R. McKeen, Jr., resigned.

Mr. John Pickey has been appointed road foreman of engines of the Auburn & Pennsylvania and New York divisions of the Lehigh Valley, in place of Mr. A. C. Smith, who is appointed road foreman of engines of the Buffalo division.

Mr. E. T. Carleton, superintendent of car department and of interlocking of the Elgin, Joliet & Eastern Railway, has resigned. The position has been abolished, the car department being again merged with that of the master mechanic.

Mr. Frank C. Hewitt, who has long been chief clerk in the supply department of the Chicago, Burlington & Quincy Railway at Aurora, Ill., and who has been practically its head since S. L. Charles resigned, has been regularly appointed to succeed the latter as supply agent.

Mr. George G. Yeomans has been appointed purchasing agent of the Chicago, Burlington & Quincy and proprietary lines, with headquarters at Chicago, to succeed Mr. George Hargreaves, resigned. Mr. Yeomans has been assistant purchasing agent of the system for a number of years.

On the Oregon Short Line Mr. D. J. Malone, division foreman at Pocatello, Idaho, has been appointed master mechanic of the Idaho and Montana divisions of that system, and Mr. W. J. Tollerton, division foreman at Salt Lake City, Utah, has been appointed master mechanic of the Utah Division of that system, with headquarters at Salt Lake City.

Mr. F. R. F. Brown has resigned as mechanical superintendent of the Intercolonial railway, and will, it is understood, engage in private business as a consulting engineer with office at Montreal. Mr. Brown has been a leading figure among Canadian railway men and was for a long time prior to his connection with the Intercolonial, mechanical superintendent of the Canadian Pacific.

Mr. Albert M. Stimson, purchasing agent of the Big Four System, died during the past month. Mr. Stimson had been with the Big Four for nearly twenty years, in various capacities, and since 1894 had been its purchasing agent. He possessed the happy faculty of rendering the most efficient service to his employing company, and, at the same time, maintaining the most happy relations with those who sought to do business through him. His happy, jolly face and ways will be sadly missed by thousands who had come to count him among their friends.

Mr. Geo. Hargreaves has resigned as purchasing agent of the Chicago, Burlington & Quincy system and will enter private business as vice president of the Michigan-Peninsular Car Company. Mr. Hargreaves was one of the most popular purchasing agents in the entire railway service and while possessing this popularity with outsiders, he was held in the very highest esteem by the officials of his road, with which he had been connected since 1874. While Mr. Hargreaves has, it may be assumed, taken a step that is advantageous to him personally, there is yet a feeling of regret that he has left the railway service.

Very important changes among the higher officials of the Vanderbilt lines will be made during the current month. Chauncey M. Depew will retire from the presidency of the New York Central & Hudson River Railroad Company, and will become chairman of the boards of directors of the New York Central & Hudson River, the Lake Shore, the New York, Chicago & St. Louis and the Michigan Central railroads. Mr. S. R. Callaway will succeed Mr. Depew as president of the New York Central & Hudson River Railroad. Mr. Ledvard will remain president of the Michigan Central. The presidents of the Lake Shore and of the New York, Chicago & St. Louis have not yet been chosen. Cornelius Vanderbilt, in retiring from the chairmanship of the New York Central & Hudson River and of the Michigan Central and William K. Vanderbilt, in retiring from the chairmanship of the Lake Shore and of the

New York, Chicago & St. Louis, will remain in the directorates and will continue their interest in the properties.

### SUPPLY TRADE NOTES.

—The Q & C Company have accepted the western agency of the Pennsylvania Steel Company.

—Mr. C. F. Sullivan succeeds Mr. Chas. Kennedy, resigned, as agent at Chicago, of the Ewald Iron Co.

—The Detroit Graphite Company is "chuck full" of business, the volume being double that at the same period last year.

—Manning, Maxwell & Moore are furnishing Sturtevant steel pressure blowers for the blacksmith shops of the Chicago, Rock Island & Pacific.

—M. C. Hammett, Troy, N. Y., has received an order for valves from the Brooks Locomotive Works for eight locomotives for the Washington County Railroad.

—The Boston office of the Pennsylvania Steel Company has been removed to rooms 11 and 12, Mason building, 70 Kilby street, corner of Milk street. Mr. Charles S. Clark is the sales agent in charge.

—Manning, Maxwell & Moore, of New York, have received an order from the Davis-Egan Co. for a 72-inch Pond planer having a 40-foot table and four heads. This will be one of the longest planers in the country.

—Business with J. A. Fay & Egan Company, Cincinnati, O., has increased to such an extent as to justify them in voluntarily increasing the wages of their employes 10 per cent. This raise goes into effect March 21.

—The Addyston Pipe & Steel Company are turning out 275 tons of pipe per day and then find difficulty in keeping up with orders. Their business during the first quarter of the year was thrice that of the same period in 1897.

—Mr. Charles Kennedy, for the past six years with the Ewald Iron Co., has resigned to accept a position as sales agent with the Wayne Iron & Steel Works (Brown & Co.), of Pittsburg, makers of U. S. stay bolt iron.

—Mr. W. R. Anderson, for several years past general manager of the Columbus Machinery Company of Columbus, O., has resigned his position. For the present Mr. Anderson will locate in Cleveland.

—The Foos Gas Engine Company, Springfield, O., are putting in additional machinery which will greatly increase their capacity. They have been working two shifts of men for some months. They volume of business they are now handling speaks well for the engines.

—The well-known Page Woven Wire Fence Company of Adrian, Mich., are working night and day to keep up with their orders. They are about to begin a large addition to their works in the shape of a two-story fireproof building, 65x86 ft., and an office also two stories, and 60x100 ft.

—The Davis-Egan Company have purchased the old plant of the Universal Radial Drill Company in Covington, Ky., and equipped it with a full line of modern tools for the purpose of building the largest sizes of planers, lathes and radial drills. The new plant will give employment to 350 men.

—The Schenectady Locomotive Works recently received an order for twelve 16"x24" eight-wheel locomotives for the Kinshiu Railway of Japan, the engines being duplicates of a similar order completed by the Schenectady works for the Kinshiu Railway last fall. The previous installment of twelve engines is now in operation and rendering very satisfactory service.

—The United States Circuit Court of Appeals has rendered a decision in the case of the St. Louis Coupler Company against the National Malleable Castings Company, affirming the decree of Judge Taft of the United States Circuit Court, which held that the Tower coupler was not an infringement of the Lorraine and Aubin patent. Judge Taft's decision was given quite in full in our issue of May, 1897.

—The W. H. Coe Manufacturing Company, of Providence, R. I., manufacturers of gilding wheels and ribbon gold leaf, are now supplying nearly all of the leading railroads and car manufacturers in the United States and are also exporting large quantities to car manufacturers abroad. They expect to make an exhibit of their method of gilding at the next convention of master car builders to be held at Saratoga Springs, June 15th, which will be very interesting to those who have not seen this method of gilding in operation.

—Watson & Stillman are working hard to complete work which is indirectly for the government. Among recent shipments were several large forging presses for the navy department and a complete equipment of hydraulic machinery for the refurbishing of the press room of the Jewell Belting Company of Hartford, Conn. Work is being rushed on a hydraulic-pneumatic system of powder presses for the E. & C. and Shultz Smokeless Powder companies. A similar equipment is also under way for the Laffin & Rand Smokeless Powder Company.

—The January and February business of the Chicago Garin Door Company embraced grain door equipments for 500 cars for the Chicago, Milwaukee & St. Paul, 200 cars for the Mobile & Ohio, 250 cars for the Chi-

cago, Rock Island & Pacific, 200 cars for the Illinois Central, 125 cars for the Great Northern, 25 cars for the Sioux City & Northern, 60 cars for the Intercolonial Railway of Canada, and 600 cars for the Canadian Pacific, in addition to safety brackets for 100 cars for the Denver & Rio Grande and 700 cars for the Illinois Central.

—The Schenectady Locomotive Works recently received orders for 20 locomotives for the Chicago & Northwestern Railway, 10 duplicates of 10-18"x24" six-wheel switching and 10 19"x26" ten-wheel freight, duplicates of engines of the same class recently constructed by the Schenectady Locomotive Works for the Chicago & Northwestern Railway. The works also recently received orders for 10, 19"x24" ten-wheel freight and one 19"x24" passenger locomotive for the Chicago, St. Paul, Minneapolis & Omaha Railway.

—The Baldwin Locomotive Works of Philadelphia, Pa., have recently delivered to the Baltimore & Ohio Rail Road Company the last of the largest order of locomotives placed last fall. This delivery included twenty heavy engines which are now being broken in for service between Cumberland and Baltimore. These locomotives are of the same style that the motive power department adopted as the standard for the first and second divisions. They are of the Consolidation type with 21"x26" cylinders and the average load that they pull approximates 1,800 tons.

—Mr. Geo. Place, of 120 Broadway, New York, has just completed the appraisal of the assets of the Herring-Hall Safe Company made at the request of parties interested in the re-organization of that company. The value of the assets was about \$1,500,000 and the items covered by the appraisal filled more 52 sheets of foolscap. A few months ago Mr. Place appraised the assets of the American Ordnance Company, of Bridgeport, Conn., which amounted to about \$600,000. In both these cases Mr. Place acted alone and his valuations were accepted as final.

—The Franklin Steel Casting Company, Franklin, Pa., manufacturers of open hearth steel castings weighing up to 60,000 pounds, have a contract aggregating 1,000,000 pounds of steel for the London Underground Electric Railway, and are just finishing the generators for the Metropolitan Railway Power House in New York City, of which there are eight to be installed, weighing over 500,000 pounds. In addition this firm are engaged in filling contracts for over 800 sets of motor frames of various types. Their coupler department is full of business, and a contract has just been closed with a leading railroad system for 10,000 sets to be shipped during 1898.

—The heavy business so far this year, showing in fact an increase of something like 40 per cent over business for corresponding period in 1897, has made it imperative for the Sargent Company to considerably increase their capacity, and to that end they have recently installed a large twenty-ton electric traveling crane from Manning, Maxwell & Moore, in addition to the cranes now operated, and an additional saw of the latest and most improved type manufactured by the O & C Company. The company have also rearranged their receiving and shipping departments extensively. In the power house, new engines, dynamos, etc. are about to be installed. They now have a capacity of about 1,000 tons a month which will, of course, be greatly increased by the changes now in progress.

—It is the slipping heel that wears the hole in the stocking, and it is the slipping belt that wears the leather. Belts that slip not only do not drive properly, but they wear out rapidly. A belt that is too tight is over-strained, and will also wear out rapidly. A thoroughly reliable belt dressing is therefore a necessity in every well regulated factory, and probably no dressing has such a world-wide reputation as Dixon's belt dressing and leather preservation. As long ago as 1878 it was used on the big driving belt at the Paris Exposition, when every other means had failed to make the belt take hold of the pulley that was to start the thousands of feet of shafting and hundreds of machines. Those who use Dixon's belt dressing claim that it prevents slipping and thoroughly preserves the life and elasticity of the belt. It is made only by the Joseph Dixon Crucible Company, Jersey City, N. J.

—Messrs. Burden, Renshaw & Co., of Troy, N. Y., controlling the Trojan Car Coupler Co. have acquired a controlling interest in the Standard Railroad Signal Co., of Arlington, N. J. A. H. Renshaw, H. Burden, 2nd, P. C. Ricketts, H. Johnson and J. T. Cade now constitute the board of directors of this company. The officers are A. H. Renshaw, president; H. Johnson, vice president and treasurer; J. T. Cade, secretary and general manager. The executive officers of the Trojan Car Coupler Co. will unite their efforts to those of the signal company to make this business as great a success as has been made of the "Trojan coupler." The infusion of a large amount of new capital will also enable the signal company to meet all competition. The New York office of the Standard Railroad Signal Co. in the Havenmeyer Building, will be moved to that of the Trojan Car Coupler Co. at 49 Wall street, on or about April 1 next. The Chicago office of the former company will not be changed for the present. The Standard Railroad Signal Co. have recently secured a large amount of new business both in the east and in the west.

# RAILWAY MASTER MECHANIC

WALTER D. CROSMAN, Editor.

EDWIN N. LEWIS, Manager.

PUBLISHED MONTHLY BY

THE RAILWAY LIST COMPANY.

Devoted to the interests of railway motive power, car equipment, shops, machinery and supplies. Communications on any topics suitable to these columns are solicited.

Subscription price, \$1.00 a year, to foreign countries \$1.50 free of postage. Advertising rates given on application to the office, by mail or in person. Address

THE RAILWAY LIST COMPANY,  
The Rookery, Chicago, Ill.

The Official Railway List is published by this company.

VOL. XXI. CHICAGO, MAY, 1898. No. 5.

MANY railway officials have kept file of the Official Railway List ever since they began to receive it. A bound copy of the June or July List (or of any other month, in fact) will be the same in all respects as the annual edition and we will bind and send to any address a bound copy of the latest number on receipt of fifty cents. This price merely covers the actual cost of binding and mailing.

THE wisdom of the Master Mechanics' Association in devoting its surplus funds, some years ago, to the purchase of technical scholarships for sons of members has been amply proven. It was indeed a happy thought that led to this disposition of the fund. We understand that there will be one vacant scholarship at Stevens Institute this year, for which the sons of members of the association may compete. Those of the members who were given opportunity, through the Western Railway Club's excursion to Purdue, last month, to see what a technical school may mean to a bright boy, are feeling more than ever pleased over the diversion of the association funds to the purchase of scholarships.

WHEN one views some of the recent examples of the application of M. C. B. couplers to the pilot end of the locomotive he is apt to ask himself: "Of what use is the pilot now?" Indeed, the impression is given to one, almost, that the next step may be an abolition of the pilot altogether, and an adoption of English and continental practice where the coupler and buffers alone are interposed at the head of the engine. We noted a particularly bad example of this kind of work recently, where the pilot was so completely mantled with the massive supporting frame work of the coupler that it would seem almost impossible for it to perform its supposed occasional function of throwing up or away any obstacle, living or inanimate. When that particular engine strikes anything there will be little chance of a glancing blow—it will be a case of a good, hard "smash." Is it possible that those who have been working for smaller and smaller headlights, until they are becoming little more than signal lights, and who belittle their value even as such—is it possible that these people are now quietly seeking to also down the pilot?

THE use of electricity for shop power is increasing, but its introduction has been materially held back by reason of the natural unfamiliarity of mechanical men with its possibilities and with its limitations. Air, on the other hand, has made wonderful strides through the shops, not altogether because of its many advantages, but somewhat because of the fact that it was a familiar agent, well known through air-brake work and already at hand through plant and piping designed for yard testing of brake apparatus. A greater measure of acquaintance with the leading considerations surrounding the use of the electric current for power transmission in shops is now afforded by Mr. Geo. Gibbs' paper, which we give elsewhere in this issue. The general lack of practical information on this topic which

prevails, and which has operated to restrict the employment of the electric current in shops, is our excuse for giving so much space to the paper under notice. On electricity as applied to railway work Mr. Gibbs is probably our best authority today; and in his present treatment of some of its phases he is not only intensely practical, but he writes to the level of those who having no higher knowledge of the theoretical problems involved, want to know how they can best bring the subtle fluid to their service in the shop.

OUR article on the M. C. B. coupler, in the April issue, has occasioned considerable comment. Of the many letters and verbal comments that have come to us we are permitted to use the expression of view of two, and these will be found elsewhere in this issue. They are suggestive in differing ways and may be read with profit. It will not do now to attempt to definitely prescribe the proper remedy for the evils of the present coupler situation. There is too wide a diversity of view by practical men. Indeed, while some are earnestly thinking about the best way to increase the strength of couplers by increasing their dimensions, there are those who believe in using smaller dimensions, relying upon better material to give the required strength. It is, too, urged that the coupler should be made lighter and that it be at the same time relieved of its load by improved draft rigging and, more particularly, by the use of buffer blocks with which to absorb the final strains through the end sills. Meanwhile it will be the part of wisdom for the railways to put on nothing but the best in the way of coupler material, for, with owners responsible for breakage, as they now are, a cheap meeting of the safety appliance law will prove costly in the end.

### JOURNAL BEARING METALS.

The problem of reducing delays to traffic due to hot boxes is an old story. On the proper solution of this problem with its corollaries relating to journal bearing metal and lubrication, opinions differ widely. Especially do they differ regarding the respective merits of filled and solid bearings. Each form of bearing has its eminent advocates among thoughtful, conservative railway men. Those who favor the solid bearing are undoubtedly in the majority. We wish to consider, however, without discussing the relative merits of filled and solid bearings, the best means of obtaining a solid bearing to give maximum satisfactory service at a minimum cost.

Railroad companies have agreed with each other not to sell to junk dealers car bearings inscribed with the initials, or insignia, of a railroad company; the object of this arrangement being to put a handicap on the theft and subsequent traffic in this material. As a result large quantities of scrap bearing brass accumulate for which some disposition must be devised.

Experience has repeatedly proven that by using proper care and suitable methods a satisfactory bearing metal can be produced of practically all scrap material. There is, of course, no doubt but that bearing bronze composed entirely of new metal will be more uniform in composition and possess better bearing qualities than can be obtained from scrap material, but it is questionable if the superiority would warrant the 25 per cent or 30 per cent higher cost of the new material.

As a bearing metal which has met with considerable favor phosphor bronze may be mentioned. Phosphor bronze, more or less closely approximating the following composition, has come into extended use:

Copper .....	79%
Lead .....	10%
Tin .....	10%
Phosphorus .....	1%

this alloy being primarily an 8 to 1 bronze to which lead has been added to improve its bearing qualities, and phosphorus, a strong reducing agent, to reduce such oxides of copper as may be present and thus render the metal close grained and homogeneous.

Assuming that in making a bearing metal from scrap we are aiming at approximately this composition, the materials used should be selected with this end in view. It is manifestly absurd to charge all sorts of disreputable scrap into a crucible and ex-

pect to pour out high grade phosphor bronze. The ordinary run of scrap available for use in car bearings is found to contain zinc, and generally an insufficient proportion of tin. The presence of zinc in moderate quantities is not necessarily a serious detriment, as more or less zinc is vaporized off in the melting. If tin is lacking its deficiency should not go unfilled. Enough tin should be added to form a proper alloy, and give the metal fluidity. Of course tin is a high priced metal, but its moderate use is often necessary to obtain proper results.

As is well illustrated under the microscope, lead does not chemically alloy with the bronze, but is held in the mixture mechanically, very much as water is held in a sponge. As much lead should be added as the alloy will hold up. This is desirable for a two-fold purpose,—lead improves the bearing qualities of the alloy and at the same time cheapens its cost per pound.

One of the most troublesome conditions encountered in the production of bronze bearing metals is the great affinity which oxygen has for copper and its alloys in the molten state. If care is not exercised in excluding oxygen from metal, the resulting bearing, on being fractured, will show discolored oxide spots, which in a car bearing, are fatal to cool running. The oxide being harder than the unoxidized portion of the bearing is pretty certain to give trouble in service, for the hard spot if occurring in the bearing surface, is almost certain to form the nucleus for a "copper spot" and be the cause of a hot bearing.

Investigation of the cause and cure of "copper spots" has received much attention from people interested in bearing metals and from those whose chief concern is lubrication. If a bearing has run hot in service and is removed, almost invariably a portion of the bearing surface will appear covered with a thin film or skin, resembling copper. These spots have sometimes been termed "copper spots," and the theories evolved to account for the existence of these spots have been numerous and ingenious. The most simple theory appears the most reasonable, and seems to be fully confirmed by experiment. The theory is that if a bearing be ever so good, and perfectly fitting an absolutely smooth journal, if the bearing be run without lubrication, abrasion will take place, the detached particles of the bearing metal will be carried around by the journal and deposited in spots on the surface of the bearing. These spots gradually increase in thickness so that the entire weight of the bearing is borne on this film-covered area. The result is that the pressure per unit area is excessive, the heating is accelerated, and this goes on until some means are taken to abate it.

In corroboration of this theory, laboratory tests have shown that, when a first-class bearing was fitted perfectly to the journal of an oil tester, load applied and run made, exactly these phenomena were observed, and the metallic film on analysis was found to be of exactly the same composition as the bearing metal.

In the matter of keeping bearing metal free from oxides of copper much good may be accomplished by preventing oxygen from entering the material in the first place. For example, a shovelful of brass turnings presents a vast area for oxidation. If these turnings are badly tarnished and mixed with dirt and dumped direct into a charge of bearing metal a large amount of oxygen goes into the metal. Suppose a crucible full of these turnings be melted by themselves and poured into ingots, if during the melting a liberal supply of charcoal be used, a certain amount of the oxides will be reduced and the ingots on being broken will show a reasonable freedom from oxides. The ingots may then become part of a charge for car bearings. By using turnings in this manner they become a benefit instead of a detriment to a bearing metal.

Three means may be employed to avoid the presence of oxides in bearing metal: 1st, by preventing badly oxidized and improper materials from entering the mixture; 2nd, by protecting the molten metal from the oxygen of the air by a coating of charcoal or other suitable material; 3rd, by reducing such oxides as are unavoidably present by means of phosphorus or other reducing agent.

Neglect of simple precautions in preparation of bearing metals may lead to very unsatisfactory results and there is little doubt that to obtain a satisfactory bearing metal both methods and materials must be the objects of careful scrutiny.

**AN IMPORTANT PATENT DECISION.**

The supreme court of the United States rendered a very important decision, March 21, 1898, involving the authority of a primary examiner of the patent office to reject as invalid claims of an original patent which were incorporated in an application for a reissue. This was due to the United States circuit court of appeals having certified to the supreme court the following question:

"If the owner of a patent applies to the patent office for a reissue of it, and includes among the claims in the application the same claims as those which were included in the old patent, and the primary examiner rejects some of such claims for want of patentable novelty, by reference to prior patents, and allows others, both old and new, does the owner of the patent, by taking no appeal and by abandoning his application for reissue, hold the original patent, the return of which he procures from the patent office, invalidated as to those claims which were disallowed for want of patentable novelty by the primary examiner in the proceeding for reissue?"

This, the supreme court answers in the negative. It will be seen that the validity of the claims referred to depended upon the view taken of the action of the examiner in rejecting them when incorporated in an application for a reissue of the patent, upon the ground that the claims were wanting in patentable novelty, as evidenced by prior patents cited by him. But the supreme court holds that, upon the issue of the original patent, the patent office had no power to revoke, cancel, or annul it. It had lost jurisdiction over it, and did not regain such jurisdiction by the application for a reissue. Upon application being made for such reissue the patent office was authorized to deal with all its claims, the originals as well as those inserted first in the application, and might declare them to be invalid, but such action would not affect the claims of the original patent, which remained in full force, if the application for a reissue were rejected or abandoned. The title of the case in which this decision was rendered is McCormick Harvesting Machine Company against C. Aultman & Company.

**DOES IT PAY TO EXHIBIT AT THE JUNE CONVENTIONS?**

The "exhibit" feature of the June master car builder's and master mechanic's conventions has gradually grown to large importance and requires annually the time and services of a considerable number of men and the expenditure, in the aggregate, of a large amount of money. Whether these exhibits pay those who make them is a question which is being asked with increasing frequency and earnestness.

As a general proposition it may be positively averred that some exhibits do pay. The exhibitor who can show something new, useful and available may be certain that his exhibit will be abundantly noticed and that its display at the conventions will help him considerably along the road of financial success. It is a mistake not to show such things at the conventions. But before the inventor or promoter decides to make an exhibit at Saratoga or Old Point Comfort let him be fully assured that his invention is not only new—not only an improvement on existing devices—but also that it is available, that is, that its adoption and use do not require some radical change in existing practice. This is a point too often forgotten or made little of. There is an old story of a pair of andirons which cost the man who bought them \$10,000, because he had to replace fireplace, carpet and furniture, and finally build a new house in order to have everything correspond to the fine andirons. There are many ingenious inventions shown, which are really improvements on present practice, but the adoption of which would require changes the final cost of which would be enormous and impossible. The man who can show an improvement whose adoption does not require any change in existing standards except the one which it is designed to replace has the best chance of quick success. There have been shown for instance at past conventions, roller bearings for car axles, which, unquestionably, would be successful if adopted. But their adoption necessitated an entirely new journal box—new methods of inspecting and oiling, and other new constructions and practices, and because of all these necessary new things the inventions were not available.

From one point of view the exhibition of ingenious but impossible inventions at the conventions might be encouraged; they certainly add to the interest and enjoyment of the occasions. Some ex-

hibits in the past have added much to the gaiety of the occasion and helped to ward off gloom and dyspepsia. But when one remembers that these "crank" exhibitors, as they are usually called, are always poor men whose expenses at the conventions are provided for only by much self denial and even suffering, even the most thoughtless joker would advise them to stay at home.

It pays, sometimes, to make an exhibit of a new device in order to determine whether or not it is worth putting money into and placing on the market. By listening to the remarks which railroad men make concerning it, rather than by asking them direct questions, one may get full information on which to base his decision.

For those who sell ordinary, staple supplies or whose devices have been long in the market and are well known to railroad men generally—exhibits at the June conventions are a useless expense. It is true that such established concerns can usually stand the expense without feeling it particularly, but that fact does not justify them.

Complaint is made by some of the exhibitors at every convention that the railroad men will not look at their exhibits. The complaint is not well founded. Almost without exception the officials who attend the conventions examine every exhibit that has new and interesting features. Some of them do this very quietly—even getting up very early in the morning to do it before the exhibitor is out of bed. They wish to examine things quietly, undisturbed even by the explanations of the man in charge. Some exhibitors are too anxious and earnest—they have what is equivalent to an attack of buck ague when some prominent official stops to see what they have to show. They are too intense—or they resent criticism with temper. Other exhibitors rebel by their efforts to secure orders or promises for orders—but these are usually very new to the business. The exhibit annex of a June convention is the place of all others where the exhibitor should not try to secure orders for his device. In the exhibit room the railway officer is a guest and should be treated as such. No courteous man tries to sell things to his guests.

The conclusion is: if you have something new and worth showing then by all means exhibit it at the convention. It is the best, the most effective, advertising possible. Who of those at Congress Hall two years ago have forgotten the impression made by the cast steel locomotive frames exhibited with parts pulled and strained and twisted to show the strength of the metal? These exhibits gave information which the members wanted and were glad to get. The same was true of the exhibits of pneumatic tools—then comparatively new. But unless your exhibit shows what is new and has genuine merit leave it at home.

**SOME RECENT SUGGESTIVE LEGAL DECISIONS.**

The respective responsibilities, in the eyes of the law, of the master and the servant, in railway circles, have often been adjudicated in the courts of the land. But new conditions and new views constantly come up. Some recent decisions, which are of especial interest to the mechanical department, have engaged our notice and we give a brief review of three of them as follows:

**STATION AGENT CAN ASSUME BRAKES ARE ALL RIGHT.**

A station agent whose duty it was to set the brakes on cars left by passing trains on the side tracks at that station to prevent the wind blowing the cars off the side track onto the main line, was precipitated from a car and injured late one evening by the breaking of a wire connecting the brake chain with the brake rod. This brings out a decision of the Supreme Court of Nebraska, *C. B. & Q. R. Co. v. Kellogg*, March, 1898, that, since it was not the duty of the station agent to inspect this brake, nor to repair it if he found it defective, and since he did not know that the brake was out of order, he had the right to presume that it was in proper condition and reasonably fit for the purposes for which it was intended; and that the general allegation that the railroad company had been guilty of negligence in permitting the brake to become and remain out of repair, coupled with other allegations of the station agent's duty, and his want of knowledge of the defective condition of the brake, rendered his petition for damages invulnerable to demurrer. As the governing rule of law, the Supreme Court states that it is the duty of a master to furnish the servant tools and appliances rea-

sonably safe and fit for the purposes for which they are designed; and if the master neglects to do this, and the servant is injured without fault on his part, the defect in the instrument or appliance not being obvious, the master is liable. Nor does the court consider that the station agent had any reason to charge the railroad company with knowledge of the defective condition of the brake, or that it had been out of repair for such a length of time that the company, by the exercise of ordinary care, could have discovered its condition. The company was required to make its defenses, if it had any of this character to be interposed. Furthermore, it holds that the company was liable if the injury resulted from neglect of duty on the part of a car inspector.

**WHY REASONABLENESS OF RULES IS MADE A QUESTION OF LAW.**

When a railroad company has deliberately adopted a system of rules, which have been made familiar to its employes, and its railroad is operated under them, the United States circuit court of appeals holds, in *Little Rock & Memphis Railroad Company against Barry*, that the reasonableness and sufficiency of these rules are questions of law, and not of fact. Continuing, it says that these questions must be determined by the court, that is, by the judge, instead of by the jury, because there is no other way in which a set of rules may ever be established or adjudicated as either reasonable or sufficient. It may be said that the trial judges often differ upon questions of this character. But the answer to this objection is that the appellate court will finally settle them, and in the end a substantial uniformity of decision as to the reasonableness and sufficiency of any set of rules in general use must eventually result, if these questions are left to the determination of the courts (or judges). If, on the other hand, they are remitted to the juries, the court of appeals points out, their various findings can result in little less than confusion worse confounded. The decision of an appellate court becomes a precedent for the rulings of many inferior courts. But the finding of one jury is no precedent for the decision of another, and a rule that is found to be reasonable by one jury will frequently be thought to be unreasonable by another; and no criterion will ever be established by which railroad companies may measure their duties in this regard, if the reasonableness and sufficiency of their rules are to be daily submitted to new tribunals, which are governed by no precedent, and are without experience in the determination of these questions.

**ENGINEERS BOUND TO DISCOVER PATENT DEFECTS BEFORE STARTING.**

The appeal case of *Fordyce against Edwards* was, in March, before the supreme court of Arkansas for a second time. It was brought to recover damages for personal injuries sustained by the derailment of an engine, caused by striking a cow, but which injury was alleged to have been due to the negligence of the receivers of the *St. Louis, Arkansas & Texas Railway Company* in furnishing the plaintiff with a locomotive the pilot of which was raised so high above the track that the locomotive was dangerous to operate. This was held, when the case was before the supreme court the first time, to be a patent defect, to observe which, the plaintiff, the engineer, was required by law to use ordinary care. It is, of course, well settled, now reaffirms the court, that a plaintiff in the situation this one was bound to use ordinary care to observe patent defects in machinery he is operating; and if he fails to do so, and is injured by an accident resulting from such defects, he cannot recover damages for his injury, for he assumes the risk. An instruction, given the jury, that if this engineer, during the course of his trip, discovered that, owing to the use of an improper spring under the locomotive, the same had become dangerous, then, by remaining in the performance of his duties, he did not assume the increased risk occasioned by such defect, unless the increased risk was believed to be so hazardous that a reasonably prudent man would not have continued in the performance of his duties, the supreme court pronounces erroneous, in that it left out of consideration the question whether the engineer had used ordinary care to discover the defect complained of before starting on his trip. The defect was a patent one, and the court holds that the engineer, under ordinary circumstances, ought to have discovered it before starting on his trip; and, if he did not, he assumed the risk incident to the operation of the engine in that condition, and the fact that he discovered it afterwards would not alter the case.



NOTES OF THE MONTH.

It is announced that the always interesting subject of locomotive water supply will probably be made the subject of a paper before the coming meeting of the Western Society of Engineers, to be presented by Mr. T. W. Snow. This very important topic could, possibly, find no better expositor than Mr. Snow, and the paper will be awaited with interest.

\* \* \* \* \*

Electrical, pneumatic and mechanical power transmissions in manufacturing establishments were discussed topically at the meeting of the Western Society of Engineers held in Chicago April 20. Prof. D. C. Jackson, of the Engineering department of the Wisconsin University, opened the discussion by referring to the general availability, convenience and economy of electricity for power purposes. Mr. Eugene B. Clark, electrical engineer of the Illinois Steel Co., discussed in a very able manner the use and desirability of electric power in rolling mills, and cited the following uses to which it is applied in the Illinois Steel Company's Plant. 1—Lighting—both arc and incandescent; 2—Series motor operations—as motors on traveling cranes, electric hoists and conveyors, charging and drawing machines, table rolls, transfer cars, etc.; 3—Shunt motors—operated intermittently—driving lathes, sheers, pumps, crushers, drills, etc.; 4—Shunt motors—operated continually; 5—Incidental uses. Additional discussion upon the electrical division was had from Messrs. Brinkerhoff and Coster. The pneumatic section was then introduced, and handled with clearness by Mr. James F. Lewis of the Rand Drill Co. Facts and figures were arrayed so as to show the efficiency of this power in the operations in every field. It was claimed that very few situations could be cited where compressed air could not be used advantageously. Numerous letters from railroad men were read emphasizing the efficiency and economy of using compressed air in connection with railroad work shops. The transfer of mail matter by the use of compressed air in Boston, New York and Philadelphia was also commented upon. Mr. C. W. Melcher, of the Ingersoll-Sergeant Drill Co., next presented an excellent paper, adding further testimony to the strong hold compressed air is securing in the transmission of power. Mr. H. J. Westover, of Sargent & Lundy, taking up the mechanical question gave a number of figures of practical tests of the transmission of power direct to machines through several belts, etc. Mr. Robert Ardell, of the Link Belt Machinery Co., presented the American features of Manila Rope Transmission. Mr. Thos. T. Johnston, Ass't Chief Engineer of the Chicago Drainage Canal, suggested in a brief way the transmission of power by water—the advance recently made in the design and manufacture of water motors. We wish to here state that an extended paper on the electric transmission of power, by Mr. Geo. Gibbs, presented before the New York Railroad Club, is given quite in full in another column of this issue.

\* \* \* \* \*

The important part that natural gas has played in the industrial development of certain sections of our country is too well known to need review at this time. It has long been felt, however, that this invaluable gift of nature has been grossly wasted, and it is a welcome fact that a legal check to this waste has just been interposed. Cassier's Magazine for May relates the circumstances as follows: "One of the most interesting legal decisions that has latterly been made in the United States is that arrived at not long ago by the Supreme Court of Indiana, and which was unanimous that the plea for an injunction restraining the oil companies from wasting natural gas should be granted. The suit was brought by the Attorney-General of Indiana to punish those who were violating the laws of that State forbidding the waste of natural gas. A local court had previously decided that this waste was legal on the ground that a man had a right to do what he chose with his own, but the Supreme Court reversed this decision and declared such waste illegal on the ground of the general public good." In comment on this development Cassier's says: "The court's decision is very popular in Indiana, as by stopping the waste of natural gas it is believed that the supply will be prolonged indefinitely and the industrial interests of the State will be served a most excellent turn. Certainly no one who is not familiar, through personal observation, with what

has, for a long time, been going on in some of the natural gas districts of the United States, can have any conception of the reckless waste of the gas that has been, and is probably still being, practised. Not only have grossly inefficient forms of business been used, but in many places there have been no burners at all and the gas has been burned simply from open ends of pipes, with no attempt at an admixture for proper combustion. Gas jets and fires, moreover, have been left burning at all times, day and night, simply to save matches and to avoid the trouble of relighting. Early exhaustion of the gas wells was to be expected under such conditions. Many of them have, in fact, given signs of distress, and the action that was taken in Indiana seems to have come almost in the nick of time."

\* \* \* \* \*

The gun shop of the immense works of the Niles Tool works, at Hamilton, Ohio., is just now of special interest. The company is building a number of ten inch mortars for the government. The main tubes and jackets are received from the Bethlehem Iron Works, and the re-inforcing jackets are shrunk on at Hamilton. The accuracy required in finishing the bore and in constructing the breech mechanism is such that a plus or minus excess of over one thousandth of an inch causes the work to be rejected, and even variations up to these limits must not be too frequent. Fully 5000 final measurements are made by the government inspector on each mortar and each of these measurements is forwarded to and recorded in Washington. The company is also building the carriage mechanism for disappearing guns of ten inch caliber. The tremendous recoil of these guns when fired is utilized by very simple mechanism to lower the gun automatically to a position of safety in a pit or behind a protection earthwork. It is aimed as well as loaded while lowered, and is lifted and exposed only during the instant of firing. This method requires extreme accuracy in machinery and movement. For carriages built at Hamilton the variation in the position of the gun when it rises to the firing position are restricted to less than one one-hundredth of an inch. To confine the effects of the momentum of such an immense weight within limits so narrow is a genuine triumph of mechanical skill.

\* \* \* \* \*

The proper lubrication of gas engine cylinders has been a very difficult problem, one, however, that seems to have been solved by an official of the Pennsylvania Railroad Co., who writes as follows: "I had a gas engine at Sharon, Pa., running a pump, and the man that had charge of it allowed the lubricator to run dry and cut the piston, piston rings and cylinder. The makers of the gas engine said the cylinder would have to be sent to the shop and bored out and a new piston put in. It was our busy season and we could not do without water. I had some of Dixon's finely pulverized graphite, and I commenced to feed it into the cylinder through the suction pipe with the air and gas with immediate relief. After about two weeks the engine was running smoother and using less gas than ever before. I had this same engine apart last Saturday, and every place that was cut is smooth as glass. This one instance saved us about \$75.00."

\* \* \* \* \*

Although the courts in some of the states have permitted incompetency of employes to be shown by general reputation, the court of appeals of New York takes the stand, in Park against the New York Central & Hudson River Railroad Company, March, 1898, that the safer and better rule is to require incompetency to be shown by the specific acts of the employe, and then that the employer knew or ought to have known of such incompetency. The latter, it says, may be shown by evidence tending to establish that such incompetency was generally known in the community.

\* \* \* \* \*

Purdue University has a new building in the process of erection which will constitute an addition to the present Engineering Laboratory. The new portion is 50x100 feet in size, is located between the Steam Engineering Laboratory and the Locomotive Laboratory, and is to be connected by passage ways with both of these buildings. The addition is to be known as the railway laboratory and is the last of the series of engineering laboratories which were provided for in the original plan of the present group. The Purdue Engineering Laboratory, which is second to none in the world, now in-

cludes seven large laboratory rooms, each presenting an area of floor space of about 5000 square feet. They are: A wood-working room, foundry, forge-room, machine room, steam engineering laboratory, locomotive laboratory, and railway laboratory. The last named is to be occupied by apparatus for testing the strength of materials and by the brake-shoe testing machine of the American Master Car Builders' Association which is soon to be deposited at Purdue. It is expected, also, that a considerable amount of other apparatus for engineering research along lines which are of especial interest to car builders and to superintendents of motive power will be given a place in this building.

\* \* \* \* \*

A novel feature in railway club work was introduced at the last meeting of the St. Louis Railway Club, when the paper of the day was presented through the graphophone. The St. Louis Club has a decided penchant for novelties and has followed it ever since, in the first year of its existence, it performed the novel feat of building up a membership that almost equaled in numbers the membership of the largest club in the country. There is an element of true southern dash about this club that keeps it constantly well in view.

\* \* \* \* \*

The Chicago Great Western is preparing a fine train for its Chicago-St. Paul run. It will be placed in service about July 1 and will comprise sleepers and buffet cars from the Pullman works and chair cars from Barney & Smith. The buffet cars are to be entirely different in design and interior finish from any of the buffet cars now in operation, and are expected to be without peer in genuine attractiveness.

\* \* \* \* \*

Information concerning the scholarships of the Master Mechanics' Association comes from Secretary Cloud. It appears that there will be one vacancy in the Association scholarships at the Stevens Institute of Technology, Hoboken, N. J., at the close of the present college year in June. Acceptable candidates for this scholarship at the June examination are sons of members or of deceased members of the association. Any such who desire to attend the June examination should apply to the secretary, and, if found eligible, he will give certificate to that effect for presentation to the authorities, which will entitle the candidate to attend this examination beginning at the Institute on June 3, 1898. When it is desired, the school authorities will arrange for the examination of an applicant at any of the large cities of the country, but in that case the applicant must pay the Institute a fee of \$10 to cover the additional cost of conducting the examination at such point. The successful candidate will be required to take a course of mechanical engineering. If the vacant scholarship is not filled by the June examination an additional circular will be issued prior to the fall examination giving full information as to acceptable candidates for that examination.

\* \* \* \* \*

The visit to Purdue University made by the Western Railway Club April 19 in place of its regular meeting was an unqualified success. The special train provided by the Monon management was made up of modern cars, and there were enough of them to accommodate the 200 members that made up the party. The train made its runs on time and the club had about five hours in Lafayette. The compact, clean and busy shops of the Chicago, Indianapolis & Louisville road were an instructive object lesson, and many details of their equipment and arrangement were noteworthy. The members of the club will not soon forget what they saw in the various departments of Purdue University. Every one of them went away from the grounds pleased and proud that here in the middle west such an institution for technical training has been established. To see it all made the old men wish that they were young so that they might take advantage of such provision for beginning active and responsible life. The young generation ought to go further and higher than their fathers because of the far better start they have. The sight of those 600 or 700 young men all busily at work in the various departments was an inspiring one. They all were, or looked as if they were, of more than average intelligence, and were all intent on their usual duties. The visitors saw not only the work room and apparatus, but the workers at work. After meeting the professors and

seeing the students it is easier to understand why Purdue University has been forging toward the front so rapidly within the past few years and why it is making a name for itself throughout the domain of practical and applied science.

\* \* \* \* \*

One of the pleasant features in prospect for attendants at the coming June conventions at Saratoga is that the headquarters for both associations will be at Col. H. S. Clement's famous Congress Hall. For five or six times now the conventions have been happily entertained at this roomy and well managed house, and the peculiar requirements of convention attendants are fully understood and met. As Colonel Clement gives space and steam free to exhibitors it would seem the correct thing for supply men to recognize the courtesy by "putting up" at Congress Hall.

\* \* \* \* \*

A chrouograph for recording exceedingly small intervals of time, such as a millionth of a second or less, has been used, says the Scientific American, to record autographically the compression, by a blow, of a cylindrical piece of copper. In one case a thirty-three pound weight fell fifteen inches and produced a permanent compression of 0.1658 inch in a copper cylinder, the time consumed in producing the compression being 0.0030317 of a second. The machine produces by photography a curve showing the progress of the compression. The chronograph consists of a rotating cylinder, and surface velocity of 100 feet per second, on which is photographed a pencil of light, which is passed through a hole in the end of a rapidly vibrating tuning fork. The delicacy of this instrument is far greater than that of the ordinary tuning fork chronograph, in which the record is made on a surface blackened by smoke.

\* \* \* \* \*

A simple and effective way of clearing rusted iron articles, no matter how badly they are rusted, consists, according to Carl Hering, in the Electrical World, in attaching a piece of ordinary zinc to the articles and then letting them lie in water to which a little sulphuric acid is added. They should be left immersed for several days, or a week, until the rust has entirely disappeared, and the time depending on how deeply they were rusted. If there is much rust a little sulphuric acid should be added occasionally. The essential part of the process is that the zinc must be in good electrical contact with the iron: a good way is to twist an iron wire tightly around the object and connect this with the zinc, for which a remnant of a battery zinc is suitable, as it has a binding-post. Besides the simplicity of this process, it has the great advantage that the iron itself is not attacked in the least as long as the zinc is in good electrical contact with it. When there is only a little rust a galvanized iron wire wrapped around the object will take the place of the zinc, provided the acid is not too strong. The articles will come out a dark gray or black color, and should then be washed thoroughly and oiled. The method is specially applicable to objects with sharp corners or edges, or to files and other articles on which buffing wheels ought not to be used. The rusted iron and the zinc make a short-circuited battery, the action of which reduces the rust back to iron, this action continuing as long as any rust is left.

**A NOVEL SPARK-ARRESTER—NORTHERN PACIFIC R. R.**

The spark arrester shown herewith at first sight appears like a useless monstrosity. But it is not. It is a thoroughly satisfactory construction that is proving its worth in daily service on the Northern Pacific. It was designed by Mr. H. H. Warner, master mechanic of that road at Tacoma, Wash. It is used upon a district of that road—about 300 miles long—upon which is found a local deposit of fuel strongly lignite in character. This fuel had been used, but always with much attendant danger from fire, all devices that had been tried failing to prevent the emission of sparks. Finally this device was made and has fully met the difficulties encountered in attempting to use the fuel, which was, aside from its spark-making, otherwise desirable.

As may be noticed in the diagram of the device and boiler that we give, the exhaust pipe is shaped as a reverse curve. This shoots the products of combustion from the front of the smokebox through a petticoat pipe which is so placed as to gather all the contents of the box freely and to pass them on

through the convex pipe attachment to the spark chamber on the top of the boiler. In this chamber is a dash plate, as shown, scattering the sparks, there being ample space above and beneath it for the passage of the sparks. The heaviest of the sparks fall to the bottom of the chamber, all being extinguished by contact with the exhaust. At the lower corners of the chamber are exhaust pipes intended to convey the sparks, which are deposited at the base of the chamber, back to the fire box. This is effected by a strong draft through the pipes created by steam jets placed at the connection of the pipes to the fire box. The light extinguished sparks are conveyed to atmosphere by the exhaust through the stack.

One can become accustomed to ungainly-looking devices, as this certainly is, especially when, as in this instance, it has become an acknowledged success in its operation and all danger from fire is elim-

average analysis representative of a good, strong No. 2 foundry iron:

Graphite Carbon	.....	3.81	per cent.
Combined Carbon	.....	0.19	per cent.
Silicon	.....	2.00	per cent.
Phosphorus	.....	0.416	per cent.
Sulphur	.....	0.013	per cent.
Manganese	.....	0.355	per cent.

When steel scrap is melted with pig iron in a cupola the effect is, of course, to increase the proportion of iron and decrease the other elements in direct ratio to the amount of steel added. Assuming that it is practicable to melt in a cupola 50 per cent of steel with 50 per cent of pig iron to make "semi-steel," a very simple calculation will show that the resultant metal still comes within the chemical classification of cast iron.

The diluting—if the expression may be permitted—of all of the elements, other than iron, has not been sufficient to bring the metal within, or even approximately near to the chemical classification of steel. Further-

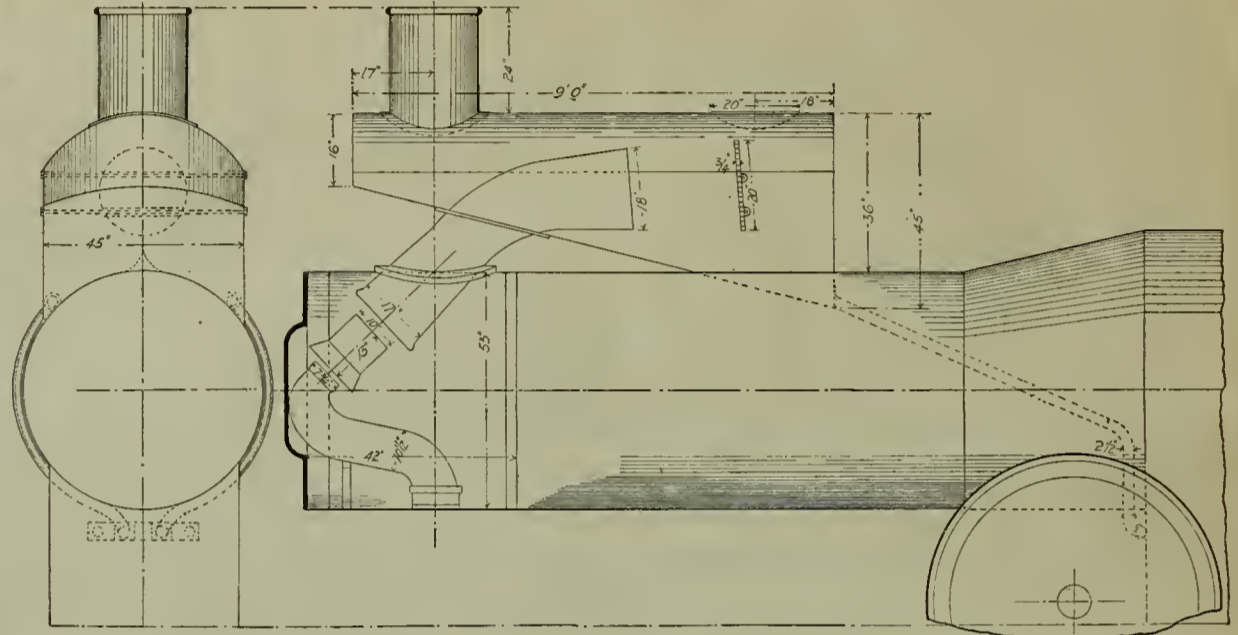

A NOVEL SPARK ARRESTER—NORTHERN PACIFIC RAILWAY.

inated by its performance. This arrangement is fitted to a number of engines running through the lignite district. It is stated that they are free steamers and that in the use of lignite they are economical.

**WHAT IS SEMI-STEEL?**

"Semi-steel" has been much talked of of late and is being often specified for locomotive parts. Considerable interest has been awakened concerning this product, and the following vigorous paper by Mr. Alexander E. Outerbridge, Jr., which appears in the last issue of the Digest of Physical Tests, will command marked attention. Mr. Outerbridge is an authoritative writer on metals, but his assertions as here given may arouse some opposition in certain quarters. His article is as follows:

Astonishing claims are now being made for a new metal called "Semi-Steel," and in order to call forth a prompt correction, in case of error, I propose to make here the assertion that there is no such metal as semi-steel, and furthermore, that the material so-called is not a new discovery.

The name semi-steel is, in my judgment, a misnomer and an altogether misleading term. It is, I admit, sometimes difficult to define the line of demarcation between steel and malleable iron, since one blends almost insensibly into the other, but chemical analysis of so-called semi-steel fails to show any close relationship whatever between this metal and steel, while physical tests are also equally widely divergent.

The following table represents fairly well the extreme variations in composition of each of these three forms of iron, viz., pig iron, steel and malleable iron:

Chemical Elements	Pig Iron. Per Cent.	Steel. Per Cent.	Malleable Iron Per Cent.
Iron	90. — 95.	98.5—99.5	99.5—99.9
Carbon	2.5 — 4.	1.5— 0.5	0.5— 0.1
Silicon	0.2 — 3.5	Trace.	Trace.
Sulphur	0.01— 0.5	Trace.	Trace.
Phosphorus	0.01— 1.5	Trace.	Trace.
Manganese	0.1 — 2.	0.01—2.	Trace.

N. B.—Special steels may, of course, contain much more manganese, others may contain nickel, etc., and traces vary.

The following composition may be taken as a fair

more, lowering the proportion of silicon to one-half of the original content has the effect of causing nearly all of the carbon to remain chemically combined with the iron when quickly solidified, leaving a small proportion only of uncombined or graphitic carbon; this greatly increases the chilling property of the metal, and causes it to become white or mottled in light castings. In order to prevent this occurrence it is customary to add a certain percentage of silicon, usually in the form of high silicon pig iron, in the cupola; this prevents, in a measure, the overturn of carbon from graphite to combined carbon, and keeps the metal gray; but it still further widens the breach chemically and physically between steel and this metal improperly called semi-steel.

The simple fact is that the melting of steel with pig iron causes the steel to lose its identity completely, but the pig iron does not thus lose its characteristic qualities, and the resultant metal is simply a strong, close grain cast iron, which has neither chemical nor physical relation nor resemblance to steel, and, therefore, the popular term "semi-steel"—which some manufacturers have adopted with eclat—is misleading.

With regard to the novelty of the discovery, it can be shown that the process is more than fifty years old, and was practiced in England long ago.

Sixteen years ago, while in charge of the metallurgical department of a car-wheel establishment which operated under the "steeled wheel" patents of William G. Hamilton and George Whitney (a process of melting steel scrap with pig iron to increase the chilling property of the metal), a distinguished engineer, Sir Frederick Bramwell, formerly in charge of the metallurgical and gun-making department of the Woolwich Arsenal, England, visited the works. He was particularly interested in the car-wheel metal mixture of steel and pig iron, and said that it was similar to a process with which he was familiar in his youth called "Stirling's toughened cast iron," and on his return home he wrote to me as follows:

"I have much pleasure in enclosing the specification of Stirling's patent of 1846 [No. 11,262]. See page 3, line 18, forward. . . . Stirling continued to patent metallic alloys up to 1854."

The marked paragraph in the specification is as follows:

"For certain purposes, such as shaftings, cranks for steam engines, girders or beams, guns or ordnance, and where a metal possessing greater tenacity or

strength than ordinary cast iron is required, and where it is an object to vary the degree of hardness, I make a mixture of wrought iron and cast iron as follows: (Here follow details which are unnecessary to the elucidation of this topic.)

"I would remark that cold blast iron, or iron containing the lesser quantity of carbon, will require a smaller addition of wrought iron than hot blast iron, or iron containing a larger quantity of carbon; but I find the addition of from about one-third to one-fifth of wrought iron to answer well in the generality of cases where increased strength, toughness, and tenacity are required. The above compound may also be made of iron from the puddling furnace after it has been treated, so as to get rid of the scoria, but a larger proportion of such iron will be required. These mixtures of cast and wrought iron may be conveniently called 'toughened cast iron.'"

Wrought iron and steel are so nearly alike in composition that they may be considered as identical for the practical purpose of melting with pig iron, the advantage, if any, resting with wrought iron, as that is a purer metal than steel.

The term which Stirling applies to his metal is not "semi-wrought iron" nor "semi-steel," but "toughened cast iron"—a perfectly correct designation.

It is claimed that castings made of semi-steel have extraordinary strength. Published tests show as high, I believe, as 40,000 pounds tensile strength per square inch, or possibly more. Does this really represent the strength of a casting, or simply the strength of a comparatively small test-piece?

Cast iron differs radically from cast steel not only in its composition and its physical properties, but in the fact that it is subject to great modification of its properties according to the rate of cooling of the mass. A large and a small casting poured from a ladle of steel will not greatly differ in the quality of the metal, but two castings of different size poured from one ladle of cast iron may be entirely different in the character of the metal. If the metal is high chilling iron, a small casting may be perfectly white, hard as flint and brittle as glass. A large casting from the same ladle may be perfectly gray, tough and ductile. A medium sized casting may have a "lively" gray color, a close crystalline fracture, and higher tensile strength, with comparatively little ductility or resilience.

The rate of cooling is such an important factor in determining the quality of cast iron that it is entitled to be regarded as a characteristic function of the metal. For these and other reasons the recent suggestions of Dr. R. Moldenke regarding the importance of the adoption of a standard system of preparing test bars for cast iron which will indicate, approximately at least, the strength of the castings they represent, are both timely and valuable.

The contributions of Thos. D. West, S. S. Knight, Malcolm McDowell, and some others have also advanced foundry scientific literature to a much higher position in the estimation of chemists and metallurgists than it formerly held.

More or less vague claims are made for the beneficial effect of adding to semi-steel small doses of various "medicines," usually in the shape of coarsely ground or crushed alloys into the ladles of molten metal, but it is not difficult for the chemist or metallurgist to ascertain what alloys of metals, or chemicals, are suitable and available for treating cast iron in the ladle or in the cupola; and while I believe that such treatment may be, and often is, beneficial, I am exceedingly skeptical regarding many claims that have been put forward in recent years, with the accompaniment of elaborate tables that give an air of scientific accuracy or acumen to such disquisitions, but are sometimes found on closer scrutiny to be full of contradiction and absurdity. While I do not desire herein to criticize any particular writer or article, I think it is time to call a halt upon hasty compilations of half-digested experiments of amateurish investigators, which are put forward often through the medium of proceedings of technical societies of high standard. More careful examination of such papers before acceptance would avoid the dissemination of erroneous statements, or the necessity of withdrawing them after they have appeared in print.

With respect to the claims for so-called semi-steel, I reiterate my statement made at the beginning of this paper, that there is no such metal, and that the metal so called is by no means new to metallurgists. I do this, as already stated, for the purpose of inviting contradiction to my statement of facts, and not to disparage the work of any individual.

I am a seeker of knowledge, and wish to be assured of the correctness of that little which I have gained in a long course of years, or else apprised of my errors. An important contribution to this literature, which bears critical examination, entitled "Value of Metalloids in Cast Iron," was presented by Major McDowell to the Western Foundrymen's Association January 19,

1898. Tests made at the Watertown Arsenal of two bars of Major McDowell's "enpola steel" cast 1½ in. round, turned to 1.129 in., showed tensile strength 42,820 lbs. and 46,400 lbs. per square in. Two bars cast 1 in. square, turned to .564 in., showed 45,840 lbs. and 49,200 lbs. tensile strength per square inch. It will be noticed that the smaller bars were the stronger. The bars used by the Major to determine the "machinability" of the metal were 4-in. diameter.

Had the tensile test bars been cast of this size, or larger, and turned down to 1.129 in., I believe that the strength per square inch would have been far less, for the published analysis of the metal indicates that it is strong cast iron, subject to the law of cooling of that metal, which I have endeavored to enunciate in this and other papers upon the subject.

**CONTRACTING MOULDS SUGGESTED TO PREVENT PIPING OF INGOTS.**

During the discussion of a paper on iron and steel forgings, by Mr. H. F. J. Porter, at a meeting of the Franklin Institute, the following suggestive dialogue was had:

Mr. A. E. Onterbridge, Jr.—Have investigations been made to determine whether the expansion of the iron ingot mould, caused by the heat of the molten steel, affects the density of the ingot? In other words, do you think it is possible that "piping" may be due, in part, to the receding of the mould from the ingot while the latter is still in a semi-fluid or a plastic condition?

Mr. Porter—The "sink-head" or added length of ingot supplies metal by ferrostatic head as the mould expands. The fluid compression prevents piping by adding to the ferrostatic head, and forcing the metal of the sink-head down into the "pipe."



MOGUL FREIGHT LOCOMOTIVE—GRAND TRUNK RAILWAY.

Mr. Onterbridge—The question was suggested to my mind by my experience with cast iron, more particularly in the special work of casting car wheels. Formerly, a simple "chill ring" was used to suddenly cool the casting and to form the hard-chilled tread of the wheel; this ring expanded when heated by the molten iron, so that, in a few moments, after a wheel had been poured, it was possible to insert a knife-blade between the chill ring and the casting; moreover, the space was usually greater upon one side than upon the other, owing to some accidental cause, such as a draft of air striking one side of the chill ring, and the effect upon the wheel was apparent when it was broken in order to examine the fracture, the chilling effect being deeper on one side than on the other. To overcome these defects, a very ingenious invention was made some years ago, now known as the "contracting chill;" this is a double ring, or rather two concentric rings connected by webs or radial arms, the inner ring being divided, by sawing, or otherwise, into a hundred or more separate segments, each segment being attached to the outer ring by a single arm. When the sectors of the inner ring become heated by contact with the molten metal, they all simultaneously move inwards toward a common center, because the radial arms grow longer when heated, and the cold outer ring prevents any movement outwards. This contracting chill, therefore, follows up the casting as it cools and hugs it closely, thus producing a uniform chilling effect upon the periphery of the wheel and preventing annealing of the chilled metal, or return of the combined carbon to the graphitic form. The purpose of my inquiry was to ascertain whether this ingenious principle has been applied to ingot moulds, and if no such experiments have been made, would it seem to you a priori likely that a contracting, instead of expanding, iron ingot mould might tend to produce a denser ingot, and thus to prevent or diminish piping?

Mr. Porter—I am unable to say whether any work has been done in this direction or not. I imagine not, however, as the large masses of steel usually cast require moulds built very rigidly to resist the enormous internal pressure.

**MOGUL FREIGHT LOCOMOTIVE—GRAND TRUNK RAILWAY.**

From designs supervised by Mr. F. W. Morse, superintendent of motive power of the Grand Trunk Railway, the Schenectady Locomotive Works have recently built for that road six mogul freight locomotives. These engines are just entering service, and we understand that their initial performance gives excellent promise of exceptionally satisfactory results. Our excellent photographic view of one of these engines, together with the appended data, afford a fair idea of the general design and detail followed:

GENERAL DIMENSIONS.

Gauge .....	4 ft. 8½ in
Fuel .....	Bituminous coal
Weight in working order.....	152,850 lbs
Weight on drivers .....	127,650 lbs
Wheel base, driving.....	15 ft. 8 in
Wheel base, rigid.....	15 ft. 8 in
Wheel base, total .....	24 ft. 1 in

CYLINDERS.

Diameter of cylinders.....	20 in
Stroke of piston .....	26 in
Horizontal thickness of piston.....	5½ in. & 5¾ in
Diameter of piston rod.....	3¼ in
Kind of piston packing.....	Cast iron rings
Kind of piston rod packing.....	United States Metallic
Size of steam ports.....	20 in. x 1½ in
Size of exhaust ports.....	20 in. x 3 in
Size of bridges.....	1½ in

VALVES.

Kind of slide valves.....	Railway company's style
Greatest travel of slide valves.....	5½ in
Outside lap of slide valves.....	7/8 in

Inside clearance of slide valves.....	1-16 in
Lead of valves in full gear.....	Line and line
Kind of valve stem packing....	United States Metallic

WHEELS, ETC.

Diameter of driving wheels outside of tire.....	62 in
Material of driving wheel centers.....	
.....Main, cast steel; f. and b., steeled cast iron	
Tire held by.....	Shrinkage and retaining rings
Driving box material.....	Steeled cast iron
Diameter and length of driving journals.....	
.....	9½ in. dia. x 12 in
Diameter and length of main crank pin journals..	
.....	6½ in. dia. x 6 in
Diameter and length of side rod crank pin journals (Main, side 7½ in. dia. x 5¼ in.); f. and b.	
.....	5½ in. dia. x 4 in
Engine truck, style.....	2 Wheel, swing bolster
Engine truck, journals.....	6½ in. dia. x 10½ in
Diameter of engine truck wheels.....	37 in
Kind of engine truck wheels.....	
.....	Steel tired, cast iron spoke center

BOILER.

Style .....	Extended wagon top
Outside diameter of first ring.....	62 in
Working pressure .....	200 lbs
Material of barrel and outside of fire box.....	Carbon steel
Thickness of plates in barrel and outside of fire box .....	21-32 in., ¾ in. and ½ in
Horizontal seams .....	Butt joint, sextuple riveted, with welt strip inside and outside
Circumferential seams .....	Double riveted
Fire box, length.....	120 in
Fire box, width .....	40⅞ in
Fire box, depth.....	F. 73¾ in., b. 65 in
Fire box, material.....	Carbon steel
Fire box plates, thickness.....	Sides, 5-16 in.; back, ¾ in.; crown, ⅜ in.; tube sheet, ½ in
Fire box, water space.....	
.....	Front, 4 in.; sides, 3½ in.; back, 4 in
Fire box, crown staying.....	Radial stays, 1½ in. diam
Fire box, stay bolts.....	Ulster Special iron, 1 in. diam
Tubes, material.....	Charcoal iron, No. 12 W. G.
Tubes, number of.....	291
Tubes, diameter .....	2 in
Tubes, length over tube sheets.....	11 ft. 11 in

Fire brick, supported on.....	Three 3-in. water tubes
Heating surface, tubes.....	1800 sq. ft
Heating surface, water tubes.....	15.15 sq. ft
Heating surface, fire box.....	185.85 sq. ft
Heating surface, total.....	2001.00 sq. ft
Grate surface.....	33.44 sq. ft
Grate, style.....	Rocking, railway company's standard
Ash pan, style.....	Sectional, dampers f. and b.
Exhaust pipes.....	Single
Exhaust nozzles.....	4¾ in., 5 in., 5¼ in. and 5½ in. diam
Smoke stack, inside diameter.....	16 in
Smoke stack, top above rail.....	14 ft. 2¼ in
Boiler supplied by.....	Two
Inspirators, Hancock type "A" No. 10, placed r. and l.	

TENDER.

Wheels, number of.....	8
Wheels, diameter.....	33 in
Journals, diameter and length.....	5 in. dia. x 9 in
Wheel, base.....	16 ft. 6½ in
Tender, frame.....	10-in. steel channel
Tender trucks.....	
Center bearing with side bearing on back truck	
Water capacity.....	4500 U. S. gallons
Coal capacity.....	10 (2000-lb.) tons
Total wheel base of engine and tender.....	50 ft. 10 15-16 in
Total length of engine and tender.....	61 ft. 8 7-16 in

SPECIAL EQUIPMENT.

- Engine equipped with:—
- 3-3" Coales Safety Valves. One muffled; two encased.
- Detroit triple sight feed lubricator, with Tippett device.
- American outside equalized brake on all drivers, operated by air.
- Westinghouse automatic air brake on tender and for train, 9½" air pump.
- Houston sand feeding apparatus.
- Tender brake beams, Sterlingworth, Marden patent.
- 6" Chime whistle, No. 3 Crosby.
- Two Ashcroft steam gauges.
- Consolidated car heating apparatus.

THE M. C. B. COUPLER.

In our last issue we gave an article, in our editorial columns, on the M. C. B. coupler, pointing out some of its defects and referring to the current private discussion as to methods of increasing its strength. Of the letters of comment that have come to us we are permitted to publish the following:

FROM MR. A. M. WAITT.

I have read the article on M. C. B. couplers in your April issue. The present tendency seems to be undoubtedly in the direction of greatly increased capacity of cars: as a result of this, cars in motion will have much greater momentum, and all the parts of the equipment will be subject to greater strain. The present M. C. B. couplers were undoubtedly designed for cars of lighter capacity than many now in service. Unfortunately they were designed on such lines as to prevent their being properly strengthened within the same limiting dimensions. It is an open question whether the present M. C. B. lines are ideal in the way of producing a thoroughly satisfactory automatic coupler. I do not see any use in trying to strengthen one part of the present coupler, for instance the shank, and leave the head and knuckle the same as they are at present, for the coupler as at present made divides the breakage up between the knuckle, coupler head, and shank in quite even proportions. If any general strengthening of the couplers is to be accomplished, it will in the end necessitate heavier knuckles, therefore a head which will not couple with the present heads. If such a change is sought for, it seems to me it would be better for an able committee of experts, from both the manufacturers and the railway men, to see if a design of coupler can be worked out, not necessarily on the present lines, but which will be large enough and strong enough for cars of double the present generally adapted capacity of 60,000 lbs., and in connection with it design a simple connecting piece that will enable one of the suggested new design of couplers to be properly connected with the present M. C. B. type. It is too late a day, in my opinion, to attempt to patch up and make strong and satisfactory the present M. C. B. coupler which is far from ideal, although it is a vast improvement and source of economy as compared with the link and pin coupler.

FROM MR. GEO. W. CUSHING.

I have become interested in your article in the April MASTER MECHANIC referring to M. C. B. couplers. It is true that some of the objections now made to the type were urged at the time of its adoption, as I remember, and it would seem that with the increase of train weights, and of the coupler also, the troubles, expense and delays have not decreased and that the defects are still in evidence. It is not the time now to create or to add objections to the type; but it may be practicable to improve on the attachments or means

for side play, and to remove a portion of them, especially as it is correctly stated that in extreme instances trains and tenders have been derailed by reason of the great side pressure on bars in passing curves.

In the experiments with the first automatic coupler on passenger equipment—the Miller hook—some 30 odd years ago, it was demonstrated that without considerable side play from a central position it would be impossible to pass curves: hence the proper amount was provided for on cars then used. The flat side spring now used held the hook in its proper normal position, but permitted about 5 in. side motion at the point of hooking. A variety of plans to utilize this motion with a certain return to proper place as the pressure released on the side of the hook were devised; all of them called for some form or arrangement of springs, and there are several now in use. Any of these may be arranged on freight cars now, in modified form. It will not be a popular proposition, as it adds to the cost of cars and it will add to the care of inspection; but the motion is at times necessary, as it was with the old link and pin arrangement, and it will remove this objection of side rigidity in the M. C. B. type of coupler.

Your article further on refers to an increase in strength of coupler as desirable. We now have malleable iron and steel bars. When malleable iron bars are made equal in strength with the steel bars there will not be any objection of this kind made. If cheap materials are preferred the quality is not likely to be maintained; but this should not be a proper objection to the M. C. B. type of bar. Good material—even the best—is and has been for years available.

In a test of strength for bars, why should not all materials stand on the same footing and one specification cover them for the same service? This, it seems to me, is the proper way to increase the strength of bars—make the requirements such as to necessitate the use of best grade of material available, and make them general.

There is steel used in draw bars to-day of the following well-known characteristics, viz.: 65,000 to 75,000 lbs. tensile strength to the square inch, with 35,000 to 45,000 lbs. elastic limit per square inch, with 15 to 20% elongation in 8-in. section, and below .04 in phosphorus and sulphur. This will be at once discovered by practical people to be the embodiment of high-grade or first-class steel, double the strength of malleable iron bars. These bars are M. C. B. standard weight, 226 lbs., except otherwise ordered by purchaser, and the factory making them is well known. It uses the same average grade of material in all work daily.

PNEUMATIC HAMMERS.

Perhaps nothing in the arts has made more rapid strides in the last five or six years than the introduction of compressed air into our shops and factories. So varied are its uses and such economical results are obtained from its application that the air plant has become an indispensable part of the equipment of the modern shop or factory. Prominent among the various devices for its application are the pneumatic hammers for chipping, calking, beading and riveting, which are to be found in all first-class foundries, machine shops, boiler shops, bridge works and ship yards of to-day. As might be expected, the early tools of this class, while very ingenious devices, met with but limited success: partly, from the fact that the workmen into whose hands they were placed were not familiar with their use, but principally from defects and imperfections in the tools themselves being more or less erratic and uncertain in their operation, severe on the operator and difficult to keep in repair. They were most always encumbered with intricate valves, which were a constant source of expense for repairs. Small ports and tortuous passages or other complicated parts of construction caused endless repairs and annoyance. The Ridgely & Johnson Tool Company, of Springfield, Illinois, by the application of scientific principle, balancing of the moving parts and simplifying the construction, have succeeded in producing a machine of very high efficiency and easy of manipulation, and in which the cost of repairs is reduced to the minimum. It covers a wide range of work from the lightest chipping and calking tools up to machines large enough to drive 1¼-in. rivets. The simplicity of construction and durability of these tools will be at once apparent, by reference to our engravings.

Figure 1 gives a longitudinal sectional view of the single hammer. B is the cylinder made of tool steel hardened and accurately ground inside and out. A is the bronze handle fitting over the steel cylinder and secured in its place by means of the cap F, which screws into the steel cylinder and draws it firmly back against the shoulder of the handle. E

is the striking piston, the back end of which is larger in diameter than the main body, forming a collar or head which fits the larger bore of the cylinder, the smaller diameter of the piston fitting the smaller bore of the cylinder. This piston is also made of tool steel hardened and accurately ground. D is a removable ferrule pressed into the front end of the cylinder and bored to receive the shaft of the tool. This is also hardened and can be easily withdrawn and replaced when worn. J is the chamber of the counter-balanced throttle valve; K is the valve; H

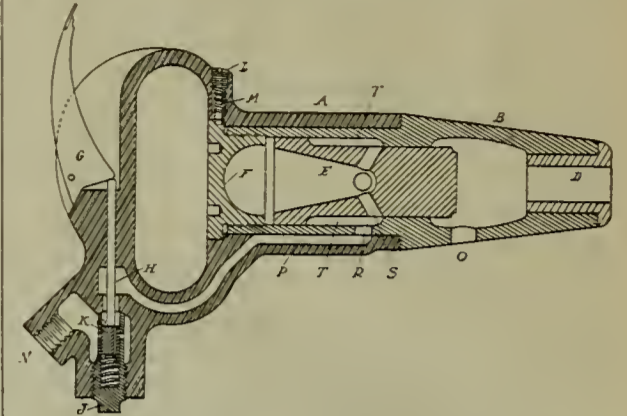

FIG. 1.—DETAILS OF SINGLE HAMMER.

the stem and G the lever. All of these parts are made of tool steel hardened and ground. N is the hose connection; O the exhaust port, and S the ports opening into the hollow portion of the piston. R is a port for admitting air in the chamber T. P is the air passage through which air is admitted from the throttle to the chamber T. M is a pawl which engages a ratchet on the rim of the cap F. L is a spring and nut holding the pawl in place. Should it be desired to remove the cylinder from the handle, by simply raising this pawl out from the ratchet the cap F can be unscrewed by means of a spanner furnished with the machine and the cylinder drawn out of the case, when the piston can be removed from the cylinder.

In the operation of the machine, by pressing on the thumb lever G air is admitted through the throttle K and the air passage P and port R into the chamber T maintaining a constant pressure in this chamber as long as the throttle is opened. With the piston in the position shown in the cut the air would pass through ports S to the inner chamber and fill the cylinder at the rear of the piston. This being so much greater in area than the shoulder formed by the enlarged part of the piston, the piston would be forced forward to impact upon the tool, which is inserted through the front end of the machine. When, however, the piston has passed forward until the ports S pass the shoulder formed by the smaller bore of the cylinder, which represents one-quarter of the movement of the piston, the inlet of air to the rear of the piston is cut off and the expansion of the air in the inner chamber carries the piston forward to the end of the stroke. At the same time the openings S are brought into communication with the exhaust O, which instantly relieves the pressure behind the piston: then by virtue of the constant pressure in the chamber T the piston is again returned to the position shown, when the same cycle of operations are repeated in rapid succession.

In Figure 2, which is a sectional view of the counter-balancing hammer, showing the two pistons in the two extreme positions, E is the cylinder and A is the handle, which, as in Figure 1, slips over the cylinder and is held in place by means of the cap B, which is prevented from unscrewing by means of

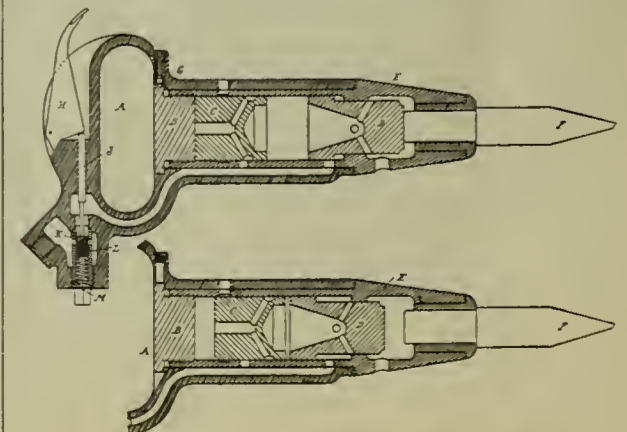

FIG. 2.—DETAILS OF COUNTERBALANCED HAMMER.

the ratchet and pawl G. M is the throttle chamber, K the hose connection, L the throttle valve, J the stem and H the lever. D is the striking piston. C is the counter-balanced piston and F the tool. Like the single hammer, all moving parts are made of the best tool steel hardened and ground. In the operation of this tool, assuming position shown in upper view in Figure 2, supposing air to be admitted through the throttle and, by means of the ports shown, under the shoulder of the striking piston D and to the rear of the counter-balanced piston C, this would force the two pistons simultaneously to the center of the cylinder, as shown in the lower view. Then the ports through the striking piston D coming into communication with the constant pressure chamber, air is admitted into the cylinder between the two pistons, which forces the striking piston forward to the tool F and the piston C to the rear of the cylinder, as shown in upper view, when the same cycle of operations would be repeated in rapid succession. It will be noted by reference to the drawing that when the piston C has moved forward about one-eighth of its stroke the air inlet to its rear is closed and the expansion of the air at its rear is the only impelling force to carry it forward for the remainder of the stroke. Also when it is driven back the air in its rear, being confined, must be compressed and thereby act as a cushion to absorb the energy and bring it to rest before striking the cap B. The weight and motion of these two pistons are so proportioned that the recoil of one is exactly counter-balanced by the other, thereby relieving the operator of the severe jar which has heretofore been a serious objection to some pneu-



FIG. 3.—NO. 2 YOKE RIVETER 16 IN. YOKE.

matic tools for heavy work. This machine can be held with ease with one hand while doing the heaviest chipping or driving up to 1/2 in. rivets hot. Both the single and counter-balanced hammers are made in a number of different sizes to suit various classes of work.

The counter-balanced feature is also introduced into what the company terms a duplex riveter, which is a machine weighing about 35 lbs. and can be held easily by one man while driving up to 3/8 in. rivets hot.

For heavy riveting in ship yards, structural works, bridge works and car shops the company makes a yoke riveter, shown in Figure 3, which consists of a hammer, of the same general type as that shown in Figure 1, mounted upon one arm of a yoke and a pneumatic hold-on mounted upon the other arm of the yoke. These machines are built in several sizes, and with capacities up to 1 1/4 in. rivets, and in yokes of any depth up to 7 or 8 ft. The Ridgeley & Johnson Company have a great many of these machines in successful operation in ship yards and structural works, and it is claimed that the cost of riveting by their use is reduced more than 50%.

**The Railway Master Mechanic and Recreation.**

Further arrangements enable us to offer to new subscribers the RAILWAY MASTER MECHANIC and the monthly magazine, Recreation, for twelve months for one dollar.

Recreation is devoted to hunting, fishing, canoeing,

and kindred interests, and is the most satisfactory magazine of the kind published.

Old subscribers to the RAILWAY MASTER MECHANIC can have Recreation sent them for one year by enclosing an extra fifty cents.

**ELECTRIC DISTRIBUTION OF SHOP POWER.\***

BY GEORGE GIBBS.

The general subject covered by the title of this paper has been much discussed during the past year or two in the technical press and in engineering societies, but most fully from the standpoint of relative economy in power consumed for the electric and the belting systems of transmission. I propose, therefore, to briefly only touch upon this phase of the subject, confining attention to an elementary description of the different types of apparatus on the market and comments upon their relative suitability for railway shop work, with hints as to character of the installation, thus giving the motive power man some idea of the suitability of electric driving for his especial uses and the approximate investment required.

For useful data upon losses in factory power transmission, and upon the use of electric motors in shops, the reader is referred to papers by Profs. C. H. Benjamin and D. C. Jackson in the proceedings of the American Society of Mechanical Engineers, Vol. 18, for 1897; also to a paper on "Alternating Currents—Some Recent Advances," by Mr. Chas. F. Scott, in the proceedings of the Engineers' Society of Western Pennsylvania, December, 1897.

**ECONOMY OF SHAFTING TRANSMISSION.**

The following data is largely taken from Prof. Benjamin's paper, with additions from my personal experience, which harmonizes therewith. The figures apply only to "heavy machine" work, such as found in railway shops.

The average friction horse power to drive belts and shafting, from engine pulley to machine pulley, in a number of shops was 52 per cent of total power used. In a planing mill the friction horse power was 63 per cent of total. This latter figure is somewhat less than I found to be the case in the planing mill of the C., M. & St. P. Ry. at Milwaukee, where 500 indicated horse power was used for average loaded mill, and 375 horse power, or 75 per cent, to drive the shafting, etc., with all machines idle.

Other figures given by Prof. Benjamin are: Friction horse power per 100 feet of shafting, average 5.57; useful horse power per machine average, 0.45, with considerable variation between extremes, running from 0.7 down to 0.16 horse power; useful horse power per man, average 0.38, varying from 0.88 to 0.14 horse power.

As the work done upon shop product is made up of energy expended upon it by the power-driven tools and through the agency of the workmen, the relative costs of these will naturally vary largely; but in shops devoted to heavy machine work it has been ascertained that the power cost for tool driving is seldom more than 2 per cent of the labor cost.

It is thus seen what a relatively unimportant consideration any probable savings in power cost from improved transmission plants becomes in comparison with appreciable savings in the labor bill or augmentation of quantity in shop output. This leads us to the conclusion that we should first strive to arrange our transmission plant with reference to labor efficiency and convenience, rather than power efficiency.

[Mr. Gibbs here follows with a description of the apparatus comprising an electric power plant and then takes up the matter of the selection of the proper apparatus for railway shop use, as follows]:

**LAYING OUT AN ELECTRICAL SYSTEM.**

The main point to be kept in mind is a desired increase in efficiency of the shop plant in turning out product with a reduction in the time and labor items, without especial reference to the fuel item involved in the power production; in other words, we should aim to facilitate quick handling of the materials of manufacture and give increased scope to the use of labor saving and portable tools.

**Character of the Plant.**—The above objects involve a combination of group-driven tools, motor-driven handling machinery, and individual driving for isolated or portable tools.

Considering these in order: Group-driving should be adopted for small machine tools which are compactly arranged, and to the extent that further subdivision in driving would not result in improved operation of the tools, or permit a more desirable method for handling material to and from them; handling machinery should be introduced to the fullest extent justifying the investment, as shown by labor savings, or by equivalent benefits in increasing the shop product; lastly, individual driving should be introduced as required by the above, or for isolated and intermittently running and portable tools, for which a large field is thus opened for the exercise of ingenuity of the mechanic.

**Selection of System.**—It is difficult at present to take

\*Abstract of a paper presented by George Gibbs before the March meeting of the New York Railroad Club.

a very decided stand for or against either of the two general systems of distribution—namely, the direct or the alternating. Either is well adapted for shop apparatus, with the chances that the alternating system will largely displace the direct in future.

**Voltage of Current.**—In nearly all shop electric installations, it is desirable to furnish current for motors and for lights from the same generator and circuits, thus avoiding additional apparatus and complication. The quality of light furnished in this way is not apt to be as regular as when a separate lighting dynamo is employed, on account of the variable drop in pressure caused by unequal motor loads on various parts of the wiring system at different times; but this resulting variation in light is generally not sufficient to be objectionable for ordinary shop manipulation, and the practice of combining the light and power circuits is to be recommended.

Generators are commonly built for 125, 250 and 500 volts pressure; and allowing for ordinary drop in lines, these would correspond to motor pressures of 110, 220 and 500 volts, respectively.

The 110 and 220-volt motors are in most common use for shops; 500 volts is employed for electric railway purposes, but is undesirably high for stationary motors.

Luculent lights are made for 110 and 220-volt circuits, and "constant potential enclosed type" arc lamps run on 110-volt circuits, or on 220-volt, if placed in two in series. All things considered, therefore, I believe the proper voltage for shop power generators is 250 (corresponding to 220 at the motor), the reasons being that the brushes on both generator and motors work best at this voltage; the cost of the wiring system to distribute currents may be kept within reasonable limits; this pressure is not dangerous to life, or even disagreeable to handle, and is not too high for maintenance of insulation; either incandescent or arc lamps may be run between the circuits; and, lastly, it is very desirable to lend assistance in establishing some standard pressure which may be generally adopted, and 250 volts appears to best meet all of the conditions of present practice.

**Type and Size of Generator.**—It is difficult to make general recommendations upon this heading, since local conditions will greatly modify suggestions made to fit a particular case.

This much may be said: the best type of generator for combined light and power purposes is the multipolar with compound winding on its fields, and with an iron-clad armature having its winding imbedded below its surface and held in place by wedges—not band-wires. If of direct current type, it should have carbon brushes bearing upon commutator, and these should require no shifting in position with change of load from no load to 50 per cent overload.

These machines are usually made to run by belted attachment when in sizes below 100 horse power, and may be so run in larger sizes, say up to 300 horse-power. When belted in sizes of 100 horse-power or more, it is very desirable to provide an out-bound bearing at the pulley end, so that excessive wear and heating of bearings may be prevented. The 100 horse-power unit may, however, be roughly taken as the dividing line between a belted and a direct connected rig, all machines above this size being made for direct attachment to the engine shaft.

The advantages of a direct connected rig are: Compactness, positive driving action, absence of excessive bearing friction due belt pull, lower speed and somewhat more solid construction (in small machines) due greater size of parts.

The advantages of belted rigs are: Cheapness due higher speed, which means more output for same weight of material; ready applicability to existing engine plants, provided space is sufficient; ease of repair, the dynamos being separate from the engine, and perfect insulation.

In planning the installation of a transmission plant with small beginnings, for running, say, one electric traveling crane, transfer table, turn-table outfit, and a few portable tools, a 75 or 100 horse-power belted generator will be found a convenient unit size. It may be installed cheaply by belting from countershaft at the main shop engine, but it is altogether better to provide a separate engine, for the reasons that the electric drive may be needed 24 hours in the day for special work (such as roundhouse turntable); and it makes a good emergency power plant for portions of the shops working overtime, by belting a portable motor to a section of the line shaft, or to a large single tool—such as a wheel lathe. It may be also used at nights to light the roundhouse and other buildings. When the transmission plant outgrows the capacity of this generator, it may still be used as a "spare," or for overtime work.

In laying out a complete system of electric transmission, careful attention should, of course, be given to selection of unit sizes; little advice can be given off-hand for such a case. In large plants, say, of 400 or 500 horse-power, there should be two and possibly three units of the direct connected type and selected so that the engines shall run as far as possible at economical loads, and that one unit may be thrown out of service for emergency repairs. I do not mean that of necessity a spare unit shall be provided; this is desirable but not essential, as it is seldom that emergency re-

pairs cannot be made overnight, and regular repairs between Saturday and Monday morning; and with electric driving having divided distribution, it is generally easy to shut down certain portions of a shop when necessary to temporarily reduce the generator load for repairs, without serious inconvenience for a few hours. This is one of the advantages of groups or individual driving over the line shafting method.

**Calculation of Load on Generator.**—This can be made quite readily from published data on power required to run machine tools. It is usual, as stated elsewhere, to install motors having a considerably larger nominal capacity than figured requirements, so that generator capacity need never be as great as the added capacities of motors attached; in fact, the generator load in an ordinary shop seldom runs above 50 per cent of that of the combined motor capacity, and in shops having a larger motor load the effect on generator of running a traveling crane, a transfer table and turntable, need not be considered, as the momentary overload capacity of the machine will be ample to take care of such requirements.

**Rating of Generators.**—Generators are sold with a guarantee to deliver their rated capacity, when driven at a certain speed, indefinitely, with a maximum temperature rise, due to electrical losses, of an amount supposed not to be injurious to insulation; this rise should not exceed 40 degrees centigrade above the temperature of the surrounding air. They are also guaranteed to carry an overload of 25 to 50 per cent for two hours, and short-period overloads of 100 per cent without injurious heating. These guarantees have led to an objectionable but common practice of figuring the engine size on the overload capacities; that is, it is quite customary to couple a generator to an engine having its economical rated capacity equal to the 50 per cent overload capacity of the generator. The consequence is that load is piled on the generator as long as the engine will pull it without seriously dropping off in speed, and an expensive generator is finally ruined for lack of common sense precaution which would be furnished by a properly adjusted engine unit.

**Efficiency.**—The efficiency of a modern dynamo is excellent over a wide range of loading; machines of 100 horse-power and upward will put out in the shape of useful current at their terminals 92 to 93 per cent of the power supplied at the armature shaft; at partial loading the efficiency will fall off slightly, being about 90 per cent at half and 86 per cent at one-quarter load.

**Motors, Direct Current System.**—For belted connection to either line shafting or individual tools, the constant speed shunt motor is the best. This should be of the multipolar type, and is preferably of "open" construction; that is with the commutator and ends of field frame exposed. I say preferably because, first, it is very desirable to have the brushes and connections in view and readily adjustable, and the whole machine accessible for cleaning from oil and dirt; second, the open type is better ventilated and runs much cooler than the enclosed, which means economy in first cost and repairs. Except where exposed to the wet or to mechanical injury from articles falling into it, there is really no valid objection to the open type motor for belted connection, and it is certain to be taken better care of than the enclosed, where apparent simplicity and the difficulty of access are made excuses for neglect.

For traveling cranes, hoists, transfer tables, locomotive turntables and boiler shop plate rolls, a different type of motor is best; starting under load, variable speed running, stopping and reversing is the cycle of operations for such purposes. The series-wound motor is therefore used; and is preferably of the enclosed style, which allows of more universal connection in any position, by gearing or otherwise, than the open type—the question of heating being not so serious on account of intermittent running. When geared, this motor should, if possible, have its frame flexibly mounted to reduce the shock of starting.

**Selection of Motors.**—In installing a motor plant, I believe it of importance to keep down the number of different sizes and types, and would do so at the expense of some waste of power, due to the reduced efficiency of underloaded motors, especially as their reliability is enhanced thereby.

Competition among the makers of cheaper grades of motors has resulted in giving ratings dangerously close to the maximum safe working limit, and a reduction in the working load greatly increases the durability of the machine.

TABLE NO. 1—EFFICIENCIES OF MULTIPOLAR MOTORS.

Horse Power Rating.	Efficiency Per Cent at		
	Quarter Load.	Half Load.	Full Load.
1	40	58	70
2	47	68	78
3½	57	70	79
5	60	73	83
7½	65	78	85
10	70	81	86
15	70	81	87
20	73	82	88
30	76	84	90
50	76	85	91

The effect of variation of load upon the efficiency of

standard motors is shown in Table No. 1; the efficiency will be seen to fall off quite seriously at one-quarter load on the smaller sizes, but the actual amount of power so wasted is not very serious after all.

In deciding upon the make of motor to be purchased, there is the same range for selection as found in other lines of machinery; but as an electric motor is a somewhat delicate machine and liable to diseases of a mysterious nature and of difficult diagnosis by the layman, it is of great importance to select a healthy specimen. Such a one can be had of several reliable manufacturers, but is not the lowest in first cost, and, in absence of definite information, it is generally safest to avoid a very cheap machine. Even the best manufacturers make motors with different ratings as to speed and heating limits, and my advice is to select the motor with lowest speed and lowest heating limit; this latter should not exceed 40 degrees C. rise above external temperature, at continuous full load run. The speed should be the so-called "slow-speed" variety; Table No. 2 gives about the proper speed for each of the standard sizes of shunt motors. This table also gives the approximate selling prices of the list, based upon the highest grade machines. Price includes motor with pulley, base-frame and belt tightener, also automatic starting box.

A corresponding list of "medium speed" motors may be obtained, the speed for a given power being about 50 per cent higher than given in table; the prices being about 20 per cent less on smaller and 35 per cent less on larger sizes.

TABLE NO. 2—SPEED AND PRICES OF SLOW SPEED MULTIPOLAR MOTORS.

Rated Output H. P.	Speed R. P. M.	Price.	Price Per H. P.
1	1300	\$88	88
2	1200	135	67
3½	1050	190	55
5	950	240	48
7½	850	310	41
10	750	400	40
15	650	500	33
20	600	600	30
30	575	875	29
40	575	1040	26
50	550	1200	24

**Alternating Current Motors.**—In the paragraphs devoted to a description of alternating apparatus, I have called attention to the superior features of the induction type of 3-phase motor, and would recommend the selection of this type for an alternating distribution plant.

As this motor has no electrical connections from the lines to the armature, it may properly be of the enclosed style, with provision for ventilation. The working pressure should be 220 volts, and the current of 7200 alternations.

These motors have somewhat higher speed than the direct type and are somewhat higher in price, but their adaptability to railway shop use is unquestionable, and they are quite certain to come into extensive use.

#### WIRING AND INSTALLATION.

This part of the subject is so well covered by printed rules issued by insurance authorities and the electrical societies that it is hardly necessary for me to more than call attention to these rules and regulations, and to emphasize the importance of being guided by them.

It is in the wiring that the fire risk in an electrical system lies, and the boards of fire underwriters are very particular in seeing that wiring work is properly done, as a protection to the companies issuing policies. An inspection certificate from the experts of the board is, therefore, desirable as a protection against bad work done by contractors, and as evidence in case of fire.

A specification here of the kinds of material to be used or the manner of running circuits, would lead into too much detail for a paper of this kind. It may be briefly said that wires should be run, where possible, in positions where they are always exposed to view; material should be of the best, and the work made a neat and mechanical job, not a complicated jumble of "temporary lines" (which are seldom removed, by the way), strung in a manner to be easily torn from their fastenings.

All wires must, of course, be insulated with rubber or with braided material impregnated with tar compounds, according to the situation, the voltage and the requirements of insurance rules; and must be mounted on porcelain or glass insulators out of contact with all wood, iron or brickwork of the building.

The different sizes or carrying capacities of wires at the various points in a system must be carefully calculated, which can be done by very simple rules, and no considerable changes in location of motors or lights should be permitted without figuring its effect upon the distributing system.

The size of the wires is determined by two main considerations: First, their safe heating limit, and second, loss of power entailed by the heating. The heating limit for a given size of wire may be found in any book upon wiring calculations, and generally in the code of regulations published by the various boards of fire underwriters. The permissible drop of pressure, or loss, within the limits of heating effect, is a matter

to be determined by the individual; if very large, the waste at the coal pile is great, but the investment in copper conductors is small, and vice versa. An excessive drop, however, interferes with uniformity of pressure in various parts of the distributing system, so that it is seldom customary to allow more than 10 per cent drop from the generator to the motor, which means that 10 per cent of the current generated is lost in heat in the distributing system.

**Direct and Alternating Wiring.**—Distribution for these two systems is quite similar, differing only in the following particulars. The direct system requires but two wires for each line; the alternating requires more, thus the two-phase current needs four wires, and the three-phase, three. An alternating system, moreover, is of high potential, requires "converters," as before explained. These are contained in sealed iron boxes and are inserted in the lines at various places, according to local conditions.

#### ELECTRIC DISTRIBUTION AT THE BALDWIN LOCOMOTIVE WORKS.

As an example of the practical character of electric distribution of shop power, I am permitted to refer to the plant at the Baldwin Locomotive Works. The progressive spirit of the owners of these works is nowhere better exemplified than in the manner in which they have reconstructed their extensive plant during the past few years to take advantage of the most modern methods in handling material and utilize to the utmost the earning capacity of tools within restricted areas. So admirably have the details of their equipment been worked out that the limitations of handling the heaviest and most bulky of shop product in areas available in the heart of a large city, are hardly felt. It is not too much to say that their manufacturing methods to-day hinge largely upon changes made possible by the use of electric power, and that no other agency could be substituted wholly therefor except at incomparably greater expense in installation and maintenance.

In making this statement, I am well aware that handling machines, such as traveling cranes, can be and are often operated by other means than electricity; but their practicability hinges upon the provision of overhead spaces free from obstruction of line shafting, belting and supporting columns; the machine tools underneath must, therefore, be driven by line shafting and belting below the floor, which is a clumsy and generally impracticable method, or else by individual electric motor driving. In the Baldwin works, many of the most beautiful examples of traveling crane economy are found in the heavy tool shops—the wheel and the frame shops, for example—where motor driven tools have cleared the spaces for the cranes to work in. It is not, therefore, too much to say that electricity has been the key to the situation in these shops.

**History of the Electric Plant.**—For much of the following information I am indebted to the kindness of Mr. E. B. Halsey, of the Baldwin works.

Electric power was first introduced in 1890, when the new erecting shop was built, and was installed especially for the purpose of driving two 100-ton capacity cranes; these are of 75 foot span and cover, in two aisles, the entire area of the shop, 150x350 feet. They are each run by a 50 horse-power motor, belted to the driving clutches. An immediate saving of 80 men in the laboring force was effected, due increased facilities afforded by these cranes. The possibility of this result will be seen when we consider that one of these cranes is capable of lifting an entire locomotive, as well as the component parts of the same, thus allowing the various operations of erection to be carried on without mutual interference in the least possible space, and avoiding entirely the immense manual labor connected with the lifting of heavy parts, and delays consequent thereto.

A number of portable electric drilling outfits were also introduced in this shop, with a corresponding reduction in hand drilling work.

The next shop taken was the remodeling of the wheel shop. This had been driven by the ordinary method of line shafting and work handled at the lathes, etc., by hand jib cranes. This necessitated a heavy roof and precluded the effective use of overhead lighting, on account of the mass of timbers, shafting, pulleys, belting, etc. The shop was, consequently, very dark and much space was wasted in two long main aisles the entire length of shop, for handling the work in and out of machines. The laboring force amounted to about 40 men, and it required six men and 30 to 40 minutes time to unload and reload the large wheel lathes.

In the new shop, occupying the same area, electricity was used for driving, each machine having its individual motor; a traveling crane was erected, spanning the entire floor; about one-third more machines were installed, and skylights were introduced in the roof trusses, thus making the shop one of the lightest and most cheerful possible.

The handling by crane enabled a reduction in laboring force to about one-tenth of that previously required—from 40 down to four or six men; two men suffice to operate the crane, one at the levers and one at the hook. Moreover, a machine can now be unloaded and reloaded in five minutes with ease, largely economizing the time of the workman and increasing the capacity of the tool. A considerable reduction in power

requirements has also followed the introduction of electricity in this one shop; the shafting method required 150 horse-power at the engine, whereas there is seldom registered now more than 80 horse-power at the switchboard, notwithstanding the addition of the crane and many more machines.

Similar results have followed the introduction of electric driving in their frame shops, which constitutes really an extraordinary example of the ingenious application of elastic distribution of bulky material to be handled and worked in restricted space with very low headroom. By application of individual motors to the tools, the headroom was cleared for three short, spare, compactly built traveling cranes, which operate successfully in a vertical space thought entirely insufficient until seen. The shop has thus been converted into a handily arranged and light one, and the laboring force reduced 50 per cent over old practice.

In the new boiler shop electric driving has effected similar economies in time, space and cost; all tools are here driven by individual motors, and all plate and boiler handling done by electric cranes. The same remarks apply to the new tank shop; this shop is located nearly one-half miles from the power house, which would have necessitated a separate boiler and engine plant had steam driving been used.

Lest the foregoing may be cited as illustrating the benefits of the use of traveling cranes, and not of electric power transmission, I may say that in every case, except that of the erecting shop, the use of the crane was made possible only by electric driving of the tools served by it; and, moreover, in no case, except that of this same shop, is it possible to drive the cranes themselves by any other method.

Extent of the Plant.—The works have now installed 215 motors, rated from two to 50 horse-power each, and averaging 9 horse-power each for the entire number. The aggregate horse-power in motors is, therefore, 1930.

The total generator capacity installed is 700 horse-power, and the daily average horse-power at the switchboard is about 570, which is fairly constant throughout the day.

Power Required by Tools.—Table No. 3 is appended, giving a partial list of the kinds of machines operated by individual motors, with the amounts of electric power supplied the motors under different conditions of operation.

Repairs.—The force of workmen needed to keep up all line repairs, inspecting and repairs on the 215 motors, and on ten arc dynamos and four generators, consists of two men, with one-third of the time of another. One of these men alone keeps up repairs on armatures. The labor cost will thus average \$6 per day, and the new material consumed in repairs is estimated to cost about \$2 per day. The total labor and material cost per year is therefore about \$2500, or about 4 per cent on the first cost of the plant. Expressed in another way, it has been estimated roughly that the reduction in amount paid out for new belting and belting repairs since the introduction of electric driving, is sufficient to pay for maintenance of the motors.

Manner of Connecting Motors.—A word may be said regarding the practice at these works. Group-driving is employed for small tools, by belting from a motor to

Details are, of course, modified in carrying out the scheme, but in general the method consists in belted rather than geared motor attachment.

Reliability.—Two facts will be sufficient testimony that in this important quality electric distribution of shop power is satisfactory; they are: first, the small repair account above cited, and, second, the fact that the electric plant in these works is being constantly extended.

Conclusion.—The main object had in mind in writing this paper was to furnish our club members with a basis for a full discussion and an interchange of data upon the subject of electric distribution of railway shop power in its broad application as a means for increasing shop efficiency. If, therefore, my somewhat disjointed skimming over the subject should serve to acquaint members with the importance of investigation into it, I shall feel that the attention of the club has not been asked for an unworthy purpose.

SPECIFICATIONS FOR AIR BRAKE HOSE.

At the last meeting of the Central Railway Club the important topic of "Specifications for Air Brake Hose" was reported upon by a committee, consisting of E. D. Bronner and J. A. Bradley. This committee attempted no original investigations, but obtained a number of specifications issued by rubber companies and railway companies. It gave thorough study to these in the light of the experience that its members had had, and in its report after presenting the various specifications, submitted the following general propositions:

The requirements of an air brake hose are well known. They must form a flexible connection between the train pipes of the cars in a train, and are subject to a varying internal air pressure up to a known limit. They are constantly exposed to the elements, and when in use, are being continually vibrated or swung, and sometimes kinked.

Cars are sometimes parted without uncoupling the hose by hand, and an unusual and severe strain is put upon them, which in the case of a weak hose, is apt to destroy them.

In devising a specification and tests under which to purchase hose to meet these requirements, the following are some points which must be met:—

1. Strength to withstand the internal pressure and to resist the pulling strains sometimes put upon the hose.
2. Flexibility to permit constant variations from any fixed line through the length of the hose, as required by its functions, with the least deterioration of the material and to resist the effects of more or less kinking, as long as possible.
3. Quality and manipulation of the material to insure a strong and elastic tube, and the thorough vulcanizing of the tube to the fabric and the different layers of the fabric to each other, so that the component parts of the wall of the hose are strongly, yet elastically united as a whole.
4. Protection of the material comprising the hose from the action of the elements.
5. Dimensions to meet the requirements of the purpose for which the hose is intended, and to permit of the proper application of necessary fittings with the least chance of injury to the hose.
6. Proper permanent labels for the purpose of keeping desired records.

In the specifications shown these considerations have been met in various ways.

The bursting test of air brake hose has been placed at 500 to 650 lbs. per square inch; the proof pressure test at 300 lbs. per square inch. The strength is also insured by fixing the weight and quality of the fabric the number of wrapping, and the quality of the tube and friction.

Where the latter method is used there seems to be no great variation in the requirements for the fabric, but where some specify not less than four plies of fabric, others call for from two to three. On account of the various methods of building up a hose some range should probably be allowed. Where the fabric is composed of woven seamless material vulcanized to perfect tubes, two plies would appear to be sufficient. The specifications that call for not less than four plies would eliminate this type of hose from competition.

For a wound hose four plies are probably about the maximum limit that would produce the soft and flexible hose, with the quality of fabric specified. With the friction called for it will probably afford sufficient strength. Air hose have been made with as many as nine wrappings but this entailed a thin, finely woven fabric, which could not be frictioned properly, and produced a stiff hard hose.

The flexibility of a hose is certainly put to a severe test by the vibratory testing machine. It is also insured by fixing the quality and weave of the fabric, and the quality and elasticity of the gum in the tube and between the layers of the fabric.

By getting the proper quality of gum in the tube, and between the layers, which quality can be demonstrated in the case of the tubing by the stretching test,

solidity of the walls is insured with sufficient elasticity, as it permits of thorough vulcanizing of the gum to the fabric. A slight injury or defect in the tube will therefore not be so disastrous, as the air cannot so easily separate the tube from the fabric and the layers from each other.

The method employed for the protection of the hose materials from the elements, is to call for a perfect outer covering of gum of the same quality as the tube with capped ends vulcanized on.

In the inside diameters there seem to be some variations. The question is, for, say a nominal 1 1/4 inch hose, should the hose be accepted as small as 1 1/8 inch, or should it be enlarged within limits for ease and safety in applying fittings? Should also this enlargement be carried throughout the length of the hose or should it be confined to a short distance on the ends?

All the labels specified seem to furnish necessary records.

We have some samples of hose made by manufacturers who are unknown. A few minutes will make it clear that an immense variation exists in the different samples. Some will meet the tests, and much more, some apparently have no friction whatever. These samples cannot all be the best for the purpose.

A hose under some of the foregoing specifications may probably cost somewhat more than some of the samples exhibited. It is certainly a better hose for the purpose when purchased. One of the questions that should be brought out in the discussion, should be whether or not the nature of the rubber material is such that it will retain the qualities demanded by the specifications, for a sufficient length of time to extend the life of the hose much beyond the life of the cheap hose now so largely used?

Another point for discussion might be the best inside diameter of hose.

What is the best outside covering of the hose? should also be considered.

CAR INSPECTION—PAST, PRESENT AND FUTURE.

At the last meeting of the St. Louis Railway Club a paper on car inspection, past, present and future, was presented by Mr. Charles Waughop, chief joint inspector at St. Louis. Mr. Waughop made some amusing comments and advanced some interesting suggestions upon the general subject of car inspection, as will be seen by the extracts from his paper which we append:

I will make this paper as brief as possible, and touch lightly only on personal observations of car inspection during the past twenty-four years, making a few remarks on Master Car Builders and their rules of interchange. In 1874 there were very few car inspectors (technically speaking) in this country, especially in the smaller cities. A car inspector of that date, and for several years subsequent, had various duties to perform other than inspection of cars. They were supposed to assist in car repairing, oiling and other duties pertaining to the physical condition of the cars. This is still the custom at interchange points where the interchange of cars is not large enough to require the entire services of the inspector for inspection alone. Freight car inspection during this time and some years afterward was more for safety than at any time since.

The Master Car Builders' Association prepared a code of interchange rules—I think in December, 1876—which were adopted by the association at the meeting in June, 1877. These first interchange rules were few in number, were little understood by the inspectors in general, and very little attention was paid to their meaning. However, these rules were the beginning of rigid inspection. Here I wish to remark that the framers of the M. C. B. Code of Rules, from their first issue to their last, have manifested a tendency toward biblical matters, as their interchange rules have always been, more or less, written in parables, subject to different interpretations by different inspectors, as well as by the Master Car Builders themselves.

It seems to me the subject of plain and unequivocal language for interchange rules should be given much thought and the rules written plain enough for all classes of car inspectors to understand them alike. They seem to have overlooked the fact that car inspectors, as a rule, are not college-bred men. You can't hire brains for \$45.00 per month and expect a man with them to give satisfaction as a car inspector.

Each year since 1877 the Master Car Builders' rules have been revised more or less, new conditions arising and general advancement making it necessary. They have been educators in several lines, especially in the universal use of terms for the different parts of a car. Some years ago it was customary for inspectors in the East to call a draw-bar a "bull-nose" or a "bull-head," and in the South they referred to draft timbers as "pull sticks," and in the same locality they oftentimes used the terms "brake noecasin" and "brake slipper" for brake shoe. Several years ago we removed from a car coming from some Southern road an M. C. B. de-

Tool.	Kind of Work.	Cut.	H.P. Required.			No. of Cutters.
			Empty.	Light Load.	Full Load.	
70" Wheel Lathe	Wheel Center.	Light.	4.4	7.9	1	1
	32" Wheel Center.	1/2" De'p	4.7	5.8	1	
Horizontal Lathe	56" Wheel Center.	1/2" De'p	1.5	5.3	6.2	1
	Frames.	Heavy.	2.3	4.3	7.1	
Large Double Frame Planer	2 Frames.	1/2" De'p	11	..	21.6	2
	Wrought iron 6" thick.	.....	1.5	2.1	6.5	
Slotter 12" Str'ke	Frames.	.....	3.4	4.2	7.4	1
	Frames.	.....	3.4	..	11.3	
36" Planer.....	1" Drill Wrought iron.	.....	.97	1.94	2.9	1
	1 1/2" Drill.	.....	.97	1.92	2.2	
Drill Press.....	2 1/2" Drill.	.....	.97	1.94	2.85	1
	9-16" Plate Steel.	.....	3.5	6	19	
Boiler Pl. Shears	Steel Plate 11-16" thick x 10' 6".	.....	4.5	14.4	19.8	1
Boiler Pl. Rolls	Long in Shears.	.....	4.5	14.4	19.8	1

a line shaft. Individual driving is used for large and for isolated tools, or where cranes make shaft-driving inconvenient. The attachment method in latter cases is somewhat peculiar and may at first sight strike one as a makeshift; a knowledge of electric machinery will, however, convince an observer that there is good, practical, mechanical sense in it. It consists in supporting the motor upon a light iron framework bolted to the machine, this same framework serving as support for the cone-pulley countershaft. The motor is then belted to the countershaft, and the latter to the machine, as usual. This arrangement allows of variable speed with belted connection to the motor, without electrical complications of variable speed motors, and an elastic connection between the motor and the cutting tool.

fect card, which called for "one conductor's cock gone and plugged up." On examining the car we found one angle cock gone and end of train pipe plugged with a wooden plug. We also had a card from the Southeast calling for "one up-and-down bolt in pull stick broken," by which the inspector meant one (1) draft bolt broken.

I inspected a car several years ago in the Vandalia Line yards at East St. Louis which bore an M. C. B. defect card issued by an Illinois Central Railroad inspector at Effingham, Ill., which read, "One draft timber broke dam night in two," and it was. This difference in the terms used for the different parts of a car in the different sections of the country is at present almost eliminated, thanks to the M. C. B. rules.

Advancing to 1881, we find the M. C. B. rules more rigid and the inspection likewise rigid. It was difficult to pass a car in interchange without pasting it with M. C. B. defect cards. Upon my advent as Joint Car Inspector at East St. Louis in 1881, I found that the rules had educated the inspectors up to the Chicago idea of the Golden Rule, i. e., "Do that fellow or he'll do you." I came from Chicago.

At that time the St. Louis Bridge and Tunnel Railroad was handling less than five hundred cars per day, yet, owing to the manner of inspection, it required the services of a locomotive and crew and a switching crew of three men, who were kept busy setting out and returning cars to the various lines on account of trivial defects. This manner of handling bad-order cars was speedily changed by joint inspection. The difference of inspection in 1881 and the present time can be better understood when we know that during the months of January and February, 1898, there were interchanged at St. Louis and East St. Louis (loaded and empty) upward of 500,000 cars, and not one loaded car during this period was returned to the delivering line on account of defective condition of the car. We believe the transportation departments appreciate this—at any rate they should—for it means at least forty-eight hours' delay to any car returned to a delivering line on account of repairs necessary, to say nothing of the expense of handling the car.

Car inspectors of the present day, to be classed as good ones, should have a good grammar school education, be reasonably good penmen, thoroughly understand all parts of cars and be familiar with their weak parts, and, above all, have good judgment and strictly abstain from drinking intoxicants of any kind.

As to the future of car inspection, it would be something like predicting what the verdict of a petit jury in a railroad damage suit would be with the evidence strongly in favor of the railroad. Being in the joint inspection service and knowing its benefits to both the transportation and car departments, I would recommend joint service at all interchange points where the interchange requires more than one man. It certainly would reduce disputes and delays of freight to the minimum, besides being an economical move.

I will close this paper by calling attention to one of the most extravagant features of railroading—that is, the nonadoption by the Master Car Builders of standards for the different parts of cars. Personally, I can see no tenable reason why, in this age of steel, we should not have one standard truck for all cars of equal capacity; or, if one is not enough, have two or three. Take for a basis a truck of the \* \* \* pressed steel type for one design, a diamond frame truck with a steel bolster for another, etc. The same rule would apply to couplers. Say they adopt five different patterns of the \* \* \* type—one would be better—and drop the other fifty-one different kinds on the market. The same idea could be applied with equal advantage on the other parts of the car, such as air brakes, body bolsters, etc., etc.

Did it ever occur to you that it costs something like (approximately) \$3,000,000 per year for inspection of cars for wrong repairs alone? I believe this is a safe estimate; and did it occur to you that this money could be saved if all cars were standard? Look at the millions of dollars lost on delay to cars in one year on account of holding cars on repair track out of service until proper material can be obtained from the owners of car, many miles away, to put the car in serviceable condition, which material would have been in stock if all cars were of the same standard. How many millions of dollars have all railroads in North America invested in material for foreign cars, at hundreds of different repair tracks, anticipating a break? If cars were standard, I believe it safe to say that the railroads could do the business of this country with 300,000 less cars than they now have.

The car manufacturers would also be in a position to save a few millions of dollars in the reduction of prices for new cars. This they could readily do, when it is considered that if a standard was adopted it would be unnecessary for the car manufacturing companies to carry so many different patterns, etc., etc., which are necessary when so many different kinds and sizes of cars are built, each company having its own and different design.

#### RECENT PAINT TESTS.

Some months ago we gave a brief account of certain paint tests with a record of the results noted to date. We are permitted now to give the completed record. These tests were made by a company which is seeking to find a suitable covering for metal in cars. For obvious reasons we are not permitted to use the name of the testing company nor of the makers of the various coverings tested.

In order to determine the protective quality of various paints on metal, the following tests were prosecuted by coating black iron pans with the material to be tested, filling same with a saturated solution of rock salt and water, specific gravity 1.130, and exposing to the elements; the solution being maintained continuously at varying depths, owing to rain and evaporation, until it became entirely evaporated, when it was not replenished. November 13, 1897, the pans were carefully examined; after which, pans 6, 7 and 9 were re-coated with same material as previously, and all refilled with the solution and again exposed to the elements, December 4, 1897. Since that date additional pans have been coated and added to the test. On April 18 final examination was made of all pans' exposed, of which the following is a report:

No. 1. Two coats carburet black—Exposed, 9-25-97; examined 11-13-97; time exposed, 50 days. Condition: Fair; showing very little evidence of corrosion.

The same (No. 1).—Exposed, 12-4-97; examined, 4-18-98; time exposed, 185 days. Condition: Somewhat rusted; showing red rust around the edges of the top and inside; would not serve as a protective coating much longer; bottom badly covered with red rust on the outside.

No. 2. Two coats Fuller's earth and linseed oil made by the testing company—Exposed, 9-25-97; examined, 11-13-97; time exposed, 50 days. Condition: Very fair; equally as good as No. 1.

The same (No. 2).—Exposed, 12-4-97; examined, 4-18-98; time exposed, 185 days. Condition: Coating on the inside almost entirely loose on the sides and about the edges on the outside; paint entirely gone on the bottom on the outside; in fact, no protection at all to the meat. In nearly as good condition as No. 1.

No. 3. Two coats red lead and oil—Exposed, 9-25-97; examined, 11-13-97; time exposed, 50 days. Condition: Fair; giving evidence of peeling.

The same (No. 3).—Exposed, 12-4-97; examined, 4-18-98; time exposed, 185 days. Condition: Somewhat corroded on the inside and bottom of the outside; in not quite as good general condition as No. 1. Nearly so.

No. 4. Two coats mineral paint; one coat carburet black—Exposed, 9-25-97; examined, 11-13-97; time exposed, 50 days. Condition: Showing signs of corrosion; paint peeling.

The same (No. 4).—Exposed, 12-4-97; examined, 4-18-98; time exposed, 185 days. Condition: Badly corroded on the sides, inside, and bottom outside; small amount of the original coating left on the outside, except at the top edge; in nearly as good condition as No. 1 and 3, but much better than No. 2.

No. 5. One coat red lead in oil and one coat carburet black—Exposed, 9-25-97; examined, 11-13-97; time exposed, 50 days. Condition: Covering peeled off badly.

The same (No. 5).—Exposed, 11-4-97; examined, 4-18-98; time exposed, 185 days. Condition: Sides on the outside badly corroded; paint almost entirely peeled off; outside still covered some except at the edges. About the same condition as No. 2.

No. 6. Two coats of graphite paint prepared by a concern which manufactures graphite paints—Exposed, 9-25-97; examined 11-13-97; time exposed, 50 days. Condition: Covering had peeled off very badly, showing material did not adhere to metal.

The same (No. 6).—Recoated—Exposed, 11-4-97; examined, 4-18-97; time exposed, 135 days. Condition: In fair condition; inside just beginning to corrode and paint to peel a little; bottom well covered on the outside; edges of the outside corroding somewhat. In about as good general condition as No. 1.

No. 7. Two coats of asphalt paint prepared by an asphalt paint manufacturing company—Exposed, 9-25-97; examined, 11-13-97; time exposed, 50 days. Condition: Badly peeled and corroded.

The same (No. 7) recoated—Exposed, 11-4-97; examined, 4-18-98; time exposed, 135 days. Condition: Paint gone almost entirely off the inside and bottom of the outside; sides outside badly corroded; rust showing through. About the same general condition; a little worse, if anything, than No. 2.

No. 8. Two coats graphite made by the testing company—Exposed, 9-25-97; examined, 11-13-97; time exposed, 50 days. Condition: Good; few signs of corrosion or peeling.

The same (No. 8).—Exposed, 12-4-97; examined, 4-18-98; time exposed, 185 days. Condition: Sides on in-

side badly corroded; paint almost entirely peeled off; bottom of the outside same condition; sides outside badly corroded; paint started at the upper edges; about the same general condition as No. 2.

No. 9. Two coats white lead and oil and one coat carburet black—Exposed, 9-25-97; examined, 11-13-97; time exposed, 50 days. Condition: Entire covering peeled off and surface badly corroded.

The same (No. 9) recoated—Exposed, 12-4-97; examined, 4-18-98; time exposed, 135 days. Condition: Fair condition; outside well coated; paint adhering well, except at the top edges, where it is beginning to corrode somewhat. Inside in fair condition; paint starting to peel in three or four small places; in good general condition, even better than No. 1.

No. 10. Two coats of a special paint made by an eastern paint manufacturing concern—Exposed, 12-4-97; examined, 4-18-98; time exposed, 135 days. Condition: Sides inside paint peeling considerable and raised up in patches. Metal badly rusted through paint in many places; about the same general condition as No. 3; no better.

No. 12. Two coats mineral paint—Exposed, 12-4-97; examined, 4-18-98; time exposed, 135 days. Condition: Inside in good condition; only small amount of rust showing; paint adheres well; not starting to peel at all. Bottom outside badly rusted; paint nearly gone; edges on the outside, paint just commencing to peel. In a little better general condition than No. 3.

No. 13. Two coats of a special preparation made by a Chicago concern—Exposed, 1-13-98; examined, 4-18-98; time exposed, 95 days. Condition: Inner sides somewhat corroded through the paint; outside bottom paint entirely gone; metal badly corroded; outer sides, paint starting to leave; top sides badly rusted; about the same condition as No. 1. This material is claimed to have special preservative properties, one of the features being that it remains plastic to a certain extent and at no time will become thoroughly dry and hard. On examination it could not be determined whether material was plastic or not, as it was so badly rusted and peeled away.

No. 14. Two coats of black furnished by a Chicago company—Exposed, 1-13-98; examined, 4-18-98; time exposed, 95 days. Condition: Inside, paint almost entirely peeled off; metal quite badly corroded; outside same; paint adhering in small patches; metal corroded through the paint badly. About the same general condition as No. 2.

No. 15. Two coats special primer—Exposed, 1-13-98; examined, 4-18-98; time exposed, 95 days. Condition: Inside somewhat corroded; paint adhering very well; not showing blisters; outside metal badly corroded through the paint on the bottom and sides. About the same general condition as No. 3.

No. 16. Two coats graphite paint made by an eastern paint manufacturing company—Exposed, 1-13-98; examined, 4-18-98; time exposed, 95 days. Condition: Inside paint adhering very well, metal showing corrosion through the paint; bottom, paint entirely gone; metal corroded; sides, corrosion appearing at the edges; about the same general condition as No. 1. A little better if anything.

No. 17. Two coats grapho-oxide—Exposed, 1-13-98; examined, 4-18-98; time exposed, 95 days. Condition: Paint peeling considerably on inside in small patches; metal badly corroded; outside, paint almost entirely gone; badly rusted; about the same general condition as No. 4.

No. 18. Two coats of red lead and oil said by its western manufacturers to be of specially good quality and coating properties—Exposed, 1-13-98; examined, 4-18-98; time exposed, 95 days. Condition: Analysis shows pure red lead, 84.37%; litharge, 15.63%. The foreman of the testing company advises this red lead is the best material he has ever received. Inside paint starting to peel in blisters, some  $\frac{3}{4}$ " in dia. down to the water line. Paint adhering fairly well on the outside, except at the top edges, where it is commencing to peel; bottom badly rusted and paint gone on the bottom from the space where it has been resting. About as good general condition as No. 3.

No. 19. Two coats lampblack and oil—Exposed, 1-27-98; examined, 4-18-98; time exposed, 81 days. Condition: Paint almost entirely gone; metal corroded almost all over whole surface. Worse than No. 2.

No. 20. Two coats of a carbonizing coating—Exposed, 2-8-98; examined, 4-18-98; time exposed, 69 days. Condition: Inside somewhat corroded through paint; outside badly corroded on the bottom, very little paint being left; also corrosion quite extensive on the outside, specially near the top edges; sides badly rusted. About the same general condition as No. 1.

No. 21. Two coats of a special preparation used by the company furnishing it to coat steel shapes manufactured by them and used in car equipment—Exposed, 2-28-98; examined, 4-18-98; time exposed, 49 days. Condition: Corrosion showing quite extensively on the inside near the upper edges; beginning to show through in places on the bottom and sides, especially at the corners. A little better condition than No. 3.



THE HALEY BUMPING POST.

An interesting and very promising bumping post is that which is shown in our half-tone reproduction of a photographic view. This post—known as the Haley post—is all metal, the frames and plunger being made of semi-steel and the springs of the best quality of coil spring steel. There is absolutely no wood employed in its construction or in its fittings, and thus all trouble with rotting or splintering is entirely eliminated.

As the post is secured on a broad foundation, it cannot tip sideways or backwards, and, as it is fastened to the same rails that the end or bumping car rests on, it has this extra weight for an anchorage. The post will, as our engravings show, allow an engine to pass far enough between the frames to receive the impact on the pilot coupler. This blow is received on a plunger and is taken up by two double coil springs, thus reducing the shock on rolling stock to a minimum.

The expense and inconvenience of excavating is done away with, as the post is easily secured to the rails with very little labor, and, should occasion arise, can be quickly transferred from one track to another.

This post is made in two sizes, for passenger and freight service respectively, and as it is less unsightly than the wooden post ordinarily used in passenger stations, it is for this reason especially suitable for such service.

The Haley post has been carefully tested by some of the largest roads in the country, and is said to have given excellent satisfaction. It is offered by the King & Andrews Co., of Chicago, who are its sole makers.

STEEL FORGINGS.

At the close of an exhaustive paper on the topic "Fatigue of Metal in Wrought Iron and Steel Forgings," presented before the Franklin Institute, the author, Mr. H. F. J. Porter, sums up his views of steel forgings as follows:

Experience must teach the engineer what quality of steel is best suited for the various parts of his engines, and his judgment must determine whether he will use high quality and decrease the size of his forgings or a cheaper grade and put in more metal and take greater risk.

Although forgings can be made to fill a large variety of specifications, they can, in general, be divided into six classes, as follows:

- (1) Mild steel, annealed.
- (2) Medium hard steel, annealed.
- (3) Medium hard steel, oil tempered.
- (4) Nickel-steel, annealed.
- (5) Nickel-steel, oil-tempered, No. 1.
- (6) Nickel-steel, oil-tempered, No. 2.

Each of these classes is supposed to cover a series of grades of steel, varying in strength several thousand pounds. In selecting the material for the forgings of an engine and in drawing up the specifications therefor, the premise should be omitted that "all forgings shall be made of open-hearth steel," and that "they shall be carefully annealed after forging."

Large shafts and similar forgings, crank and cross-head pins should be made of fluid-compressed steel, and should be hydraulic forged, not hammered. Wherever

practicable, an axial hole should be bored through shafts to insure absence of any internal defects. If forgings are oil-tempered, the hole can be made larger in diameter than if they are simply annealed, and where the bore is seven inches in diameter and above, they can be hollow forged on a mandrel. A hollow-forged, oil-tempered forging insures the highest attainable qualities, and can be especially recommended where the maximum strength with the greatest lightness is desired. Where it is important that the quality specified should be obtained in the more important parts, physical tests of the forgings as delivered should be demanded. For such tests prolongations should be left on the end of forgings for the purpose of having test speci-

mens cut from them after the forging and treatment have been completed. Such prolongations should re-

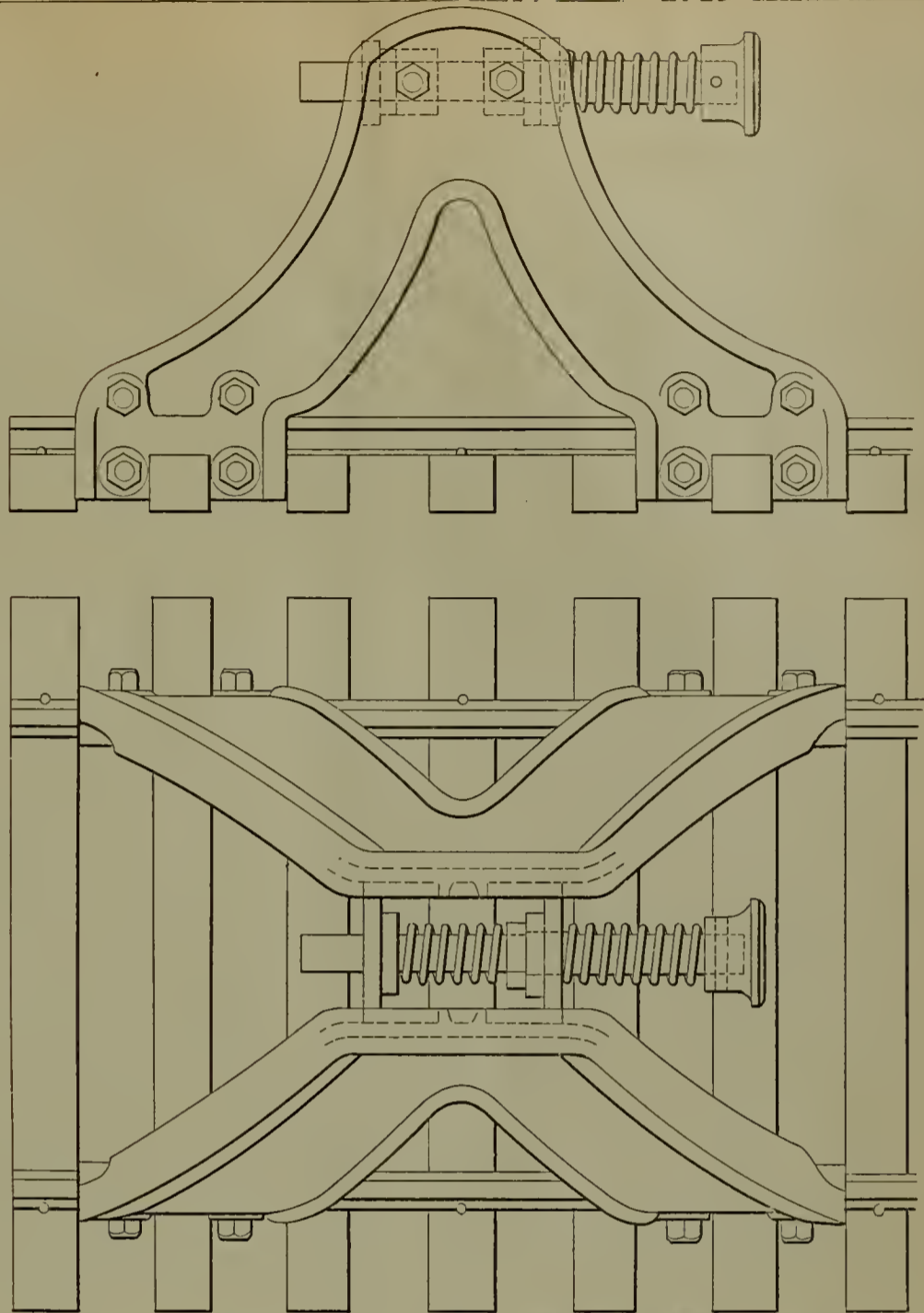

FIG. 2—THE HALEY BUMPING POST.



FIG. 1—THE HALEY BUMPING POST.

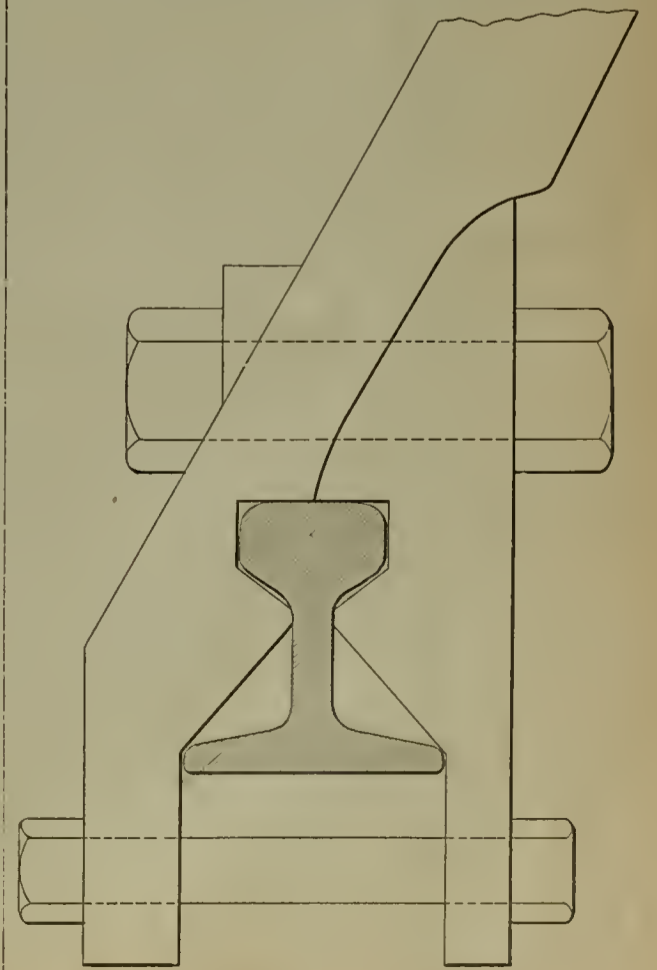

FIG. 3—THE HALEY BUMPING POST.

ceive no greater reduction than the forging at its largest part.

The following table shows the average physical qualities that should be obtained in forgings made of the several grades of steel mentioned, the test specimens being two inches long between measuring points and ½ inch in diameter and cut from full-sized prolongations of the forgings after treatment; the elastic limit being determined not by the drop of the beam, but by an electric micrometer:

	Tensile strength.	Extension per cent.	Contraction per cent.
Simple Steel.			
(1) Annealed	58,000	28.000	28 55
(2) Annealed	80,000	37.000	23 45
(3) Oil-tempered, with axial hole	80,000	45.000	25 50
Nickel Steel.			
(4) Annealed	80,000	45.000	23 45
(5) Oil-tempered, with axial hole	80,000	50.000	25 50
(6) Oil-tempered, with axial hole	90,000	61.000	22 50

I trust that I have been able to make plain in this paper that the causes of failure in forgings are in general to be found either in their design, quality of material or character of treatment in manufacture. Almost all forgings are subjected to alternating stresses. If they are composed of a quality of material which has a high elastic limit, properly proportioned, so that the stresses applied fall well below this limit, and if then they are free from flaws, defects and initial stresses, they should resist fatigue indefinitely.

### FIRE DAMAGE TO WRECKED CARS.

BY H. M. PERRY.

In settling claims between railway and insurance companies for fire damages, it is seldom that any difficulty is experienced, as the present value of a new car, less depreciation for age and the salvage on the scrap, is easily determined, and is the usual basis on which such claims are paid.

Occasionally, after a serious wreck, the whole train is destroyed by fire, when it becomes a difficult question to arrive at a satisfactory settlement, as all evidence of the extent of the damage due to the accident is destroyed by the fire.

In order to clear the tracks the iron work is loaded into cars and sent to the shops, and when the appraisers are called on to settle the matter they find a great mass of scrap iron as their only evidence of the wreck.

In an accident of this kind, in which a train was wrecked and afterwards completely destroyed by fire, the matter was placed in the hands of two experts for adjustment, one representing the railroad and the other the insurance company, and their method of arriving at the final conclusions was quite interesting.

As the fire had destroyed all evidence of the extent of the wreck, except such as shown by the damage to the iron work, it was decided to first make a thorough examination of the train crew and arrive, as far as possible, at the general condition of the train immediately following the accident.

This evidence was very conclusive and was substantiated by that of the wrecking crew as to the position of the trucks, truss rods, etc., after the fire.

From the information thus obtained, a sketch was made, showing the position of each car in the train and their probable condition before the fire started, and a thorough inspection of the scrap pile assisted in determining many doubtful points as to the force of the collision and value of the salvage.

A careful estimate was now made of the cost of a new car similar to the ones destroyed, and a proper amount deducted to cover depreciation due to age, which represented the value of the car before the accident.

Another estimate was then made, on each car separately, of the cost of repairs which would have been necessary to have put the car in the same condition as before the accident, and this amount was deducted from the depreciated value of the car, as accident damage, leaving the cash value of the car immediately before the fire.

The scrap pile was next carefully overhauled and all serviceable material such as castings, forgings, axles, brasses, and air brake material, which was not badly damaged, was credited to the cars from which it came and the remaining scrap weighed up and pro rated over the several cars.

The value of this salvage was deducted from that

of the cars immediately before the fire, and the remainder represented the net loss covered by the insurance.

### COMMUNICATIONS.

#### Chief Clerks and the Conventions.

St. Paul, Minn., April 14, 1898.

To the Editor of the Railway Master Mechanic:

I was pleased to see your editorial note in your April issue regarding chief clerks being encouraged to attend the M. C. B. convention.

For nearly two years I have been pounding away at the same idea and at the March meeting of the North Western Railway Club, the subject being recommendations for next year's M. C. B. rules, I succeeded in getting a resolution passed recommending that the committee of twenty-one engaged on the rules be more representative, i. e., three classes, viz: Heads of mechanical or car departments, men handling car repair accounts, and chief car inspectors.

John H. Goodyear.

Chief Clerk Master Mechanic's Office, C. G. W. Ry.

#### Locomotive Steam Gages Again.

New York, April 20, 1898.

To the Editor of the Railway Master Mechanic:

Mr. Theodore H. Curtis, in the current issue of your paper, goes to some trouble to indicate that having made certain statements in the truth of which there are at least kinks if not breaks, he intends to maintain them, though his own quotations from his February article and from mine of the following month refute him. It reminds me of a story told regarding a lawsuit over a stolen horse, and which story has perhaps drifted in his way. In the course of the suit a not over-particular witness who had caught it on the fly somewhere that horses are measured in so many "somethings or other" in the way of a human anatomical term, said that the horse in question was sixteen feet (!) high. Upon a very justifiable exception being taken to such a declaration in suggesting that "hands," not "feet," was meant, he claimed that he had said "hands." Being convinced of the contrary he retorted, "Well, if I said feet I meant it; he was sixteen feet high."

It is a source of satisfaction, as crediting human nature in general, to learn from his last article that Mr. Curtis was up to the time of its writing still possessed of that humility of spirit which will ever, if he cherish and protect it, be his guardian angel against a too positive or unqualified expression. For proof of this tender companionship see the last sentence of the first paragraph. In it, in a clean, open-hearted way, he admits that his "Notes on Locomotive Steam Gages" was of a construction to compel other than intended notice, for he says that in my March communication I point to "misuse of mechanical terms" and to "glaring contradictions." Logically, then, "misuse" and "contradictions" must exist in his "Notes, etc.," else how could I point to them? "Open confession is good for the soul;" and there is always some hope for a man who will even imply acknowledgment of the error of his ways when it is shown to him; and I always admire a man who has the moral courage to retreat when a friendly hand points out to him the falsity of his progress.

In the same paragraph he further says that I have put a very narrow construction on the term "Boiler-head" as applied to locomotive engines. It seems to me that any construction, no matter how broad, must appear narrow when compared with such a magnanimous interpretation as is given to it by Mr. Curtis, i. e.: "All that part of the locomotive boiler to which the steam fittings are applied." If the definition given by Mr. Curtis were correct, what kind of a boiler-head would a "Wootten" type of locomotive have? As to the narrowness of construction said to have been placed by me on the term "boiler-head," I can safely add that if it be at all narrow it is nevertheless amply wide to afford me sufficient foothold to maintain my position on it supported as I am by the opinion held by representatives of the most eminent locomotive designers and superintendents of motive power in this country; men doubtless thoroughly well known to Mr. Curtis by name, and quite likely in person as well, which latter I hope is for his sake the case.

It is always commendable to so write that the class of readers for which it is meant will understand it, but it is utterly indefensible to so write as to mislead in information, or encourage in laxity of definition of terms, the very ones whom it is sought to benefit.

If Mr. Curtis will keep in mind the results of my test of the influence of heat on a steam gage, showing that 7½ pounds was the maximum error reached for 223 degrees Fah., as opposed to its correct reading at a temperature of 64 degrees, I feel that his generosity will prompt him to admit the justice of my question as to why he stopped at the mere statement that a steam gage can be so placed on a locomotive as to show an error in its reading of over 20 pounds, and not continue

with an explanation of how it could be so placed. I asked the question in sincerity.

Paraphrasing my language as to "hair-splitting" Mr. Curtis says that "when the hair grows as large as 7½ pounds in 143 degrees rise of temperature, it justifies splitting." I ask Mr. Curtis to turn again to my March letter, and this time read and grasp correctly, and he will see that the "hair-splitting stunt" applies solely to the alleged departure from truthful reading of a steam gage, correct at 60 degrees Fah., placed in a temperature of 100 degrees Fah. It was the "100 degrees" with which I plainly dealt, and not the "or more" degrees. My two tests showed me that a gage taken from a temperature of about 62 degrees and exposed in gradual rise to one of a 100 degrees, did not show any readable error, nor did I suppose that it would.

I entirely agree with him that the words "or more" fully dispel any thought of "hair-splitting," and it is because of my entire agreement with him—proven by unhesitatingly making public figures which are in accord with his statement—that I confined myself to his comparison between 60 degrees and 100 degrees; the point being that he used "100 degrees" at all. The simple fact that he used the words "or more" does not dodge the aptness of my use of the term "hair-splitting." I having applied it to a rise of 40 degrees, with 60 degrees as a base. "Or more" forms a most convenient and extensive field for the exercise of an assertion when there is any risk of collision, which perhaps Mr. Curtis thought there was, hence his retreat to where he had plenty of elbow room.

Concerning Mr. Curtis' gratuitous misapplication of my citation concerning an unusually long water column, it suggests itself to me to say that it is a convenient trick for the ends of self interest to extract a part of another's writing and then weave about it a personally satisfactory answer, to the other's intended confusion in the eyes of those who have not read the original. When a man wanders so far into the domain of irrelevancy as to even remotely apply to locomotive practice my instance of a "two-story" water column, it argues either a wilful misinterpretation of what he reads or an inability to understand plain English. If Mr. Curtis will be good enough to accept the very plain meaning of what I wrote, he will see that I was careful to recognize that his "notes" referred specially to locomotives and that I quoted from that particular part of his communication only to introduce, while on the subject of steam gages, an item of perhaps general engineering interest in the way of an ultra-long water column.

Finally as to the last paragraph of his February article, which seems to be the main cause of difference of view between him and me. Mr. Curtis says in his rejoinder that in the paragraph in question he wrote that the steam gage should always be connected direct to the boiler. So he did, and so it should; nor did I say anything to the contrary. He then says in continuation that the rest of the paragraph deals with the "steam gage connection connected to the fountain." For the better understanding of both sides, I will, if permitted, give the paragraph in question verbatim as it appears in my copy of the Railway Master Mechanic, as follows.

"The steam gage pipe should always be connected direct to the boiler. If it be connected to the boiler-head fountain, the steam turret, or any device that has a number of boiler-head fittings attached, it will be governed by the pressure in this fountain. When both injectors are working, they taking steam from the fountain, there will be several pounds pressure less in the fountain than in the boiler. This may be detected by noting the boiler pressure (italics are mine) when both injectors are working, and then shutting off both injectors at once and noting the instantaneous rise of pressure by the gage indication. While the boiler pressure may rise after shutting off both injectors, it rises gradually and not instantaneously."

Does Mr. Curtis wish it to be inferred that it is a usual arrangement to have two steam gages in a locomotive cab, one connected to the boiler direct and one to the fountain? If he does not, then in all fairness let me ask him how—inasmuch as he says that all of the last paragraph of his "Notes" deals with gage connection to fountain—the boiler pressure can be noted from the reading of a gage so connected and when with both injectors working, there will be "several pounds less pressure in the fountain than in the boiler?" Mr. Curtis previously and correctly said that such a gage would be governed by the pressure in the fountain, and as he certainly would not consistently have the boiler pressure noted from a fountain connected gage it implies the connection of the gage to the boiler and not to the fountain, and the "instantaneous rise of pressure" is thus referred to the boiler! Experience denies any such instantaneous rise of pressure in a boiler. Mr. Curtis himself recognizes this in the last sentence of his "Notes," and therefore it follows indisputably that either this sentence contradicts the one

immediately preceding it, or the paragraph is an example of involved diction, and that I am so ignorant of the meaning of the word "contradiction" as he imputes my being concerning the term "boiler-head" of a locomotive.

I must say that I feel the article on steam gages to embody latent truth; but I fear that your correspondent has an unfortunate manner of expressing himself which is far more pernicious than if it came from an ignorant man, which he is not.

Wm. F. Monaghan, M. E.,  
Member American Loc. Mech. Engrs.

BOOK NOTES.

The Sargent Co., of Chicago, is just issuing a set of maps, showing the West India Islands as a group, the Island of Cuba in particular, and the world, showing the relative positions of various countries. These maps are printed in several colors, and are very timely and interesting. The Sargent Co. will be glad to send them to railroad men or to users of steel castings upon application.

It is interesting to follow in the history of Christianity the personification of the war spirit, which is so foreign to Christian theoretical teachings. This history has been briefly traced by Dr. Paul Carus in the April Open Court in an article entitled Belligerency in Christianity, which is adorned by many illustrations of the bellicose saints and legends taken from old engravings.

Appletons' Popular Science Monthly for May has an article on Snow Crystals, illustrated with a series of actual photographs taken by the aid of a microscope. The curious and beautiful crystal forms, accurately reproduced by the camera, give one a new interest in snowstorms.

Mr. Franklin B. Locke, a Massachusetts civil engineer, has written for the May number of The Century an article on "Railway Crossings in Europe and America." Mr. Locke tells of the methods that have been adopted in Europe to avoid grade-crossings, and of the efforts toward the abolition of these crossings in various parts of this country. He also compares the number of railway casualties in Europe and America. The article is profusely illustrated by Potthast, Pape, Fraser, and others, the pictures showing typical elevated, depressed, and grade crossings on both continents.

IMPROVED HEADING AND FORGING MACHINE.

An improved heading and forging machine has recently been turned out by the Acme Machinery Co., of Cleveland, O. The compact, solid appearance of this machine is indicated by the illustration given herewith.

The bed of this machine is made in the box form with three deep longitudinal trusses, strengthened by a transverse truss through the box, which distribution of metal gives great strength to the bed, and the bearing next to the fly-wheel is further strengthened with a steel tie-beam. The shaft is of the best forged iron, made with a clutch hub and two double

disc cranks for one solid forging, and is driven by a single wheel on machines up to 2 ft. and by gearing on machines above that size. The shaft is carried in three large bearings. The face of the bearings being inclined towards the front of the machine at an angle of 45 degrees brings the thrust of the forging tools against solid metal and relieves the main caps and cap-bolts from all strain. The clutch hub as a mortise in which is fitted a tool steel pin. This pin engages with the clutch by placing the foot on the treadle and is automatically disengaged when the foot is removed, so that when making special forgings one or more blows can be given as may be required to finish the work, or the machine may be run continuously by throwing in the treadle latch. The slides are provided with phosphor bronze ways and cast iron side gibs and run on hardened tool steel ways. The stationary die-block, movable die-block and toggle block and slide are steel castings. The toggles are hardened tool steel forgings. The dies and plungers are of novel construction and will turn out perfect work with few blows or strokes, so that square and hexagon head bolts are made in from two to three strokes, standard upsets at a single stroke and rivets at a single stroke right off the rod. The stock gage is also a new and valuable feature, remaining in front of the dies until they are entirely closed, and then moving out of the line of the heading tools with a smooth and easy motion.

The latest improvement in these machines is what is termed an "automatic relief and adjustable time device." This consists of a spring in the slide that moves the links that in turn move the gripping dies to the closed position. As the motion begins the spring has the least power, but as the motion continues the power increases, owing to the position of the links, until it is almost irresistible, ending with the dies in the closed position, and all centers in line, and when in that position of course nothing can release the grip. It will be seen at once that if the stock, being fed to the machine, should get caught in the dies, or if an accident happens such as a wrench falling between the dies, the spring will yield and the toggles will not lock or come to their centers, and thus the machine is relieved of undue strain. In addition to the office of the spring as a relief, it is also an adjustable time device. By time device is meant the time that the dies close and remain closed in relation to the advance of the heading plunger. For instance, if rivets and small pieces are being made it is necessary for the dies to remain closed an instant only. In making larger work, where it is desirable to gather more stock into the upset, the pitman that closes the dies may be lengthened by setting up the spring, means for doing this being provided, so that the spring will compress as the machine goes over the center and thus the dies will remain closed longer, the first eighth compression giving 1/2 in. more stock in the upset and the second eighth giving 3/4 in. more stock in the upset, and so on to the limit beyond which the material only folds into cold shuts. Thus it will be seen in addition to

the relief being automatic, the time that the dies shall remain closed is adjustable to suit conditions. This device has been thoroughly tried on the difficult jobs that long experience suggested as sure to try the machine to its limit, and has been found to meet all requirements in a most satisfactory manner. The parts in this machine are fewer in number, larger in their bearings and working surfaces, more convenient of access, less in the way in rapid operation and more self-contained than anything that the Acme Company has ever built in this line before. The entire construction of the machine is the best that special tools, skilled workmen, long experience and efficient superintendence can make it.

PERSONAL.

Mr. T. A. Kircher has been appointed assistant master mechanic at the Allegheny shops of the Pennsylvania.

Mr. J. M. Winslow has resigned as superintendent of motive power of the Washington & Columbia, and the position has been abolished.

Mr. W. C. Peterson has been appointed foreman of the shops of the Oregon Short Line at Pocatello, Idaho, in place of Mr. D. J. Malone, promoted.

Mr. George Fraser, formerly of Topeka, is now in charge of the Santa Fe Pacific blacksmith shop at Albuquerque in place of Alex Lindsey, resigned.

Mr. Frank Slater has been appointed master mechanic of the Chicago & Northwestern at Escanaba, Mich., succeeding John W. Clark, resigned.

The jurisdiction of Assistant Master Mechanic Hollingshead, of the Wabash, with headquarters at Ashley, has been extended over the car department.

Mr. W. C. Halfman has been appointed master mechanic of the Chicago & Southeastern, with headquarters at Lebanon, Ind., to succeed Mr. J. W. Roberts.

Mr. E. H. Harding has been appointed master mechanic of the Chattanooga Southern with office at Chattanooga, Tenn., succeeding J. H. McGill, resigned.

Mr. H. S. Montgomery has been appointed general storekeeper of the Lehigh Valley, with headquarters at South Bethlehem, Pa., vice Mr. C. P. Coleman, resigned.

Mr. W. F. Beardsley, master mechanic of the shops of the Pennsylvania lines at Allegheny, Pa., has had his jurisdiction extended over the Erie & Ashtabula division.

Mr. F. F. Hildreth has been appointed acting general foreman of the Terre Haute shop of the Terre Haute & Indianapolis, succeeding W. R. McKean, Jr., resigned.

Mr. Edward J. Wohrle has been appointed storekeeper of the Columbus, Sandusky & Hocking at Columbus, O., to succeed Mr. J. M. Fitzgerald, resigned to enter other service.

Mr. Fred Wing has been appointed general storekeeper of the Minneapolis & St. Louis, with headquarters at Minneapolis, Minn., to succeed Mr. A. H. Mings, who has resigned.

Mr. George Tozzer, assistant purchasing agent of the Cleveland, Cincinnati, Chicago & St. Louis, has been appointed purchasing agent of that system, to succeed A. M. Stimson, deceased.

Mr. J. W. Harkom, heretofore master mechanic of the eastern division of the Grand Trunk at Montreal, has been appointed assistant mechanical superintendent of the Canadian Pacific.

Mr. J. Ogilvie has been appointed superintendent of motive power of the Canada Atlantic, and will have charge of maintenance of motive power, reporting to the general superintendent.

Mr. G. W. Seidl has been appointed Master Mechanic of the Baltimore & Lehigh, with headquarters at Baltimore. The office of general foreman of locomotive repairs has been abolished.

Mr. F. B. Smith has had his title changed from master mechanic to general master mechanic of the New York, New Haven & Hartford. His headquarters remain at New Haven, Conn.

Mr. Chas. M. Dunlop has resigned as foreman of the machine shops of the Oregon Short Line, at Pocatello, Idaho, to accept the position of foreman of the shops of the Rio Grande Western, at Helper, Utah.

Mr. Joseph Longstreth, road foreman of engines on the Pocahontas division of the Norfolk & Western, has been appointed superintendent of machinery of the Schoen Pressed Steel Company, at Pittsburg, Pa.

Mr. C. H. Beggs, secretary to Vice-President and

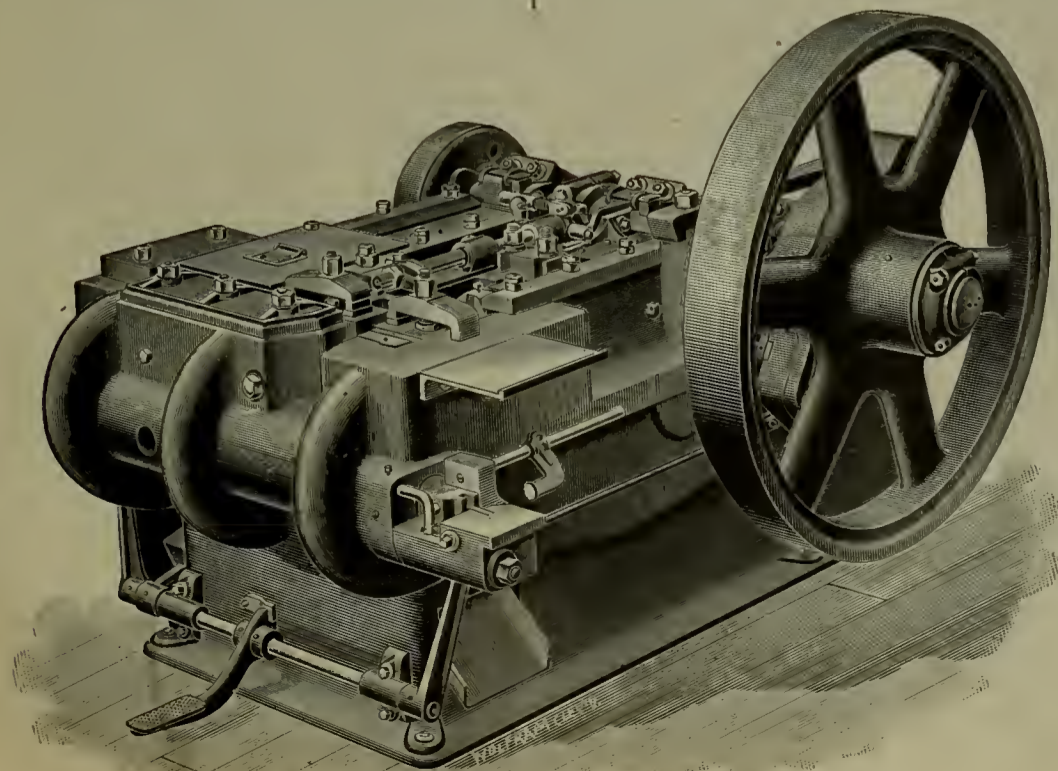

IMPROVED HEADING AND FORGING MACHINE.

General Manager B. F. Yoakum, of the St. Louis & San Francisco, has been appointed purchasing agent, in addition to his present duties, with office at St. Louis.

Mr. W. E. Widgeon has been appointed road foreman of engines for the Michigan division of the Terre Haute & Indianapolis, succeeding George H. Prescott, who has been appointed round house foreman at Logansport, Ind.

Mr. J. Van Dell, heretofore with the Chicago & Alton, has been appointed master car builder in charge of the Chicago shops of the Chicago, Rock Island & Pacific to succeed Mr. L. T. Canfield, resigned to enter private business.

Mr. Geo. Westinghouse has been elected an honorary member by the German Society of Locomotive Engineers, which has about 14,000 members. "as a recognition of his services to transportation by the invention of his railroad brake."

Mr. T. F. Underwood, of Emporia, Kas., heretofore foreman of the mechanical department of the Santa Fe Pacific in that city, has been promoted to the position of division master mechanic of the same road with headquarters at Williams, Ariz.

At the home of Mr. and Mrs. John Player, at Topeka, April 20, their daughter, Miss Kate E. Player, was married to Mr. Chas. B. Royal. Mr. Royal is a son of the late George Royal, and is master mechanic at Portsmouth, Va., of the Seaboard Air Line.

Mr. L. T. Canfield has resigned the position of master car builder, in charge of the Chicago shops of the Chicago, Rock Island & Pacific, to become the Chicago representative of the P. H. Murphy Manufacturing Company, of St. Louis, manufacturers of the American and Winslow car roofs.

The following changes are announced on the Central of New Jersey: "Mr. W. L. Hoffecker is appointed division master mechanic in charge of New Jersey Central division. Mr. J. G. Thomas is appointed division master mechanic in charge of Lehigh & Susquehanna division. The offices of assistant superintendents of motive power and equipment have been abolished."

Mr. B. N. Coffman, who for the past six months has been in the employ of the Railway List Co. as traveling representative, has left our service to enter that of the government. Mr. Coffman has been made an officer in the Tennessee volunteers, and is now in camp at Nashville, Tenn. The many friends that he has made in railway and railway supply circles since his connection with our publications will join us in wishing him God-speed in his patriotic mission.

Mr. Charles Coleman, general storekeeper of the Lehigh Valley, with office at Packertown, Pa., has resigned to accept the position of purchasing agent of the Bethlehem Iron Co., South Bethlehem, Pa. Mr. Coleman entered railroad service in the passenger department of the Lehigh Valley in 1881. From March, 1888, to February, 1891, he was Chemist and Engineer of Tests. From February, 1891, until April, 1892, he was assistant general superintendent of the Eastern division, and then became general storekeeper.

Mr. Walter Dawson, formerly for many years master mechanic of the Delaware, Lackawanna & Western, died in New York, April 12, at the age of 75 years. He was born in London, England, and from 1851 to 1865 was connected with the Hudson River Railroad, successively as locomotive engineer, machinist and master machinist. He was appointed master mechanic of the Delaware, Lackawanna & Western in October, 1867, and later was made general master mechanic of the same road, holding that position until 1886.

On the Grand Trunk Mr. Thomas McHattie, locomotive foreman at London, Ont., has been appointed acting master mechanic of the eastern division of that system, with headquarters at Montreal, in place of Mr. J. W. Harkom, master mechanic, resigned. Mr. A. A. Maver is appointed locomotive foreman at London, vice Mr. Thos. McHattie, promoted and Mr. W. Turnbull appointed repair shop foreman at Toronto, vice Mr. J. McGrath, who is appointed erecting shop foreman at Stratford, Ont., vice Mr. A. A. Maver, transferred.

The St. Louis Railway Club has elected the following officers for the ensuing year: President, Chas. B. Adams, superintendent car service Wabash Railroad, St. Louis; first vice-president, J. J. Baulch, general freight agent, Wiggins, Ferry Co., St. Louis; second vice-president, H. C. Barnard, assistant superintendent B. & O. S. W. Ry., Washington, Ind.; third vice-president, J. R. Groves, superintendent machinery St. L. & S. F. Railroad, Springfield, Mo.; treasurer S. G. Scarritt, vice-president Scarritt-Comstock Furniture Co. 412 N. 4th street, St. Louis; secretary, H. H. Roberts, 512 Commercial building, St. Louis. Members of the executive committee were also elected as follows: Geo. B. Leighton, president Los Angeles Terminal

Railway, St. Louis; F. A. Johann, railway supplies, 73 and 74 Laclède building, St. Louis.

Mr. G. R. Joughins, superintendent of motive power of the Norfolk & Southern Railroad, has been appointed mechanical superintendent of the government railways of Canada, the appointment taking effect May 1. Though connected with one of the smaller roads in this country, Mr. Joughins has made his influence felt in some of the most important matters that have come up for the consideration of the mechanical departments, and is to a considerable degree directly responsible for the present tendency toward the building of steel cars. It will be remembered that interest in this matter was revived by a paper presented by Mr. Joughins before the New York Railroad Club in January, 1894, since which date most of the work in this direction has been accomplished. He has been for several years an active member of the Master Car Builders' and Master Mechanics' Associations and has been a member of important committees in each—notably the committee of five of the Master Car Builders' Association on "Steel Car Underframing" and the standing committee of the Master Mechanics' Association on "The Apprentice Boy." Mr. Joughins is excellently equipped by natural ability and training for the duties of his new position.—Railway Age.

Mr. William G. Creamer died on April 22 at his home in Brooklyn, N. Y., at the age of 77 years. A generation ago Mr. Creamer was well known to railroad men of the United States. He had invented a train brake which had some of the elements of a continuous brake. It was actuated by a spring wound up by hand on each car, and in the emergency the engine runner could apply the brakes throughout the train by pulling a cord and releasing the springs. This brake was used on a good many passenger cars throughout the country for several years, but the most ignorant railroad man to-day will see how very far short it fell of answering the requirements of an efficient continuous brake. The success of an emergency application depended upon the faithfulness of several brakemen on each train, involving a certainty of frequent failures. Its historic failure at New Hamburg in 1871, when 21 persons lost their lives and a large number of others were injured, ended its use. Many years of Mr. Creamer's life were devoted to the propagation of theories of ventilation, which were not entirely unsuccessful, as applied to buildings, but which were entirely impracticable for passenger cars.—Railroad Gazette.

#### SUPPLY TRADE NOTES.

—The Robert W. Hunt Co. is inspecting the two locomotives and five locomotive boilers that the Richmond Locomotive Works are furnishing to the Chicago Great Western Railway.

—During the month of March, 1898, the Westinghouse Air Brake Company manufactured, sold and shipped from its works at Wilmerding, Pa., 16,628 sets of air brakes for freight cars.

—Williams, White & Co., Moline, Ill., have been engaged to finish two dozen field-carriage axles, wanted at once to fit a number of seven-inch gun carriages that are to be shipped from the Rock Island arsenal.

—The Chicago Grain Door Company recently received an order from the Chicago, Milwaukee & St. Paul Railway for grain doors for 1,000 box cars to be built immediately at the West Milwaukee shops.

—The "Solid" brake beam, manufactured by the Monarch Brake Beam Company, is to be used on the new cars of the Ohio Central lines, and also on some repairs which the Cleveland, Canton & Southern is making.

—The office of the Bushnell Mfg. Co. has been removed from Easton, Pa., to New York. Communications to the firm should be now addressed to E. M. Bushnell, vice president the Bushnell Mfg. Co., No. 3 Cedar street, New York City.

—The "Diamond S" brake shoe, made by the Sargent Company, Chicago, was adopted recently by four large railroads aggregating about 8,000 miles. The steel casting department of this firm during the month of March showed an increase in business of 75 per cent. over the corresponding time of last year.

—The address in Pittsburgh of Manning, Maxwell & Moore, the Ashcroft Mfg. Co., the Consolidated Safety Valve Co., the Hayden & Derby Mfg. Co., the Pond Machine Tool Co., the Shaw Electric Crane Co. and Pedrick & Ayer has been changed from the Telephone building to the Park building, Fifth avenue and Smithfield street.

—The improvements in the machinery for handling the turrets of the Texas, by which the rapidity of firing is increased four fold, were designed by Lieutenant Haescler, whose brother, C. H. Haescler, manufactures an extensively used pneumatic drill in Philadel-

phia. A number of these drills were used in making the changes of the turret-handling mechanism of the Texas.

—The Simplex truck and body bolsters, manufactured by the Simplex Railway Appliance Company, Fisher building, Chicago, are to be used on all of the 800 cars recently ordered by the Ohio Central lines. Four hundred of these cars are to be built by the Wells & French Company, 200 by the Ensign Manufacturing Company and 200 by the Michigan-Peninsular Car Company.

—The Moran Flexible Steam Joint Company, of Louisville, Ky., have recently issued a revised price list which shows a reduction of 25 per cent from previous quotations for their flexible joints. The company have a new illustrated circular, which can be had upon application to the general offices at 149 Third street, Louisville.

—Mr. Boone V. H. Johnson has been appointed Assistant Engineer of the Safety Car Heating & Lighting Co., at St. Louis, in place of Mr. W. H. Hooper, promoted to the position of general agent of the same company at Chicago. Mr. Johnson was formerly with the Pullman Company, and recently with the New York, New Haven & Hartford Railroad Company, at New Haven, Conn.

—The Chicago Great Western has ordered two huffet cars from the Pullman works. The cars will be of decidedly novel design and interior finish. They will be 63 feet long, and will be equipped with Westinghouse brakes, Kewanee brake beams, National couplers, Standard steel platforms, Pintsch gas, Consolidated car heating system, wide Pullman vestibules and Standard 36" steel-tired wheels.

—The war department has made the following awards for gun carriages: Eight-in. gun carriages—Morgan Engineering Company, 5; Pond Machine Tool Company, 8; Walker Company, 3. Ten-in. carriages—Bethlehem Iron Company, 7; Southwark Foundry & Machine Company, 3. Twelve-in. carriages—Morgan Engineering Company, 6; Bethlehem Iron Company, 6; Robert Poole & Son Company, 2.

—The Barber truck, manufactured by the Standard Car Truck Company, Old Colony building, Chicago, is going to be used on six engine tenders of the Chicago Great Western, and the company are furnishing six sets to go under some cars which are being repaired by the Lake Superior & Ishpeming Railroad. The Barber truck is also to be used on the 300 refrigerator cars, which the Wells & French Company are building for Armour & Co.

—Mr. Charles Miller has been elected second vice-president of the Franklin Steel Casting Co. to succeed W. J. Welsh, deceased.

—The American Brake Shoe Co., of Chicago, has been incorporated with a capital stock of \$100,000, by Frank H. Drury, Julius N. Raymond and Otto R. Barnett.

—Messrs. J. A. Hinson and W. D. Hurford of the National Car Coupler Company have organized the Hinson & Hurford Steel Casting Company and have erected a plant at Converse, Ind., which is in charge of Mr. William Chambers as superintendent. The company will manufacture all kinds of open-hearth steel castings and do a general foundry business in addition to manufacturing the National coupler and National continuous platform buffer, handled by the National Car Coupler Company.—Railway Age.

—The aluminum "Flying Go-Devil," advertised on another page, is probably the most successful lure for game fish that has been invented. The writer of this paragraph has used it with great success for muscalonge, and black and Oswego bass, and wall-eyed pike. If anyone thinks it unsportsmanlike to use a lure with so many hooks he can take off all the gangs and substitute single hooks or attach a single hook to the rear split ring and dispense with the others entirely. It is a most satisfactory device in the hands of fishermen who have enough of genuine sportsmanship to stop fishing when they have caught a reasonable number of fish.

—The machine tool works which have been owned and operated by the Davis & Egan Machine Tool Co., Cincinnati, O., have been reorganized under the name of the American Tool Works Co., under the laws of West Virginia, with a capital of \$1,000,000. This is made necessary by the rapid growth of the business. The Davis & Egan Co. was incorporated with a capital of \$500,000, and has always paid 12 per cent. dividends to its stockholders. The stock of the new organization is to be issued half to represent the old interests, which is to be common, and the new half, which will be all preferred. Of the preferred, \$200,000 has already been subscribed; \$100,000 is for sale, and the remaining \$200,000 will be retained for the present as treasury stock. This preferred issue will be cumulative, 6 per cent. dividend, non-voting stock. All the old officers are retained, except Vice-President Burtner.

# RAILWAY MASTER MECHANIC

WALTER D. CROSMAN, Editor.

EDWIN N. LEWIS, Manager.

PUBLISHED MONTHLY BY

THE RAILWAY LIST COMPANY.

Devoted to the interests of railway motive power, car equipment, shops, machinery and supplies. Communications on any topics suitable to these columns are solicited.

Subscription price, \$1.00 a year, to foreign countries \$1.50, free of postage. Advertising rates given on application to the office, by mail or in person. Address

THE RAILWAY LIST COMPANY,  
The Rookery, Chicago, Ill.

The Official Railway List is Published by this Company.

VOL. XXI. CHICAGO, JUNE, 1898. No. 6.

IT SEEMS rather surprising that 30 years ago a locomotive made the modern speed of a mile a minute and on a western road at that. Yet a valued contributor tells of such a feat in this issue. A 16x22 locomotive, the first passenger locomotive built (in 1863-4) by the Chicago & Northwestern, did this in 1867.

A VERY suggestive contribution given in this issue, as to the desirability of instructing trainmen in the details of car construction and repairs, should command a considerable amount of attention. It is within almost every reader's experience, probably, that trainmen are frequently deficient in the "little knowledge" that Mr. Goodyear urges that they should possess.

THE railway world is to be congratulated upon the installation of the remarkable oil testing machine at Franklin Pa., which we describe in connection with our review, in this issue, of the new laboratories of the Galena Oil Company at that place. There has long been seriously felt the need of more exact knowledge of the lubricating values of oils, of journal friction, and of allied topics which have remained more or less obscure, and this machine bids fair to give this knowledge. While this machine will be devoted to the work of the company owning it, it must be remembered that the output of that company goes upon 95 per cent of the railways of the country, and its benefits will naturally be far reaching; and we may add that it is our understanding that the machine will be placed practically at the disposal of railway officials in search of the information which it is designed to afford.

VARIATION in height of drawbars was viewed from a legal standpoint in California recently in an interesting way. The Supreme court of that state had before it the question of whether a difference of 1½ inches in the height of the drawheads on two cars of a company was a defect which would render the latter liable for an injury caused thereby, or whether the increased risk, if any, was one which an employe, whose duty it was to couple cars, assumed by his employment. There was uncontradicted evidence to the effect that switchmen are likely to be called upon to couple cars between which there is a much greater difference than that between the two cars involved here. It showed that cars from other roads were in constant use, and that the cars built upon the same plan and on the same standard were often, by use, made to vary to the extent of three inches. True, the inspector put upon such cars a cripple tag as soon as he detected the defects, and when possible they were rectified. But a switchman was liable to have to couple them before the defect was noticed, and, the Supreme court says, must always be on the alert for them. In other words, it holds that if the risk of his occupation is thus increased it is a risk which he assumes by his contract. On this ground, the court holds (Holmes against Southern Pacific Company) that the difference in drawheads stated did not warrant a verdict

against the company; to which Mr. Justice Garoutte dissented.

## LOCOMOTIVE PROGRESS.

In our review of locomotive progress, given a year ago this month, we referred to a number of improvements which were then in an experimental stage, and we can now record the fact that all, or most of them, have become well established in practice. Mogul and 10-wheel engines with 63-in. centers and cylinders 20 or 22 diameter by 26 or 28-inch stroke are now the general practice for through freight trains. More engines of this class have been built in the past year than the American eight-wheel engine. For heavy grade work consolidation engines are still in favor, and for pusher service quite a number of Mastodon engines have been built for several roads. The large 10-wheel compound engines on the Northern Pacific Railroad have given excellent satisfaction, and the boiler capacity has been found adequate for larger cylinders, so that new engines of that type, just built, have the stroke increased to 28 inches, and they are equivalent to 20x28-inch simple engines. The only engines which exceed the size of the Mastodon engines on the Northern Pacific are the 12-wheel simple engines for the Great Northern and the new Pennsylvania railroad consolidation. These enormous machines mark the top notch of American locomotive construction so far as size and weight are concerned. The cylinders and boiler of the Great Northern engine are probably the largest for simple engines ever built in the world. The cylinders are 21 in. diameter and 34 in. stroke. The boiler is 78 in. diameter in front and enlarged to 87 in. diameter at the fire-box. The weight on drivers is 172,000 lbs., and the total weight of engine is 212,000 lbs. The boiler pressure is 210 lbs.

The distinctive feature of the past year's development is the demand for locomotives of large capacity in all classes of service. Tonnage rating of engines has materially increased the train load, and the economy of heavy train loads has been shown so conclusively that there is a general desire to still further increase it, and with this has come the demand for heavier power. Larger cylinders require larger boilers to supply them. Larger boilers increase the weight on drivers, and it is thus possible to use higher boiler pressure. While 180 lbs. may have been the maximum pressure in general use last year, 200 lbs. is now frequently used.

The economical use of steam at 200 lbs. pressure, when locomotives are heavily loaded, requires compound cylinders. It will thus be seen that the enlargement of the locomotive, more than anything else, has brought about a final recognition of the merits of the compound principle for locomotive cylinders.

The separate exhaust for the high pressure cylinder, which allows an engine to be handled more rapidly, and which increases the power of the cylinders for starting, or for preventing stalling on a grade, has been a large factor in determining the successful and practical working of compound locomotives on American railroads. This feature is now found on all the principal compound systems. It is used on the Schenectady, the Pittsburgh, the Richmond, and we believe by the new Baldwin two-cylinder system. The Dean compound has also been recently modified so as to have a separate exhaust, and we understand will be used by the Dickson Locomotive Works. The credit for this improvement, the separate exhaust, we believe properly belongs to Mr. Mellin, of the Richmond works, for it was a distinctive feature of his original design for compound intercepting valves, and was so successful from the start that it was soon taken up and incorporated in the designs of other builders.

In the coming year we expect to see more compound freight locomotives built for American roads than simple ones. The compound is no longer an experiment but an assured fact, and has come to stay.

It is remarkable that in a service so well adapted to the compound locomotive—that of a freight pusher on the Allegheny mountains—the Pennsylvania railroad has built a simple engine. The new consolidation engine for this service is very large and powerful, the capacity being nearly 50 per cent greater than the large Mogul engines used in freight service. This engine must consume an enormous amount of coal, and we know of no better oppor-

tunity for effecting a large saving by the use of compound cylinders, than in such an engine. The cylinders are 23½x28 in. and the driving wheels 56 in. diameter. The Belpaire boiler is 70½ in. diameter. The weight of the engine in working order is 218,000 lbs.

With large engines we have a corresponding increase in tank capacity, reaching as much as 5000 and 6000 gallons. The total weight of a large tank with coal and water is very nearly 100,000 lbs. This is equal to the weight of a large sleeping car carried on two six-wheel trucks. It is also equal to the weight of many good sized locomotives, with four 5x9 in. truck journals and two 8x10 in. driving journals. Yet these large tanks are carried on two four-wheel trucks with 4¼ or 4½x8 in. journals. The heaviest journal loads in passenger service today are under 5000 gallon tenders. The problem of providing a suitable truck for these heavy tenders, where there is such a wide fluctuation of weight, so as to make them ride easily, is one which has not yet been properly solved but which must soon have serious attention.

We can refer but briefly to some of the smaller details of locomotives, on which there is seen steady improvement.

Piston valves for both simple and compound locomotives have been so successful wherever tried, that there is a strong tendency to use them more generally. The use of high pressure steam—200 lbs. and over—will rapidly extend the use of piston valves, for they are so well balanced and easily lubricated that they seem to be a necessary adjunct to high pressure steam.

Nickel steel is gaining ground rapidly, and while the price is still a little fancy, quite a number of roads are making a considerable use of it for axles, crank pins and piston rods, and some few experiments are being made with this material for fire-box sheets and stay bolts.

Steel castings are improving in quality and the price per pound is down to a fair basis, and these conditions were only necessary to result in an extensive use of this material in locomotive construction. Two railroads in England have their own steel foundry, and the constant use of them shows how largely cast steel can be applied to locomotive construction. Driving wheel centres of cast steel have become a necessity, for with larger cylinders and high pressure the effort on the crank pin is so great that cast iron has not sufficient strength to resist it. High pressure steam is also leading us to the use of cast steel cylinder heads and steam chest lids, and it will soon result in steel cylinders, with cast iron bushings and false valve seats.

The locomotive is making rapid strides in the direction of greater efficiency as a hauling machine, and greater economy as a heat engine. While malleable steel for forgings, and steel for castings, are meeting the requirements for machinery, boiler and fire-box steel still remains at the old mark, as to tensile strength, and ¾ in. and 7/8 in. sheets are necessary for large boilers. During the next year we expect to see some development in the direction of a more suitable grade of steel for high pressure boilers than that now used.

## CAR CONSTRUCTION FOR A YEAR.

It has been the practice of the Railway Master Mechanic to review in the June issue each year the progress made in car construction during the previous twelve months. For several years it has been necessary to confine such remarks to freight equipment quite closely because during the period of light traffic railroads were more inclined to make use of what passenger equipment they had rather than to incur the expense of new. On account of the decided improvement in business, however, and the noticeably worn out appearance of the passenger equipment the officials have of late looked with favor upon propositions to purchase new cars, and very frequently the purchases made have been of entire trains, each road, of course, getting the "finest ever produced." This rivalry between the roads to provide elegant facilities has probably been most pronounced in the middle section of the country. It would be quite impossible to undertake a description of the interior decorations of the year's new equipment, but mention may be made of a few of the features which seem essential for the "finest train on wheels."

Such a train should be, it is now generally con-

ceded, lighted by electricity, and some useful though unusual arrangement of the lights, as over the outside vestibule doors for instance, is entirely in order. Usually the electric current is obtained from a generator located in the baggage car and operated by an engine which is supplied with steam from the boiler of the locomotive. There must be a buffet car with library, smoking room and buffet, and to get full returns from this car smoking must be prohibited in the compartments of the other cars usually set aside for this purpose, so that smokers are at least driven to drink. Compartment cars seem to be quite attractive and the up-to-date train has one or more compartment cars; among railroad men, however, they are referred to by other more suggestive names. The interior finish of these cars is very elegant, but there is a decided tendency toward plainness and avoidance of projections on which dust can collect. The broad vestibule is absolutely necessary, the narrow vestibule being entirely out of date.

The tendency in freight equipment is very decidedly in the direction of cars of large capacity—80,000 and 100,000 pounds—with 120,000 pounds capacity mentioned. Several roads have built cars of 80,000 pounds capacity, mostly coal or ore cars, and one or two have built cars of 100,000 capacity, but probably every road of any note has under consideration, at least, cars of these larger capacities. The question of supporting these larger loads on the center plate is a rather serious one on account of the limited space allowed by other prescribed conditions, so serious even that some are considering the advisability of carrying part of the load on the side bearings and have gone so far as to design suitable side bearings. This might do on roads made up largely of tangent track, but on a road having many curves there would quickly result a decrease in the maximum total weight of trains, as has been demonstrated by experiments to be the case when cars are riding heavily on the side bearings.

It seems to be the general opinion that wherever there is traffic enough of one kind to insure full loading of cars in at least one direction, there will result a saving in the use of the larger capacity cars. For instance, if a railroad requires 3000 cars of 40,000 pounds capacity to handle its own coal, there would be a material saving in cost of hauling and in track space required for storage by using cars of 80,000 pounds capacity. There is, however, a possibility of carrying the large car idea to the extreme, to the point where the increased capacity cannot be used advantageously by the shipper, or to a point even where it would work a hardship on the shipper. For instance, the coal dealer who can dispose of only 30 tons of coal in the time usually allowed for unloading a car after it is placed, cannot handle 40 tons in the required time and must pay demurrage (it is always the small dealer who pays demurrage); in such a case the large car would not be of advantage. Again, the number of men who can work to advantage in a car is the same in either the 30-ton or 40-ton car, and the same number of teams can approach either so that when the unloading is done in this way the shipper soon finds the difference in cost and his men soon find the difference in the height of the sides of the car. There is traffic certainly in which the larger cars can be used to excellent advantage, but it is quite possible that in the eagerness to fill the legitimate demand an over production of large cars may result.

There seems to be but little inclination to build box cars of a capacity greater than 60,000 pounds, and such tendency is not likely to be pronounced for some time yet, although the average loading is slowly increasing.

The designs for cars of 80,000 pounds capacity have not generally been directed toward steel construction for the body of the car; but the cars of 100,000 pounds capacity are entirely of steel and it is probable that the line dividing steel and wood construction will be drawn between capacities of 80,000 pounds and 100,000 pounds. Another line of demarkation lies probably between cars of 60,000 pounds and 80,000 pounds capacity and is noted in the bolster construction. It is probable that the well known form of plate body bolster will be abandoned with the step which has been about measured off during the past year, to 80,000 pounds capacity, and body bolsters of stronger construction and, generally, of special design will replace it. This,

at least, is the tendency. The wooden and composition truck bolsters will undoubtedly end their service with the cars of 60,000 pounds capacity. In other respects the cars of 80,000 pounds capacity have been developed from the cars of 60,000 pounds capacity by increasing the dimensions, and sometimes the number, of the sills, the depth of the trussing, and sometimes the number, of the truss rods, and by increasing the length, width and height of the body. The dimensions for trucks for cars of 80,000 pounds capacity, as prescribed by M. C. B. recommendations, are proving quite satisfactory; this relates to dimensions for arch bars, journals and axles. It is undoubtedly the case, however, that what are generally referred to as metal trucks will be more favorably and more generally considered for cars of a capacity above 60,000 pounds.

When the bodies of cars of more than 80,000 pounds capacity have been built or considered the pressed steel construction has been favored, and it is probable that this form of car will have a permanent influence in the design of what are now called large capacity cars.

#### FUEL ECONOMY.

Because the cost of fuel on railroads is the second largest single item of expense, and because by far the largest part of the fuel purchased is consumed by the locomotives, there is an ever-watchful eye kept over the coal pile, and the mechanical officers have ever before them the problem of doing a given amount of work with a gradually decreasing cost in fuel. It is necessary that the mechanical officers appreciate thoroughly the necessity of making every provision possible to save a pound of coal, and it is believed they are thoroughly alive to such necessity although they, being human, sometimes get tired of a continual grind and become a little lax until the fuel reports show against them or until a superior officer applies the spurs again and they hasten to retrieve the lost ground. A grind is something to be abhorred and it is possible that nothing worries the motive power department quite as much as the eternal scheming to get this month more work out of a pound of coal than was obtained last month or the corresponding month last year, or to, at the worst, not fall behind previous records. If the latter should happen then there is a very active search for some reasonable excuse for the backsliding, and a heavy sigh of relief is the result of a fruitful search.

For the reason given in the first sentence of the above it is not surprising that this nightmare should ever be kicking the motive power department; and eternal vigilance must be rewarded by success, providing that vigilance is well directed. It is discouraging in the extreme, however, to scheme in every manner possible to provide a boiler which will generate steam at the lowest possible cost in fuel, and to design a valve motion and cylinders which will get out of that steam all the useful work possible, and then find this masterpiece of mechanical genius operated by one who, if he appreciates the value of his charge, either does not know how to handle it to the best advantage, or, if he does know, does not show that he does; or to find it subject to the orders of one who will not assume the least responsibility for the economical handling of the machine, but whose orders seriously affect the cost of hauling freight.

The first reference above is to the engineman, he who should be solely responsible for the economical handling of the entire steam plant, which the locomotive really is, responsible for the results of the fireman's labors, as well as his own, but which former he is very anxious to shirk—to the engine-man who, with a first-class modern locomotive continues to use, month after month, as much, or more, fuel to do a given amount of work, as another engine-man does who has charge of an old "rattle trap" or "mill." The master mechanic is responsible for the kind of power placed at the service of the operating department and also for the service rendered by the man put in charge of the power; this being the case, why is it that so much attention is given to the former when so little is given to the latter? Or, rather, why is not more attention given to the latter? It is not strange that the records show, month after month, that certain engine runners haul trains at the lowest cost for fuel, even though they may be transferred from one locomotive to another; but it is

strange that there should be rules which require the youngest runner to give up his machine to an older runner, when the latter's machine is taken from service for any cause, with no consideration of the quality of the service rendered. This is a premium on incompetency, for frequently the youngest runner is hauling trains at a lower cost, in fuel and other supplies, than the man for whom he must make way; and the cost of hauling is just as important as the price received for hauling. It would seem to be an excellent idea to have, with a certain lot of men in the engine service, a premium placed upon good service rendered, or a ban placed upon service of inferior grade, by requiring that when a locomotive is taken from service its engineer take the locomotive of that engineer in the same kind of service whose fuel and supply records have averaged the lowest for a fixed period previous. This would mean simply setting back the more expensive engineer to a position where he might be supposed to learn more about the economies of handling locomotives; and to this end it might be advisable to place such a man at such a time with the engineer in the same class of service whose record was among the best. This would be a premium system which would result in much benefit to the railroad company and to those of the men who were using their machines and knowledge of them to the best advantage, and there would be no onlay by the railroad.

The employes whose orders affect greatly the coal consumption, but who are seldom held to strict account for the same, are the train masters, yard masters, and dispatchers; the last to the greatest extent. This declaration may need some explanation. The fuel and supply cost for hauling a train from one division point to another must include all the fuel and supplies used from the time the locomotive leaves the house for its assignment, until it is hosed again at the other division point. Were it possible to know just the time each train would be ready to start from one division point, and that it would have a clear track to the next division point, and a time fixed for the run, then probably the motive power department alone might be held responsible for the fuel record; but when trains are reported to be due several hours before their actual arriving time, and the condition of traffic on the road, or method of handling the same, makes necessary long lay-outs between division points, then the operating department should bear its share of responsibility for extra cost of fuel and supplies. The train dispatchers have trials of their own, and on single track lines particularly it is difficult to make close meeting points, but while the mechanical officers are doing their utmost to show a reduced fuel and supplies cost for hauling tonnage, some responsibility for such cost should attach to the operating officers to insure against increased fuel consumption on account of long layouts on the road and other causes which are under the control, to greater or less extent, of the operating department. Probably only a few appreciate what a large amount of coal is consumed in yards waiting for trains, and on side tracks waiting for various causes. For the fuel which is burned at such places, however, on account of open ash-pan dampers, open stacks, and the effect of the exhaust from the air pump on the fire, the motive power department is undoubtedly responsible and this is a considerable amount of the total consumed at such places.

The article entitled "Men and Machinery," written by Starr Hoyt Nichols, and published in the May number of the North American Review, is well worth reading by all who are interested in the labor question, especially by workmen who think and who honestly desire to get at the truth of things. The conclusion of the article, which gives some idea of its general tone and scope, is as follows: "What Henry George expected through his single tax, a millennium of plenty, will come through improved machinery. What statesmen expect through just laws, a millennium of order and progress, will come through improved machinery. What moralists and reformers expect through excellent sentiments and right reason, a millennium of virtue, will come through improved machinery. What prohibitionists desire through legislation, a millennium of temperance, will come through improved machinery. What socialists and anarchists seek for by new industrial conditions, a millennium of comfort to all classes,

will come through improved machinery. What the church seeks to bring about upon the earth, a millennium of peace and good will to men, will come through improved machinery. For machines multiply goods into plenty, and plenty broadcast means peace and kindness and comfort and temperance and gracious thoughts and reasonable minds and civil order and equal laws. A natural plenty like that of Samoa does not mean all these things; but a made and manufactured plenty, by reason of the industry it engenders, brings all millenniums into its hands, and nothing else can. Therefore, its agent, the machine, must prevail, whoever may oppose."

## COMMUNICATIONS.

### The M. C. B. Coupler.

Indianapolis, Ind., May 31, 1898.

To the Editor of the Railway Master Mechanic:

Referring to your article on the M. C. B. coupler in your April issue, I would say that in my judgment the main trouble in regard to the M. C. B. coupler on the start, that is, when it was first put into service, was that the railroads allowed the coupler men to tell them what they wanted. The coupler men undertook to change the contour lines and make the coupler of any metal that would hold together long enough to make a few miles; but after the M. C. B. Association took up the matter and established gauges, showing just exactly what the contour lines should be, and established a drop test, then the railroads commenced to get some results from the M. C. B. coupler.

Regarding your first point, as to the outline and general form of the coupler, when you say that the only attractive feature is that it will sometimes couple automatically, which you regard as being quite a saving to railroad companies in the matter of money being paid out to train men for personal injuries—the point you raise in that connection in regard to trains being made up in yards, where there are sharp curves, I think is rather a broad statement, and should not condemn the coupler as to its design, for I have seen railroad yards where it was impossible for a yard engine to move more than one car at a time and the coupling used between the engine and the car was about 6 ft. long, in other words, was a pole, with an eye on each end connected with the coupling on the car and on the engine. Railroad yards, as a rule, are constructed to meet the surrounding conditions, such as a lack of ground, and rather than buy property, they will run around a house. I do not think any device that could be gotten up by the mechanical department could be expected to meet any such requirements as this.

Regarding your next point where you say "this lack of side motion has been the cause of wrecks to equipment which has been coupled on tangent track or on track with radius sufficiently great to allow couplers to engage, and then run over curves on which couplers would not engage." This statement I do not think is hardly fair, as I have never heard of anything of this kind in regard to freight cars or freight trains, but the statement would refer especially to passenger trains. I have known cases where long express or postal cars (60 ft. frame) have been built where it was known positively that these cars must run next to a tender in all trains. At the same time the tender was equipped with stationary buffers and stationary couplers, bolted rigidly to the end sill of the tender frame. This construction was rigidly adhered to until several derailments occurred; in other words, with the heavy overhang of the postal or express car and the short overhang of the tender and rigid couplers and buffers on the tender frame, there was of course not allowed any motion except that given by the car buffers and couplers in rounding curves, which was insisted on as being sufficient, until derailments became numerous, and then the matter was looked into and the construction of the tender changed. Ordinarily this construction might work on a road where there are very few sharp curves, but would not answer on yard tracks. This is a case where it is unfair to blame the coupler, as any design of coupler could not have prevented derailments with such "bungling" construction.

Regarding your "secondly" as to the lines of the M. C. B. coupler and the proportions of the parts approved at a time when railroad equipment was much lighter than at present and the tonnage per train much less than at present, I think the coupler was designed sufficiently strong at the time, and I agree with you that a grave error was made in not providing for increased strength to meet the requirements of cars carrying 80,000 to 120,000 pounds. As you are quite right, the only means left open for increasing the strength of the coupler must now be made in the quality of material used. If you will refer to pages 133 to 140 of the M. C. B. Association Proceedings of 1889, held at Saratoga June 25, 26 and 27, giving a report of the committee on M. C. B. couplers, and to page 140 to 143 giving the discussion, you will note that this committee was composed of Mr. Schroyer, of the Chicago & North

Western Railroad; E. B. Wall, of the Panhandle, and myself, of the Baltimore & Ohio. I disagreed with the report made by the committee establishing the size of the neck or tail end of the coupler which the committee reported at 5 in. x 5 in. as having sufficient strength. In disagreeing with this committee, I made the statement that in my judgment the size of the neck should be 6 in. horizontally and 5¾ in. vertically, as a neck of 5 in. was not sufficient, resting on the carrier iron, to hold the head in proper position. If this size of the neck or tail end had been established at that time, it would have been in pretty general use and the center timbers on all cars would have been spaced to receive a coupler of this size. While these dimensions were not necessary at the time the coupler was adopted, as a neck 5 in. square was sufficient for a car of 60,000 pounds capacity, I am of the opinion that it is hardly heavy enough for cars of greater capacity than 60,000 pounds, and railroads seem to be determined to build cars of greater capacity than 60,000 pounds.

There has been in my experience surprisingly little trouble with the present coupler, and my only contention has been that the neck should have been larger, and with the increase of the draft arrangement, we could have gotten almost any strength desired.

E. W. GRIEVES.

[Formerly superintendent of car department B. & O. Ry. and now with the Galena Oil Company.]

### Changing M. C. B. Prices.

To the Editor of the Railway Master Mechanic:

At the last convention of the Master Car Builders' Association, an objection was raised to the present prices of material and labor allowed by the M. C. B. rules of interchange.

It was claimed that these prices would not cover the cost of work on some of the western roads and that an extra charge, by these companies, should be allowed.

The matter was referred to a committee to report to the next convention, and as a few of the roads are especially interested in the subject it is fair to assume that they will use every effort to have it favorably considered.

As this is a matter which would affect all roads to a greater or less extent, it would be well to carefully consider it before making any changes in the present prices.

The total number of freight cars in the country at the present time, is about 1,200,000, the great majority of which are represented in the M. C. B. Association. About 78 per cent of these cars belong east of the Mississippi river and would receive no benefit from the proposed change. The remaining 22 per cent are made up principally of the trunk line cars running west of the river, and include the Pacific coast and mountain roads, the two latter of which control less than four per cent of the total cars in the country.

The proposed change would undoubtedly be a benefit to this latter class, who are compelled to pay freight, from the east, on almost all of the material which they use; but is not their loss fully covered by the repairs to their cars on eastern roads at a less expense than they can repair them at home?

If the division was made on a line connecting Omaha and Kansas City, as has been proposed, would it not give an unfair advantage to roads having an eastern terminus, especially if a road had repair shops on both sides of the line? In this case they would be allowed two sets of prices, notwithstanding the fact that their material and labor cost the same at both points.

If the division was made on the 103d meridian there would be less trouble of this kind, but it would also reduce the number of cars interested to less than 14 per cent, about 11 per cent of which would have eastern terminals, where material could be purchased at eastern prices; and as only a small number of these cars are repaired west of the 103d meridian the proposed change would be of only slight benefit to them. Is it reasonable to advocate this change in the rules to benefit less than 4 per cent of the cars represented? And would it not be more reasonable for the larger number to object to the overcharges allowed the southern roads, who represent more than 10 per cent of the total cars, where labor and material cost very much less than the prices allowed by the rules?

A claim of this nature would be just, to the roads interested, in the same proportion that an increased price would to the mountain roads.

As the present prices have been in use for a number of years and are probably as equitable as the combined wisdom of the association can suggest, it would be much better to let them remain as they are than to advocate a change, which would open the door to claims for a different price for each section of the country, wherever a railroad company thought some other road had an advantage over it in prices.

It is fair to assume that, under ordinary conditions, the number of cars repaired on foreign roads about offsets the number of foreign cars repaired on the home road, so that an overcharge in one locality is balanced by an undercharge in another.

It would probably be well to add several more items

to the present list, and possibly to reduce the price on a few of those now in use; but it would be much better to let them stand as they are, rather than make any increase whatever to accommodate any particular section of the country.

H. M. PERRY.

### Braking Trains in Mountain Service.

To the Editor of The Railway Master Mechanic:

I have often heard of the Le Chatelier water brake, and have heard said of it that it is a valuable aid in handling trains down mountain grades. I would like to know how it works, and where it is in use.

Master Mechanic.

[Probably the most systematic use of the Le Chatelier brake, in this country, is to be met with on the Southern Pacific Ry. An extract from the regulations for its use on that road will give a fair idea of its application and the methods used in employing its aid. We append this extract, as follows:

"The Le Chatelier, or water-brake, is intended to be used as an auxiliary to other brakes, and, when used with discretion, is a valuable aid in steadying a train down mountain grades. It is most effective on a steady motion of from three to 12 miles an hour, above which latter speed it is of lessened value. It should not be used at a greater speed than 18 miles per hour, and is for mountain work only.

"Water is led by a small pipe connected to the boiler, below water line of same, to the exhaust-pipe cavity and through to the cylinders. This affords a counter pressure on pistons when engine is reversed. The reverse lever should be just back of the center notch of quadrant. The act of forcing compressed moist vapor—which the water jet drawn into the cylinders with engine reversed supplies, back into the boiler, causes a retarding force on pistons, which, operating through the connections on the crank pins, gives the desired brake power. Only a very small amount of water is used, a portion of which, all except that converted into vapor and returned to boiler, passes through the open cylinder cocks. The amount of brake power exerted depends upon the position of the reverse lever.

"In operating the water brake, first have the engine in slow motion without steam; have cylinder cocks wide open and keep them open, with reverse lever placed one notch back of the center, and throttle securely shut. Give the small water-cock one-eighth of a full turn open, and see that steam-water passes the cylinder cocks freely.

"The speed may now be regulated by placing the reverse lever back as required. This should be done without any change in the water cock. A too free use of water is dangerous to cylinder heads, and water may be forced out of the smokestack, producing no useful effect.

"In shutting off the water-brake throw the reverse lever ahead slowly, first closing the water cock, to avoid throwing water from the stack.

"It must be remembered that the water-brake acts on the drivers, and that the combined use of water and driver brakes will be too great, causing the sliding of wheels, hence the combined use of water and driver brake must not be made, except as herein-after provided.

"Light engines, when fitted with air and water-brakes, are best controlled by setting the water-brake moderately and using the air-brake to regulate speed.

"In case of necessity, the water-brake, the air-brake and all other available means may be used together.

"When two engines are coupled to trains descending mountain grades, the engineer not operating the air-brake must assist in retarding speed by using the water-brake to some extent, with the view to preventing flat and heated wheels. The water-brake should not be used at a greater speed than 18 miles per hour."

The fact that a person was employed by a railway company to remove ashes and fire from its engines, the Supreme court of Iowa holds, does not tend to prove that he was employed to move engines, or that he had any implied or apparent authority to move them. On the other hand, it suggests, in *Morby* against the Chicago & Northwestern Railway Company, that the fact that clinker pullers did at times move engines, if known to the foreman in charge of the work, and not forbidden, might tend to prove that they acted by authority, even though the practice did not amount to a general custom.

## PASSENGER ENGINES—RETROSPECT AND PROSPECT.

BY GEO. W. CUSHING.

Improvements in locomotives, as now evidenced in many new designs of both compound and simple classes, large and small, with increased steam pressure, increased diameter of cylinder, length of stroke, weight on drivers, tractive power, etc., together with improvements in their construction and in materials used to meet modern requirements—all these lead to a frequent expression, viz., "We have gotten to about the limit." This expression was, however, freely used years ago; in fact, except for the greater variety of locomotive types, and except for our much improved roadbeds and tracks and our modern methods and facilities of operation, the present reflects the past in all essential features.

The advent of steel in the structural parts of locomotives, and in rails, and in bridge building, has made practicable today what was only in hopeful

in the consolidated list. Of the number there were 7 engines built by the Chicago Locomotive Works during the period from 1853 to 1856; and it is likely that these dates marked the advent and the close of locomotive building in these works. The Galena road had also itself built and re-built engines prior to the consolidation.

Passing now to a notice of the old Chicago & Northwestern road proper. With the commencement of the active life of this, as a constructing road, was first used the engine "Winnebago." This engine had four drivers, 11 $\frac{3}{4}$ x20" cylinders, 48" wheels, chilled tires, and weighed 36,000 lbs. It was built by Hinckley, of Boston. Up to 1858 all the engines purchased for the Chicago & Northwestern came from this builder; they numbered 15 in all and were all larger engines. The first very heavy engines purchased were four Baldwin ten-wheelers with 18x22" cylinders and 54" wheels, and weighed 70,000 lbs. and having large tanks—1900 gallons. These were bought in 1864. This venture of the

shown was a successful steamer and was economical in the use of coal; furthermore its spark emission was not greater than is now seen in some instances with modern extensions and straight, open stacks.

Referring further to the illustrations, it should be noticed that the engine is not fitted with sight-feed lubricators. When new the engine had plain D slide valves (non-balance), and with 120 to 130 lbs. of steam pressure, and the engine worked to capacity, the valves required frequent oiling. The running boards were of a good width and afforded safe passage for the oiler to deposit the requisite portions of tallow in the chests.

In the dome was placed one pop valve (a road pattern and about the first) with its spring inside of the boiler, thus controlling from over-pressure and from outside interference. One of the safety valves had a lever extending into the cab and was connected with a scale balance and an eccentric motion at the boiler stand; this was used to ease up on the steam pressure when going into stations so

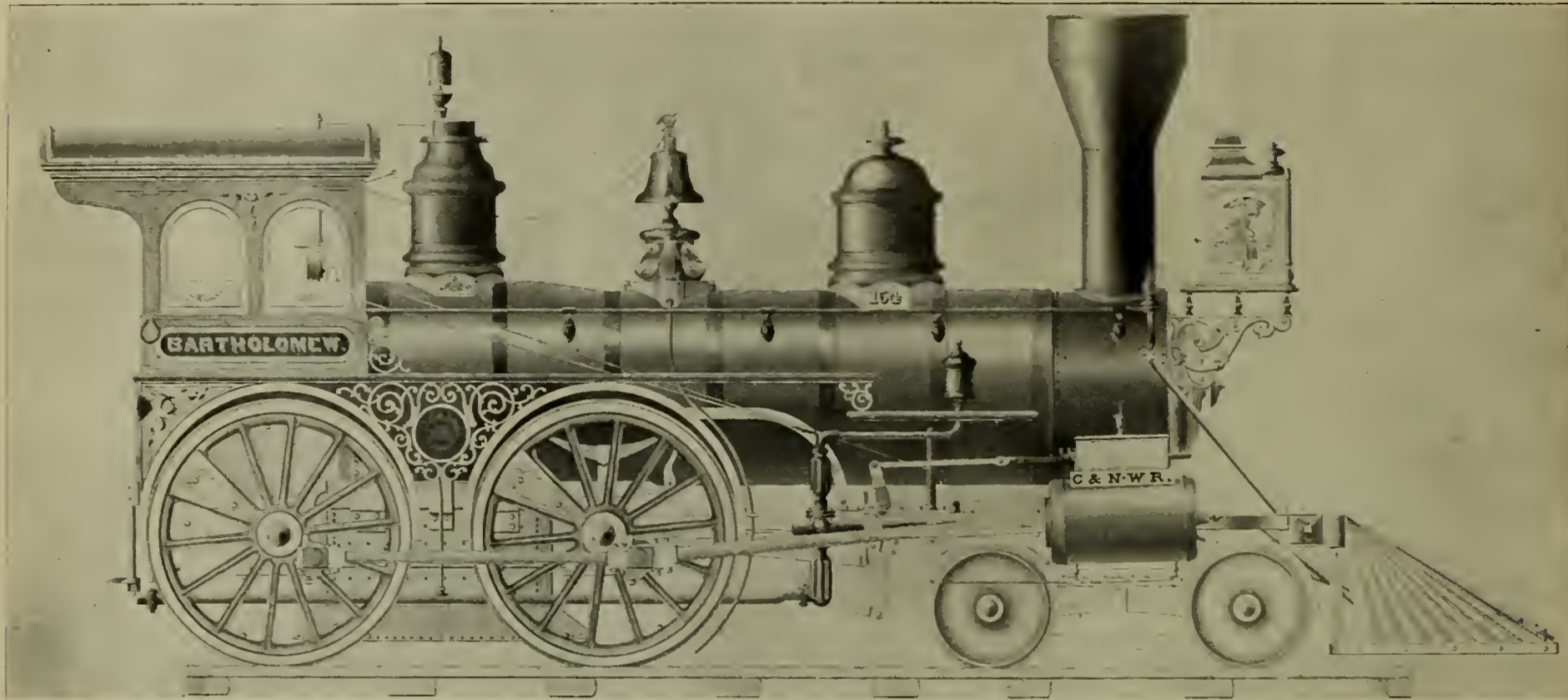

THE FIRST PASSENGER LOCOMOTIVE BUILT BY THE CHICAGO &amp; NORTH WESTERN R. R.

Designed by Geo. W. Cushing, Master Mechanic.

Chicago Shops, Wisconsin Division, 1864.

prospect to the engineer of years ago. To Bessemer are we largely indebted for the present status of engineering. Surely no one man did more in modern times to advance railroad engineering or to make this advance possible. The early master mechanics were very active in pushing out new ideas in their designs; and in encouragement to others to do so the leading men promptly availed themselves of every road improvement, and of the changes in views of managing officials which favored advance or the removal of objections to an increase in tractive power, and latterly certain chief engineers have co-operated actively also.

The Chicago & Northwestern system may be taken as a conservative example of the western roads, and reference to it in this article may cover the experience of other roads as referring to the machinery departments of early date. As today constituted the Chicago & Northwestern represents a consolidation of roads formerly operated independently, and of lines since constructed by the system. The oldest portion of this system was the Galena & Chicago Union (now the Galena division). The Chicago & Milwaukee (now the Milwaukee division) was another of the earlier lines and the present Wisconsin division was the original Chicago & Northwestern whose title governs the present system.

The Galena was an important road; its business and prospects were the best, and it came to the system as a public surprise. With it came 78 locomotives, ranging in size from "The Pioneer" 11x18 single driver up to 17" engines, the greater number having cylinders 15" or less. The "Pioneer" was floated up the lakes to Chicago and in about 1849 was used to commence the pioneer work in road building. The Galena engines "averaged up" finely

management was welcomed by the master mechanics of the road, but the engines were for quite a time thought to be very heavy on track and roadbed. Their performance however was satisfactory.

From 1863 to 1870, inclusive, there was a period of great activity in locomotive building, and while the company purchased a great lumber, its own shops also built as many as was consistent with giving the proper attention to repairs. The first freight engine built in the Chicago Avenue shops was erected in 1863. It was a 16x24, eight-wheel American engine, and was called "The Champion." The first "Butcher" steel tires purchased for this company were used on this engine.

The first passenger engine built by the Chicago & Northwestern was erected at the Chicago Avenue shops in 1863-4 and this was called "The Bartholomew." I submit herewith the original drawings of this engine. It was an eight-wheeler, with 66" drivers, 46" boiler, 54x39" firebox and 16x22" cylinders. The boiler was fitted with the 152 two-inch copper tubes 11 ft. long. It had Bowling iron tires, and an iron firebox. Its weight was 61,000 lbs. This description, with a change to 24" cylinder stroke, and to a steel firebox, iron tubes, steel tires and a weight of 64,000 lbs. will serve for a number of other locomotives of this class afterward constructed.

The "Bartholomew" was originally a wood burner, but was soon changed to a coal burner. The stack shown in the drawing is for coal, and was a modified design of the old Hunter (so-called) coal stack. A peculiarity of this modified stack is its spark receptacle in the stack body, and its adaptability for use of either wood or coal in case of a temporary change in fuel. With the proper arrangements in the front end—of lifting pipes, etc.—this form as

as to avoid the sudden report caused by the pop-valve discharge of steam. No rod oil cups were used on the back end of the main rods or on the side rods. An oil cellar was fitted beneath the straps, and these were usually filled as needed at terminal stations. The rod motion, together with a wick on a "feed stick," fed the oil in quantity as desired to the crank pins, and there was little waste oil found on the engine drivers or the jacket. The eccentric straps were also made with oil feed receptacles beneath the strap; this precaution was more necessary then than now because of the non-balance valve which, even with the low pressure used made great friction on the valve seats, and the cylinder lubricant, of tallow, was quickly overcome with friction and heat.

At this time not even "one injector on a side" was used; hence the old-fashioned pumps are a prominent feature to be noticed. It is true that injectors were fitted on some of the early engines, but they were in those days too troublesome to be relied upon. Bell ringers were then not generally available; hence the eagle on the bell yoke fitting was employed, being supposed to help the firemen overcome the balance weight of the bell. Driver brakes—indeed all power brakes—were absent in the fittings of this engine, although the Longridge chain brake was used on a few engines and trains.

The first of the "Stevens steam expansion ring" pistons were on these engines, and were a notable improvement over the old brass rings which required so much attention to properly adjust and repair, and which at times, when not properly adjusted or repaired, greatly decreased the power of the engine.

Thomas King, who ran this engine when it was



new and for years afterward, is still an employe of the Northwestern system, I believe, in some capacity. He was a well-known character in those days of workers, a good representative of the old school runner, many of whom have remained through to the present and are yet good men. The "Bartholomew" with King for the engineer made a notable run sometime in 1867, which was mentioned in London Engineering (in the volume for 1868 on page 456) in connection with a double page engraving of a brother engine. The occasion of this special run was a delay upon a lake steamer coming into Green Bay, at that time the northern lake terminal of the Northwestern system. This steamer had aboard Mr. Thomas Scott (then vice president of the Penn-

sylvania Railroad) and party who desired to reach Chicago quickly. Engineering states: "three engines were use on the trip; one of these, the 'Bartholomew,' ran from Janesville to Chicago, a distance of 91 miles, with three cars, in 95 minutes." If from this time we deduct a stop at Harvard for water and oiling, also a slow run in Chicago city limits we find that the running time was averaged at a mile a minute. The load of this engine on this trip was a commissary car, a baggage car and a business car. These were lighter in those days than are similar cars of today of course; but in attempting even a remote comparison of the performance of this engine with that of the modern engine it will be apparent that, taking into consideration the

steam pressure (120 lbs.), her boiler capacity, and her cylinder dimensions, she showed speed capabilities indicating that for effective use of steam her design was pretty well up to date—for her time. This would be a good performance at any time but it is mentioned only to show that the old-timers were capable of speeding and did speed when required. These engines, in the course of time, secured improved appliances and held the course well; all of them, with many larger ones with low pressure steam are giving way and will continue to give way to high pressure simple engines, and increased capacity compound machines until a limit is found, and then electric motor engines, with power generated at local stations, may possibly become a prac-

IS IT DESIRABLE TO INSTRUCT TRAINMEN IN THE DETAILS OF CAR CONSTRUCTION AND REPAIRS?

BY J. H. GOODYEAR.

The title of this article might lead one to believe it is intended to advocate the carrying (in the guise of a brakeman) of a car repairer on trains.

Such is not the intention, but rather to analyze a subject which for a considerable time has presented itself to the writer as a fertile one, and one to be sooner or later brought to the notice of those interested in the management of railways. In these days of competition, dispatch, with safety for freight, combined with comfort for passenger service, are important factors in the successful operation of a railway, and if the service can in either respect be improved it is undoubtedly to our interest to do so.

That there is room for improvement and that such improvement can be made by instructing trainmen to some extent in the details of car construction and repairs, I shall endeavor to prove by certain cases brought to my notice, believing that similar conditions exist on many roads at the present time.

First in order comes that bugbear of our existence—"hot boxes." Who has not received a letter from the Superintendent stating train No. — was delayed forty minutes on account of hot box on a car of time freight, car eventually having to be set out, a considerable distance from destination, on account of a cut journal? Conductor's report showed car running "stinking" hot forty miles from point picked up—delayed ten minutes cooling off and repacking—twenty minutes applying new brass, and ten minutes setting car out after vainly trying to get it in shape to run.

How many such cases, when investigated, show that the car was picked up at a station not a repair or inspecting point, and that had the trainmen taken the precautions to examine the journal boxes before starting, or have given the box proper attention before it got so hot, the delay to the train and the setting out of the car would, in all probability, have been avoided.

Recently a train was ditched (four cars totally destroyed and five or six more or less damaged) claimed to be caused by the journal under one of the cars burning off. Investigation showed that the car in question (which was loaded with sand) was picked up a few miles from the scene of the wreck and that nothing wrong was noticed until just before the ditching of the train. It is said that a little knowledge is dangerous (and the remark has been applied to the question now in hand); but one can but think that a little knowledge properly applied would, in the case of this wreck (by noting that the packing in the journal box was abstracted before car was picked up, or that the car was very much overloaded), have saved the company a considerable amount of money.

Numerous cases have occurred where cars have been set out at way stations on account of a broken draw bar spindle and spindle key; defects which trainmen could, with a little knowledge and proper material, make good in five or ten minutes and thus avoid delay to the car and save the car repairer making a trip of perhaps fifty or sixty miles, consuming the greater part of a day, for a few minutes work.

The car inspector at a small station, while inspecting a train, discovered a car with a bottom arch bar broken, a top bar bent, etc. The car had been picked up a few stations beyond; and one can imagine what would have occurred—as in all probability the trainmen would not have detected the defects until too late—had not the car just at that time reached an inspection point. On another occasion a car was set out with a coupler pulled out, two lug straps, lug castings and one draft timber missing, and the other draft timber and end sill considerably damaged. This car also was picked up at a point where there was no car man; and the examination showed the damage to be due to old breaks in the draft timbers, which were in fact badly decayed. This car was not safe to handle, and a little knowledge would have convinced the trainmen of the fact.

Much delay and labor would also be saved were trainmen in a position to correctly report defects, and to realize the importance of taking parts of draft rigging, etc. (particularly on foreign cars), in with the car when damaged.

Considering, now, passenger cars, we have cases

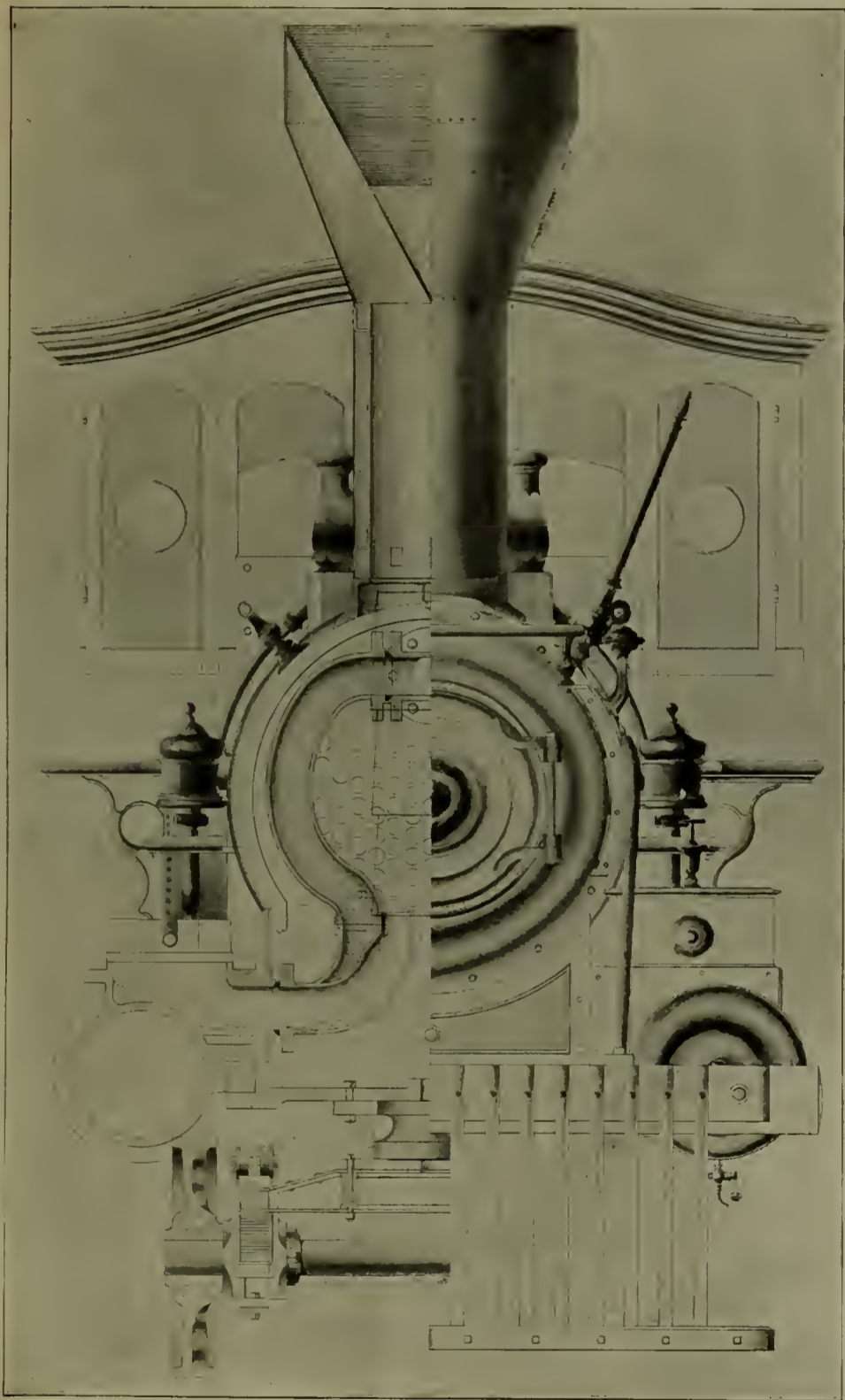

THE FIRST PASSENGER LOCOMOTIVE BUILT BY THE C. & N. W. R.

tical achievement. This result, when it comes, will be aided no doubt by improvements in electrical engineering plants and in electric motors, thus calling many hundreds to higher duties—not discharging them from care. History does repeat and tomorrow grows out of today.

The improvements during the past two years in the tracks of the Baltimore & Ohio road between Washington and Pittsburg are very noticeable to those who ride on the fast trains of that company. The curves seem to have been almost entirely taken out of the main line. The traveler now experiences no discomfort and can fully enjoy the magnificent scenery through which the road runs.

The improvements during the past two years in the tracks of the Baltimore & Ohio road between Washington and Pittsburg are very noticeable to those who ride on the fast trains of that company. The curves seem to have been almost entirely taken out of the main line. The traveler now experiences no discomfort and can fully enjoy the magnificent scenery through which the road runs.

of passengers subjected to annoyance owing to cars being cold, many such cases being traceable to want of knowledge on the part of trainmen in regard to the system of heating. A short time since passengers were subjected to annoyance, due to the fact that lamps in a coach could not be lighted, on account, as was claimed by the trainmen, of not having been trimmed. Investigation showed that the trainmen on that particular train did not understand how to adjust the lamps in order to get the oil to feed properly.

On the other hand numerous cases could be mentioned where trainmen, by their knowledge and vigilance, have detected defective cars, which if allowed to run would have caused serious wrecks. This paper, however, is not intended to disparage trainmen and it is therefore not necessary to cite cases in their favor.

To thoroughly understand the importance, to a railway, of dispatch, safety and comfort, it is really necessary to place oneself in the position of that of the car service agent, the freight claim agent and the general passenger or freight agent.

Assuming, however, that the necessity for instructing trainmen has been clearly shown, the next question is in what manner should this be done. There are several ways, but the most effectual would appear to be to establish a rule that brake-

inghouse Machine Company; the Westinghouse Air Brake Company will equip the rolling stock; and all electrical apparatus will be supplied by the Westinghouse Electrical and Manufacturing Company. The electric installation is to comprize 1000 horse power of dynamos and motors. The station when completed will be the finest in the country. Electricity will be used for lighting, for driving pumps, ventilating fans, etc.

TEN-WHEEL LOCOMOTIVE--WISCONSIN CENTRAL LINES.

It seems most opportune to present at this time quite complete detail drawings of the ten-wheel locomotives which were built early in the present year for the Wisconsin Central Lines, by the Brooks' Locomotive Works, from the designs of Mr. Jas. McNaughton, superintendent of motive power and cars of that system. The order was for four locomotives with cylinders 19x26 inches, and 69-inch driving wheels, for passenger service, and six with cylinders 20x26 inches and 63-inch driving wheels, for freight service. Except such differences as were made necessary by the difference in cylinders and driving wheels, the two classes are alike and the drawings and description of one will serve for both. The general dimensions are appended, and by a study of them and of our illustrations it will be un-

reverse lever fulcrum bracket is bolted to the underside of the running board.

The equalizing arrangement is interesting; that part carrying the weight on the two hack driving boxes terminates in elliptic springs instead of the usual coil spring. This should affect advantageously the riding of the locomotive. The two front driv-

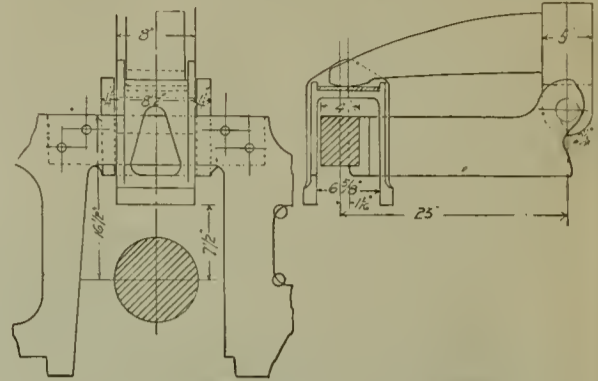

WISCONSIN CENTRAL LOCOMOTIVE DRIVER SPRING ARRANGEMENT.

ing boxes, one on each side, are connected by a spring of the ordinary driving spring form; its ends rest on top of the driving boxes and the weight of the frames and parts above are transmitted to the center of the spring by means of a crossbar. This

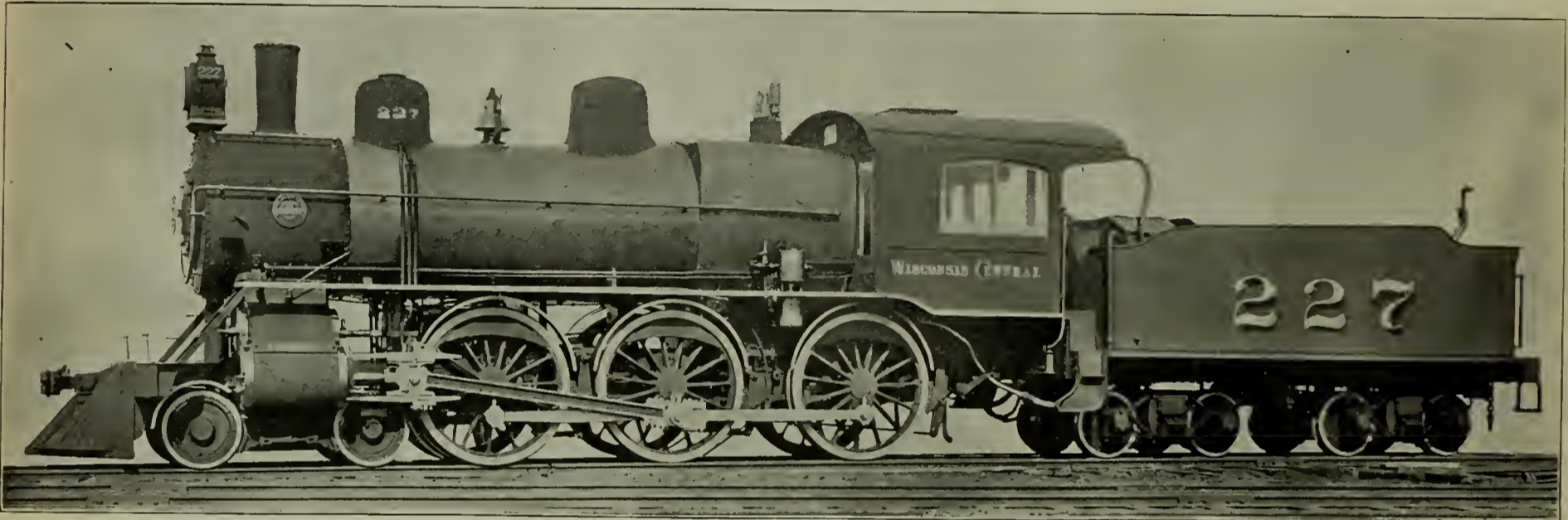

TEN WHEEL PASSENGER LOCOMOTIVE--WISCONSIN CENTRAL RY.

men should not be eligible for promotion until they can pass an examination on the following subjects:

- Hot boxes—cause and treatment.
- Draft rigging, various parts, relation one part to the other.
- Trucks—various parts.
- Air brakes—elementary.
- System of lighting and heating.

Educate trainmen to this extent and the result will be that the traveling public will be saved many petty annoyances, the movement of freight will be expedited, fewer wrecks will occur (for the reason that trainmen will then be competent to inspect for safety) and the work of car inspectors and repairers will be greatly facilitated by the intelligent manner in which defects are reported.

In order to assist the men in acquiring this knowledge, a good print showing the anatomy of a car, and also instructions regarding air brakes and the system of lighting and heating, should be hung in cabooses or baggage cars, as the circumstances may warrant. In addition the equipment of a caboose should include hrasses (solid being preferable to filled shell for caboose purposes), air hose, two knuckles and spindles and spindle keys.

In conclusion the writer wishes it understood he does not advocate trainmen making car repairs in the proper sense of the word, or that they should relieve car men of any responsibility, but that trainmen be instructed to such an extent that they will be capable of rendering better service in the matter of keeping freight moving, etc.

The new Southern terminal railway station at Boston is a good illustration of the scope of the Westinghouse manufactures. The switches and signal system are to be provided by the Union Switch & Signal Company; the engines by the West-

derstood that the locomotives are entirely worthy the attention which many are giving them.

Perhaps the piston valve will attract first attention, partly because considerable general interest is now taken in piston valves. The cross section of the cylinder casting and the details of the valve packing rings will be readily understood and it is necessary only to direct attention to them. The frames are of somewhat unusual construction, due partly to the shape of the cylinder casting necessitated when piston valves are used. With the combination of piston valves, simple cylinders, steam passages as direct as possible, and the desired neat exterior appearance it is difficult to use the two-bar front end frame; as an off-set to this the front

spring interferes somewhat with the valve rod so an off-set was necessary in that member. Such off-sets in the valve motion parts are generally objectionable, unless, as seems to be the case here, the part is made exceptionally heavy. Apparently, also, advantage was taken of the general impression that piston valves are well balanced and the connections therefore less liable to spring from line.

It will be observed that the crown sheet as well as the fire-box sheet, slopes backward, a practice that has been followed in several new designs to reduce the weight at the hack end. The driving wheels are of cast steel and the journals are, main 9x11 inches, front and back 8½x11 inches. More attention seems to have been given to the ash-pan

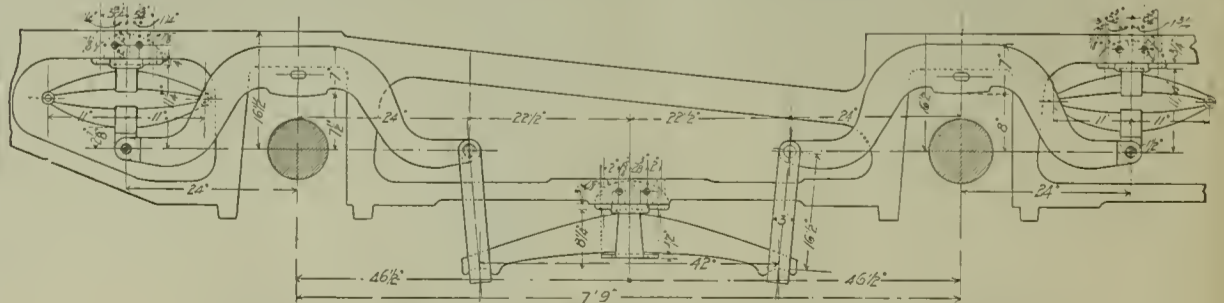

WISCONSIN CENTRAL LOCOMOTIVE--DRIVER SPRING ARRANGEMENT.

frames of these locomotives are 10 inches deep and 3 inches wide, and this gives a very good opportunity for rigid connection with the cylinder. The back end of the frame is 10 inches deep by 1½ inches thick.

The cab floor drops down several inches back of the rear driver, giving more head room in the cab and being easier of access from the deck floor. The

in this locomotive than is generally the case, and the ash-pan arrangement will receive at our hands future notice, together with more detailed drawings. The general dimensions of this engine are as follows:

GENERAL DESCRIPTION.

Type.....10-wheel passenger--10-wheel freight.  
Name of builder.....Brooks Locomotive Works.

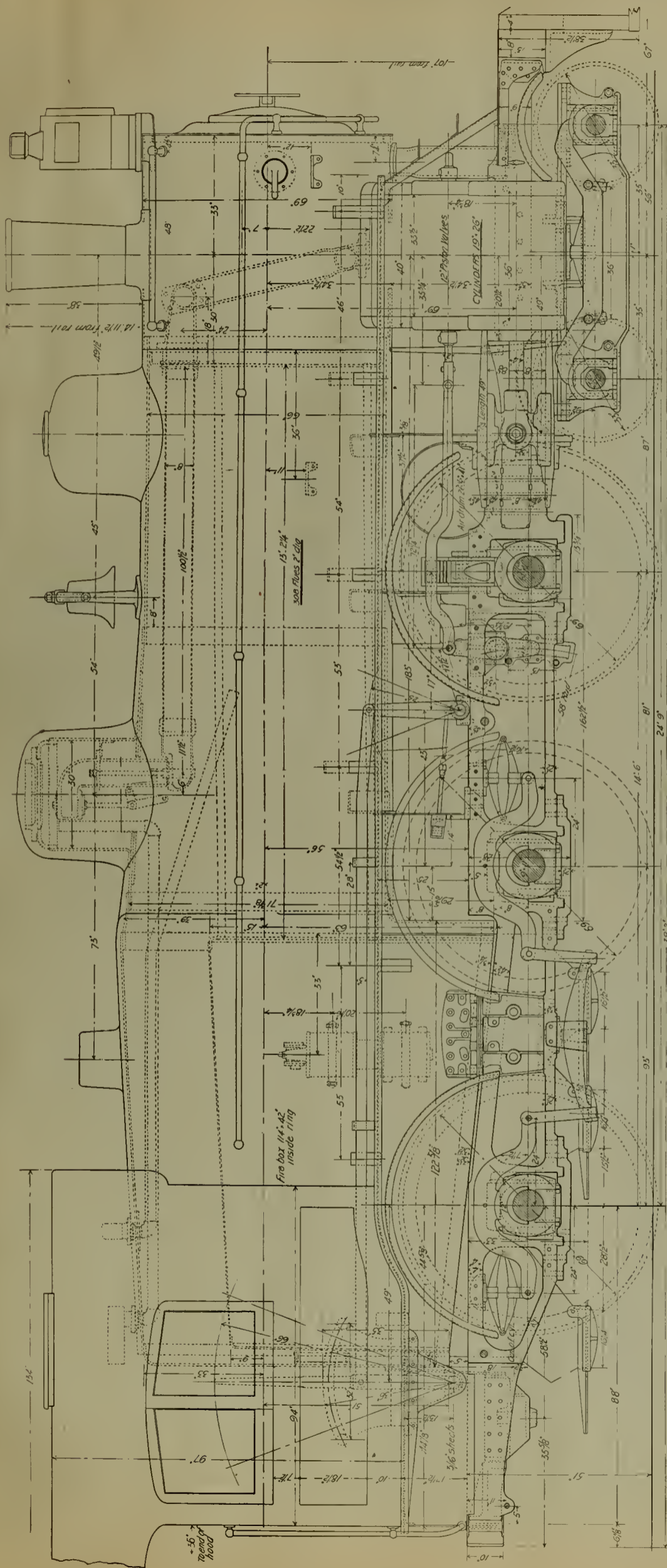

TEN WHEEL PASSENGER LOCOMOTIVE—WISCONSIN CENTRAL, RY.

Name of operating road.....Wisconsin Central Lines.  
 How many and dates of delivery.....  
 .....Four, Feb., 1898.; six, Feb., 1898.  
 Gauge.....4 ft. 8½ in.  
 Kind of fuel to be used.....Bituminous coal.  
 Weight on drivers.....passenger, 116,000 lbs.  
 .....freight, 115,000 lbs.  
 Weight on trucks.....passenger, 34,000 lbs.  
 .....freight, 34,000 lbs.  
 Weight, total.....passenger, 150,000 lbs.  
 .....freight, 149,000 lbs.  
 Average.....75,000 lbs.  
 Weight tender loaded maximum.....94,000 lbs.

GENERAL DIMENSIONS.

Wheel base, total, of engine.....24 ft. 9 in.  
 Wheel base, driving.....14 ft. 6 in.  
 Wheel base, total (engine and tender).....52 ft. 2 in.  
 Length over all, engine.....38 ft. 2 in.  
 Length over all, total, engine and tender.....62 ft. 6 in.  
 Height center of boiler above rails, 8 ft. 11 in.; 8 ft. 8 in.  
 Height of stack above rails. 14 ft. 11½ in.; 14 ft. 8½ in.  
 Heating surface, firebox and arch pipes.....189 sq. ft.  
 Heating surface, tubes.....2111 sq. ft.  
 Heating surface, total.....2300 sq. ft.  
 Grate area.....32.4 sq. ft.

WHEELS AND JOURNALS.

Drivers, number.....Six.  
 Drivers, diameter.....passenger, 69 in.; freight, 63 in.  
 Drivers, material of centers.....Cast steel.  
 Truck wheels, dia.....33 in.  
 Journals, driving axle, main.....9x11 in.  
 Journals, driving axle, front and back.....8½x11 in.  
 Journals, truck.....5½x12 in.  
 Main crank pin, size.....6¼x6 in.

CYLINDERS.

Cylinders, dia.....passenger, 19 in.; freight, 20 in.  
 Piston, stroke.....passenger, 26 in.; freight, 26 in.  
 Piston rod, diameter.....4 in.  
 Kind of piston rod packing.....Jerome.  
 Main rod, length center to center.....119 in.  
 Steam ports, length.....18 in.  
 Area.....36 sq. in.  
 Steam ports, width.....2 in.  
 Exhaust ports, length.....56 in.  
 Least area.....65.5 sq. in.  
 Bridge, width.....2½ in.

VALVES.

Valves, kind of.....  
 .....Improved piston with internal admission.  
 Valves, greatest travel.....7 in.  
 Valves, steam lap (inside).....1½ in.  
 Valves, exhaust lap or clearance (outside).....  
 .....½ in. clearance.  
 Lead in full gear.....1-16 in.  
 Valves, lead constant or variable.....Variable.

BOILER.

Boiler, type of.....  
 .....Belpaire conical connection with wagon top.  
 Boiler, working steam pressure.....200 lbs.  
 Boiler, material in barrel.....Steel.  
 Boiler, thickness of material in barrel.....⅝ in.  
 Boiler, thickness of tube sheet.....¾ in.  
 Boiler, diameter of barrel.....66 in.  
 Seams, kind of horizontal.....Quintuple.  
 Seams, kind of circumferential.....Double.  
 Crown sheet stayed with.....Radial stays.  
 Dome, diameter.....30 in.

FIREBOX.

Firebox, type.....Sloping, over frames.  
 Firebox, length.....113 in.  
 Firebox, width.....41¾ in.  
 Firebox, depth, front.....78 in.  
 Firebox, depth, back.....60 in.  
 Firebox, material.....Steel.  
 Firebox, thickness of sheets.....  
 .....Side, 5-16 in.; crown and back, ⅜ in.; tube, ⅝ in.  
 Firebox, brick arch.....On water tubes.  
 Firebox, mud ring, width.....  
 .....Back, 3½ in.; sides, 3½ in.; front, 4 in.  
 Firebox, water space at top.....  
 .....Back, 4½ in.; sides, 5 in.; front, 4 in.  
 Grate, kind of.....Rocking.  
 Tubes, number of.....308.  
 Tubes, material.....Charcoal iron.  
 Tubes, outside diameter.....2 in.  
 Tubes, thickness.....No. 12 B. W. G.  
 Tubes, length over tube sheets.....13 ft. 2¼ in.

SMOKE BOX.

Smoke box, diameter outside.....69 in.  
 Smoke box, length from flue sheet.....63 in.

OTHER PARTS.

Exhaust nozzle, single or double.....Single.  
 Exhaust nozzle, variable or permanent.....Permanent.  
 Exhaust nozzle, diameter.....4⅞ in., 5 in., 5½ in.  
 Exhaust nozzle, distance of tip above center of  
 boiler.....1 in.  
 Netting, wire or plate.....Wire, No. 12.  
 Netting, size of mesh or perforation.....2½x2½ in.  
 Stack, straight or taper.....Taper.  
 Stack, least diameter.....15⅞ in.  
 Stack, greatest diameter.....18⅞ in.  
 Stack, height above smoke box.....38 in.

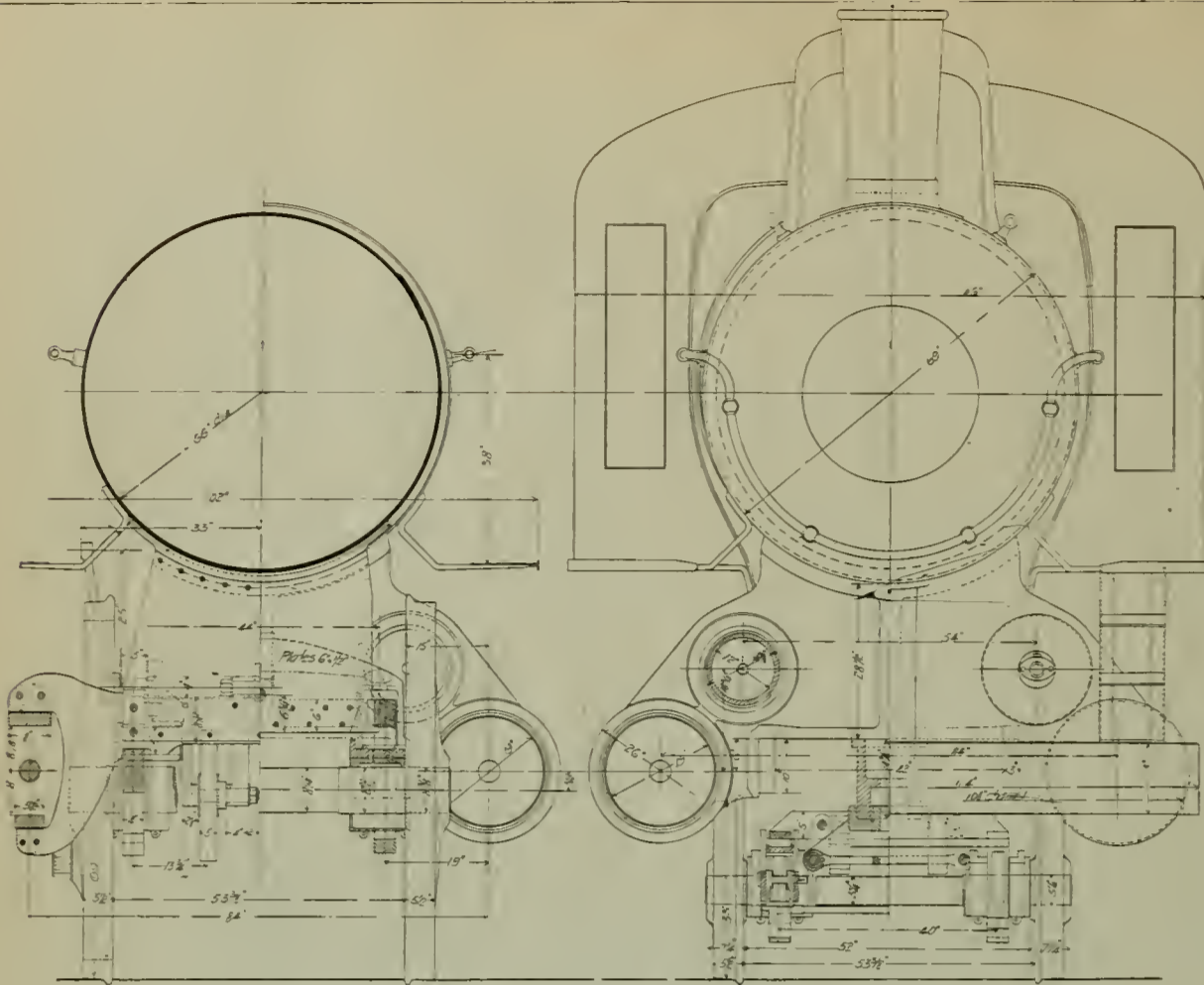

WISCONSIN CENTRAL LOCOMOTIVE—CROSS SECTIONS.

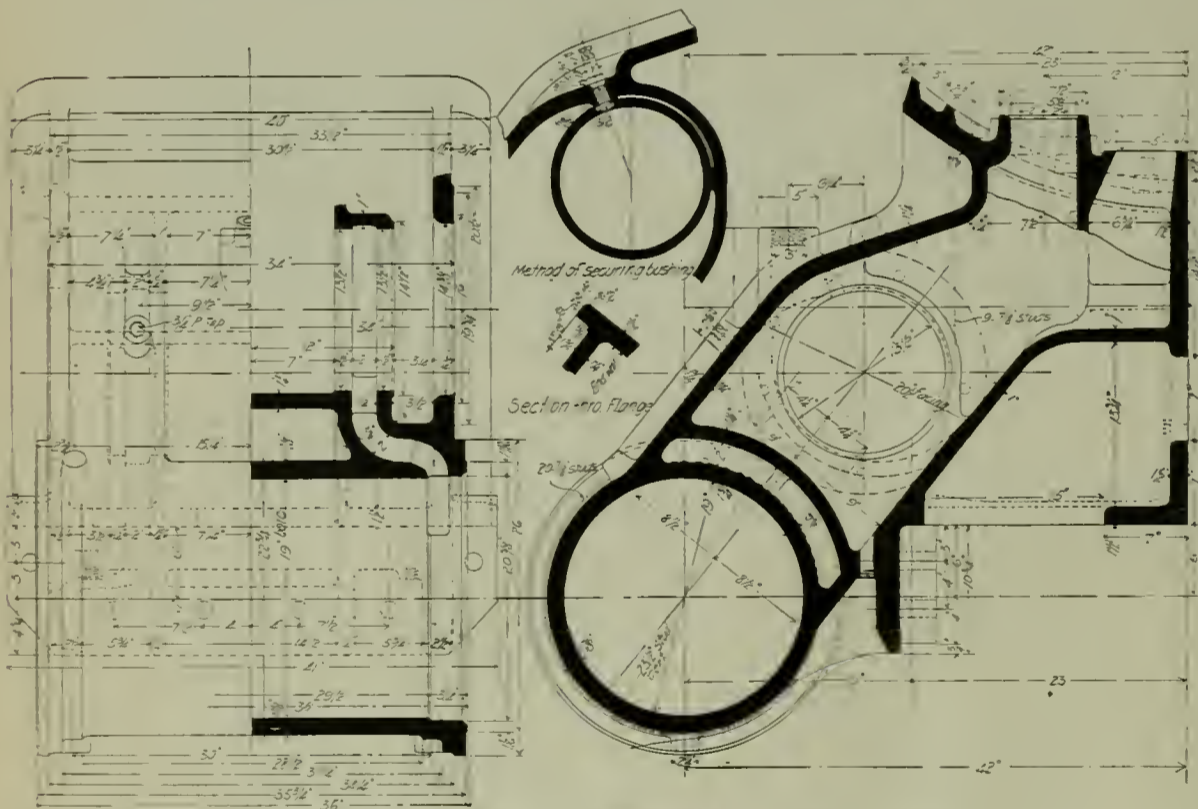

WISCONSIN CENTRAL LOCOMOTIVE—CYLINDER CASTING.

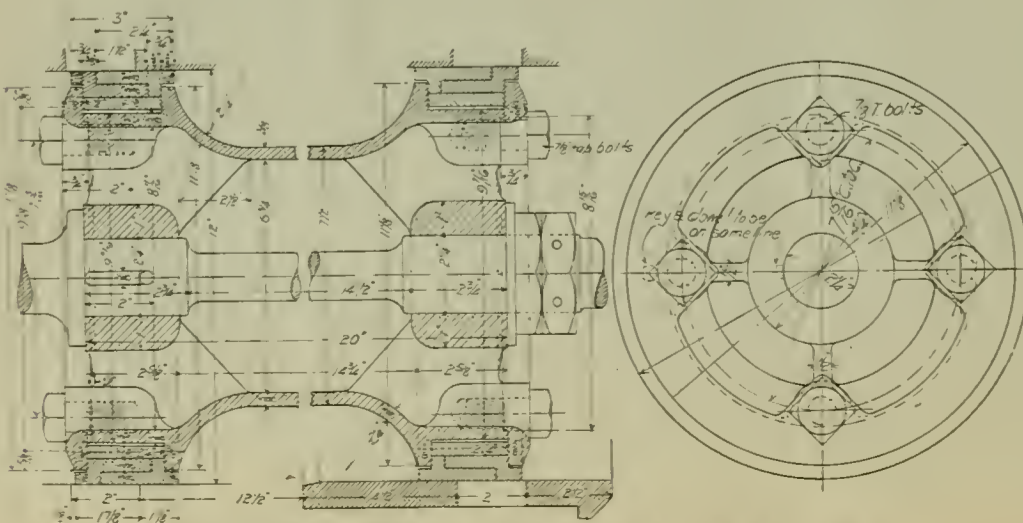

WISCONSIN CENTRAL LOCOMOTIVE—PISTON VALVE.

TENDER.

Type.....Eight-wheeled, steel frame.  
 Tank, type....."U" shape.  
 Tank, capacity for water.....4500 gals.  
 Tank, capacity for coal.....8 tons.  
 Tank, material.....Steel.  
 Tank, thickness of sheets.....3-16x1/4 in.  
 Type of under frame.....Steel channel.  
 Type of springs.....1/2 elliptical.  
 Diameter of wheels.....33 in.  
 Diameter and length of journals.....4 1/4 x 8 in.  
 Distance between centers of journals.....6 ft. 3 in.  
 Diameter of wheel fit on axle.....5 3/8 in.  
 Diameter of center of axle.....4 3/4 in.  
 Length of tender over bumper beams.....22 ft. 4 in.  
 Length of tank.....19 ft. 6 in.  
 Width of tank.....9 ft. 10 in.  
 Height of tank, not including collar.....3 ft. 10 in.  
 Type of draw gear.....M. C. B. Standard.

SPECIAL EQUIPMENT.

Brakes...Westinghouse-American for engine, tender and train service.....  
 Pump.....9 1/2 in. Westinghouse.  
 Bell ringer.....Go'mar.  
 Sight feed lubricators.....passenger, Michigan, freight, Nathan.  
 Safety valves.....Crosby.  
 Injectors...Hancock No. 8, Monitor No. 9 and.....Metropolitan No. 8.  
 Springs.....A. French Spring Co.  
 Metallic pack'n.....Jerome.  
 Blow-off cock.....McIntosh.  
 Tires.....Krupp.

THE TESTING LABORATORIES OF THE GALENA OIL COMPANY AT FRANKLIN, PA.

When the president of the Galena Oil Company, Hon. Charles Miller, decided to have a new chemical and physical laboratory built up, he expressed a desire to have it in every respect first-class, and second to none in this country. The realization of this ambitious design is found in the lately completed equipment, and a short description of this very elaborate and handsomely furnished department will be of general interest.

The former chemical laboratory was located at the works of the company in Franklin, but as the business of the company has grown enormously within the last few years, the importance of the work of the bureau of tests and lubrication has increased in proportion. As there was not sufficient available space at the works for the erection of a new laboratory building of the size needed, a very suitable brick building was obtained located next to the company's general offices and facing the beautiful city park of Franklin. The new laboratories occupy the whole second story of this building, having a floor space of 132 ft. in length and 35 ft. in width, conveniently divided into rooms for the various laboratory uses. The accompanying diagram of the floor plan shows the several rooms, their size, and the general purposes for which they are used.

Library and General Office.

The first room entered from the hall on the second floor is the library and general office. This office is 20' 11"x10' 2". It is provided with tables, book cases, book shelves, and cases for chemical glassware and apparatus, and is abundantly lighted with electric lights. The book cases are well filled with scientific books and periodicals.

Main Chemical Room.

The next room to the left of the library is the main chemical room, the size of which is 34' 9"x13' 6". This large room has four windows, all facing the beautiful city park, and from these windows there is obtainable, in the far background, a fine view of Point Hill, from which all the heavy Franklin oil is obtained. This is known as the "heavy oil Franklin district" which produces the wonderful Franklin natural mineral oil, from which the celebrated Galena lubricating oils are compounded.

This room (see figs. 1, 2 and 3) is fitted out abundantly with chemical tables and hoods, with all kinds of chemical apparatus of the latest and best designs, and with water and steam connections. The main chemical table, shown in figure 2, is of wood and has a hardwood top. It is provided with shelves, containing the various chemical solutions; with a lead-lined sink and central lead-lined gutter to carry off water from the filter; with suction pumps and gas, water, and air suction and blast connections with nickel plated pipes and valves. The bottles containing the various chemical solutions are spe-

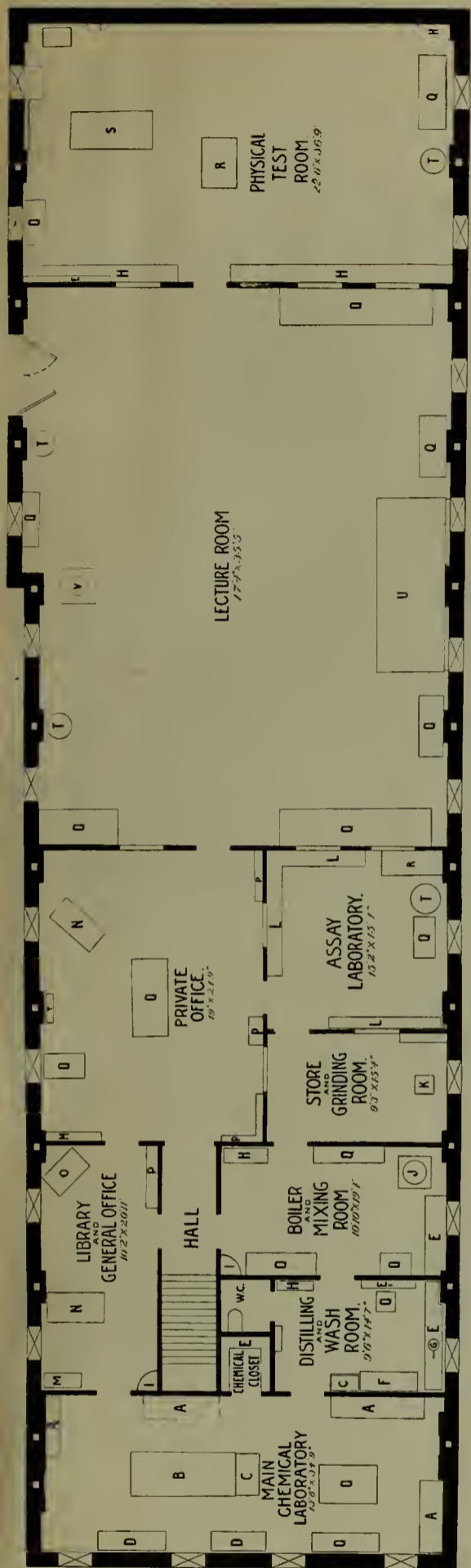

TESTING LABORATORY OF THE GALENA OIL CO., AT FRANKLIN, PA.—FLOOR PLAN.

- KEY.
- A—Hoods.
  - B—Main chemical table.
  - C—Sinks.
  - D—Chemical tables.
  - E—Shelves.
  - F—Washing table.
  - G—Still.
  - H—Closet.
  - I—Wash stands.
  - J—Boiler.
  - K—Engine.
  - L—Chemical table and shelves.
  - M—Book case.
  - N—Desk.
  - O—Apparatus closet.
  - P—Book shelves.
  - Q—Table.
  - R—Electric motor.
  - S—Testing machine.
  - T—Stove.
  - U—Platform.
  - V—Stereopticon.



FIG. 1.—GALENA LABORATORY—MAIN CHEMICAL ROOM.

cial importations, of the best glass, provided with cut glass stoppers.

The various hoods for carrying off strong fumes and obnoxious gases, as well as the hoods containing special apparatus, are constructed principally of glass, of the best and most improved design. They are provided either with purple slate tops, or with wooden tops covered with heavy sheet lead, the backs being lined with porcelain tile.

Some of these hoods for certain work are provided with steam baths and water and gas connections, as shown in the photographic views. Several of these contain air, water and oil baths for drying and heating, with oil testing apparatus for taking flash and fire points, viscosity, capillarity, etc. In

this room is also found a large array of chemical apparatus specially designed for the work.

The general appearance of this complete and well arranged laboratory room is a very agreeable surprise. Its fine and elegant furnishings, the brightly diffused daylight, and the brilliant artificial light at night, make it a most attractive place in which to work. Connected with it is a well stocked chemical closet, containing all necessary chemicals and chemical solutions for analytical work of every kind or description.

**Distilling and Wash Room.**

The next room adjoining the main chemical room is the distilling and wash room (see fig. 4), which is 14' 7" x 9' 6" in size. This room contains lead-lined



FIG. 2.—GALENA LABORATORY—MAIN CHEMICAL ROOM.

tables and lead-lined sinks, and is used for cleaning and washing out glassware and chemical apparatus. The sink is provided with hot and cold water and an air suction pump. Besides this there is also a small hood connected directly with a strong draft chimney to carry off poisonous and other fumes and gases. This room also contains a steam distilling apparatus for making chemically pure water, and a very complete sulphuretted hydrogen gas apparatus.

#### Boiler and Mixing Room.

The next room adjoining is 19' 4"x10' 10" in size, and containing a steam boiler for the laboratory use. In this room the experimental compounding of oils is done. The apparatus shown in the background of the photographic view (see Fig. 5) is specially designed for testing valve and cylinder oils at high temperatures by means of super-heated steam or air.

#### Store-Room.

Beyond this is the store room 15' 4"x9' 3" in size, provided with shelves for storing samples of oil and other materials, also for keeping grinding machinery in connection with the adjoining assay room.

#### Assay Laboratory.

The next room (see fig. 6) is the combustion and assay room, size 15' 2"x15' 4". This is equipped with assay furnaces, organic combustion furnaces and apparatus, electrical experimental apparatus, such as induction spark coils, ozone generators, small electric motor, air blast pump, etc.

#### Private Office.

Beyond the library and general office is the private office of the chief of the bureau (see Fig. 7). From the floor plan it will be seen that it can be entered directly either from the hall, the assay room, or the outer office or library. This spacious room, which is 24' 9"x19' in dimensions, is finished in natural wood and is well lighted by several windows and provided with both incandescent and gas lights. With its well filled book cases and book shelves, tables, office desk and rich carpet, it is a beautiful and attractive office.

#### Lecture Room.

In the rear of the private office and assay room, as shown on the floor plan, is a large hall, 47' 5"x34' 4". This is used as a lecture room, and is provided with platform, blackboards, a large number of chairs, and other furniture required for scientific and technical assemblies. In this room are held the quarterly or semi-annual meetings of the mechanical experts of the company.

#### Physical Test Room.

Adjoining the lecture room, and at the opposite end of the building from the main chemical room, is the physical test room, a large, airy and pleasant apartment, 36' 9"x22' 6" in size. In this room are the oil and brass testing machines, drawing-tables, lubricating devices, etc. (See Fig. 8.)

All these rooms are well ventilated, well lighted, have high ceilings and are heated by means of natural gas; the floors are covered with heavy linoleum or carpet when the latter is more suitable, and the walls and ceilings are carefully finished in natural wood, papered, or painted.

#### Oil Testing Machine.

The large oil testing machine shown in the photographic views (Figs. 8, 9 and 10) has just been completed.

Realizing the great change of the last ten years in the cars and motive power used upon American railways, with the constantly recurring demand for more weight and higher speed, the president of the company, Hon. Charles Miller, has, in connection with the building and fitting out of these complete laboratories, had this new oil testing machine specially constructed in accordance with his ideas, his desire being to make not alone theoretical, but practical, demonstrations of the value of the Galena lubricants. After an exhaustive study of existing oil testing machines in this country and Europe, it was found advisable, in order to carry out his wishes, to have something more completely adapted to its purpose than anything hitherto known. This machine, containing novel features and improvements, was then built from original designs to conform to the ideas and principles evolved from theory and practical experience. The machine is intended to make practical tests under conditions as near as possible to those found in actual service on railroads. It is so arranged as to have not alone rotary motion but lateral motion as well, with pressure upon the journals beyond any present requirements and at speed beyond any present attainments,



FIG. 3.—GALENA LABORATORY—MAIN CHEMICAL ROOM.



FIG. 6.—GALENA LABORATORY—ASSAY ROOM.

and to meet all conditions of climate, whether of the arctic or tropic regions.

It is constructed in such a way that full sized car journals can be inserted, as well as M. C. B. car boxes; the test journals to the machine are  $4\frac{1}{4} \times 8$  in. and  $5 \times 9$  in., the largest M. C. B. sizes. By means of a leverage, screw and spring balance system, varying loads, from nothing up to 20,000 lbs., can be applied at will on the journal while the machine is running at any desired speed up to its maximum speed.

The machine is provided with a very complete and ingenious leverage and balancing system of automatic and autographic measuring and weighing, for recording the frictional power exerted on the journal during the test, direct in pounds. This is done in much the same way as the scale or weighing beams are arranged and constructed on tensile test and compressing test machines, provided with automatic and autographic recording devices.

These automatic and autographic measuring and weighing arrangements are constructed in such a way that although two different diameters of journals ( $4\frac{1}{4}$  and 5 in.) are used as standards, the same scale beam arrangement can be used giving the friction in pounds direct in either case without further calculation. This of course is very convenient and one of the prominent features of this new machine.

Further, the machine is provided with a device to record temperatures of the brass during the test, which can be placed on the same paper as the autographic friction recording arrangement. It is also provided with a tachometer to show the speed of the machine at any and all times during the test, besides a recording revolution counter, showing the total number of revolutions during the whole test or part thereof. This machine is put on a solid stone and brick foundation, built up direct from the cellar of the building to and above the second floor on which it stands.

Besides the full-sized test journals, some times used, there are also provided axles or spindles having a tapered journal, for which sleeves of desired sizes and materials are provided. Figure 11 clearly shows the various sized sleeves and test brasses. This arrangement is very desirable as well as economical. The test brasses are made of various compositions and provided with water ways in the interior so that either hot or cold water can be run through the brass at will during the test.

The machine is further constructed in such a way that a full sized ( $5 \times 9$  in.) journal, with an M. C. B. car box can be inserted, used and packed as in actual service. When the car box is used a regular M. C. B. standard brass is also employed.

The overhead arrangement as shown by figure 8, including clutch-pulleys, belting, shafting, etc., consists principally of a set of variable speed cones, constructed in such a way that having the main shaft running at a constant speed of, say, 600 revolutions, the speed of the machine can be increased or decreased at will without stopping, from the slowest to the maximum speed. It may be added that the machine is constructed to be run in either direction so as to make duplicate tests both ways.

The machine was built by Tinius Olsen & Company, testing machine manufacturers, Philadelphia, Penn. It is most substantially made, and all the machine work is done in an extra superior finish, highly polished and heavily nickel-plated. The frame work and foundation are finished in black enamel. The motive power used is a 15 h. p., electric motor built by the General Electric Company of Schenectady, N. Y.

There are many details, devices and designs used in the construction of this oil testing machine, which cannot be described here, except at too great length, but any one who is specially interested has a cordial invitation to visit Franklin and inspect the same at any time.

On the photographic view (see Fig. 8) showing the general arrangements of the physical test room is also shown a small oil testing machine, formerly used by the company. The difference in the size of these two machines is a good illustration of the enormous growth of the company's business, and of the difference between the old chemical laboratory and the new and spacious quarters of the elegant and most complete testing laboratories of their kind in this country.

In our views are shown many interesting pieces of apparatus used in examination and investiga-



FIG. 4.—GALENA LABORATORY—DISTILLING ROOM.

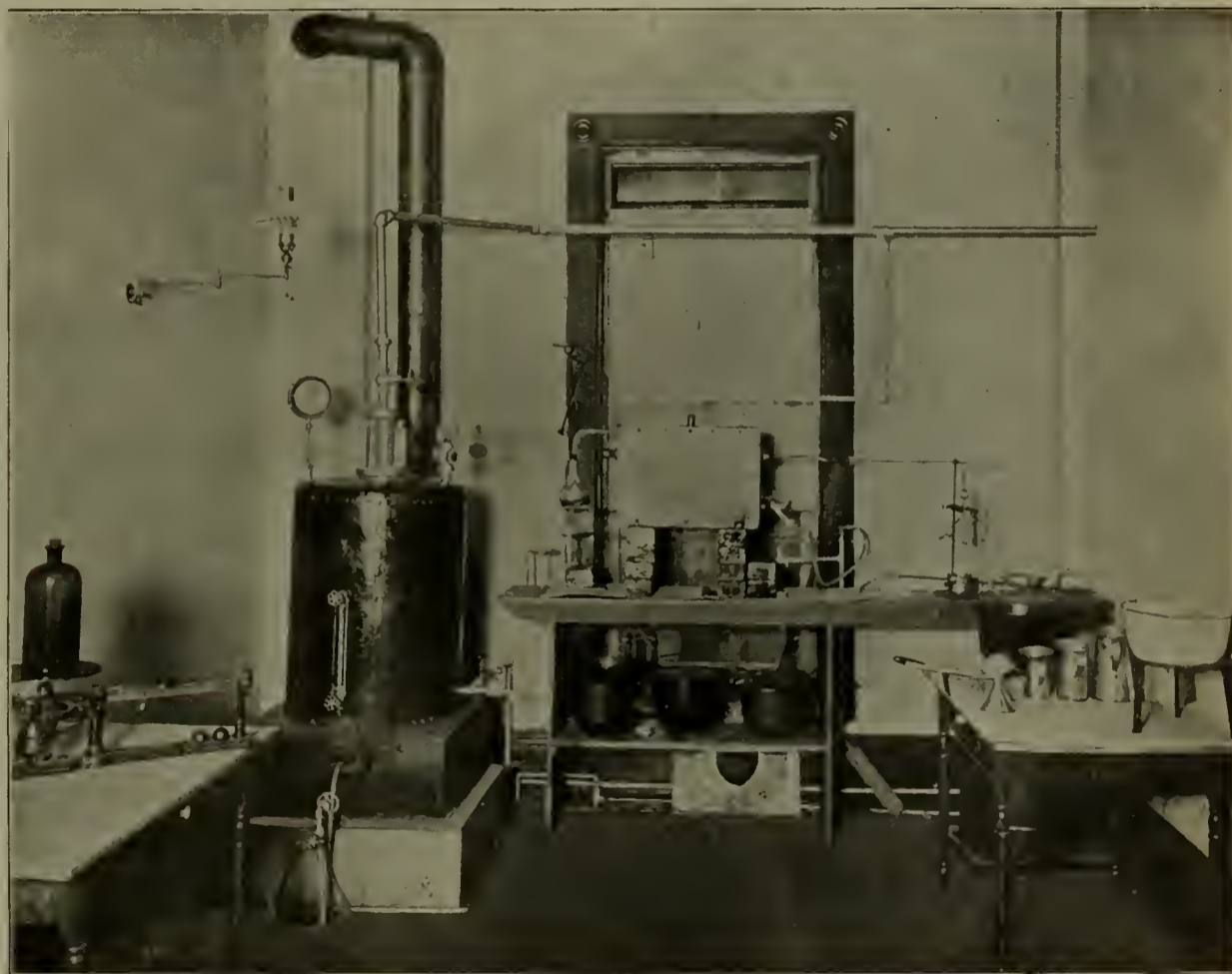

FIG. 5.—GALENA LABORATORY—BOILER ROOM.

tions of oils and materials entering into the compounding of the Galena oils, valve oil and signal oil. One of these views (see Fig. 12) shows a number of viscosimeters of different designs and principles to measure or determine the so-called viscosity, or body, of lubricating oils and other liquids. Another view (see Fig. 1) shows microscopic outfits, photomicro apparatus for the study and investigation of oils and bearing metals, and apparatus for the chemical-electrical examination of brasses, babbitts, etc.

The arrangement and fittings, tables and hoods,

and much of the apparatus are all from designs of the Chief of the Bureau, P. H. Conradsou.

#### Scope of Work.

The testing work consists largely in the examination of the various materials entering into the compounding of oils before shipping. Scientific and technical aid is also given in the various processes involved in the manufacture of the various oils.

In experiment and investigation of the various complicated problems of railroad lubrication (including oils, brasses, journals, waste, etc.), the work

is undertaken not only for the direct benefit of the company, but also for the general and individual benefit of the railroads of the country who are cordially invited to avail themselves of this expert scientific department.

While the above descriptions give a fair idea of the size and number of the various rooms and their fittings, a personal visit is necessary in order to fully appreciate the completeness of this laboratory.

**Department Organization.**

The present personal force of this important department, or as it is called, the "bureau of tests and

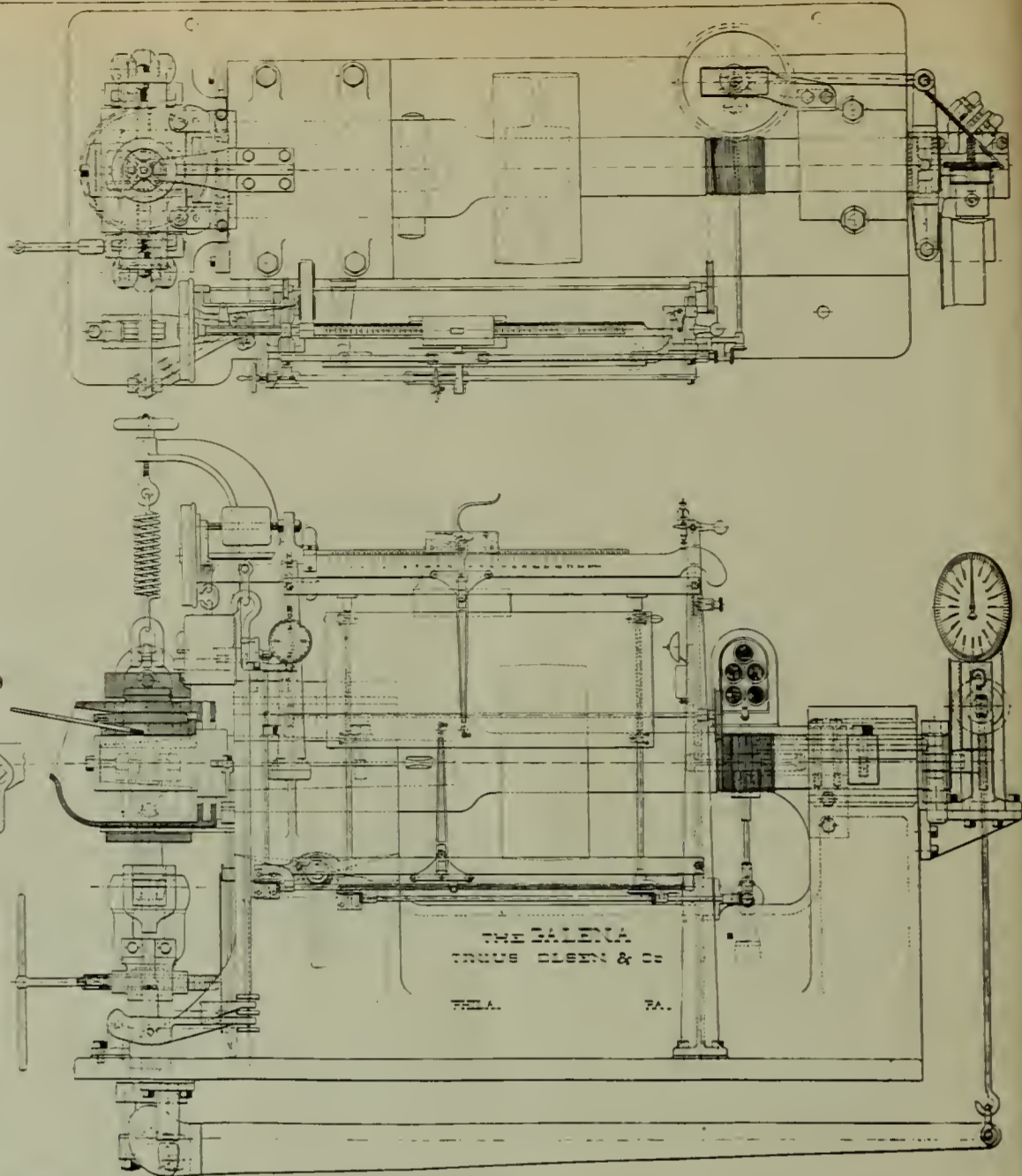

FIG. 10.—GALENA LABORATORY—OIL TESTING MACHINE.

lubrication," with its two branches, chemical and physical is as follows: Chief of the Bureau, P. H. Conradson, Phm. C. D., Member American Chemical Society, American Institute of Mining Engineers, Society of Chemical Industry, London, England, The Northwest Railway Club, etc., and his chief assistants in the respective chemical and physical departments—P. Oppenheim, mechanical engineer and Charles Hamilton, chemical amannensis.

Dr. Conradson, who has had direct charge of the creation of this important adjunct to the work of the Galena Oil Company, is particularly well qualified, both by education and practical experience, for the work. He was for four years assistant to Dr. C. B. Dudley, the well known chief chemist of the Pennsylvania railroad system at the Altoona laboratories, and left that post to build up the test department of the New York & New England R. R., where he had an exceptionally good opportunity to study the problems of railroad lubrication. The road built and operated very successfully a brass foundry at his recommendation and under his supervision, which gave him an extended experience in the art of making brasses, followed up with actual results in service. While with this road he first became acquainted with the Galena oils, and soon found them superior to other lubricating oils in the market. He was for six years Chief of the Bureau of Tests of the Great Northern Ry. system at St. Paul, a department which he organized and brought to a high degree of efficiency. A more perfect training than this long and varied experience in railroad work could not be desired for supervising the chemical and physical fitness of lubricating oils used on 95 per cent of the railroads in the United States, Canada and Mexico.

The laboratories at Franklin, easily the completest and best equipped attached to any commercial institution in the country, are another monument to the intelligence and far-sightedness of General Miller, the well known president of the Galena Oil Company.

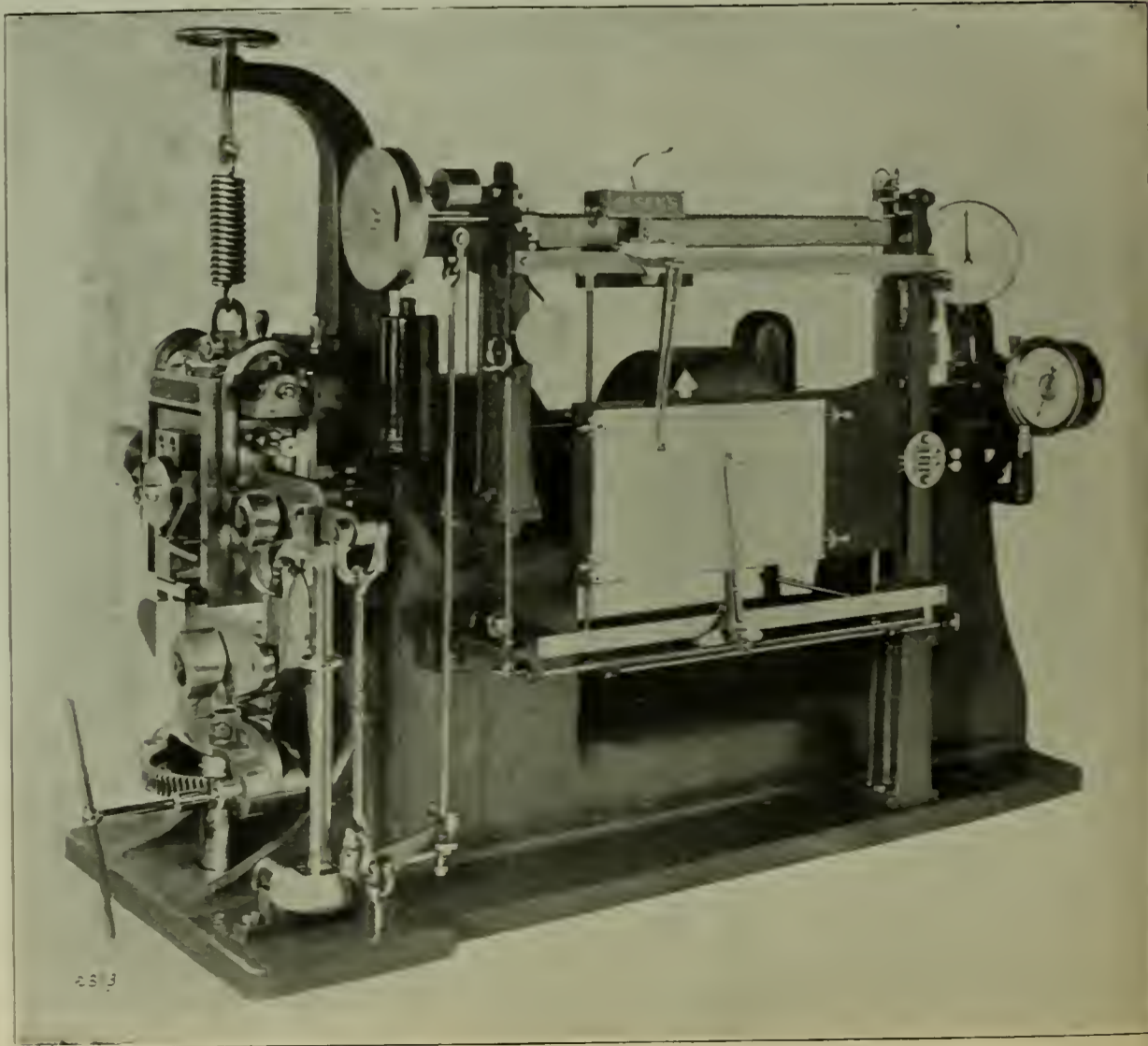

FIG. 9.—GALENA LABORATORY.—OIL TESTING MACHINE.



**CAR COUPLER INVENTIONS AND PATENT POINTS.**

The inventive faculty has been especially fertile in the coupler field—so much so, that minute classification has taken place. But though many inventions have been offered to the public, few have been chosen. The vast majority have been found to be impracticable. The want, indeed, was a difficult one to fill. It required a coupler which could be depended upon to automatically lock with precision and certainty when the cars came together; which could be easily and instantly unlocked from the side of the car; which would remain locked under all the various movements and strains to which it was exposed; which would relieve the shock of contact without sacrificing the stability of the lock or impairing it; and which would be simple in its construction and inevitable in its operation, and hold until intentionally released.

Thus did Judge Grosscup sum up the situation, in delivering the opinion of the United States circuit court, in the recent case of the Hinson Manufacturing Company against Williams, where suit was brought to restrain the infringement of letters patent No. 389,510, issued to James A. Hinson, for "improvements in car couplers," the device falling within what is known as the "Twin Jaw," or "Janney" class. The advance claimed for this patent over its predecessors resides in the effect produced by a hollow offset, cast integral with the drawbar, forming a shoulder to abut against the front beam of the car when the drawbar is driven back, and a spiral spring in the offset and resting upon the shoulder to throw the latch forward, or into its normal position, again, when the same is released. The conclusion reached is that the combination in question is a true mechanical organization, including features that are a patentable advance upon the preceding art, and that the patent covering the same was being infringed by the defendant's car coupler, which is said to be almost an exact copy of the coupler described in this patent.



FIG. 7.—GALENA LABORATORY—PRIVATE OFFICE.

Judge Grosscup admits that the recess is found, in some degree, in some of the preceding patents, and, also, that, in some of the previous patents, a spring has been used to reinforce gravity. But he declares that no patent called to his attention discloses such recess, spring, and latch, in the same relation to

each other, as the patent under consideration embodies.

This leads him to make some further very interesting observations. Success or failure in mechanical devices, requiring such nice adjustment, and subjected to so many contrary influences, he says, may depend upon some apparently trifling alteration in the structure; but, if the required alteration has gone unheeded, through years of constant demand for its disclosure, he goes on to state that he can see no reason why the person fortunate enough to finally hit upon it should not be given the benefits of an inventor. Retrospectively, the alteration may seem simple, such as any mechanic would have suggested; but the fact remains that, prospectively, it remained, even in the face of a strong demand, securely concealed.

The court that, after the fact, pronounces such an alteration, under such circumstances, too simple to be invention, Judge Grosscup boldly affirms, mistakenly sets its own powers of apprehension above the apprehension of the whole of that portion of the inventive world that has been, for so long a time, giving its attention to the want in hand.

**Impracticable Rules for Employees.**

Concerning a rule enjoining upon employees to examine and know the kind and condition of the drawhead, drawbar, link and coupling apparatus before making couplings, and forbidding coupling by hand in all cases when a stick or proper implement can be used to guide the link, the Supreme court of California says that if the rule was utterly impracticable, or rendered so by the mode and conditions under which service was required, and an employee was injured because not following an impracticable rule, and could not, therefore, maintain an action for damages, then the rule was plainly not for the protection of the employee, but of the employer, relieving the employer from the obligations imposed upon it by law, to use ordinary diligence in furnishing safe appliances with which to work and safe conditions for the performance of the service, and that, so far as the rule had that effect, it was against public policy and void. The employer, continues the court, in *Holmes against the Southern Pacific Company*, is conclusively presumed to know how the service is habitually performed. Where the usual mode is departed from, the presumption would not prevail; and to make such a rule as the foregoing of any avail, even if not otherwise objectionable, the work must be so conducted that the employee may take the precautions prescribed, oth-

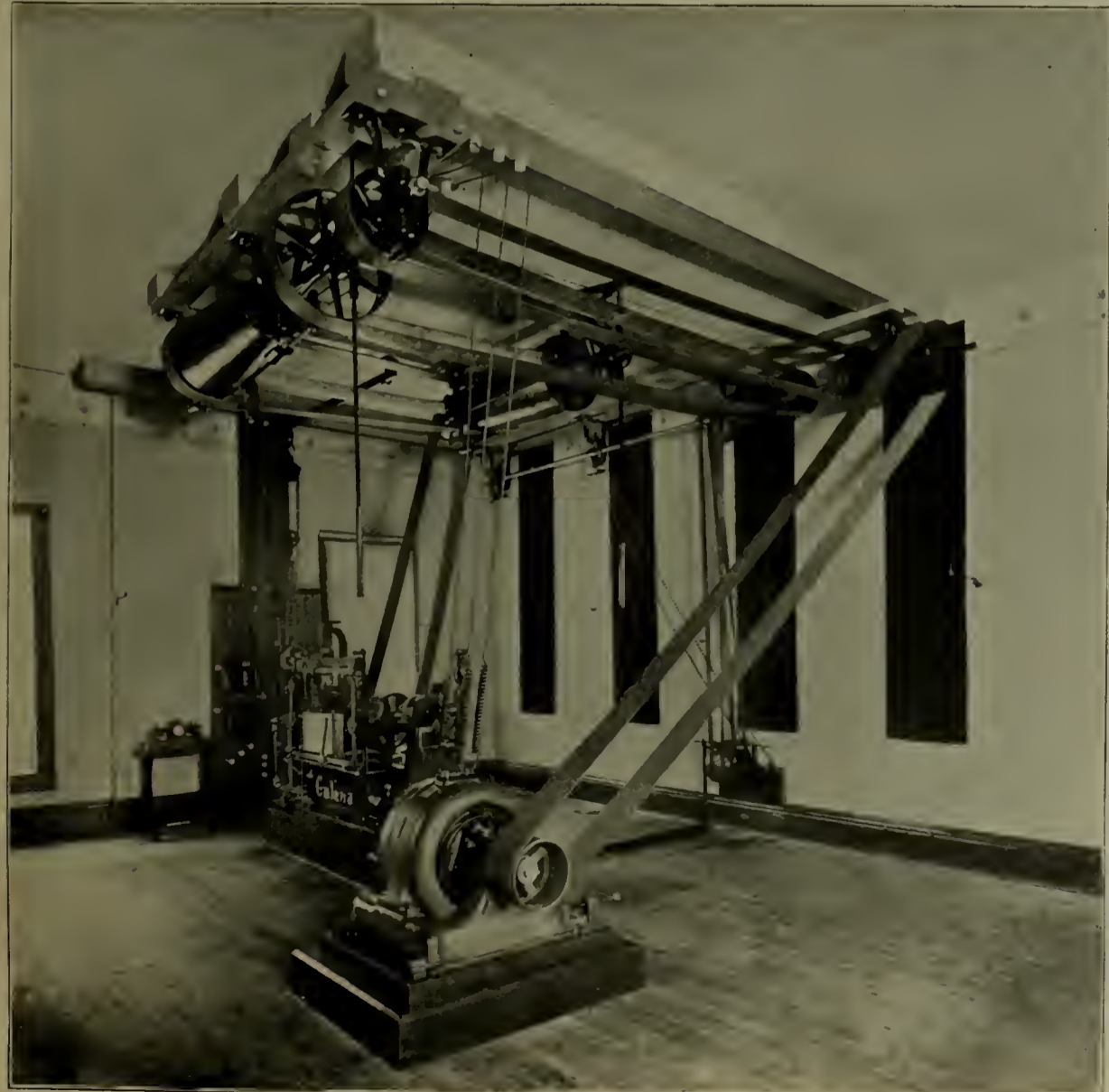

FIG. 8.—GALENA LABORATORY—PHYSICAL TEST ROOM.

erwise it is only a provision against the liability of the employer, and not a rule designed for the protection of the employe.

**CARBON IN PISTON RODS.**

At the Niagara Falls meeting of the American Society of Mechanical Engineers, Mr. Joseph E. Johnson, Jr., presented the following note on the carbon contents of piston-rods as affecting their endurance under fatigue:

The subject of the relative endurance under reversed stresses of materials of different tensile strength and hardness, has recently been attracting a considerable amount of attention from engineers, and the theory, until recently universally held, that for withstanding these repeated or reversed stresses a very soft material was necessary, has had to be revised to the extent of complete abandonment, at least in many cases. It is not with the idea of communicating anything new, but merely as a strictly practical confirmation of the valuable work done by others that the following data are given.

About six years ago the company, with which the writer is connected, bought a compound locomotive of the Baldwin or Vauclain type, no description of which is needed before this Society, except to recall, for the sake of clearness, the fact that the high and low pressure cylinders lie as close together as possible, one vertically above the other, the rods from the two cylinders being fastened to the same crosshead, which is of the four-bar type, and located centrally between the two rods. The wings or guiding surfaces are made very long in the direction of the stroke, to overcome the torque set up by the unequal and constantly-varying pressures on the high and low pressure pistons respectively. These pressures are made as nearly equal as possible by the steam-distribution, but practically there is always considerable difference at some part of the stroke, so that there is a stress tending to tilt the crosshead one way during one stroke, and the opposite way during the other. This stress, occurring while the crosshead is undergoing its regular reciprocating motion, puts a considerable pressure on the diagonally opposite corners of the guiding wings, and, the reciprocating motion going on while under this pressure, wear takes place on the corner of the wings first, and allows a slight rocking of the crosshead, a complete oscillation occurring at each revolution when running under steam.

The piston-rods are fastened to the crosshead with the regular taper fit drawn up to a shoulder by a nut. This connection being rigid, and the opposite end of the rods prevented from vibrating with the crosshead by the fit of the pistons in the cylinder, the rods are bent at the shoulder through a very small arc in each direction vertically, at each revolution.



FIG. 11.—GALENA LABORATORY—SLEEVES AND BRASSES.

This first locomotive ran for three years and two months, when a duplicate was bought, and the first put in the shop for a general overhauling previous to taking the place of the smaller engines on another part of the road, the new one taking the run of the old one. During the overhauling the piston-rods were renewed, having worn down too small to work well with the metallic packing any longer. The material for the new rods was ordinary "machinery steel," taken from stock on hand. The rods on this engine (No. 4), it should be stated, were straight from shoulder to shoulder, while those of the "duplicate" (No. 5) were reduced in the body, having a collar 1/4-in. larger than the rod and 1/2-in. wide next to the shoulder at the crosshead end.

After having been in service about 14 months, one of the low pressure rods of No. 5 "let go," and smashed the cylinder-head, without, however, doing any very serious damage. Within a few weeks the overhauled engine did the same thing.

This was becoming a serious matter, and after some careful consideration the writer ordered some genuine Swedish iron to make rods of. It was beautiful stock, and so soft that it acted almost like lead in the lathe, being very difficult to get a smooth finish on. A set of these were put into one of the engines at once, and ran about four months, when one of them let go in the same way. The rods that broke were all low-pressure ones, due undoubtedly to the fact that in the

"emergency," or starting gear, those cylinders get almost full boiler pressure—180 lbs. per sq. in. The rods were all broken in the same way, and right in the shoulder, the metal cracked at top and bottom, and the crack gradually widened, as could be seen by the worn appearance of the upper and lower segments of the break, which gradually approached each other until only a narrow horizontal strip of solid metal was left across the middle of the rod when the final rupture occurred.

Soon after ordering the Swedish iron, the writer came across one or two articles bearing upon this subject of the endurance of soft and hard steel or iron under fatigue, and describing tests made to elucidate this point, notably those of the Pope Tube Company and the Bethlehem Iron Company, which showed quite clearly that high-carbon steel was infinitely better than low-carbon, and that nickel-steel was better than either for such service; also that very soft material, like Swedish iron, lacked endurance under fatigue.

Therefore the breaking of the rod of this material was not a very great surprise, and was met by ordering material for a set of rods of high-carbon and one of nickel-steel from the Bethlehem Iron Company. These have now been in considerable use over a year, and we hope that they will last long enough to wear out without breaking.

The writer had the three rods which had broken, and the one which had worn out, analyzed, to see how they bore out the theory of high-carbon material versus low.

The results are given herewith:

	Sul-	M-ga-	Ph'or-	Sili-	Car-
	phur.	nese.	ous.	con.	bon.
First rod in No. 4 locomotive; machine steel; ran three years and two months without breaking . . . . .	.094	.70	.082	.014	.466
Second rod in No. 4 locomotive; machine steel from Longdale stock; ran fifteen months and broke . . . . .	.056	.64	.125	.021	.152
First rod in No. 5 locomotive; iron; ran fourteen months and broke . . . . .	.029	.12	.04	.148	.129
Third rod in No. 4 locomotive; Norway iron; ran four months and broke . . . . .	.006	.05	.055	.021	.044

It will be seen that these results bear out the theory to a striking extent, there being nothing in No. 1 to cause its far greater endurance except the carbon, and possibly to a slight extent the sulphur, which is also claimed by some to be a hardener.

It is very difficult to deduce any quantitative results as to number of reversals of stress producing flexure even approximately, because even given the approximate daily mileage of the engines and the size of the drivers, it is impossible to say what portion of the total running was done under steam, the grades being quite heavy, and the trains running by gravity for nearly half the total distance.

If 30 miles per day under steam, 28 days per month, be taken, the diameters of the drivers being 36 in., the revolutions per day would be, say 16,000, and per month, say 450,000; this would make for the second and third rods about 6,000,000 double flexures before rupture, and for the Swedish iron rod say 1,800,000.

There is no way of giving the amount of flexure; the crosshead probably never tilted more than 3-64 in. in 24 in. to either side of the vertical, but this amount varied as the wear occurred, and was taken up; also

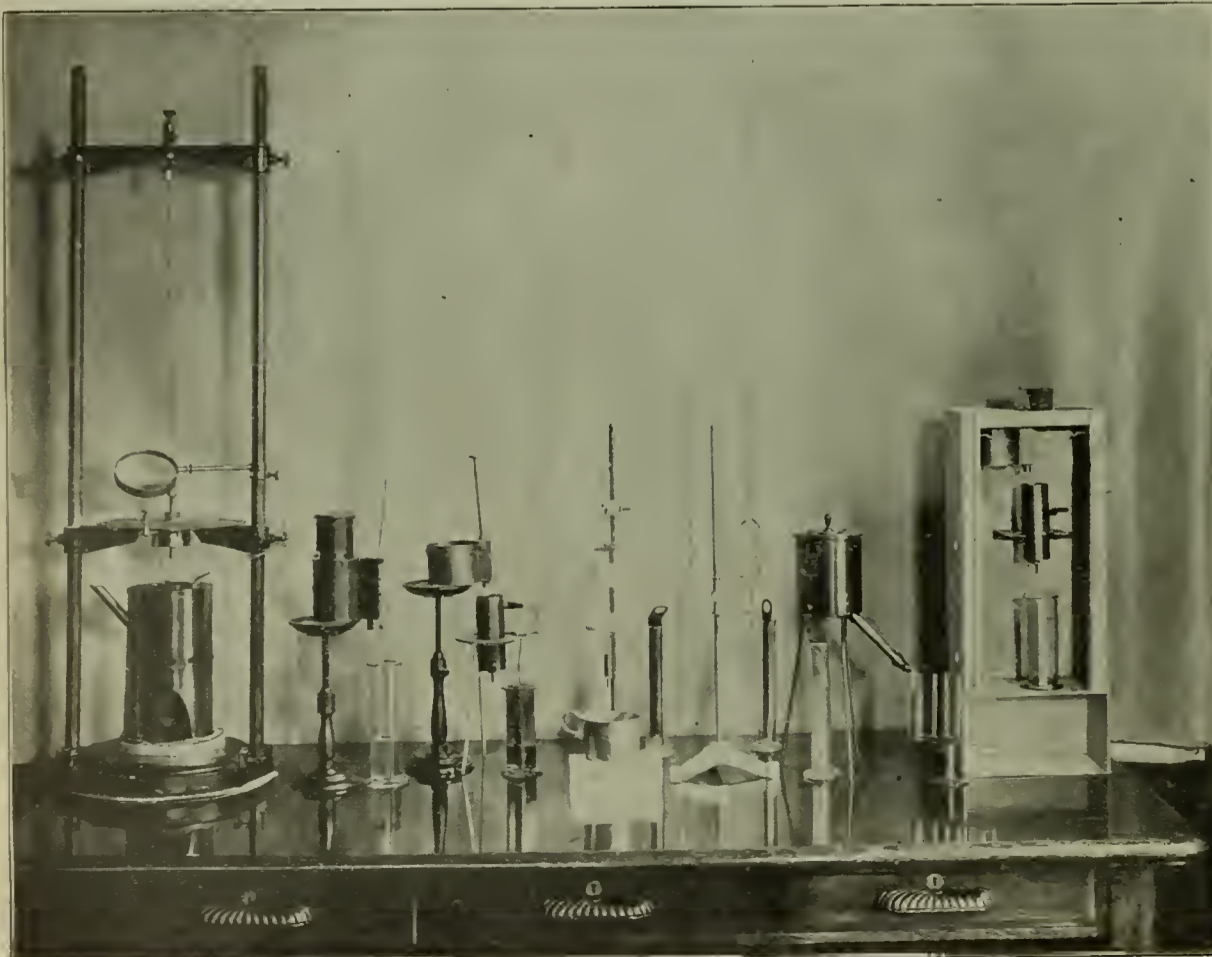

FIG. 12.—GALENA LABORATORY—VISCOSIMETERS.

it is not possible to tell what portion of the total length of the rod absorbed this flexure, so that it is impossible to give any figures having a scientific value.

The theory of the superior endurance of harder materials under fatigue has been explained many times, and by those far more competent to do it than the writer, so that nothing on that subject is said here.

As stated in the beginning, this is only intended as a strictly practical confirmation of facts already brought out by the splendid researches of others.

**A NEW SASH RACK—L. S. & M. S. RAILWAY.**

A new sash rack possessing many points of excellence has recently been built at the Englewood (Ill.) shops of the Lake Shore & Michigan Southern. It was designed by Mr. Thomas Fildes division master car builder of that road. Among the principal features of this rack are the galvanized angle iron sash supports, the split nut and screw for adjusting the movable partitions and the sprocket wheels with continuous chain at the end of the rack for operating the four screws simultaneously. These are entirely new and original features.

Only a few of the principal dimensions are given in our illustration. The rack being 44½ in. deep will easily allow one main window sash and the Gothic sash in the same compartments. This rack will easily hold all the sashes from four coaches. There are four 1¼ in. screws running the entire length of the rack, and each movable partition has four split nuts with eccentric arrangements as shown in detail. When the rack is to be adjusted the eccentric handle is placed in the position shown in the sketch of the rack, which forces the two parts of the nut together until it engages the screw. When in proper position the nut is separated, and as an additional precaution to prevent the screws being turned and

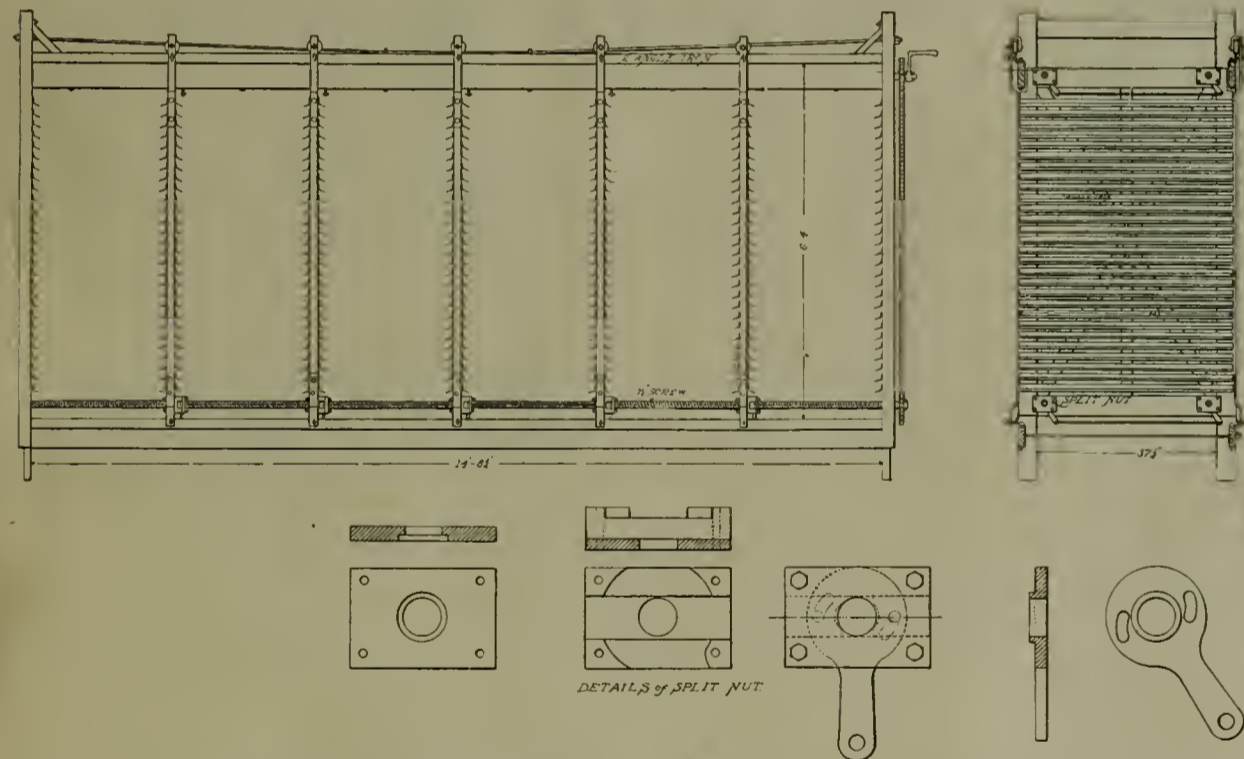

SASH RACK—L. S. & M. S. RY.

the partitions moved through oversight in not releasing the nuts, the four set screws shown are tightened. The partitions are supported by ½x1½ in. iron hangers with 3 in. sheaves running on 2 in. angle iron as shown. At the end of the rack are four ordinary sprocket wheels with chains connecting all four. One screw has an extension with operating crank attached.

The sketch shows the rack without a roof; the one at the Lake Shore shop being placed against the wall, having a roof sloping to one side to prevent anything being piled on top of it or the accumulation of dust or dirt. Of course any style can be used to suit the conditions or position in the shop. This rack is easily constructed, the angle irons being formed on the bulldozer. The iron supports allow a great many more sash in the same space than where heavy wooden supports are used, and they are moreover more easily kept clean.

The souvenir distributor most carefully doth try To give to railway men alone and do it on the sly; But the ladies and supply men have a nerve beyond his own, And they gather in his souvenirs and leave him sad and lone.

**THE NEW PIONEER LIMITED.**

Probably the most magnificent train that has ever been turned out of any car building establishment is that just completed by the Barney & Smith Car Company, Dayton, O., for the Chicago, Milwaukee & St. Paul Railway. In this train are compartment sleeping cars, straight or open sleeping cars, composite cars and day coaches, all built upon the most correct architectural lines, the proportions so carefully considered as to afford the most lofty and spacious effect within the prescribed limits. This is then treated to a classic

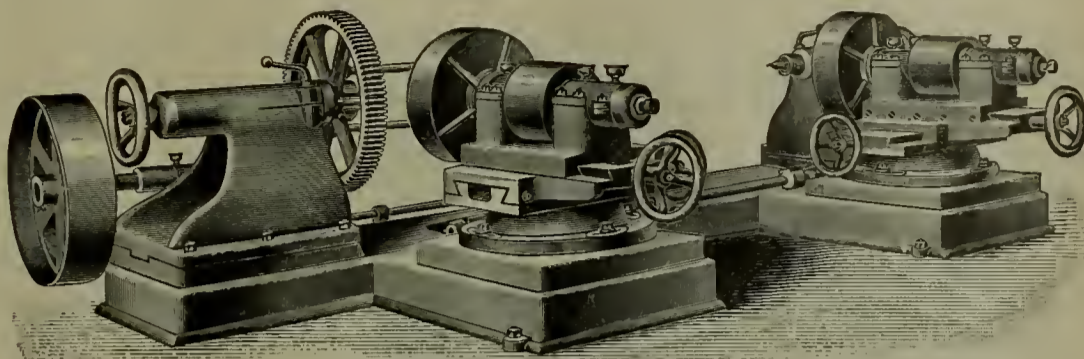

CHILLED CAR-WHEEL GRINDER.

decorative construction, in which the fundamental feature of the pedestal, column, entablature, pediment and arch is freely used.

The cars are all made to special and specific design, finished in rich Padouk, the finest St. Jago mahogany, and, rarest of all, the beautiful Circassian walnut. The regular sleepers are both finished in the Padouk, especially selected for color and grain, and the dark red color of the wood is effectively set off by the use of a deep soft blue in carpet, upholsteries, draperies

**CHILLED CAR-WHEEL GRINDER.**

The advantage of grinding chilled cast iron wheels has been satisfactorily demonstrated through several years of practice on some of the leading railroads of the country. Ground wheels, if made perfectly true, give smoother motion; moreover by reason of grinding the life of the wheels as well as the durability of the road bed is considerably increased. Another point is that a slid wheel can be ground true and its usefulness restored at a very

insignificant cost. Instances are on record where wheels which have been condemned for flat spots, after having made only a few thousand miles, have been ground, thereby bringing the total mileage above the average mileage of rough wheels; and also where some wheels have been ground a second time, and have made three different mileages, which otherwise would have required three rough wheels to perform an equivalent service.

Out of every one hundred cast chilled iron wheels made, there is hardly a single wheel that can be called strictly round, and if these wheels were ground before put in use the increase of their mileage would pay more than five times the cost of grinding. In order to successfully grind chilled wheels it is essential to use a machine that is strongly built in all its parts, so that vibration is reduced to the minimum. This is what is claimed for the grinder made by the Springfield Manufacturing Company, of Bridgeport, Conn. This machine, of which we give an illustration, will grind from ten to twelve pair of wheels, slid flat, and from forty to sixty pair of new wheels, per day, reducing the cost of grinding to the minimum. The construction of the machine is simplicity itself. It is arranged with head and tail stock and two grinding heads. The grinding heads are equipped with the Springfield patent chuck which is so constructed as to overcome the centrifugal force and thereby allow the work to be forced without danger of flying wheels. These chucks are mounted on a compound rest and any angle may be obtained. The machine is also constructed with a single grinding head, which is very practical for roads having a small number of cars in use.

**SAND DRIERS.**

Clark's "Perfect" sand drier (patented) illustrated herewith, made by the Parkhurst and Wilkinson



Company of Chicago. is now in quite general use among the railroads of this country, and many of these driers have gone to Canada, Europe, and South Africa.

The body of the drier is of heavy grey casting, consisting of several sections fitting securely one above another. The hopper which receives the sand to be dried is of heavy sheet steel firmly riveted at joinings. It rests upon the perforated ring through which the sand, when dry, falls.

Two sizes are made, No. 1 (drying about 10 tons per day) and No. 2 (drying about 5 tons per day, according to conditions).

and ceiling. The compartment cars, exhibiting in every detail the most elaborate care, are finished in three different woods, three rooms in Padouk, three in St. Jago mahogany and three in Circassian walnut, with the side passage of Padouk. The buffet cars are models of luxury and comfort, are finished in St. Jago mahogany and furnished in soft, rich green and supplied with sumptuous chairs, tables for writing, for periodicals, newspapers, etc.

It is, however, in the exquisite hand carving and marvelously beautiful marquetry work that this train excels anything that has ever heretofore been done in the way of car decoration. To the beauty and dignity of pure architectural style, has been added a lavish display of this remarkable work. In the composite car, for instance, a panel of choicest mahogany over the reading table has a design comprising the daintiest of the Empire designs, the wreath, garlands, vases, torches and bow knots, and exhibiting masterly skill in the shading and colors of the almost infinitesimal pieces of wood used, these being saffron, tulip, amaranth, cocoabola, boxwood, satinwood and English oak and prima vera.

The building of such a train is a really stupendous work, and the Barney & Smith Car Company have not spared time or effort to make their work what the railway company desired—a train to eclipse anything of the kind ever built.

Duplicate parts for repair can be had without delay.

This drier received the premium for "Best Sand Drier" at the National Exposition of Railway Appliances.

### THE BUCKEYE PORTABLE LIGHT.

The Buckeye portable light, which is shown in operation in our engraving, is entirely self-contained. Kerosene oil is used in this light, the oil being forced by compressed air to a burner which is heat-



THE BUCKEYE PORTABLE LIGHT.

ed by a simple process requiring only a few minutes. When the oil is turned on it is at once vaporized, and a strong, white, smokeless flame issues, the flame being from 12 to 30 inches long, according to the size of lamp. The air is forced into the tank by a strong pump securely attached to the tank. The tank capacity for oil is an all-night run without refilling, and the pump needs action only at intervals of four or five hours. When the light is started it almost runs itself; at all events it needs no expert to run it.

This light has the advantage that it can be moved from place to place where light is most needed. The flame can also be thrown to any angle desired, which is a valuable feature at times. The light is found to be a great help in railway wrecking, track-laying, repairing bridges, etc. And, moreover, the burner can be utilized for heating operations, such as shrinking on crank pins and locomotive tires, straightening rails, etc. For conductor's work at night it is almost indispensable. It excels the electric light in this particular, that it does not cast strong shadows, and it is nevertheless strong enough to penetrate fog and smoke.

The Buckeye light No. 2 is equal to 1000 candle power, and No. 3 to about 2000 candle power. The cost of maintenance is small, No. 2 using three-quarters of a gallon of oil per hour and No. 3 one gallon per hour. Macleod & Clark, who are the sole makers of this light, state that their model for 1898-9 is a great improvement over the previous light. The firm's address is 457 to 463 E. Front street, Cincinnati, O.

### STANDARD ENGINE TESTS.

At the Niagara Falls meeting of the American Society of Mechanical Engineers Mr. Geo. H. Barrus presented a "Plea for a standard method of conducting engine tests." Mr. Barrus reviewed at

some length the excellent work done by the society in devising standard methods of testing boilers, testing locomotives and testing pumping engines, and argued that as there was thus far no standarding, further standardizing should be undertaken so which applies to the general subject of engine testing that the whole subject may be covered. He therefore urged that the society should appoint a committee to devise a standard method of making engine tests in general, the work to comprise a harmonizing and revision of the work of the previous committees on locomotive tests and duty trials. Mr. Barrus then presented the following suggestions as to a general standard system:

The principal data required for an efficiency test of a steam-engine, are the weight of steam consumed and the amount of power developed. These two elements of data are fundamental whatever the type of engine, and whatever the class of work performed. It is evident at the outset, that a system of engine testing applicable to all engines would be a method of determining these quantities. Consequently, the proposed standard would relate primarily to these two things and to the expressions of efficiency derived therefrom.

If, for the moment, we pass by the steps required to obtain the necessary data, and take up the problem of bringing into uniformity the methods of reporting the results obtained from different classes of engines, the subject arranges itself in a simple manner. The desired uniformity will be secured if the tabular summary of results is expressed in two sections; the first section dealing with such data as apply to the working of the steam in the cylinders, apart from the peculiarities of the service which the engine performs, and the second section giving the data and results pertaining to the special individual work.

Following out this scheme more in detail, the first section of the tabular report would contain all the data of measurements of feed water, of steam used by the jackets and re-heaters, if these were employed, the quality of the steam, the weight of steam used by the auxiliary apparatus, and all the data of the various pressures, temperatures and speed relating to the work of the engine, including the pressures and other data obtained from the indicator cards. It would give the horse-powers developed, the weight of steam consumed by the engine and by the auxiliaries in a unit of time per unit of power, the deductions from an analysis of the indicator diagrams, and the total number of heat units consumed in a unit of time per unit of power. It would also present the standard decided upon for the expression of efficiency.

The second section of the tabular report would vary with each class of engine. In this section, there might be five sub-divisions, one applying to each main class of engines.

The classes which suggest themselves to me are as follows:

1. Factory engines, or engines employed in the production of power in general.
2. Pumping engines.
3. Locomotives, (a) shop tests, (b) road tests.
4. Engines employed in generating electricity.
5. Marine engines.

In the first sub-division of the second section, that relating to engines for general work, few additional data need be given, beyond those found in the first section. Engines in general are employed in generating power for such a variety of mechanical operations, that the simple expression of efficiency, based on the quantity of heat or steam used per gross or net horse-power per unit of time, covers essentially the whole ground. This section might, however, present the data and results of a coal test of the engine, where this was made; in which case, it would give the weight of coal burned, and all the various results depending upon it.

The second sub-division of the second section, that relating to pumping engines, would present the special data in regard to the work of the water end of the

engine, such as the quantity of water pumped, the number of feet lifted, and all the special data which are given in the report of the duty trial committee in vol. xii. of the Transactions. In this section would appear the results expressed in terms of "duty"; including the standard based on one million heat units.

In the third sub-division of the second section, viz., that relating to locomotives, there would be two parts, one pertaining to shop tests and the other to road tests; and in both of these, there would be the special data pertaining to the work of the locomotive, as formulated by the report of the committee on locomotive tests in vol. xiv. of the Transactions, including the standard of efficiency therein determined, viz., the quantity of so-called "standard coal" used per dynamometer horse-power per hour.

In the fourth sub-division of the second section, that relating to engines for driving electric generators, data would be given embracing the quantity and intensity of the current generated, the electrical horse-power developed, and the efficiency of the generator. In the case of railway engines, this would also include the current delivered to the motors on the line, and expressions of efficiency based on car mileage.

The fifth sub-division of the second part, that relating to marine engines, would present such data as pertain specially to marine work, such as the quantity of coal consumed and the results bearing upon it, the speed of the vessel, the slip of the screw, and the tonnage moved a given distance per unit of power.

The above is an outline giving the main features of one method of formulating the tabular reports so as to secure the objects in view.

Returning now to the methods of obtaining the data, one of the most important elements of data required is the quantity of work which the steam performs. The work done by the steam in an engine cylinder has in the past been ascertained, and probably will continue to be ascertained, by the use of the steam engine indicator. The reliability of this instrument is the foundation upon which a correct determination of the engine's efficiency rests. How the indicator should be applied, how it should be operated, how its springs should be calibrated and how the diagrams which it produces should be read and investigated, are questions which should be settled by the proposed standard method of engine testing; and to these questions little attention has been given and little required at the hands of previous committees. It may not be out of place to recall the fact that there is no accepted method amongst engineers of calibrating indicator springs; and it seems to me that in the work suggested, investigation and recommendation should be made as to the best mode of dealing with this important subject.

If the suggested arrangement of the tabular reports be followed, they would be preceded by a similar arrangement of the methods laid down for determining the various data. In the first place, directions would be given for ascertaining the data of the first section, or that applying to all engines, whatever their type; and these would cover the ground with that completeness which characterizes previous reports. Much of the material applicable to engines in general, given in the reports of the duty trial and locomotive test committees would appear in this section, and would there be dealt with once for all. The second section would similarly be divided into the sub-divisions named, and in each of the various sub-divisions complete directions would be given for obtaining the special data applying to the individual case. In the matter of duty trials and locomotive tests, the sub-divisions would deal with all the directions laid down in the previous reports.

I have thus indicated, in a very general way, what may be done to standardize engine tests covering all classes of machines, not with a desire to anticipate the action of a committee, should the Society see fit to appoint one, but rather to bring the subject to attention and "set the ball rolling."

### A NEW COMPOSITION BRAKE SHOE.

The Allen-Morrison brake shoe, which has been attracting the attentive interest of railway men, by reason of its performance on the South Side Elevated Railway in Chicago, belongs to the class of composition shoes—a class that has been shown by the tests made by the Master Car Builders' Association to possess rare qualities. The composition shoe gives, in laboratory tests, a higher coefficient of friction than a soft cast iron shoe, a remarkably uniform pull, and smooth stops, entirely free from jar, chatter or screech. The Allen-Morrison shoe has not as yet, we believe, been tested in the laboratory by the M. C. B. Association, but its long continued service tests on the South Side L. have developed the fact that it possesses just those qualities that the above quoted laboratory tests have shown to characterize a composition shoe. This new

shoe consists of a shell into which is forced, under heavy pressure, a composition the ingredients of which are entirely mineral. The vehicle used for combining these ingredients, aided by the form of the interior of the shell—which carries an internal dove-tail—affords a complete preventive against disintegration. Thus troubles had with previous composition shoes in the way of breaking up and dropping from the shell are effectively overcome. The Allen-Morrison shoe has, moreover, shown itself capable of long life in the way of wear, as well as of resistance to disintegrating influences. Its life in service has far exceeded that of chilled cast iron shoes. It performs its work equally well on either steel tired or chilled iron wheels; and it betrays no tendency to cut or roughen either class of wheel; indeed particles from its composition fill up small irregularities in the tire and give the latter a high polish. The wear of tire appears to be in amount about one-half that caused by chilled iron shoes. The service to which this shoe has been subjected on the South Side L is very exacting. There are be-

## AIR RESISTANCE TO THE MOTION OF TRAINS.

At a recent meeting of the Western Railway Club Prof. Goss, of Purdue University, presented an elaborate paper detailing the methods of research employed by him to determine the resistance of air to train motion. He employed an ingenious apparatus which we hope to describe later. His conclusions are in substance as follows:

A Summary of Conclusions to be drawn from the work with models may be stated as follows: When a model having the proportions of a standard freight car, or when a train of such models is submerged in currents of air, the length of the model or train being extended in the direction of the current, effects are observed which, briefly stated, are as follows:

1. The force with which the current will act upon each element of the train, or upon the train as a whole, increases as the square of velocity.
2. The effect upon a single model, standing alone, measured in terms of pressure per unit area of cross-section is approximately .5 the pressure per unit area as disclosed by the indications of the Pitot gage.
3. The effect upon the different models composing a

TABLE V—  
RESISTANCE OFFERED BY STILL AIR TO THE PROGRESS OF A LOCOMOTIVE AND TENDER.

Speed in Miles per Hour	Locomotive and Tender Running Alone		Locomotive and Tender Running at the Head of a Train	
	Tractive Force	Horse Power	Tractive Force	Horse Power
10	13	0.35	11	0.29
20	52	2.8	44	2.3
30	117	9.4	99	7.9
40	203	22	176	19
50	325	43	275	37
60	468	75	396	63
70	637	119	539	101
80	822	178	704	150
90	1050	253	891	214
100	1300	347	1100	293

train varies with different positions in the train; it is most pronounced upon the first model; next in order of magnitude is its effect upon the last model; next, its effect upon each intermediate model other than the second; and, last of all, is its effect upon the second model.

4. The relative effect upon different portions of a train is approximately the same for all velocities; for example, any intermediate model other than the second always has a force to resist which is, approximately, one-tenth that resisted by the first model, while the last model has a force to resist which is one-quarter that resisted by the first.

Conclusions.—The experiments already described and the results deduced therefrom, justify certain conclusions. These, while stated in definite form, are in fact subject to a variety of conditions affecting their value, the significance of which is fully discussed in paragraph 17. It will be well to note in this connection that the conclusions here given apply to trains and parts of trains having an area of cross-section equal to that which is common in American practice; also that being intended for general use they should not be expected to apply strictly in any individual case. Their application may, in individual cases, lead to errors of from 15 to 20 per cent., but even with this limitation the conclusions given are vastly superior to any that have hitherto been offered; and with this limitation also, they will doubtless be found entirely sufficient for every requirement arising in practice. The conclusions are as follows:

1. The resistance offered by still air to the progress of a locomotive and tender running at the head of a train, is approximately ten times greater than that which acts upon an intermediate car of the same train.
2. The resistance offered by still air to the progress of the last car of a train, is approximately two and a half times greater than that which acts upon an intermediate car of the same train.
3. The resistance offered by still air to the progress of trains and parts of trains may be expressed in the form of equations in which A is the tractive force in pounds necessary to overcome the resistance of the atmosphere, and V is the velocity in miles per hour. Such equations in which the values of constants are given to two significant figures are as follows:
  - a. For a locomotive and tender running alone:  
 $A = .13V^2$
  - b. For a locomotive and tender running at the head of a train:  
 $A = .11V^2$
  - c. For the last car of a train of freight cars:  
 $A = .026V^2$
  - d. For the last car of a train of passenger cars:  
 $A = .036V^2$
  - e. For each intermediate freight car in a train of 33-foot cars:  
 $A = .01V^2$
  - f. For each intermediate passenger car in a train of 66-foot cars:  
 $A = .02V^2$
  - g. For a train consisting of locomotive, tender and freight cars:  
 $A = (.13 + .01C)V^2$

where C is the number of cars in the train.

TABLE VI—  
RESISTANCE OFFERED BY STILL AIR TO THE PROGRESS OF A TRAIN CONSISTING OF A LOCOMOTIVE, TENDER AND CARS.

Speed in Miles per Hour	LENGTH OF TRAIN, INCLUDING LOCOMOTIVE AND TENDER.																	
	100 FEET		200 FEET		300 FEET		400 FEET		600 FEET		800 FEET		1,000 FEET		1,500 FEET		2,000 FEET	
	Tractive Force	Horse Power	Tractive Force	Horse Power	Tractive Force	Horse Power	Tractive Force	Horse Power	Tractive Force	Horse Power	Tractive Force	Horse Power	Tractive Force	Horse Power	Tractive Force	Horse Power	Tractive Force	Horse Power
10	13	0.36	16	0.44	19	0.52	22	0.60	28	0.76	34	0.92	40	1.1	55	1.5	70	1.9
20	54	2.8	66	3.5	78	4.1	90	4.8	114	6.0	138	7.3	162	8.6	222	12	282	15
30	121	9.7	148	12	175	14	202	16	256	21	310	25	364	29	499	40	634	51
40	213	23	263	28	311	33	359	38	453	49	551	59	647	69	887	95	1130	120
50	335	43	410	53	485	66	560	76	710	93	860	113	1010	133	1390	185	1760	235
60	483	77	591	85	689	112	807	129	1029	164	1240	198	1460	238	2000	314	2540	360
70	657	123	804	150	951	177	1100	205	1390	260	1690	314	1980	368	2720	507	3450	616
80	858	183	1050	224	1240	265	1430	306	1820	388	2200	470	2590	562	3550	738	4510	861
90	1090	261	1330	310	1570	377	1820	436	2390	552	2700	669	3270	786	4430	1000	5760	1370
100	1340	358	1640	438	1940	518	2210	594	2840	758	3440	918	4040	1080	5540	1480	7040	1800

5. The ratio of the effect upon each of the several models composing a train, measured in pressure per unit area of cross-section, compared with the pressure per unit area disclosed by the indications of the Pitot gage, is, approximately, for the first model of the train, 0.4; for the last model of the train, 0.1; for any intermediate model between the second and last, 0.04; and for the second model, 0.032.

Atmospheric Resistance to Actual Trains.—Thus far attention has been directed to the effects produced by currents of air acting upon fixed models similar to freight cars in outline and proportions, but much less in size. In what measure the results thus obtained will apply to trains of actual cars moving through still air, is a matter yet to be considered. It is fair to presume that had the models been larger than those which were really employed, the results observed would have been entirely consistent with those already given. If their dimensions had equalled those of a full-sized car even, there is no reason for supposing that the results obtained would have been disproportional to those which were actually observed from the smaller model, and it may be assumed, therefore, that the effects which would manifest themselves on a full-sized car of the same proportions with the model, may be predicted with approximate accuracy from the known effects produced upon the model.

A careful review of the subject will show that differences in form or proportions existing between the model and the actual cars may not be greater than those existing between two different types of actual cars. The differences in effect arising from these differences in form and proportion, therefore, may be no greater in the former case than in the latter. If this is true the models will serve as a good basis from which to make comparisons, and the belief is that the results which are given in succeeding paragraphs are not only sufficiently accurate for every practical purpose, but that they are as nearly true as any general statement applying to all conditions of service can be.

h. For a train consisting of locomotive, tender and passenger cars,  
 $A = (.13 + .02C)V^2$

where C is the number of cars in the train.

i. For a train of freight cars following a locomotive, but not including either locomotive or tender,  
 $A = (.016 + .01C)V^2$

where C is the number of cars in the train.

j. For a train of passenger cars following a locomotive, but not including either locomotive or tender,  
 $A = (.016 + .02C)V^2$

where C is the number of cars in the train.

k. For a locomotive and any train, either freight or passenger,  
 $A = .0003 (L + 347)V^2$

where L is the length of the train in feet.

1. For a train of cars, either passenger or freight, following a locomotive, but not including either locomotive or tender,  
 $A = .0003 (l + 53)V^2$

where l is the combined length of the cars composing the train.

4. A partial summary of results in convenient form is presented as Tables V., VI.

At Saratoga springy springs  
Full numerously abound;  
But under many a railroad car  
Less springy springs are found.

## PERSONAL.

Mr. J. C. McCullough has been appointed assistant traveling engineer of the Panhandle.

Mr. George G. Bywater, formerly master mechanic of the Utah Central, died May 16, aged 69.

Mr. James J. Traver, formerly master car builder of the Adirondack railroad, died May 20, aged 82.

## A NEW COMPOSITION BRAKE SHOE.

tween two and three stops made for each mile run and these stops are made from speeds averaging 30 miles per hour and running up to a maximum of 35 miles per hour. There are, moreover, many slow downs also required, for curves, etc. The shoe has stood up to its work under these severe conditions most admirably.

The general form, appearance and structure of the shoe are quite clearly indicated in our engraving in the top view. The lower view, showing a worn shoe, is an exact representation of a shoe that has a recorded mileage on the South Side "L" of 26,000 miles. The middle shoe—a flange shoe for street cars—is doing admirable work in that service, giving a duty of four months.

The shoe is the invention of Mr. A. J. Allen, foreman of car repairs, and Mr. J. F. Morrison, superintendent of the South Side Elevated Railway of Chicago, and is now controlled by the Allen & Morrison Brake Shoe Company, Fisher Building, Chicago. It is now being tested in the Chicago & Northwestern, the Fitchburg, Atchison, Topeka & Santa Fe, Baltimore & Ohio, and the Boston & Maine, on the Wagner sleepers, and on street railways in Chicago, New York, Kansas City, Paris, London, and Belfast.

Accept our little souvenirs,  
Nor fail to take them home;  
They show our thanks for orders past,  
And hopes for more to come.

—The Supply Man.

Mr. N. E. Jennison has been appointed assistant purchasing agent of the Chicago, Burlington & Quincy.

Mr. John W. Record has been appointed general foreman of the shops of the Santa Fe Pacific at Needles, Cal.

Benjamin Briscoe, formerly for many years master mechanic of the old Detroit & Milwaukee, died May 2, aged 86.

Mr. Thomas B. Twombly, formerly master mechanic of the Chicago, Rock Island & Pacific, has been adjudged insane.

Mr. J. W. Stokes has been appointed master mechanic of the Detroit & Lima Northern, with headquarters at Tecumseh, Mich.

Mr. John F. Shaughnessey has been appointed purchasing agent of the Minneapolis, St. Paul & Sault Ste. Marie, vice Mr. T. A. Switz, resigned.

Mr. Frank Slater has been appointed master mechanic of the Chicago & Northwestern at Escanaba, Mich., vice Mr. John W. Clark, resigned.

Mr. W. P. P. St. Clair has been appointed general storekeeper of the Wheeling & Lake Erie, vice Mr. C. C. Harter, resigned to enter other business.

Mr. Perry Webb has been appointed master mechanic of the Panama Railroad, to succeed Mr. D. G. Mott, who was drowned while out yachting.

Mr. Jas. T. Carey has been appointed road foreman of engines of the Pocahontas division of the Norfolk & Western Railway, vice Joseph Longstreth, resigned.

Mr. G. R. Jonghins, superintendent of motive power of the Norfolk & Southern, has been appointed mechanical superintendent of the Canadian government railways.

Mr. E. H. Harding has been appointed master mechanic of the Chattanooga Southern, with headquarters at Chattanooga, Tenn., vice Mr. J. H. McGill, resigned.

Mr. W. J. Hemphill, formerly superintendent of motive power of the Chicago, Peoria & St. Louis, has been appointed master mechanic of the St. Louis, Peoria & Northern, with headquarters at Springfield, Ill.

Mr. J. Medway, superintendent of motive power of the Fitchburg, has resigned. The motive power and car departments have been consolidated, with Mr. J. W. Marden, hitherto superintendent car department, in charge.

Mr. C. S. Stark, foreman of the car department of the Cleveland, Lorain & Wheeling, with headquarters at Bridgeport, O., has resigned to accept a position as chief joint-car inspector for all roads running into Pittsburg.

Mr. Carey Turner, who has been employed in the car department at the Central Branch shops at Atchison for a number of years, has taken a position as assistant master car builder on the Fremont, Elkhorn & Missouri Valley, with headquarters in Omaha.

Mr. T. F. Underwood, general foreman of the shops of the Atchison, Topeka & Santa Fe at Emporia, Kan., has been appointed master mechanic of the Santa Fe Pacific at Winslow, Ariz., and is succeeded as general foreman at Emporia by Amos Goodhue, foreman at Strong City, Kan., whose place is taken by John Murphy, formerly of the Newton shops.

### SUPPLY TRADE NOTES.

—The Chicago grain door has been specified on 1000 Illinois Central and 1000 Big Four cars.

—The Stillwell-Bierce & Smith-Vaile Co.'s Chicago address is now 311 Dearborn St., Chicago.

—C. H. Haesler & Co. are more than filled up with orders for their pneumatic drill and are contemplating a considerable enlargement of their shop room.

—The Memphis Car Works were sold, May 14, to C. J. Wagner, but it is stated that the price was so low that the sale may not be confirmed by the court.

—The Link-Belt Machinery Company have established a branch office at 521 Seventeenth street, Denver, Colo., with A. E. Lindrooth engineer in charge.

—A combined punch and shearing machine has been shipped to Corca for the Seoul-Chemulpo railway by the Royersford Foundry & Machine Co., Royersford, Pa.

—The Standard Railway Equipment Company has been incorporated at East St. Louis; capital, \$50,000. Incorporators: P. H. Murphy, C. F. Rodenberg and W. A. Rodenberg.

—It is reported that the Western Maryland is to build new shops at Baltimore, including a machine shop, a

car repair shop and a round house. The cost, it is said, will be about \$30,000.

—Mr. E. S. Marshall has resigned his position as manager of the railway department of the Missouri Malleable Iron Company, to become general sales agent of the Missouri Car & Foundry Company.

—The Carborundum Company will build a plant on the Canadian side of Niagara Falls. Six lots have been purchased and a contract for power made with the Canadian Niagara Falls Transportation Company.

—The Q & C Company is, in order to meet the large demands made upon it by its constantly increasing trade, preparing to add additional facilities to its works at Chicago Heights, enlarging the plant with the addition of a wing.

—Among recent shipments made by the Hilles & Jones Company, Wilmington, Del., was a carload of punching and shearing rolls to Bennett & Crawford, Seattle, Wash. They have also sent to the coast several carloads of plates punched and ready for bending and riveting into pipe.

—The Wrought Iron Bridge Company, Canton, O., has recently shipped a through turn-table to the Urbana shops of the Peoria & Eastern, a part of the "Big Four" railway system, and is now building for the same shops an electric transfer table, 32 by 218 ft. The electric attachments are put in by the Wrought Iron Bridge Company.

—The Wheel Trueing Brake Shoe Company, of Detroit, has been organized with the following officers: President, Judson M. Griffin; vice-president, Geo. M. Winslow; secretary, George Bradbeer; treasurer, not yet named. The articles of association show a capitalization of \$60,000, all paid in. The object of the new company is the manufacture of a patent wheel trueing brake shoe.

—A third order for pneumatic tools has been received by the Chicago Pneumatic Tool Company from the Smorvo Locomotive Works, at Ninji Novgorod, Russia, with which Mr. Wm. F. Dixon is very prominently connected. The order embraces six pneumatic hammers and one piston air drill, Mr. J. W. Duntley, president of the company, has just returned from a very successful business trip to Europe.

—The Diamond Rubber Company of Akron, O., is now controlled and managed by Mr. Walter B. Hardy, who was connected with the Revere Rubber Company of Boston for 20 years. Associated with him is Mr. Wm. B. Miller, formerly assistant manager of the Revere Company and located at Buffalo, N. Y. Others actively connected with the interests of the company are Mr. J. K. Robinson, vice-president; Mr. A. H. Noah, treasurer, and Mr. C. H. Palmer.

—Among others the following orders for cars are reported to have been placed during May: Illinois Central, 500 coal cars of 80,000 lbs. capacity, half to Mt. Vernon Co. and half to Wells & French. Chicago, Rock Island and Pacific, 500 box cars to the Michigan-Peninsular Works. Chihuahua & Pacific, 50 box and 50 flat cars of 30 tons. Illinois Central 1,000 thirty ton box cars, to Haskell & Barker. Grand Trunk, 250 box and 250 stock cars, to the Michigan-Peninsular.

—The company known as the Heath Rail Joint Company will be reorganized in a short time. It will put on the market an entirely new rail joint, which will be a combination of the best features of the old joint with many improvements. The company will also manufacture tie plates and Dorwin's patent guard rail clamp, and, probably, rail spikes. The company's factory will be at Chicago Heights and its general offices in the Tacoma building, Chicago. The rail joint will be given a new name.

—The Q & C Company report a large order for McKee brake slack adjusters just received from New York for shipment to a prominent railway in Peru, showing that the merits of these goods are appreciated abroad as well as in the United States, where they are now in use on 32 different roads. The company have also just made shipment of one of their largest power sawing machines, No. XXXXX, to Sheffield, England. This machine carries a 36-in. blade and is used for cutting risers and gates off steel castings.

—The new shops of the Atchison, Topeka & Santa Fe at Cleburne, Tex., are now under way and are to be completed by December next. They embrace one machine shop (stone), 90x340 ft.; one boiler shop (stone), 340x90; one car shop (stone), 90x180; one paint shop; one engine and boiler house, 40x80; one coal house, 22x40; one storehouse, 40x200; one two-story stone office building, 44x66; one pattern house, 40x80; one fire department house, 25x40; one iron water tower, 16x100; one stone oil house, 30x60; one electrical room, 20x40; one brick stack, 100 ft. high; one covered platform, 40x100.

—The Hancock Inspirator Company announces that it has brought suit in the U. S. circuit court for the district of Massachusetts against the Penberthy Injector

Company of Detroit, Mich., for infringement of the Loftus patent, number 300,092, generally known as the "ring valve" patent. A suit against the manufacturers of the Welcome injector had previously been instituted. The Hancock Inspirator Company claims that the Loftus patent covers every form of automatic injector using a ring valve. It owns this patent and has licensed under it only the American Injector Company of Detroit, Mich.

—All who like to catch fish when they go a-fishing will be interested in the "luminous" bait advertised on another page. These phantom minnows, spoons, flies, etc., are coated with a substance which absorbs light when exposed to the sun or artificial light and thus become phosphorescent in the dark. For fishing in dark or roily water or in the night time these baits are said to be very effective. They have been in use for several seasons and the manufacturers, the Enterprise Manufacturing Company, Akron, O., have letters commending them from all parts of the country. There are many railroad men who are fond of fishing out have little time to devote to it. These new baits ought to enable them to get a good string in a short time. The company manufactures a full line of all kinds of artificial fish baits, both luminous and non-luminous.

—The following orders for locomotives are reported among others as placed during May: Baldwin Locomotive Works: 68 engines for the Eastern Railway of China; two switch and one road engine for Elgin, Joliet & Eastern; two 19 by 24 ten-wheelers for the New York & Ottawa; one 19 by 24 for the Atlantic Mining Co. The Brooks Locomotive works: two 14 by 24 passenger and two side tank freight engines for the Hankaku railway of Japan; eight engines for the Pecos Valley road; two 18 by 24 engines for the Duluth, Mississippi & Northern; Schenectady Locomotive Works: ten mastodon compound engines, 23 and 35 by 32 and seven eight-wheel 20 by 24 passenger engines for the Southern Pacific; fifteen 19 by 26 ten-wheel engines for the Chicago & Northwestern, 26 double end engines for the Nippon, and 12 consolidation freight engines for the Kiushiu railways of Japan. Pittsburg Locomotive Works: Two 17x24 six-wheel engines for the Lorain Steel Company.

—There can be no more convincing commentary upon the wide range of applications of compressed air power, says an exchange, than the sales report of a single manufacturer of this class of machinery for the months of February, March and April. In all, nineteen air compressors were sold by this company for operating pneumatic stone tools, chipping and calking tools, air hoists, etc.; nine air compressors for moving and elevating acid and chemical solutions; four air lift pumping plants were installed and placed in operation; three air compressors were furnished to rubber works for removing hose from mandrels, testing hose and inflating tires; one compressor was supplied for the pneumatic transmission of messages; two for oil burning plants; three for racking off beer in breweries; one for spraying brick in the process of manufacture, and six for unusual applications of compressed air power. In addition to this number of air compressors furnished for domestic use, four were exported to Europe for operating pneumatic shop plants. Among the orders of especial interest included in the above summary may be mentioned a plant installed at the navy yard, Brooklyn, New York, for supplying pneumatic drills, paint machines and hammers, and one furnished to the Yarrow ship yard, London, for operating pneumatic tools. Another installation of interest is a compressor at the Dnnn Building, New York, which supplies compressed air driving nozzles for cleaning the iron grill work of the elevator shafts.

—The following information concerning the recently organized American Brake Shoe Company is furnished by Mr. Wm. D. Sargent, its president: This company was organized for the purpose of maintaining a careful inspection of the product of all the licensees under the Diamond S. patents, for the purpose of insuring uniformity throughout the entire country, and of securing to the railroad companies using these shoes a continuance of the good results obtained from the Diamond S. shoes manufactured by the Sargent company. It is also intended to provide inspection of brake shoes in service for the purpose of giving the railroad companies the benefit of the services of experts in this branch of railroad equipment. Many inquiries as to the Diamond S. shoe from parts of the country remote from Chicago have been received by the Sargent company. The following licensees are now prepared to fill orders, and the American Brake Shoe Company is in a position to guarantee that their product will be of uniform excellence. The licensees are: The Sargent Company, offices: Old Colony building, Chicago, Ill.; Security building, St. Louis, Mo.; Endicott Arcade, St. Paul, Minn.; 537 Mission street, San Francisco, Cal. The Ramapo Iron Works, offices: Hillburn, N. Y., and Havemeyer building, New York City. Parker & Topping, offices: Endicott Arcade, St. Paul, Minn., and Albina Foundry, Portland, Ore. Central Brake Shoe Company, offices: Ellicott square, Buffalo, N. Y., and Havemeyer building, New York, N. Y.

# RAILWAY MASTER MECHANIC

WALTER D. CROSMAN, Editor  
EDWIN N. LEWIS, Manager.

PUBLISHED MONTHLY BY  
THE RAILWAY LIST COMPANY.

Devoted to the interests of railway motive power, car equipment, shops, machinery and supplies. Communications on any topics suitable to these columns are solicited.

Subscription price, \$1.00 a year, to foreign countries \$1.50, free of postage. Advertising rates given on application to the office, by mail or in person. Address

THE RAILWAY LIST COMPANY,  
The Rookery, Chicago, Ill.

The Official Railway List is Published by this Company.

VOL. XXI. CHICAGO, JULY, 1898. No. 7.

THE Arbitration Committee acted upon a truly happy thought when it invited the members of the M. C. B. Association, attending at Saratoga, to participate in its afternoon meeting the day before the consideration, by the convention, of the interchange rules. Many members availed themselves of this opportunity for a preliminary informal threshing over of the rules, and they shared, with the committee, the feeling that it was a good plan. The next day's work proved this.

AN entertaining and instructive address was given the Master Mechanics at Saratoga on Tuesday evening by Prof. W. F. M. Goss of Purdue University. The professor gave in a most attractive manner a carefully prepared lecture on the "Training of the Engineer," illustrating his text with a large number of stereopticon views. No man listened to that notable lecture without wishing that he might be young again to pass through the schooling that was so attractively portrayed, and no one there that was blessed with a boy but wished that that boy could have such training.

EVERYTHING depends on the right move being made at just the right time, and everyone who attended the meeting of the M. C. B. association at which the price for repairs east and west of the 105th meridian was under consideration felt that this was the case when Mr. Rhodes suggested referring the subject to a committee that would prepare a report in time to have it submitted not only to the officers in charge of car departments but to higher officers for guiding instructions. The latter officials will know best whether or not the difference received for hauling in the two territories mentioned should be considered in fixing charges for repairs.

THE adoption of a "blanket" price of \$7.50 for couplers used in repairs will be accepted gratefully by a large constituency which has long wondered at the imposition of the frequently excessive "secretary's" prices.

It is evident that the consolidation of the two associations is near—probably not more than two years ahead. The tendency this way has been strong for years and lately it has grown in strength. Last year it almost took definite shape. This year President Leeds' outspoken address gave it a start from which there will be no receding. The committee's report on Mr. Leeds' suggestions pushed it a step farther; and the election of a very prominent master car builder to a vice-presidency of the Master Mechanics' Association—a gracious act, the spirit of which the Master Car Builders' Association should have forestalled by electing a motive power man to its presidency instead of holding to its traditions—will have a tendency to make assurance of consolidation doubly sure.

THE action taken by the car builders on the air brake question, while decidedly radical, was practically unanimous. It is a fact, we believe, that just such action is not only wise but very timely. It was voted to direct the standing committee on air brake tests to, at the earliest practicable moment, test all

triple valves in the market with a view of seeing if they meet all the requirements of the specifications of the association's "recommended practice." This committee was further ordered to report the results of these tests to the executive committee, which latter was directed to immediately thereafter publish the report and distribute it to the members. It was further decided that the report should give the names of the triples in its report. This was a move in the right direction and will meet with very general approval.

THE Daily Railway Age was the leading, in fact the only, ornithological exhibit at the convention. It was truly a bird, as its editor frequently asseverated. Its plumage was never before so gorgeous, and as for its "insides" there were judicious proportions of white and dark meats. But it was a little shy on the giblets—that is to say the "bright and snappy" paragraphing which has distinguished it in previous years was somewhat lacking. "The Daily" has become a recognized convention institution, one of distinct value not only to convention attendants but to the sitters at the press tables, and, take it all in all, its present series is far better than all its predecessors. The Daily Railway Age and the men who make it deserve great credit and hearty thanks. Any professional or business jealousy that the devil may have secretly inserted into our soul in past years has been eliminated and we offer sincere congratulations to the entire outfit.

THE master car builders found this year that their noon-hour talks took on a new value, by reason of the fact that so many of the topics were treated by written instead of oral discussion. This feature permits of more thorough and exact expression of the opinion or observation of the contributor to the discussion, and a consequent enhancement of the value of the literature turned out in annual proceedings. But while valuable in this way it rather tends, we fear, to kill the "short, snappy" characteristic of the noon-hour talks that has made them so popular in the past. It tends to do this in two ways, first, perhaps, by discouraging the would-be impromptu speaker who hesitates to follow the carefully written out note of his fellow member by an off-hand oral talk, and, second, by reason of the fact that the written note is apt to consume in delivery all or more than a fair share of the ten minutes which under the rule is allotted to each noon-hour topic.

SOME years ago (in December 1887) the RAILWAY MASTER MECHANIC published a cut of what was—so far as we can learn—the first air hoist operated in a railroad shop in this country. Indeed, it may have been the first pneumatic hoist operated in any shop on this continent. It was designed by Mr. Gordon, then master mechanic of the Philadelphia, Wilmington & Baltimore shops at Wilmington, Del., assisted by his foreman, Mr. Turner, who was and is his successor in office. The cut attracted wide attention and had much to do in awakening interest in the use of air in railroad shops. This simple air hoist was then considered quite a remarkable device, and everybody was interested in it. But in the exhibits of pneumatic tools the other day at Saratoga, out of eleven different pneumatic tools shown in one exhibit only one of them was a pneumatic hoist. The others have all been devised and brought out since the day when Messrs. Gordon and Turner suspended an air cylinder and piston over a side track, connected it with reservoir supplied by a Westinghouse air pump some 75 feet away, and found that, with this new device, they could unload ear wheels far more rapidly and economically than ever before. The grain of mustard seed has produced a great tree, the branches of which are still spreading and multiplying.

THERE has always been considerable rivalry between the east and west for the control of the supply men's organizations and committees at the June Conventions, but for some years the east had the long end of the lever—and used it. This year, however, the west seems to have won the leadership and (we dare not say for that reason) the business of entertainment was certainly managed in a business way. In some past conventions the unbusiness-like waste of the entertainment funds has been simply sickening. This year the assessments were 30

per cent less to start with than ever before, and we are assured that fully 30 per cent of the amount paid in will be returned. And yet, while the number of those for whose entertainment the money is paid in, was as large or larger than ever before, there was no lack of carriages or flowers or candies; the music was of the very best and all reasonable hunger for entertainment was fully satisfied. The supply men are learning that the extension of quiet and not too lavish hospitality is best calculated to please their guests. We offer to the members of the standing, assessment and other committees our hearty congratulations and we believe that the high standard they have fixed and the record they have made this year will be emulated by all the committees of the future.

## TONNAGE RATING FOR LOCOMOTIVES.

The two notable papers at the Master Mechanics' convention were those on Tonnage Rating and on the Efficiency of High Pressure Steam.

The discussion on the former subject indicated either a want of interest in it or a failure to comprehend it. The array of algebraic formulæ, and curves to illustrate figures graphically, which usually illuminate Mr. Henderson's papers, may have discouraged some from reading this one; but it will be found well worthy of careful perusal and most of it can be mastered by the aid of simple arithmetic.

It may be very pertinently asked:—if it is necessary to make a practical test in service to determine the tonnage rating of a locomotive, what is the use of making a theoretical determination?

It is found as a rule that locomotives haul more than theory will account for, unless note is taken of the advantage gained by the velocity head gained in descending a grade, as assisting in going up the next grade. In order to do this the exact speed at which the train approaches the up grade should be known; but unless trains are equipped with good speed recorders this element in the calculation will be taken at too low a figure. As was pointed out in the discussion, very few railroads have their profiles of track correct to date and changes in grade are often made, in improving the track by roadmasters, which do not appear on the old profiles. With such sources of error in the data to be used it is not surprising that theoretical ratings do not often agree with those obtained by a practical test.

We claim, however, that a full knowledge of the method of making a theoretical rating will be found very useful in showing how the tonnage of trains may be increased either by changes in track or by the use of larger engines or both.

The maximum rating is moreover considerably affected by the schedule—that is by the speed, and by the location of stops, for stations or for water—and this part is one which the superintendent should study carefully and which admits, on many roads, of vast improvement.

The virtual profile showing the equivalent grade which the train can ascend with a velocity head is one which the chief engineer can determine; and when engaged in such a problem he will soon find where it is possible to cut down a grade with a slight expense and thus materially reduce the cost of operation.

It is probable that tonnage rating is the principal cause of the rapid growth, in recent years, of the size and hauling capacity of locomotives. It has had the same effect on traffic management as piece-work in the shops has had on shop management.

The knowledge of "what things are costing" is always salutary, and the knowledge of how much an engine will haul, when measured exactly in tons, has led to the demand for larger engines to haul more tons on one train. It is now plainly seen that a freight engine cannot be too large, so far as economy of operating is concerned; and the only limits are those imposed by track considerations, the strength of couplings or the supply of freight for regular and heavy trains.

The master mechanic will now, as never before, be called on to provide more powerful freight locomotives, and this is not only the result of tonnage rating, but it is the important part which he should take in meeting the demand for increased tonnage of trains.

A complete solution of the problem of tonnage rating on any road is not, therefore, the work of one

officer, but, as we have tried to show, it involves questions connected with three departments—the superintendent's, the chief engineer's, and the master mechanic's. When these officers co-operate with the intention of reducing the cost of transportation to the lowest possible point, each one will find it possible to improve on present methods.

The track, the traffic, and the motive power departments are all concerned in tonnage rating, and the master mechanic should not assume that he can do all that can be done by simply rating engines to present conditions; but he should seek the assistance of other departments in making a general improvement in the methods of operating freight traffic.

#### SPECIAL METAL TRUCKS.

It is getting so that the term "metal trucks," which at first indicated in a short form the different designs of trucks which have been made to replace the arch bar truck for heavy capacity cars, no longer conveys just the meaning intended, and the discussion on prices, at the M. C. B. convention, emphasized the need of a word to express the proper meaning. Steel trucks, patented trucks, pedestal trucks and other terms were suggested, but some one had an objection to each, so in despair we have used the combination, "special metal trucks."

Those who were at the convention saw some new designs in model size, and larger, but these were not altogether new to those who follow the patent office reports and who have seen many other ideas for trucks pictured that possibly will grow into model and larger sizes in time for succeeding conventions. It has been said that only one design of special metal truck has passed to the stage which may be called developed, and, while it is not necessary to agree with such declaration, it is undoubtedly the fact that probably in no other similar device have there been so many designs discarded, after a more or less extended trial, in proportion to the number put out than has been the case with special metal trucks. Whether or not all but one such design of truck has failed it must be acknowledged that even this truck passed through a developing stage which was not entirely a bed of roses for those who were interested in its development; but it is quite strange that other designs should start with the same weaknesses and be discarded or continue to worry their owners, when it is so easy to note the development of the one which has reached the more satisfactory stage.

The development of the first special metal truck was slow; the development of others should be slow, yet faster than the first if advantage is taken of the experience of others; but the greatest care must be exercised not to force the development to such a point as to kill the design, by getting out so many trucks with, perhaps, an easily remedied weakness, as to make every one feel unkindly toward the design.

An important question, we may add, which should be settled by the M. C. B. Association as early as possible, is that concerning standard boxes, journals, etc., for large capacity cars and for trucks of special metal design.

#### RELATING TO THE PURCHASE OF SUPPLIES AND TO "TRIAL ORDERS."

The Port Arthur route, comprising the Kansas City, Pittsburgh & Gulf and allied lines, issues, through general manager Gillham, a very sensible circular relating to the purchase of supplies, and to "trial orders." We append this circular in full:

We have been called upon at various times to pay damages resulting from our having unlawfully used articles infringing patented devices, therefore the following instructions must be rigidly observed by all concerned.

Before any improvements are put into use on these lines, full detailed drawings of the same must be submitted to the purchasing agent, who will have a careful investigation made regarding all questions of infringement, and report result of inquiry to the undersigned, who will issue to the proper department additional instructions. This company is a member of the Western Railway Association, whose particular business it is to investigate matters of this kind.

The practice of various persons allowing manufacturers or dealers to ship articles for trial will also be discontinued from and after this date. If it is desired to make a trial of any article of supposed merit, regu-

lar requisition for such article for trial purposes will be made in the regular manner provided for and the arrangements for the trial will then be completed by the purchasing agent.

The latter paragraph especially commends itself. It is often the practice on railways, even upon lines supposedly well systematized, to accept various devices "for trial." But it is a weak and unsatisfactory policy to do so. The article so accepted is sent out on the road as a part of a locomotive or a car or as a piece of track equipment, or is sent into the shop, and as a usual thing that is the last of it, or at least the last that is good of it. No one has especial interest in it or in its performance, and perhaps its very existence is entirely lost sight of.

An incident illustrating this comes to memory as we write. The promoters of a certain brand of piston rod material, after long seeking to establish trade with a certain road, finally solicited permission to place a couple of rods in service "on trial," and eventually were granted their request in a moment of indulgent good nature. Months afterward, when the makers of the material asked how the rods were doing, the rods could not be located. A considerable correspondence disclosed the fact that they were indeed lost, and the further probable fact that they had been removed at some remote division shop when the engine was undergoing some overhauling. The whole so-called "test" was a farce, and could hardly have been otherwise. The superintendent of motive power of the road in question was at the time of placing the rods in service completely engrossed in car couplers, or air brakes or bearing metals or something of the sort—he had for the time being no especial interest in the piston rod material problem. Therefore that particular "trial order" was practically foredoomed from the start.

This sort of thing happens continually. Such placing of trial orders is apt to result in chagrin and disappointment to the maker of device or material; and it not infrequently results in annoyance to railway officials who see their road quoted in circulars as "using" this, that, or the other device when it is simply obliging a too persistent agent by permitting his article to go into service. No trial order should be given until the road is good and ready to make a real trial and to definitely study the class of devices or materials that the proffered sample belongs to.

#### THE RIGIDITY OF METAL TRUCKS.

The statement is sometimes made that the pedestal type of truck is three-legged, while the diamond type of truck is not, or, perhaps, the statement is more frequently put thus—that the pedestal type of truck is more three-legged than the diamond type.

The real facts in the case seem to be the exact reverse of this for the following reasons:

In the pedestal type of truck we have the flexibility of the springs at the four corners of the truck to make the necessary adjustment to the uneven track, whereas with the diamond type of truck there is nothing whatever to make this adjustment but the flexibility of the metallic frame itself, the springs under the bolster not being competent to assist in such adjustment.

If we consider a plane passing through the tops of the journal boxes rigidly attached to the frame of the diamond truck, and to compare therewith, we consider a plane passing through the face of the spring seats for the tops of the springs in the pedestal type of truck, the matter can, perhaps, be made clear.

Considering each of these four localities in each type of truck to be reduced to a point which is the center of each, these four points are presumably in the same plane in each truck, and if it is built properly, and is not too flexible to give long service, they will remain in one plane. When either truck passes over a rough track a plane can be passed through the points of contact of any three of the wheels on the rails, but the fourth point of contact will lie outside of this plane, and the adjustment in the truck so as to prevent too great divergence from parallelism of the fixed plane in the truck construction referred to, and the plane passing the nearest to all four of the points of contact of the wheels with the rails, and therefore also to prevent too great variation in the pressure of the four wheels upon the rail, is made through the springs in the pedestal type, whereas it is only made by the wrenching of the structure itself in the diamond truck; and the variation of pressure

of the wheels upon the rail in the latter will, consequently, be greater over a given piece of uneven track than it will with the pedestal type of truck.

In this connection it is perhaps well to state that the longer the springs and the greater their action the more even will be the adjustment of loads carried on the four wheels on an uneven track in the pedestal type of truck, whereas, as already stated, in the diamond type of truck the springs do not affect this adjustment, it being a matter wholly of the flexure of the truck frame itself.

The erroneous impression first referred to—the three-legged idea—may have arisen from the construction of the pedestal type of truck with too little clearance between the bottom of the box and the pedestal tie-bar. It is only by the box moving down in the pedestal jaws so that the box strikes the tie-bar, that the wheel could be lifted off the rail, or that the adjustment above referred to through the springs would be interfered with. It is important that the pedestal type of truck be constructed so that enough clearance will be left between the bottom of the box and the pedestal tie-bar when the car is empty, so that free action of the springs will not be interfered with by the box striking this tie-bar.

#### THE M. C. B. COUPLER.

Some less startling grouping of letters and words might have been used to direct attention to the following thoughts, but beneath it so much of criticism and so much of praise can be written that the pen runs almost as smoothly in the one direction as in the other. It is the desire now, however, to direct attention to the remarks made in one of the meetings of the M. C. B. Association concerning this coupler. The prevailing opinion seemed to be that couplers made of the best material obtainable were none too good for an attachment which must resist all pulling and buffing strains, and that a railroad should be very careful in selecting couplers for its own cars and in inspecting couplers on cars offered in interchange. It was urged that couplers should be purchased on specifications and inspected to insure that the requirements are fulfilled.

We are heartily in accord with all such suggestions and believe that couplers, axles, wheels and other important parts of cars should be thoroughly examined before being used and the undesirable ones discarded for railroad use; here is just where the rub comes and where the whole system of inspection comes to naught, in so far as it concerns material which goes on cars used in interchange. The A. B. & C. Railway inspects carefully all couplers, axles, and wheels, to insure that it gets the best; and now and then rejects a lot as being unfit for use. What becomes of the rejected material? Are the couplers and wheels remelted and mixed and poured again? Are the axles sent to the scrap pile? If the A. B. & C. Company is buying its material for new cars, it is quite possible that before its own new cars, made of the first class material, are running over its lines, other cars running on the wheels discarded by it, fitted with axles discarded by it and hauled by couplers discarded by it, will be running over its lines while its cars, made of first-class material, are doing duty at six mills per mile on a foreign road. The result is that the road which inspects its material as a safe guard against accidents on its own lines, has no protection against such accidents as may be caused by the use of undesirable material in cars of other lines.

The tendency has been to make owners responsible for maintaining their own cars and if inspection of couplers is urged it is just as important to inspect wheels and axles and other material entering into the construction of trucks, and on this basis the rules of interchange will not be satisfactory until each road is protected by itself and every other road from the use of bad material in what may be called "the vital parts" of cars. If a wheel is discarded by one road it hardly seems right that it should be possible for the same wheel to cause an expensive wreck on the road which rejected it for use on its own cars; nevertheless this is entirely possible now, not only with wheels but also with axles and couplers. "Owners responsible" will not cover these cases under the present rules, and when inspection is urged quite strongly it is but a step further to a common inspecting bureau, through which shall pass all material used in cars offered in interchange, to insure protection for those roads



which demand such protection, and but a step further to a condition in which the general design of car and detail arrangement of the "vital" parts of all cars offered in interchange must meet the approval of a committee of as high personal standing as the arbitration committee.

### THE MASTER CAR BUILDERS' ASSOCIATION.

#### Proceedings of the Thirty-Second Annual Convention at Saratoga.\*

The association met at Saratoga, N. Y., June 15, with a large attendance. President Crone in the chair and Secretary Cloud at his desk. Prayer was offered by Bishop Newman, and an address of welcome given by Village President Knapp, the response to which was made by President Crone. Railroad Commissioner Cole, of the state of New York, then gave a pleasant and instructive address on general railway topics, covering especially the coupler and brake situation as affected by legislation in the state of New York. Mr. J. H. McConnell, of the Union Pacific, responded to Mr. Cole's address, in a few well chosen words. Then came President Crone's annual address, the substance of which is elsewhere given.

The secretary's and treasurer's reports followed, showing that the association now has 263 active members, 189 representative members and five associate members; also that the funds in hand, with all bills paid, were \$8,245. This excellent financial showing resulted in the voting of a reduction of the dues for the current year from \$5 to \$4.

Associate members were then elected as follows: Edward A. Phillips, editor the Railroad Car Journal, and Walter D. Crosman, editor the RAILWAY MASTER MECHANIC.

#### Supervision of Standards.

In opening the consideration of reports, that of the standing committee on Supervision of Standards was received and after very brief discussion it was voted that the committee's recommendations, as follows, be sent out to letter ballot:

1. Addition to note on Sheets 1 and 2, and on Sheets 4 and 5, to read, "Section of box may be made either circular or square below the center line, provided all the essential dimensions are adhered to."
2. Additional note on Sheets 2 and 5, reading, "When journal box is made of malleable iron, reduction in thickness of metal and coring to lighten weight is permissible, provided all the essential dimensions which affect interchangeability and the proper fitting of contained parts, are adhered to."
3. Reduction of clearance allowed on either side between central lug of brake shoe and adjacent lug to brake head from  $\frac{1}{8}$  in. to  $\frac{1}{16}$  in.
4. On Sheet 9, diameter of release valve rod to be changed from  $\frac{1}{4}$  in. to  $\frac{3}{8}$  in.
5. On Sheet 9, the diameter of truck lever connection for outside hung brakes to be changed from  $\frac{3}{4}$  in. to  $\frac{7}{8}$  in., and note under title on sheet, and reading of text on page 387 to be changed accordingly.
6. On Sheet 9, diameter of hole for cotter in air brake pin to be indicated as 7-16 in.
7. On Sheet 9, addition to note under drawing of truck lever connection for inside hung brakes, as follows: "And if made of round iron or steel must not be less than  $1\frac{1}{2}$  in. diameter."
8. On Sheet 9, omit dummy coupler from drawing and show air hose hanging down.
9. On Sheet 9, omit the words "33 inches or" from dimensions shown for height of air brake pipe above rail.
10. Adoption of axle, journal box and details for cars of 80,000 pounds capacity as an M. C. B. Standard, instead of Recommended Practice.
11. Modification of form of air brake card.
12. Elimination of reference to buffer blocks on page 403.
13. Change in dimensions for radius and diameter of bearing bore gauge, Sheet C, to correspond with dimensions shown in Standard Journal Bearings for  $3\frac{3}{4}$  by 7 in. and  $4\frac{1}{4}$  by 8 in. journals.
14. Elimination of dummy coupling hook from the Recommended Practice.
15. In instructions for stenciling cars substitution for words "Fox trucks" of the words "Pedestal type of trucks."
16. Addition to last paragraph on stenciling cars of the following: "Initials of the road should also appear in letters not less than 2 in. high, on one side of bolster or transom of each truck."
17. Include revised Air Brake and Signal Instructions among Recommended Practices.

The following subjects, recommended by the same committee, were referred to the committee on subjects:

1. Improvement and perfection of standard top hinged lid, so that it may more completely exclude dust from the journal box.
2. To recommend forms of standard journal boxes for  $3\frac{3}{4}$  by 7 in. and  $4\frac{1}{4}$  by 8 in. journals, adapted for use with the pedestal type of freight car truck.
3. M. C. B. automatic couplers. To define length and spread of guard arm, and also consider the devising of a safety limit gage for determining when M. C. B. couplers and knuckles are worn beyond the limit of safety.
4. To revise the Recommended Practice for loading

\*The reports referred to, and the topical discussions that were had at the noon hours, will be found elsewhere in this or our next issue.

poles, logs and bark on cars. [The committee to act with a similar committee of the American Railway Association, which association has asked for a conference committee.]  
5. Specifications for M. C. B. coupler tests.

#### Triple Valve Tests.

The standing committee on Triple Valve Tests reported verbally through Mr. G. W. Rhodes, its chairman. Mr. Rhodes stated that the committee had not been called upon to make any tests of triple valves, and that the members viewed with almost dismay the apparent indifference with which the railway companies were treating the subject of efficiency of triple valves which were being placed in service. He stated that they were fast reaching the condition in which they were before the air brake tests made in 1886, at which time it was revealed by these tests that a considerable amount of apparatus which was being placed in service was absolutely worthless. He stated further that triple valves are at the present time being introduced and placed in actual service which have not been submitted to the committee for tests. The committee, owing to this condition of affairs and the indifference with which the subject in general had been treated, had been considering the advisability of asking that it be abandoned, but had at the earnest solicitation of some of the members of the association decided not to take such action. Mr. Rhodes further stated that the members of the committee were exceedingly desirous that some step should be taken to see that air brake equipment should reach a certain grade of efficiency before it was placed in service.

In discussion of this verbal report Mr. A. M. Waitt indorsed the ideas advanced, and added strong comment, which was in substance as follows: "We are being compelled, on lines of safety, to equip our cars with automatic brakes. It is necessary that these automatic brakes should work in harmony, whatever the device may be in the line of triple valves. We have an able committee which is ready and willing, and has facilities, to test triple valves and report on them. We have certain adopted rules and requirements in connection with what a triple valve must be that have all been carefully worked out, and are in the line of safety and are really necessary for good service. It seems to me that it is fully time that our association took up the results of the tests which this committee has made, and put ourselves on record as holding that the best practice would be for all railroads to accept and use only such triple valves as have been passed upon, and found to be satisfactory, under our rules, by the committee on tests. It would be well if we could have in our printed proceedings, as recommended practice, that those triple valves which have passed the test be named specifically by catalogue number and maker's name, and be known as triple valves which have been accepted for use on the railroads of this country. The moral effect of this would go far to prevent the purchase of the cheapest thing to be bought when new cars are being furnished with air brakes." Mr. A. E. Mitchell indorsed this position and moved that the standing committee on triple valves test all triples in the market and report next year, giving specific names, and referring to catalogue numbers. Mr. P. Leeds urged delay for another year on the ground that present association requirements were carried to a point of extreme refinement and that some of them were possibly not essential. Mr. Johnson urged immediate action; and Mr. Humphrey offered an amendment to Mr. Mitchell's motion, calling for a report from the testing committee as soon as practicable to the executive committee, which should immediately distribute the report to association members. Mr. Mitchell's motion, as thus amended, was carried.

#### Wheel and Track Gauges.

Mr. Potter, of the standing committee on standard wheel and track gauges, stated that there was no report to make. Mr. Barr, chairman of the committee, had been ill nearly all the year; and the especial work which the committee was to have done was rendered impossible by the enforced tearing up of tracks on the Cincinnati & Muskingum Valley, upon which the tests, promised at the last convention, were to have been made. The work would, however, be later taken up.

#### Brake Shoe Tests.

Mr. Bush, for the standing committee on brake shoe tests, reported verbally that no tests had been

made because of lack of material upon which to profitably work. It is possible that during the coming year tests will be made. The association's testing apparatus, hitherto kept at the Westinghous Air Brake Company's works, has been removed to Purdue University, under a very advantageous arrangement with the university authorities.

#### Rust from Salt Water Drippings.

The report on this topic was briefly discussed, with the result of ordering to letter ballot the device noted as No. 1, in the committee's report, for use as recommended practice.

#### Conference with Auditors.

The report of the committee to confer with auditors concerning simpler bills and accounts, submitted a report which was accepted, and the committee discharged. The matters involved were referred to the Railway Accountants' Association.

#### Trains Parting.

The committee on trains parting had no report. Mr. Rhodes deplored this fact in a quite extended talk, in the course of which he said, in substance: "At the present time a law is to go into effect which will affect largely the safety of trains while in service. I have been a little surprised to see the sort of blind confidence that there is connected with the subject of couplings between cars. No one questions the character of the coupling or the kind of material that is put into it, but it seems to me that some one must have confidence that some people are looking after it, and I believe that this blind confidence is in our association. Accidents do occur and whatever perfection we reach, there will still be a class of accidents that may happen and will happen more frequently than others; the one that most frequently occurs is the break in two. \* \* \* Some years ago a good deal of talk was made at our convention because some railroads had put into service cast iron metals, and we introduced a clause in our rules to prevent that, and to show that we discountenanced that kind of material. I have recently seen, and in my vicinity of the country, an M. C. B. bar put in service made of cast iron—the bar itself, and not the knuckle. I do not hesitate to say that any railroad or manufacturing company which will put M. C. B. cast iron bars into service, and less of life results, has committed a criminal act. I propose, for one, if anything of that kind is discovered on the equipment of cars passing over our road, to make it as prominent as possible. I think that is what we should do as members of the M. C. B. association. A movement has been made at this meeting for specifications for draw-bars and couplers. Now let us all get at that with some intention of having some kind of a specification. Let us ask ourselves—How can we have a specification for wheels and specifications for axles and at the same time have no specification for a coupler? We should never put an M. C. B. bar in service without test; and careful records of all break-in-tuos should be kept, so that full knowledge of defective couplers could be had." Mr. A. M. Waitt followed in a similar strain and urged the appointment of a standing committee on coupler tests similar to that on triple tests. He talked especially to the point that coupler wear and distortion should be closely watched and that gages showing the extent of permissible wear should be used.

#### Stenciling Refrigerator Cars.

A committee appointed at the first session to report on stenciling cars recommended that the matter be given to a committee for the next convention. The report was referred to the executive committee.

#### Care of Journal Boxes.

The committee on the best method of packing journal boxes presented a report which was accorded some discussion. Mr. Waitt thought the figure given, of  $2\frac{1}{2}$  hot boxes per thousand miles, to be too high. On his road there was an average of one hot box for every 70,000 miles in passenger service and one box for every 20,000 miles in freight service; and if it were not for foreign cars the mileage would have been four times greater. Eighty per cent of hot boxes on his line were found on foreign cars. Mr. Waitt and others argued for better dust guards. Those who were able to report low percentages of hot boxes had taken special care of them. Mr. Mendenhall used a sectional wooden dust guard, the two parts driven to a tight fit. Mr. Schroyer advocated trimming down the wheel hub to permit of  $\frac{3}{8}$  in. dust guards which will not break. Mr. Leeds thought the trouble lay chiefly with the use of poor

brasses. Referring to oiling Mr. Schroyer urged that the opening at the front of the box should be enlarged, for at present it is impossible to get the oil can spout back to the sides of the journal.

#### Square Bolt Heads.

The report from the joint committee on square bolt heads and nuts and standard pipe fittings, reporting progress and asking continuance, was received, and the committee was continued for another year.

#### Air Hose Specifications.

Mr. Waitt's report on this topic was presented by extended verbal abstract, illustrated by the exhibition of many specimens of hose and hose material. The subject was covered so thoroughly that no discussion was had. The committee was discharged with the understanding that it would be probably called upon to make another report two years hence.

#### Springs for Freight Car Trucks.

The report upon this topic was accepted, without discussion.

#### Thermal Tests for Car Wheels.

The report upon this topic was accepted, without discussion.

#### Revision of Air Brake Signals.

The joint committee on this subject submitted a report, and without discussion the recommendations were ordered sent to letter ballot.

#### Steel Car Framing.

To the surprise of many who were anxious for more exact knowledge concerning steel car framing the committee's report was received practically without discussion. The committee was discharged, as it requested to be in its report.

#### Passenger Car Pedestals and Boxes.

The committee's report on this subject was received without discussion. With the direction that certain errors in the drawings be corrected by the secretary, the committee's recommendations were ordered sent to letter ballot.

#### Final Business.

Notices of amendments to the constitution were given as follows: To allow the railroad commissioners of the different states to become members; to make the regular meeting day the second Wednesday in June instead of the second Tuesday.

Mr. Leeds presented a printed revision of the rules governing the loading of lumber, timber, etc., and it was voted to be sent to a committee which should confer with a committee of the American Railway Association. This revision was recommended by the members of the original committee and by a special committee from Southern roads.

The committee on subjects presented the following list to be considered next year:

- 1st. Standard specifications for lumber in freight car construction.
- 2d. Best design of freight car door fasteners.
- 3d. Standard application of air-brake appliances with a view to reducing the number of couplings in pipes.
- 4th. Best method of applying running-boards and ladders to freight cars.
- 5th. Committee to report on the advisability of allowing a differential or fixing prices for repairs done on work west of the 105th meridian.
- 6th. Perfection of top-hinged oil-box lids, so as to more completely exclude dust from journal boxes.
- 7th. To recommend standard journal boxes 3¾ inches by 7 inches, and 4½ inches by 8 inches adapted to use with the pedestal type of freight car truck.
- 8th. To define length and spread of guard arm, and to consider the devising of a safety limit gauge for determining when M. C. B. couplers and knuckles are worn beyond a limit of safety.
- 9th. To revise the recommended practice of loading poles, logs, bark and other structural material on cars.
- 10th. To report specifications for M. C. B. couplers.

The following officers were elected for the ensuing year: President, C. A. Schroyer; first vice president, John T. Chamberlain; second vice president, J. J. Hennessey; third vice president, W. J. Robertson; executive committee, E. D. Bronner, J. H. McConnell, William Apps; treasurer, G. W. Demarest.

It should be stated in this connection that Mr. Bronner, who was in line for the presidency, declined the honor.

The convention adjourned to meet again in June, 1899, at a point yet to be selected.

#### The Interchange Rules.

The usual alterations in the interchange rules occupied more time than they have for two years past.

The rules had been thoroughly gone over by the clubs and then re-sifted by the arbitration committee; moreover, on the day before the convention took them up the arbitration committee held a fruitful meeting which, by invitation, was participated in by a large number of members. Yet a long time was required to get them into final shape, the greater part of this time being taken up in a futile attempt upon the part of the far west roads to secure a re-adjustment of prices on repairs of cars west of the 105th meridian. The western men made a brave fight at first, giving, in support of the argument, figures showing that the cost of repairs was about 30 per cent in excess of similar costs on eastern lines, and urging a differential of 15 per cent to compensate for this excess. The eastern lines responded with arguments to the effect that as an offset to the extra cost of labor and material in the west, the lines in the latter section were using cars of eastern

that this pin will pass through the gauge when applied up to the shoulder of its head—a distance of five-sixteenths of an inch—the permissible safe variation from contour is indicated. The graduations on the pin show during inspection from time to time, how close to the safe limit the variation is proceeding.

The function of the caliper B is clearly shown by the drawing and its legend. A mark on the body of the gauge shows by register with the indicator end of the caliper, the position of the knuckle face from normal up to a quarter inch variation, which later with the five-sixteenths at A, is the permissible extreme—which is 5¼ in. from edge of knuckle to guard arm.

The projecting arm, or point, C, is used as an alternative with or check upon the caliper. When the gauge is set as shown this projection, C, rests upon the top of the knuckle and when the latter is so far

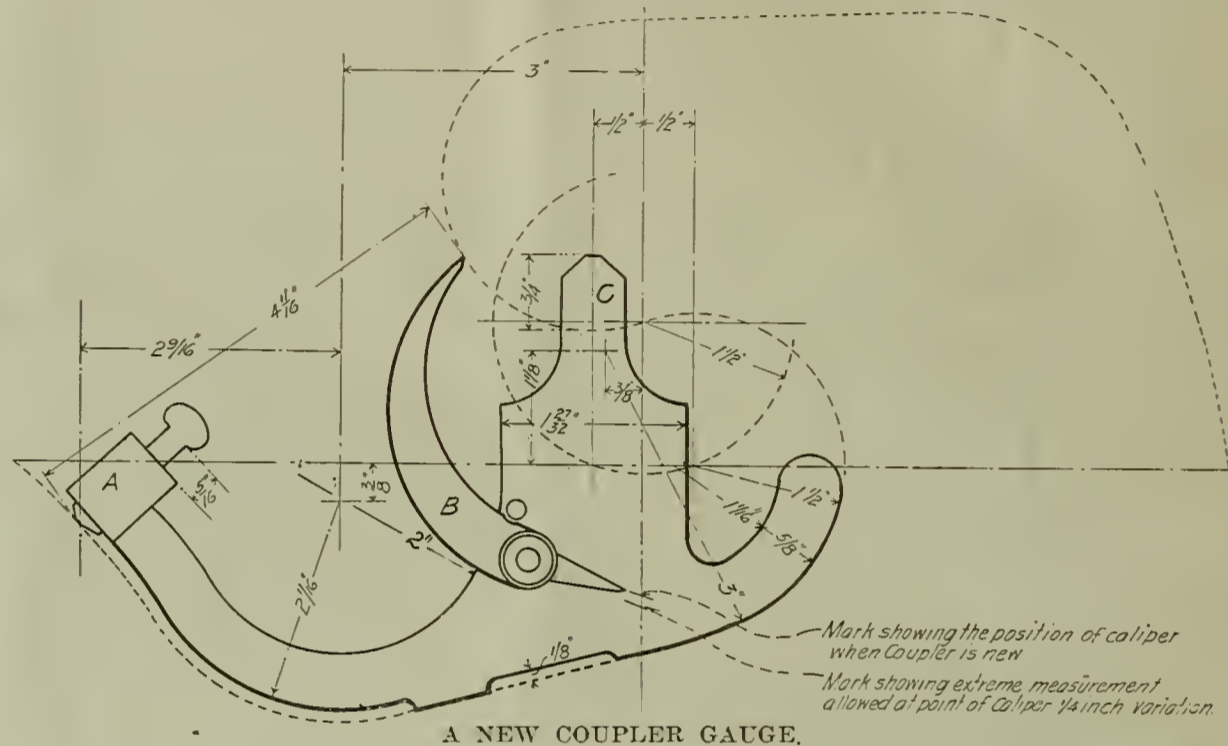

lines at the exceedingly low mileage rate of 6 mills per mile, and were at the same time using more foreign cars than the eastern lines used of their equipment, thus getting a decided benefit, instead of sustaining a loss. The argument was quite hot and quite fully participated in. Finally a proposition came from the west to accept the differential asked for, on private line cars, leaving the eastern railways free from the proposed new burden; but this proposition was generally rejected as unfair to the private lines. Finally Mr Rhodes rose to the occasion, as is his habit, and suggested that this was a very serious matter, so complicated that the committee on prices had found it necessary to leave it alone, and that the convention, unprepared as it was, was not competent to at this time pass final judgment; accordingly he urged that a committee be appointed to investigate the whole matter and report at the next convention. It was, as a result of this sensible stemming of the tide of fruitless oratory, voted that such a committee should be appointed to consist of one member each from the western, the middle and the eastern states, and two members representing private car lines—five in all.

The changes made in the rules were in the usual line; the most important being the adoption of a "blanket" price of \$7.50 for couplers used in repairs, instead of the varying, and frequently excessive, prices hitherto used in billing under the rules.

#### A NEW COUPLER GAUGE.

A coupler gauge that is most admirably adapted to its purposes is shown in the accompanying engraving. It was designed by Mr. Thos. Fildes, division master car builder, at Chicago, of the Lake Shore & Michigan Southern Railway. We give a drawing of the gauge with a superimposed outline (in dotted lines) of the coupler contour. It will be seen that the gauge sets firmly into the face of the jaw, and in so doing presents three points for gauging, A, B, and C. At A the outer arm of the gauge carries a flat graduated pin, with a sliding fit. When the guard arm becomes so deformed or out of line

out of its proper position that this projection will drop inside the knuckle, the permissible safe variation at this point, three quarters of an inch (which is the practical equivalent of the variation of one quarter inch at the point of the caliper, before explained) will have been reached. The large dimension of this projection, C—one and twenty-seven thirty-seconds of an inch—is used for gauging the diameter of the pivotal pin holes.

This gauge has proven its worth and its complete efficiency in daily practice.

#### PRESIDENTS' ADDRESSES AT SARATOGA.

##### Substance of Their Suggestions.

##### By President Crone.

The following recommendations and suggestions are offered for the consideration of the association, in the belief that they are calculated to promote the objects of our organization and to facilitate the transaction of the business for which these conventions are held:

First. I would suggest that section 1 of the by-laws covering the date of meeting or opening day of the convention be changed so as to provide for such opening on the second Wednesday in June instead of the second Tuesday as at present, the former date having been found better suited to serve the general interests besides effecting a considerable saving of valuable time.

Second. I would recommend that the constitution be so changed as to admit one railroad commissioner from each state, upon application, to associate membership, during his term of office; such application to be voted on at the same session at which it may be received. This will admit such commissioner to the privileges of membership at once, thus saving the delay of one year, rendered necessary by the existing provision of the constitution.

Third. A resolution should be adopted at this convention recommending to the interstate commerce commission the advisability of increasing the maximum height of couplers to 35 or 35½ in., experience having demonstrated that three inches variation to cover new cars when empty, and old cars when loaded, is not sufficient. For measuring, adjusting and passing cars, I would suggest, as recommended practice, that loaded cars be ¾ in. below maximum height and empty cars 1 in. above minimum height. This would insure that loaded cars when made empty, and empty cars when loaded, would comply with the law.

Fourth. As the interstate commerce commission has extended the time for the application of Master Car Builders' type of couplers, all companies will be enabled to fulfill the requirements of the safety appliance law, so far as it relates to couplers, and doubtless, a general compliance with the law may be expected in the time prescribed.

Fifth. In consequence of the large number of couplers of the Master Car Builders' type in use, and the vast difference in construction and material used, it would seem desirable that a test be adopted as recommended practice similar to the present test for wheels and axles. This would insure a higher standard of perfection in materials and design.

Sixth. As the rules governing the loading of logs, lumber, structural material, girders, etc., will come up for recommended changes, I would suggest that instructions covering the loading and securing of block stone and rails be included.

Seventh. In cases where the interior of a freight car is damaged by lading, such as acids, oils, etc., I would recommend that the railroad controlling such loading be held responsible, except where special cars are furnished by owners.

Eighth. Owing to the differences of opinions concerning the use of dummy coupling hooks on freight equipment, I would recommend that the matter be referred to letter ballot for decision as to whether this hook should be continued as recommended practice of this association or abandoned.

The large expenditure of money required in equipping cars with air brakes makes it incumbent upon us to provide for securing the most satisfactory results from this outlay. In this connection, I would suggest that some action should be taken in reference to adjustment, either by means of automatic devices or that rules be formulated, which would insure closer adjustment and greater efficiency than is possible under present conditions.

Ninth. To obviate the necessity of correcting bills, as well as to avoid the correcting of books in our auditing departments, I would recommend that a clause be inserted in the rules providing for the use of M. C. B. defect cards for authority to counter-bill where errors may occur on bills. This system has been in operation on a number of the railroads for some time, and results have been very satisfactory.

I would also recommend that standard sizes for bill blanks be adopted.

Tenth. I would respectfully call attention to rule 4 of section 15 of the book of rules. From the different opinions expressed, it would seem desirable to so frame the wording of the section as to make intermediate roads responsible for wrong repairs, unless covered by Master Car Builders' defect or repair card. In connection with this subject, it is suggested that status of joint evidence card should be clearly established in the rules, as to whether, when properly signed, it becomes authority to bill or simply a request for authorization to bill.

Eleventh. I would call attention to my recommendation of last year with reference to repair cards, that these cards should not be issued for wheels, axles or brake shoes, nor for any labor or material not exceeding a sum to be determined by the association, when repairs are properly made. A very great reduction in the number of cards issued would result from such a rule, and, in my opinion, the rule would be more generally complied with.

Twelfth. The noon hour topical discussion is one of the new features of our convention, which serves to bring forth valuable information, and I hope continued interest in this part of our program will be manifested.

The Master Car Builders' Association is perhaps as remarkable for what it does not do as for what it does. Few technical organizations have limited the scope of their operations to those things which are their proper concern. The wisdom of our course in this respect is shown in the practical efficiency which we have reached. The railway equipment of this country is superior to that of any other, and the credit for this superiority is largely due to the Master Car Builders' Association. But we cannot rest entirely upon past achievements. The future will present problems equally as difficult as any we have heretofore encountered. As knowledge comes with experience, our thirty-one years of existence justifies the prophecy that in the coming time, as in the past, "Progress" will be our watchword.

#### By President Leeds.

I regret to say that the scholarships of the association have not been as much sought after as in my opinion they should be. In fact I cannot comprehend the lack of interest displayed. I sincerely hope it is not because our members are disposed to say they will not bring their sons up to follow in their footsteps. To any such I would put the query, in what walk of life is there as true independence as a first-class machinist enjoys? For quite a period, I have been an employer. During that time there has never been a day that there have not been applications for positions on file in my office from competent men for every vacancy of any description, but during that whole time I have never known an occasion when we were not glad to obtain a first-class machinist. Even allowing that the young man should not follow the trade for a permanent means of livelihood or advancement, still is it not well to furnish him with such an acquirement? And while I would not in any way disparage what, in my opinion, is a fact, that any young man who has the natural ability can without such a course master all the essentials of a technical education to fit him for the proper design of machinery, while the executive ability necessary to properly fill a leading position is inherent and cannot be acquired, still, in my opinion, the best method to obtain both a technical and a practical knowledge of our business is through a well equipped technical school, followed by a proper apprenticeship under efficient supervision. In this connection it is my opinion that of two boys equally equipped with natural ability in all respects, except that one has had a regular and systematic training in a school and the other has not, the one with his mind in proper condition for receiving instructions from the start, will make the greatest progress, and his apprenticeship should not of necessity be of as long duration as the other. Do not misunderstand me as saying that this applies to all graduates of technical schools, but if they have the ability a technical education is, in my opinion, a decided advantage.

My predecessor congratulated us that there had been a recognition of the fact that there was no sharp dividing line between theory and practice; and that each, the (so called) practical men and the theoretical men had learned to respect each other. This distinction of practical and theoretical men has always been beyond comprehension. What constitutes either? Does the simple manipulation of tools constitute the practical man? And even in that does he not either form new theories or put in practice those of others that have gone before him, leaving the results as an object lesson for him to profit by? Otherwise why should he serve an apprenticeship? The theorist of the present day is an unknown quantity in actual service. The student is called upon to practically demonstrate his theory, and the only difference is in the method of research.

Education in either line does not always imply valuable knowledge, nor can such knowledge be obtained so well in any other way as by experience and observation in the great laboratory of every day practice. It may be said that there is a great deal taught in the school that is superfluous. To this I cannot agree. Perhaps it is not fully essential that a railroad Master Mechanic should know how to properly lay out the tooth of a gear wheel, still I do not think many of you will claim that this knowledge would work any harm. I repeat that it is a matter of sincere regret to me that only one scholarship has been awarded during the present year, and that not to a son of an employe, but an employe himself.

The matter assigned to your executive committee, together with a special committee, of endeavoring to arrange the time of meetings of the two associations so that members of both could attend without too much loss of time could not be handled in strict accordance with instructions, inasmuch as the president of our sister association did not consider the method proposed the proper manner to bring this matter before that body, and refused to convene the executive committee for conference, at the same time the officials assumed the responsibility of changing the dates of convening so as to shorten the time as much as possible. The consideration of this matter has firmly established in my mind the opinion that if there ever existed a need for two associations, that necessity has passed. The members of either being eligible for membership in the other, and their duties of research and advancement being not only identical but to a very great extent carried on by members of both associations, the two associations should be consolidated for the mutual advantage of not only the members but of the railroads. Of the members of this association who do not appear in the M. C. B. membership, a very large majority are master mechanics who have an interest in, and control, car departments, as well as motive power; yet they are represented by one member for the whole railroad system by which they are employed. For instance, I represent our road, yet most assuredly the ten master mechanics employed by us are just as much interested in the maintenance of our equipment as though they bore the title of master car builder. If the two associations were combined the work could be done with much less loss of time. For instance, two days are given to the opening. The election of officers and other incidental work consumes about all of two days. All this could and would be condensed into one day for each, and thus save two days; and if our work was largely done by committees, as in my opinion it should be, one week would suffice for the actual attendance. Besides this, in my opinion, a great deal better results could be obtained by one organization as strong as this would be, than can possibly be by the two.

It has for many years been my idea that all equipment that is interchanged should be considered as common equipment of the country, and be as uniform in construction as the standards of any one road. This can only be achieved by the recognition of a common bureau or head, on the same principle that the head of a department decides the standards for a system. It is scarcely probable that all designs originate with that one head, but far more probable that it is the result of suggestions of many, so, in case a committee was appointed by the organization, they would receive suggestions from all, and nearly every one would have good reasons to advance for his manner of construction, and if this committee had one or two experts employed to analyze all such ideas as were presented, and to investigate reports of facts gathered from observation, they should be better enabled to recommend standards for all classes of interchange than a committee who undertake such investigation in addition to their other manifold duties, and (may I whisper it?) further hampered by the idea that theirs are the only methods worthy of adoption.

Another thing this association should be the fountain to furnish information as to what type and size of motive power is best suited to certain service under special, or varied conditions. This, in my opinion, can best be obtained by comparative tests, under close observation of the work performed by the various types in actual service by unprejudiced parties, and I know of no method by which this could be as well accomplished as by the appointment of a committee who by their mechanical skill and practical knowledge of all the requirements, were capable of judging of the merits of such matters when presented, and empowering them to employ such experts as necessary to collect data and outline suggestions of what should be adopted as standard for all interchange equipment, and to make such practical comparative tests of power as directed, making a summarized report to them.

#### Where to go Fishing.

A great many readers of the RAILWAY MASTER MECHANIC are now planning for their vacations, and a goodly percentage of them mean to go a-fishing. Good luck to them, one and all! May every man and woman of them catch just fish enough for excitement and reasonable satisfaction, and may there not be a single "fish hog" among them all. May they get out of their fishing all there is in it besides catching fish.

We know something of the district of which Fifield, Wis., on the Wisconsin Central railroad, is the center, and can testify that there is rest for the weary in those regions. Eastward from Fifield lies Pike lake, one in a necklace of lakes, the breeding places from time immemorial of muscallonge and pike and bass. Westward, and not so far from the same station, is the Mason Park group of lakes, equally well stocked for the fisherman. One of these, Long lake, on which the little hotel is situated, is three miles long, a half mile or more wide, and 50 or more feet deep, and is fed entirely by springs. It has no inlet and the water in some places is almost as clear as air. Its banks are high, with no margins of marsh and are densely wooded. In such a place the true fisherman catches much more than fish. The pines have been mostly cut out, but that was done many years ago and nature has healed all gashes and filled all the empty spaces. Morning, noon and night the forest is full of shadows. The hemlock, the maples, the beeches, the balsams and spruces and the quivering aspens are all in their places. Whatever way the wind may come from it is sweet with unbreathed air, and fragrant with untainted forest odors. The nights

are cool with whisperings of trees which make sleep early and profound.

No one who visits these regions will go amiss, and all the time taken in doing so will more than be made up next fall and winter by the extra vitality obtained by living close to nature and absorbing strength from her infinite energies.

#### THE MASTER MECHANICS' ASSOCIATION.

##### Proceedings of the Thirty-First Annual Convention, at Saratoga.\*

The association met at Saratoga, June 20. President Leeds in the chair, Secretary Cloud at his desk, and a large number of members in attendance. Prayer was offered by Bishop Newman.

President Leeds followed with his annual address, the substance of which is given elsewhere.

The secretary's report showed the association to now have 598 active members, 18 associate members and 26 honorary members—a total of 642.

Mr. G. M. Basford, editor of the American Engineer, and Mr. E. C. Bates of the Crosby Steam Gate & Valve Co., were elected associate members. The following honorary members were elected: M. N. Forney, E. L. Coster, J. I. Kinsey and J. McGlenn.

##### Tonnage Rating.

The admirable report upon tonnage rating covered apparently a topic too difficult for ready discussion. Nevertheless there was a little talk upon it, chiefly directed to such questions as the feasibility of using actual weights instead of way bill and stenciled weights, and as to the blind following of road profiles known to be old, the point being as to the latter, that profiles were continually changing.

##### Boiler and Cylinder Insulation.

This report was received with considerable interest, but was only briefly discussed, several members simply detailing the methods employed by them in the use of various forms of covering.

##### Square Bolt Heads and Nuts.

The joint committee on this subject, covering also the matter of standards for pipe fittings, reported progress and asked for more time, for further conference with the Master Car Builders and with the American Society of Mechanical Engineers, which was granted.

##### Advantages of Improved Tools.

This report was printed after the convention opened, and no one was, apparently, prepared to thoroughly discuss it. With a few words of unimportant comment the topic was passed.

##### Efficiency of High Steam Pressures.

This important topic was given valuable discussion, which we will present quite fully in our next issue. The topic was referred to the committee on subjects, the desire being to have another report a year later, to be based upon more extended experience with the higher pressures.

##### Best Form of Cylinder Fastenings.

This report, which was supplemented by another report from Mr. J. E. Sague of the committee, was received with practically no discussion.

##### Air Brake and Signal Construction.

The joint report on this topic was adopted, and it was voted that when the Master Car Builders approved it as "recommended practice," it should be printed as approved by the Master Mechanics' Association.

##### The Apprentice Boy.

The standing committee on apprentice boys rendered a report which was accorded but brief discussion. The code proposed by the committee was not adopted as a standard, but was formally approved as a recommendation of the association, and the committee was discharged.

##### Consolidation of the Two Associations.

A committee, consisting of J. H. Setchel, A. M. Waitt and P. H. Peck, appointed early during the sessions to report upon the recommendations made in President Leeds' address, tendered the following report, which, because of its special importance, we give in full:

Your committee to whom was referred the recommendations made in the president's annual address would respectfully beg leave to report: That we believe the suggestions made therein as to a consolida-

\*The reports referred to, and the topical discussions that were had at the noon hours, will be found elsewhere in this or our next issue.

tion of the two associations under one organization are wise and timely made, and should be carried into effect at the earliest practicable period

A large percentage of the car mileage representation in the car builders' association is controlled by superintendents of motive power or master mechanics who are members of the Master Mechanics' Association in which all master car builders are eligible to membership, and there would, therefore, seem to be no good reason why all business pertaining to construction and repairs of railway rolling stock, whether of engines or cars, should not be transacted in one association and at one convention. Fully one-half of the time of members from duty would be saved, and an equal amount of expenses to the railroads. With one organization the business which now takes practically two weeks would be accomplished in one, and the six days now spent in convention can be reduced to four, and fully as much work accomplished.

The successful merging of the two associations would then render it quite possible under proper restrictions to carry out the suggestions of the president looking to the establishing of an interchange of motive power equipment in certain localities, as well making it advisable to appoint a standing committee for conducting tests, and indicating to members the necessary requirements for interchange of motive power.

Your committee do not suggest that the combined organization should retain the name either of the two present associations, for we believe a more suitable and comprehensive one may be found that will give entire satisfaction. But your committee do recommend, and we do believe, that railroad managers will insist that the supervision of railway rolling stock now exercised by the associations shall be placed under one organization.

Your committee would therefore recommend that the executive committee of this association be and are hereby instructed to at once confer with the executive committee of the Master Car Builders' Association and endeavor to arrange for a consolidation of the two associations under such name and conditions of membership as will do full justice to both associations and accomplish this very desirable object, and the president of this association is authorized and directed to appoint a special committee, who shall also be members of the Master Car Builders' Association, to attend the next annual meeting of the Master Car Builders and present this subject for consideration.

This report was unanimously adopted.

### Subjects for 1899.

The committee on subjects for the next convention reported the following list:

1. A research laboratory under the control of the American Railway Master Mechanics' Association.
  2. Water purification and the use of a boiler purge.
  3. Cast iron vs. steel-tired wheels for passenger equipment.
  4. The advantages of the ton-mile basis for motive power statistics.
  5. What is the best method of applying stay bolts to locomotive boilers, including making the bolts and preparing the stay bolt holes?
  6. Is it advisable to have flange tires on all the drivers of mogul, ten-wheel, and consolidation engines? If so, with what clearance should they be set?
  7. Is it good practice to make locomotive fire boxes with the crown and side sheets in one piece?
  8. The use of nickel steel in locomotive construction; its advantages and proper proportion of nickel.
- After election of the following officers the convention then adjourned: President, Robert Quayle; first vice president, J. H. McConnell; second vice president, W. S. Morris; third vice president, A. M. Waitt; treasurer, J. N. Barr.

### EFFICIENCY OF HIGH STEAM PRESSURE FOR LOCOMOTIVES.\*

1. At the time this committee was appointed, it was expected that the experimental locomotive at Purdue University would serve to give sufficient data to permit the presentation of a report dealing entirely with experimental facts. Unexpected delays have been met and the problem has proved to be an extensive one. While more than thirty tests have been run, the full significance of the data obtained cannot be known until it is supplemented by information yet to be supplied. For this reason it has been thought best to withhold the experimental data thus far obtained until the investigations shall have developed definite conclusions. Some reference may, however, be made to the tendencies disclosed by the work already accomplished and a general discussion of the question may be introduced.

2. The locomotive with which the two Stephensons competed for and won the prize at Rainhill carried a steam pressure of fifty pounds per square inch.† This was seventy years ago. Since the time of the Rocket, the pressure

\*Report at the Master Mechanics' convention. The appendices referred to will be given later.—Ed.  
†Smiles' "George and Robert Stephenson," page 217.

on locomotive boilers has been gradually increasing, and today practice in America involves the use of pressures which fall between the limits of 140 pounds and 200 pounds. While many locomotives are running under pressure which are near the lower limit, few are now being built which are designed to carry less than 180 pounds and a pressure of 200 pounds has ceased to be uncommon. What lessons are to be derived from the experiences of the past, and to what extent are they to be relied upon to guide the practice of the future? Will the tendencies which have manifested themselves in the past continue to prevail? Are we to look for a gradual increase beyond 200 pounds, or has the maximum limit already been reached? These are the important questions which naturally suggest themselves in connection with the subject which is to be presented by this report.

3. **POWER AND EFFICIENCY.**—The power developed by a locomotive is a measure of the work done by the steam in the cylinders; it is a function of pressure, steam distribution, diameter and travel of piston, and of speed. The efficiency of a locomotive is a measure of the degree of perfection attending the development of power; concisely stated, it is the ratio of the heat equivalent of the work done in the cylinders, to the heat supplied in the fire box. That engine is most efficient which, for each pound of coal burned, develops the largest amount of power in the cylinders.

Anything which affects the efficiency either of the boiler or of the engines of a locomotive affects the efficiency of the locomotive as a whole. Boiler efficiency depends upon the proportions of the boiler and the rate of power to which it is worked, while engine efficiency depends upon many factors of which initial pressure is but one. Whatever gain in efficiency is to be derived from the use of higher steam pressure in locomotives is, therefore, to be found in the improved performance of the engine. An ideal engine will always give increased efficiency in return for increase of pressure, but the actual engine may or may not do so. (Appendix I.)

While the term "efficiency" should not be confused with "power," these terms express facts which, in a locomotive, are closely related. Under normal conditions, a locomotive is worked so near its maximum power that the limit of power is determined by the amount of coal it can burn. If improvement can be had in the process of combustion, or in the more complete absorption of heat by the heating surfaces, or by a reduction in the amount of fuel lost as sparks, the efficiency of the boiler will be increased, and at the limit of power this improvement in performance can be converted into an increase of power. Again, if the cylinders can be made to better utilize the heat supplied them, they may with a given amount of steam be made to yield greater power. It is safe, therefore, in summarizing these statements to say that anything which will operate to improve the efficiency of a locomotive may be employed as a means for increasing its power. If, therefore, increased pressure increases efficiency, it is clear that every interest will be served by its adoption.

4. **PRESSURE A SINGLE FACTOR AFFECTING EFFICIENCY.**—There can be no question but that the gradual increase of pressure which has been developing itself for many years past, has been accompanied by increased engine efficiency. It is, however, probably true that much of the improvement which has been observed is the result of betterments in mechanism, as well as of advance in the direction of pressure. This fact makes it desirable to emphasize at this point a matter to which brief reference has already been made, namely, that pressure constitutes but a single factor affecting the performance of an engine. Equally important with pressure are questions of valve proportions and of valve setting, of cylinder clearance, and of degree of expansion. Moreover, the significance of all of these factors is increased as the pressure is increased. Great improvement in efficiency, therefore, should not be expected as the result of attention given to the matter of pressure alone. On the contrary, it should be assumed that each increase of pressure is a demand for greater refinement in the mechanism of the engine. The valve action must be positive and must give a good distribution of steam at short cut-offs; the cylinder clearance must be minimum, the extent of surface honing and the clearance volume must be held to its lowest limits, and as pressure increases, compound cylinders must be used. With such attention to details, it is probable that each increase of pressure will be found to contribute its share to the progress of the future. (Appendix IV.)

There are those who view the situation to-day with the feeling that increase of pressure, being rather easily obtained, has advanced more rapidly than other measures affecting the efficiency of the locomotive. They assert that time must be had in which to perfect other details before further advances in pressure are made. If this position is true, it is likely that as in marine practice an advance in boiler pressures awaits a general adoption of the water-tube boiler, so in locomotive practice a further advance in pressure awaits the more general advent of the compound engine. (Appendix II.)

It is frequently assumed that the process of gradually increasing pressure beyond limits now common will soon reach a point beyond which it will be found impracticable to go. Difficulties in maintaining a satisfactory condition of lubrication, in using soft metal packing, and in using water glasses under pressures which much exceed 200 pounds are often cited in this connection. It would appear, however, from experience already had in marine work, that none of the difficulties are such as will block the way to the adoption of higher pressures whenever it shall be demonstrated that higher pressures are needed to further increase the efficiency of our locomotives.

5. **HIGH PRESSURE ON SIMPLE LOCOMOTIVES.**—The term "high pressure," as employed in this paragraph, refers to pressures above 160 pounds. The effect of such pressures on the performance of non-compound locomotives is now to be considered. The arguments for and against their adoption may be summarized as follows: (See table next column).

It is assumed that, other things being equal, the evaporative efficiency of the boiler will not be changed by such modifications as are necessary to enable it to withstand increase of pressure; the evaporative efficiency does not, therefore, appear as a factor on either side of the argument.

It is assumed also that cost of lubrication and of repairs to boiler and engine do not necessarily change with changes in steam pressure. (Appendix III.)

Reviewing the arguments as summarized above, it is to be noted that the important factor favoring the adoption of higher pressure is the possible economy which is expected to result. The other advantages are incidental, and while some of them may have great weight in particu-

lar cases, their significance in the general case merits but slight attention.

IN FAVOR OF HIGHER PRESSURES.	AGAINST HIGHER PRESSURES.
1. Smaller cylinders, and consequently lighter reciprocating parts.	1. Increased weight of boiler.
2. Reduced width of engine outside of cylinders.	2. Increased first cost of boiler.
3. Reduced first cost of engine.	3. Increased transportation charge, due to increased weight of boiler.
4. Reduced transportation charge because of reduced weight.	4. Probable increase in small heat losses, as from radiation and from leakage past valves and glands.
5. A possible gain in the efficiency of the engine, whereby a given power is developed on less steam and on less fuel than could have been done with a lower pressure.	

The economy which is to result from an increase of pressure must be sufficient to balance all of the considerations which in the foregoing summary appear against the adoption of such pressures. It is evident that unless the gain in efficiency is material, the net result of increasing pressure will be disappointing.

In this connection it will be profitable to review briefly the results of tests run under different pressures on the experimental locomotive of Purdue University. This locomotive carries 250 pounds pressure; its cylinders, having been constructed for special investigation, have an unusually large clearance, and at the time of the tests the valve setting gave excessive lead at very short cut-off. It is significant that these defects were sufficient in their effect to more than neutralize the gain which might otherwise have resulted from the use of higher pressures. It is, in fact, so easy to fail in securing the anticipated gain from increase of pressure, through some minor defect of design or adjustment, as to make it probable that the most economical pressure for simple engines, in their present stage of development, is within the limits of present practice. (Appendix IV.)

6. **HIGH STEAM PRESSURES FOR COMPOUND LOCOMOTIVES.**—It has already been argued that compounding is a means to the economical employment of high steam pressures, from which it follows that the maximum pressure for compounds is higher than for simple. Existing data is insufficient to serve as a basis for any prediction as to the effect of excessive increments of pressure upon the efficiency of compounds of existing types.

7. **HIGH PRESSURES AND ENGINE DIMENSIONS.**—As is well known, the volume of the cylinders of an engine which is to develop a given power is, other things being equal, inversely proportional to the available pressure. As the steam pressure is increased the size of the cylinders may be reduced. On many roads, the width of engines over cylinders is already very close to the clearance width along the right of way. On such roads a demand for engines of greater power cannot be met by increasing the diameter of cylinders; hence, resort must be had either to a longer stroke of piston or to higher steam pressure. Demands of this nature will unquestionably stimulate a tendency to the employment of higher pressures, and the end will justify the means.

8. **BOILER PRESSURE vs. BOILER CAPACITY.**—It is not the purpose of this report to enter upon a general discussion of conditions affecting locomotive efficiency, but the question of boiler pressure is so closely associated with that of boiler capacity that a brief reference to the latter subject seems desirable.

The preceding discussion discloses the fact that the proposition to improve the economy of a simple locomotive by increasing pressure beyond present limits is of doubtful value. When viewed as one of several expedients which are open for adoption, it is manifestly not of first importance. For example, within limits now common, an increase in boiler capacity offers a way to increased efficiency which is both sure and significant. If, for example, it is desirable to increase the efficiency of a locomotive now carrying 140 pounds of steam, by giving it a new boiler of the same dimensions with the old, but designed for a pressure of 200 pounds, the effect produced will be entirely due to increase of pressure. The economy resulting cannot be large, and may, as in the case of experiments already cited, amount to nothing. The new boiler may weigh, approximately, 5000 pounds more than the old. Now, it can be shown that if, instead of adding to the weight of the locomotive by making a stronger boiler, the same increase of weight had been applied to making a larger boiler, the resulting economy would not fail to be material. (Appendix V.)

WILLIAM F. M. GOSS,  
WILLIAM FORSITH,  
TRACY LYON,  
Committee.

### CAR TRACK DESIGN.

At the Master Car Builders' convention at Saratoga, June 15th, one of the topics for discussion was "Trucks for Cars of 60,000, 80,000, and 100,000 lbs. Capacity." The discussion was opened by Mr. Bronner, as follows:

Topic 5 is rather a broad question to handle on short notice and in a limited time. On account of the short notice, I was unable to secure definite statistics and statements of experience from the membership and will, therefore, be obliged to rely on my own experience and what few statistics I had on hand. Many of our members have had large experience with metal trucks of various forms and will undoubtedly be able to add to the interest and value of the discussion. The first sub-head is as follows:

1. "To consider the advisability of the Master Car Builders' Association adopting standard trucks for cars of these capacities, or the possible adoption of standard parts, with a view of decreasing the number of parts now used."

As long as I can remember anything of association affairs the question of standard trucks has periodically been a subject for committee work and discussion. I remember 15 years back when I was in the draughting office that I put in considerable time working on drawings for my chief, who was on such a committee. Coming down to more modern times, we find an able report to the association in 1893. Their recommendations were:

1. "Uniformity in dimensions (except length) of materials used in arch bars and tie bars. Transom and bolster truss rods, oil box and column bolts, side bearings and center plate bolts; spring steel used in elliptic springs, iron and steel transoms."

2. "Truck bolsters made and designed with a sufficient factor of safety to carry the marked capacity of the car without deflection enough to disturb free action of the side bearings."

3. "That many of the trucks need to be redesigned with a view of diminishing the number of parts fully twenty-five per cent, thereby reducing first cost and maintenance."

The strong tendency at the present time seems to bear out their opinion of the requirements as expressed in recommendation number 2.

The wisdom of recommendation 3 can not be disputed, and it also appears to be bearing fruit. In 1894 we had another report. In its summary the committee states "it considers it useless to recommend special designs for arch bars as it would not be approved by the association, as there seems to be no uniformity in this particular. For the same reason it did not consider it advisable to make recommendations for standard channel transoms. As a result of the report, the following recommendations were submitted to letter ballot as recommended practice.

- Upper arch bar, 60,000 trucks..... 1 1/4 x 4 in.
- Lower arch bar, 60,000 trucks..... 1 x 4 in.
- Tie bar..... 5/8 x 4 in.
- Wheel base..... 5 ft x 2 in.

These were rejected by the association.

In 1897 we had another truck report. The committee showed by diagram the great variation in set of arch bars, etc., in the 60,000 trucks in use and came to the conclusions that it would be impossible to recommend a standard design. As a result of the committee's work, however, a design for arch bars for 80,000 pound cars was adopted by the association as recommended practice showing:

- Top arch bar..... 1 1/2 x 4 1/2 in.
- Lower arch bar..... 1 3/8 x 4 1/2 in.
- Tie bar..... 5/8 x 4 1/2 in.
- Wheel base..... 5 ft. 2 in.
- Column bolt..... 1 1/8 in. diam.

Why was it that the design for 60,000 lb. arch bars submitted in 1894 was rejected and the design for 80,000 lb. arch bars submitted in 1897 was adopted, the former being apparently just as good a design for the purpose as the latter?

In the case of the 80,000 pound arch bars, we took time by the forelock. There were very few 80,000 lb. trucks in existence, and nobody was prejudiced in favor of his own design. In the case of the 60,000 pound bars there were many designs used very extensively, and it was impossible to reach a compromise. Everybody wanted his own design or nothing.

The lesson to be learned is that the easiest time to adopt designs is a little in advance of the times. I refer, of course, to mere enlargement of well-known practice and not to entirely new ideas.

Standard trucks for freight cars of 60,000, 80,000 and 100,000 pounds capacity has an alluring sound. In thinking the matter over the question arises, Would it be possible to adopt them? Would it be the best thing for the future—practically, what would it amount to?

First—Judging from past experience, I should say that we cannot agree on a standard, and even if we were to adopt a recommended practice it would not be largely used.

Second—A standard adopted and fully recognized would impede progress.

Third—It would amount to very little in the end, as the practical results sought could be largely accomplished by the adoption of standard parts.

To determine what the parts are that fail largely, I have analyzed the truck repairs on our road for one month. These are the running repairs made at outside repair stations, and do not include heavy repair at shops. The total number of cars receiving repairs of any kind was 9864.

The truck repairs were divided as follows:

Wheels and axles (including journal bearings in a majority of cases).....	825
Journal bearings only.....	988
Journal bearings, wedge.....	57
Journal box bolts (about 72 per cent alone).....	317
Truck column bolts.....	173
Truck column guide bolts.....	163
Arch bars.....	86
Tie bars.....	4
Swing hanger pivot casting bolts.....	2
Bolts in Fox truck (jaw).....	2
Swing hammer.....	31
Swing hanger pivot.....	17
Center pins.....	273

Truck truss rods.....	39
Journal box.....	42
Journal box covers.....	14
Truck column.....	27
Bolster guide block.....	20
Swing hanger pivot casting.....	25
Swing hanger casting.....	4
Spring plank casting.....	8
Truck holster chafing plate.....	3
Truck bolster.....	34
Truck transom.....	15
Spring plank.....	25
Truck springs.....	40
Nuts without number.....	

3,234

It will be seen that a large percentage of the repairs is on account of wheels and axles, journal bearings, journal boxes and covers, journal bearing wedges and journal box bolts. These we have standardized for several classes of trucks, and if they were adopted and used by all of our members it would obviate much of the difficulty in making truck repairs. On the whole, I shall say, let us give up "rainbow chasing" and save time and labor spent in trying to adopt standard trucks.

If we can get standard wheels and axles, journals bearings and wedges, journal boxes (which determine their bolts) and possibly standard cross sections for arch bars and diameter of column bolts for 60,000, 80,000, and 100,000 pound trucks, we will get all we can ever hope to compromise on in the present stage of the car builder's art, and practically all that will be necessary.

2. "The relative efficiency of metal trucks of various forms as compared with each other and with the diamond truck, comprehending the cost of maintenance, the effect on wheels and journals, and as regards safety."

A great many designs for metal freight car trucks have been brought out, but my experience has been limited to two general classes—the type represented by the Fox, Cloud, Schoen and Hewitt trucks and the variations of the old diamond type of truck brought about by the introduction of metal trucks. The relative efficiency of those of the first type as compared with each other would be a difficult matter to determine, and not having any data upon which to base a conclusion I will leave the point for discussion by others who may feel themselves more competent or many have had the trucks under their observation.

With both kinds of trucks the function performed is to sustain the weight on the centre and distribute it to the journal boxes. The trucks must do this over good surface and bad surface, over curves and tangents, at low speed and at high speed. To do this efficiently the truck must retain its shape in all respects under the shocks and strains it is subjected to. It must remain square to keep the flange wear of the wheels and the train resistance at a minimum. The cross girders or bolsters must show little deflection so that too much weight will not be thrown onto the side bearings and thus increase the resistance to curvature. The transverse strength of the cross girders, transoms or bolsters must be sufficient to resist the shocks of sudden applications of the brakes and buffing. The wheel shock must be cushioned in a manner to produce the least detrimental effect on the structure of the truck or body and also the track. It should be of such design, construction and material that failure of parts will be reduced to a minimum. Failure in detail increases cost of maintenance and decreases safety. It should not have too many vital parts which might, by the failure of any one, wreck the truck, the car or the train.

We must also consider the facility and ease of inspection and repairs or replacements of parts subject to wear. The modern diamond frame truck, either rigid or swing motion, constructed entirely of metal, more nearly meets these requirements than its predecessor constructed largely of wood and with gray iron castings. The metal bolsters and channels are more rigid and less liable to sagging, decay and failure. The introduction of malleable iron parts has also resulted in a decrease of failure of those parts. But let us examine the repair records and see what are the weaknesses of the diamond truck, and whether these improvements would eliminate them. We find that the various wrought iron parts and bolts still remain, that the truck still depends upon too many vital parts, that it is still subject to failure in detail.

It might be said that the larger and heavier parts in the modern trucks will resist more effectually the shock and strains that they are subject to. In this conclusion I think that we would be largely in error, as there have been many well designed trucks under our older and smaller capacity cars, which were fully as good for their class, barring the metal bolster, as the trucks under our large capacity cars. The latter are merely an enlargement to meet the greater carrying capacity of the cars and still embody all the vital parts and probably most of their weaknesses. These parts are failing as in the past, and these failures will increase as the cars get older and the carrying capacity greater.

The diamond frame type of truck was a better type for small capacity cars than it will be for 60,000, 80,000 or 100,000 pounds capacity cars. The frame is

still subjected to all the wheel shock uncushioned and the strains induced by trying to force four wheels held in a rigid frame into contact with rail surfaces not lying in a plane. With our 60,000 and 80,000 pound trucks, we retain the same wheel base as in our lighter trucks, but enlarge and stiffen the parts to carry the increased load, thus robbing them of a certain amount of elasticity which the lighter trucks possessed; otherwise I am unable to understand the large number of failures of arch bars in diamond trucks of large capacity and heavy parts which I have noted. In the matter of inspection it is true that the arch bar truck permits an easier inspection of wheels than a plate truck, but the frame of a plate truck having so few vital parts, and being subject to so few failures, requires less time for inspectors and permits more time to be devoted to the wheels.

In the matter of repairs the replacement of wheels requires more time in a truck with jaws than in the diamond truck, even considering the time consumed in handling inside wheels and rusty box bolts, but in weighing the matter we must remember the length of life of wheels in freight service.

From my point of view, a plate truck of the type represented by the Fox, Cloud and Hewitt trucks is the most efficient truck for cars of large capacity. Properly designed and built in a proper manner with the right material, they will retain their shape in service, thus reducing train structure and flange wear. The cushioning of the entire structure above the journal boxes decreases cost of maintenance.

To come down to practical facts, the road I am connected with owns but fifty cars equipped with Fox trucks, but we handle N. Y. C., Erie and L. V. cars equipped with these trucks in large numbers, so that our men are perfectly familiar with them. The only failures that have occurred on our lines were two cases when the trucks first came out. The side girders failed, beginning with a fracture at the bottom flange, near the cross girder, and passing up through the rivet holes. It developed gradually. Since then we have had practically no running repairs to frames whatever, on the many thousands of these trucks which we have handled. Our foremen all report satisfactory service for all such trucks coming under their observation. We know that the earlier designs developed some weakness and have been changed once or twice, and for all I know, when they get home to the owners they may be like the "old one hoss shay" and break down all at once, but we have never seen anything of it. The type of truck is what I am referring to, although in talking of my practical experience with the type I am obliged to handle a particular one. It may be that none of the trucks of that type now in service are just right, but I firmly believe that the most efficient trucks for the service lies along those lines, and that it can be built to last.

The body bolster is fully of as much importance as the truck bolster, although more attention has been centered in the latter. It is of little benefit to get a rigid truck bolster if your body bolster sags and permits too much weight to be carried on the side bearings, as side bearings are generally constructed. Go through any railroad yard and what do you see? Body bolsters all sagged at the ends, especially the wooden ones. A wooden body bolster can no more be preserved in line in practical service than a wooden truck bolster can.

## Reports of the Master Car Builders.

### SPRINGS FOR FREIGHT CAR TRUCK

Your committee, to whom the work of recommending designs for standard freight car truck springs was assigned, after having given the subject a careful study, and profiting by previous work done by committees in the different railway clubs, practical experience, suggestions of spring manufacturers and railroad officials who have studied this question, report as follows:

The chief aim of the committee has been to submit such designs as are practical and economical, in order that, in case of adoption, they may not become a dead letter, but serve the purpose for which they were designed. Standard springs, to be desirable, must be so designed as to best satisfy the following conditions:

1. The springs must be generally applicable to the majority of the existing cars, without expensive alterations in their application.

2. They must be so designed that they will not increase the cost of maintenance by premature failure or excessive first cost.

3. There should be a minimum number of different coils, and the different coils should be so made as to be readily distinguished one from the other, so as to prevent confusion and mistakes in application, and to reduce the cost of stock necessary to be carried for prompt repairs to both foreign and individual cars of usual design.

4. All coils used for outside bars to be wound right-

handed, and the inner coils to be wound left handed, to prevent interlocking.

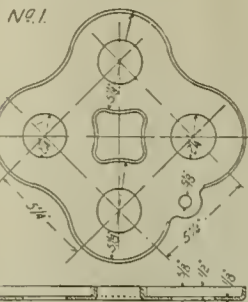

M.C.B.  
PROPOSED STANDARD  
SPRING CAPS  
FOR  
FREIGHT CAR TRUCKS.

Used on arch bar trucks for cars of 40,000, 50,000 or 60,000 lbs capacity, with groups of four coils, with or without inner coils as required by capacity of car and as indicative in schedule.

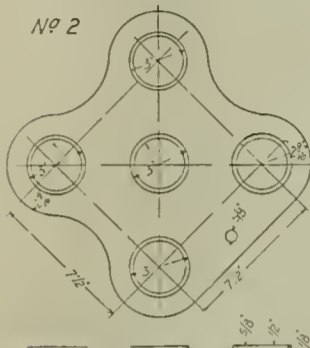

Used on arch bar trucks for cars of 50,000 lbs capacity with groups of five coils

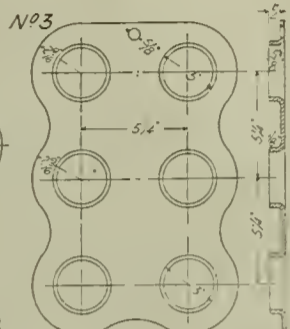

Used on arch bar trucks for cars of 60,000 lbs capacity with groups of six coils

In the designing of these springs it has not been considered necessary to consider cars of less capacity than 40,000 lbs., nor does there seem to be occasion to consider a spring for pedestal trucks for cars of less than 50,000 lbs. capacity, as such cars are few in number, and are not likely to be perpetuated. The fact that there is no M. C. B. standard journal box for 90,000 or 100,000 pounds capacity cars, debar the consideration of springs for cars over 80,000 pounds capacity for the present. These can be considered in time to come, when more of these cars are in existence, and some standard journal box is adopted. It was considered desirable that the springs and plates for use with the cars at 40,000 pounds capacity should be available for use under 50,000 and 60,000 pounds capacity cars, so that there will be no loss at such time as the 40,000 pounds cars cease to exist

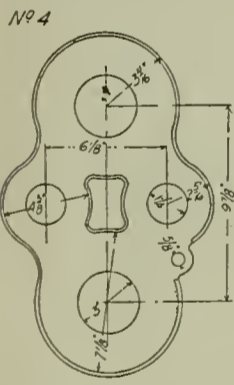

Used on arch bar trucks for cars of 70,000 lbs capacity, with groups of four coils.

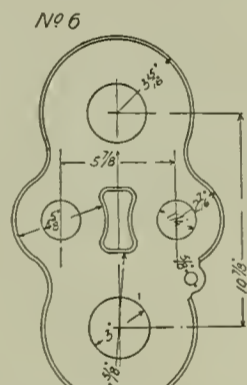

Used on arch bar trucks for cars of 80,000 lbs capacity with groups of four coils.

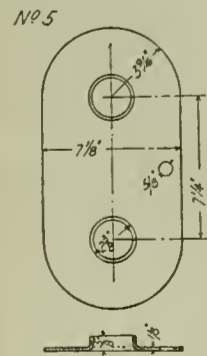

Same as No. 4 but with groups of two coils with inner coils.

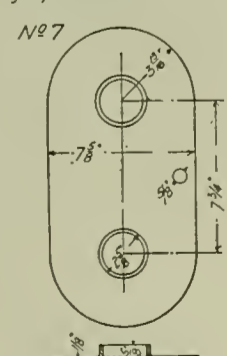

Same as No. 6 but with groups of two coils with inner coils.

Graduated springs, or springs made of other than round bars, have not been considered, and as the elastic limit per square inch is greater for smaller bars than the larger, it is objectionable to use larger sections than are absolutely necessary. Also as spring coils, and not the spring plates, are the expensive articles and those that break, it is not desirable to sacrifice the designs of the springs for the sake of limiting the cost and number of patterns for spring plates, and it is considered preferable to buy the springs by the coil, and the plates separately, not to be put up in sets.

Since it has been found upon investigation that the pressed-steel plates are slightly cheaper than malleable iron, plates of designs suitable for pressed steel only have been submitted. Moreover, the use of both pressed steel and malleable iron plates means two separate sets of springs, as, owing to the difference in thickness of the pressed steel and malleable iron (about 1/4 inch for a pair of plates), the springs used with the steel plates would have to be 1/4 inch higher than those used with the malleable iron, to give the same free heights over spring plates. It has further been decided that the use of bolts for securing the top and bottom plates are not only superfluous, but a source of danger, in that these bolts get in between the coils and springs, and cause the destruction of the springs, and also are a source of expense in the first cost of the spring plates, as the provision for such bolts adds to the cost.

In the designing of the springs themselves, the best practice has been followed in all cases, and spring makers consulted.

Your committee therefore recommends for adoption as standards the following coils, drawings of which are submitted. The combinations in which these coils can be used appear in the schedule.

SCHEDULE

FOR THE USE OF RECOMMENDED STANDARD SPRINGS.

Capacity of Car.	Arch-Bar Trucks — Per Group.				Pedestal Trucks — Per Box			
	No. of Coils.	Capacity, Lbs.	At. Inches	Weight Lbs.	No. of Coils.	Capacity, Lbs.	At. Inches	Weight Lbs.
40,000 Lbs.	4 of A	14,000	5 1/2	43	No. 1	.....	.....	.....
50,000 Lbs.	4 of A 2 of B	16,300	5 1/2	51	No. 1	1 of C	8,000	6 24 1/2
	5 of A	17,500	5 1/2	53 1/2	No. 2	.....	.....	.....
60,000 Lbs.	4 of A 4 of B	18,600	5 1/2	59	No. 1	1 of C 1 of D	12,500	6 34
	6 of A	21,000	5 1/2	64 1/2	No. 3	.....	.....	.....
70,000 Lbs.	2 of C 2 of D	25,000	6 1/2	68	No. 4 or No. 5	1 of E 1 of F	16,000	6 1/2 44 1/2
	2 of E 2 of F	32,000	6 1/2	89	No. 6 or No. 7	1 of E 1 of F	17,000	6 1/2 44 1/2

NOTE — Heights given in above include spring caps for arch-bar trucks.  
Number and class letter of springs used to be stenciled on the trucks of cars.

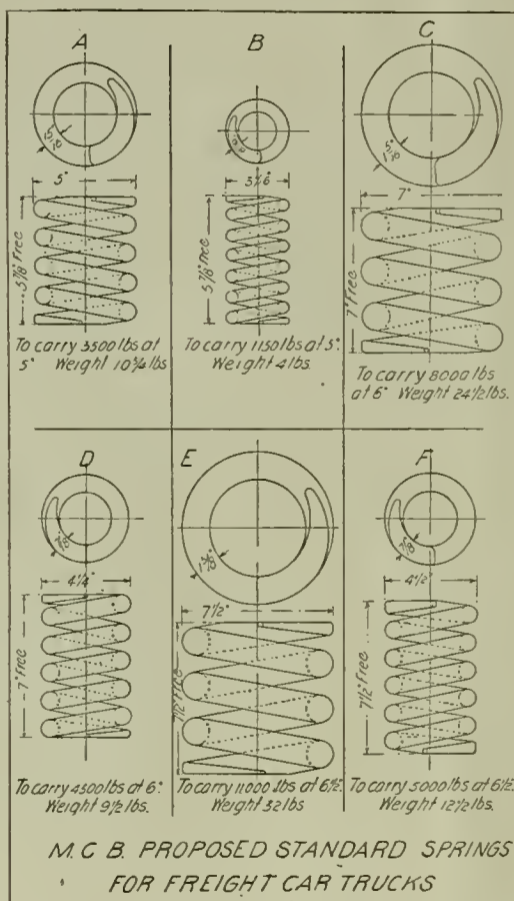

Spring A.—5 inches diameter, 5-16 inch diameter steel, 5 1/2 inches free high; to carry 3500 pounds at 5 inches; weight, 10 1/4 pounds.

Spring B.—3-1-16 inches diameter, 9-16 inch diameter steel, 5 1/2 inches free high; to carry 1150 pounds at 5 inches; weight, 4 pounds.

Spring C.—7 inches diameter, 15-16 inch diameter steel, 7 inches free high; to carry 8000 pounds at 6 inches; weight, 24 1/2 pounds.

Spring D.—4 1/4 inches diameter, 7/8 inch diameter steel, 7 inches free high; to carry 4500 pounds at 6 inches; weight 9 1/2 pounds.

Spring E.—7 1/2 inches diameter, 1 3/8 inch diameter steel, 7 1/2 inches free high; to carry 11,000 pounds at 6 1/2 inches; weight, 32 pounds.

Spring F.—4 1/2 inches diameter, 7/8 inch diameter

steel, 7 1/2 inches free high; to carry 5000 pounds at 6 1/2 inches; weight, 12 1/2 pounds.

By reference to the column headed 'Arch Bar Trucks' in the schedule submitted, it will be seen that the carrying capacities of the groups recommended increase by fairly regular gradations. To enable the recommended standard coils to be most generally and economically useful, such groups can be selected and used as come nearest in capacity to the actual load to be carried, without reference to the marked carrying capacity of the car. Thus a heavy refrigerator car of 50,000 pounds capacity and a flat car of 70,000 pounds capacity may use the same combination of springs, on account of the great difference in light weight of the bodies.

If this plan is followed the committee would recommend that the number and class letter of the coils to be used in each truck should be stenciled on the truck to prevent mistakes being made by repairmen.

To meet the greatest possible variety of conditions, drawings for spring caps are submitted, showing caps for springs C and D or E and F, to be used in groups of four, or in groups of two, the smaller coils being placed inside the larger ones. Your committee recommends that the springs and caps submitted, and the schedule for their use, be adopted.

JOHN S. LENTZ,  
A. G. STEINBRENNER,  
R. P. C. SANDERSON,  
F. W. BRAZIER,  
Committee.

RUST FROM SALT-WATER DRIPPINGS.

The origin of the inquiry as to the damage resulting from salt-water drippings is clearly set forth in some remarks that were made by the chairman of the present committee during the Master Car Builders' convention of 1897.

Ever since this subject was first brought to public attention, in 1896, there has been an effort on the part of the owners of the refrigerator cars in which dressed beef is handled to create the impression that salt-water drippings were not doing any particular harm, and might be neglected. The fact that the Master Car Builders' Association has thought it necessary to appoint a committee to prepare a report on this subject is sufficient answer to the claims of the owners of refrigerator cars that the salt-water drippings are not harmful.

The information received by the committee indicates that more interest is being taken in the subject by the

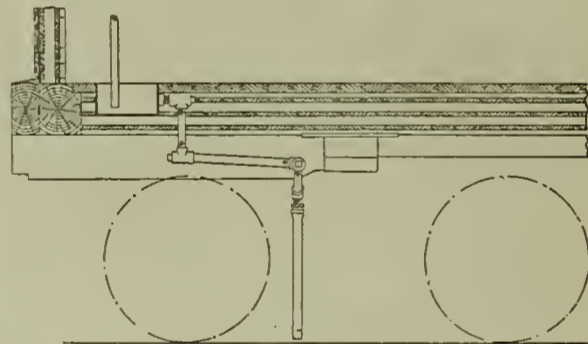

DEVICE NO. 1 FOR DISPOSING OF SALT WATER DRIPPINGS.

officials in charge of the track and bridges than by those in charge of the rolling stock, which is accounted for by the fact that the track and the bridges are being more damaged by salt-water drippings than the car trucks.

It should be understood that the salt-water drippings come from refrigerator cars loaded with dressed beef. In such cars the mixture used for cooling purposes is composed of ice and salt, the proportion of the salt to the ice varying from 6 per cent to 11 per cent, and one refrigerator car will produce about 200 gallons of salt water or brine every twenty-four hours, which on an average will contain 8 1/2 per cent of salt.

At one icing station where 5200 cars were taken

care of, that number of cars was supplied with 6,072,000 pounds of ice, and 503,000 pounds of salt.

Replies to the circular of inquiry sent out on November 22, 1897, have been received from railroads that

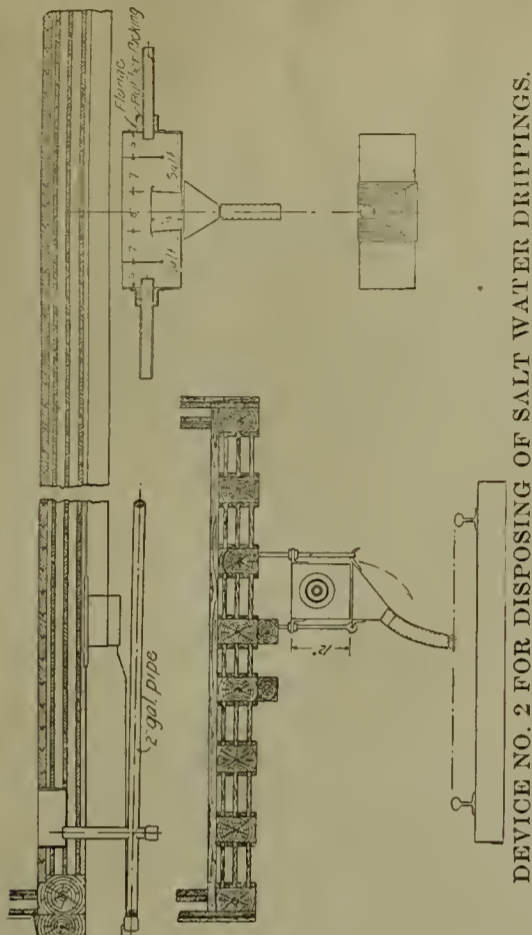

handle about 55,000 refrigerator cars loaded with dressed beef per year

The committee started out with the idea of having refrigerator cars fitted with one or more reservoirs, to be attached underneath the car body, into which the salt water drippings could be conveyed, the reservoirs to be large enough so that they would not have to be emptied more than once every twelve hours, at division terminals, where proper provision could be made for taking care of the salt water. This idea, however, met with so much opposition on the part of the refrigerator car owners, that the committee abandoned it, not caring to recommend an arrangement that the refrigerator car owners would be unwilling to adopt.

The committee presents two methods that can be followed without much expense, either one of which will improve the present condition of affairs; and although a patent has been applied for in the case of Design No. 2, it is the opinion of the committee that Design No. 2 will give the better results. Design No. 2 will be the more expensive, but it will not cost to exceed \$5 per car, including a royalty, if the patent is granted. The principle of both designs is to convey the salt water so that it will drop between the rails, at about the center of the track, where it will do little or no damage.

In fitting up a refrigerator car with either type of attachment, care should be taken to provide caps or plugs at proper points, so that the pipes can be readily cleaned out, and galvanized iron piping should be used, in order to resist the corroding action of the salt water or brine in passing through it.

S. HIGGINS,  
A. M. WAITT,  
Committee.

STEEL CAR FRAMING.

The Committee on Steel Car Framing, appointed at your 1897 convention to review plans submitted by members of a similar committee in 1897, and to report upon designs for cars of different classes, has endeavored to collect the necessary information to carry out its instructions, but it has succeeded in obtaining dimensions of only one of the frames submitted in 1897 sufficiently in detail to admit of exact and complete calculations of strength. Your committee has obtained blue prints of steel car frames of several designs which were not described in the report submitted last year, but all but two of these designs lack so many dimensions that calculations of their strength could not be made, and, furthermore, attempts made by the committee to obtain further information were unsuccessful.

But twelve members of the association replied to the circular which the committee issued to elicit information. The questions contained in the circular will be given later, as well as all answers to them which were received. The members who replied to the circular represent 151,828 cars, or about 12.4 per cent of the total number of cars represented by the association. The number of cars represented by those who replied to the circular and by the members of the committee is 208,389 or about 17 per cent of the number of cars represented by the association.

The circular of inquiry issued by the committee read as follows:

To the Members of the Master Car Builders' Association:  
Your committee on "Steel Car Framing" would be glad to receive any designs for steel car frames which, in your

judgment, are worthy the consideration of the committee. Will you please furnish the following information:

1. If you have had any steel car frames in use, please describe all the important facts about them which your experience has brought forth, and furnish working drawings illustrating the frame

2. Which do you consider preferable for the members of the car frames, rolled shapes of standard commercial sizes or special pressed shapes?

3. Which do you prefer, a car frame made entirely of steel, or a composite frame made of steel and wood?

4. What parts do you recommend be made of wood?

5. What is your opinion of the advisability of using truss rods under side sills of steel car frames? and give the reasons for your opinion

6. Do you recommend that the draft gear of steel car frames be located between center sills and firmly secured to them, or the use of independent draft timbers below the center sills, similar to the construction which is now generally used on wooden cars?

7. What do you recommend, wooden or steel side and end sills, and what are your reasons therefor?

8. Please give maximum light weight of car, per ton (net 2000 lbs.), you would recommend for each ton of paying freight

9. Recognizing the fact that steel car framing will be used in cars of very large capacities, what type of center plate would you recommend, and what maximum bearing pressure, per square inch, would you recommend for carrying the car and lading?

10. What type of side bearing would you recommend for cars of large capacities with steel car framing?

The replies received were as follows

To question number one: "If you have had any steel car frames in use, please describe all the important facts about them which your experience has brought forth, and furnish working drawings illustrating the same," six individuals and companies reported the results of their experience with steel cars.

To question number two: "Which do you consider preferable for the members of the car frames, rolled shapes of standard commercial sizes or special pressed shapes?" six replied that they preferred rolled shapes; one preferred pressed-steel shapes except for center sills, which he thinks should be "I" beams; and one replied as follows:

"Would prefer pressed shapes for the following reasons:

a. The various members can be made to uniform strength by placing the metal where it will be most useful

b. The parts can be made lighter in weight.

c. Better connections for the various parts can be provided for."

To question number three: "Which do you prefer, a car frame made entirely of steel or a composite frame made of steel and wood?" seven replied that they preferred all steel, two preferred steel and wood, and one preferred steel and malleable iron

To question number four: "What parts do you recommend be made of wood?" one recommended that center sills only be made of steel; another replied that the end sill is the only part which it is allowable to make of wood; another recommended that the floor and the superstructure be made of wood in all cars except coal and flat; another recommended that the floor, sides and ends only be made of wood; another advised as follows: "Would recommend that any parts of car subjected to abrasion or which might be injured by the material to be carried or any covering for the purpose of protecting the load from the action of heat or cold be made of wood. Generally speaking, the covering of superstructure and floors, but not of necessity the framing of superstructure."

To question number five: "What is your opinion of the advisability of using truss rods under side sills of steel car frames? and give the reasons for your opinion," the replies were as follows: Seven recommended that no truss rods be used, one recommended truss rods to support the side sills, and one recommended truss rods if by their use the car can be made lighter

To question number six: "Do you recommend that the draft gear of steel car frames be located between center sills and firmly secured to them, or the use of independent draft timbers below the center sills, similar to the construction which is now generally used on wooden cars?" ten replied that the draft gear should be placed between center sills.

To question number seven: "Which do you recommend, wooden or steel side and end sills, and what are your reasons therefor?" nine replied that they favored the use of steel end sills, and one recommended wooden end sills.

To question number eight: "Please give maximum light weight of car, per ton (net 2,000 lbs.), you would recommend for each ton of paying freight?" 600, 700 and 800 lbs. are recommended. One member suggested 900 lbs. for coal cars only. In another reply 666 lbs. is recommended for hopper cars to carry iron ore, and 800 lbs. for box cars.

To question number nine: "Recognizing the fact that steel car framing will be used in cars of very large capacities, what type of center plate would you recommend, and what maximum bearing pressure, per square inch, would you recommend for carrying the car and lading?" three recommended the use of pressed-steel center plates, and one recommended malleable iron. One member recommended that the bearing pressure shall not exceed 1600 lbs. per sq. in., and another 2500 lbs. per sq. in. One member thought that cars should not be center bearing, but that each of the side bearings should support as much of the load as the center plate

To question number ten: "What type of side bearing would you recommend for cars of large capacities with steel car framing?" six recommended plain side bearings of pressed steel or malleable iron, and two recommended roller side bearings.

Your committee herewith presents designs of cars as described below, which designs are for the most part general and incompletely dimensioned.\*

Penneck Steel Hopper Ore Car.....	80,000 lbs. capacity.
Penneck Steel Flat Car.....	80,000 lbs. capacity.
Penneck Steel Gondola Car.....	80,000 lbs. capacity.
Schoen Steel Double Hopper Gondola Car.....	100,000 lbs. capacity.
Harvey Steel Box Car.....	80,000 lbs. capacity.
Barr's Steel Underframe for Flat Car.....	60,000 lbs. capacity.
Sanderson's Steel Underframe for Box Car.....	60,000 lbs. capacity.
Norfolk & Southern Steel Flat Car....	60,000 lbs. capacity.
Great Northern Ry. Steel Box Car....	60,000 lbs. capacity.
Fox Pressed Steel Equipment Company's Steel Flat Car.....	100,000 lbs. capacity.

\*We have previously published these designs.

Fox Pressed Steel Equipment Company's Gondola Car.....100,000 lbs. capacity.

In conclusion, your committee respectfully asks that the foregoing be accepted as a brief statement of the present status of the subject of steel cars, and as a partial history of the development of such cars up to the present time.

The members of your committee believe that at the present time it is impossible to design a steel car frame which will meet with universal favor. The extremely limited extent of the experience which has been obtained with steel cars up to date is alone a sufficient reason for recommending the postponement of the selection of a design at the present time

Your committee recommends that it be discharged and that the steel car question be considered by another committee of this Association about four years hence

A. E. MITCHELL, Chairman,  
W. P. APPEYARD,  
WM. FORSYTH,  
Committee.

SPECIFICATIONS FOR AIR BRAKE HOSE.

There is a general impression that the strength of an air hose to resist bursting is the one great requisite. It is a fact, however, that almost any hose in the market will withstand an initial bursting pressure many times greater than the maximum strain put upon it in ordinary use. A large number of experiments made by the writer have shown that many of the poorest grades of hose will stand a bursting pressure far in excess of that passed by hose which are known to be of much better quality.

There seems to be a generally accepted opinion, but without any good reason therefor, that it is necessary for an air-brake hose to be made four-ply—that is, composed of four wrappings of heavy cotton canvas—in order to make it of sufficient strength to stand the strains put upon it in service. Tests made, by bursting a large number of hose of various piles and various styles of manufacture, have shown that four-ply air hose are made which will burst at 400 pounds pressure, while other hose made with only two-ply fabric, but manufactured by a different method, cannot be burst at pressures of over 1,200 pounds. The examination of many hundred good quality condemned hose, removed from cars on account of being defective and leaky, has shown conclusively that but very few of them have been removed on account of weakness of the fabric itself. In the construction of an air hose, the canvas or cotton fabric can be considered as the foundation upon which the structure is built. On the fabric alone reliance must be placed for strength to resist the pressures that are put upon it. In general engineering design and construction, it is considered good and safe practice if a factor of safety of five is used. With an air-brake hose on freight cars, 90 pounds is about the maximum pressure that they are called upon to resist. If hose are specified to stand a bursting test of 500 pounds, a factor of safety of a little over 5½ pounds is thereby required, which seemingly should be amply high for all requirements. Nevertheless, specifications that have been submitted to manufacturers are calling for a bursting pressure of 600 and even 900 pounds to the square inch.

The use of inferior materials in hose manufacture, combined with the greatest care in the process of construction, or the use of the best material with carelessness in putting it together, is sure to produce hose which will give unsatisfactory service and short life. With the object of ascertaining what steps have been taken by the railroads represented in this association to insure proper materials and processes of manufacture in the construction of air hose, and also with a view of ascertaining what qualities of air hose are being accepted and used by the railroads, a circular of inquiry was sent out to representative members of our association, asking for copy of specifications under which their hose are purchased, and the qualifications required by tests before acceptance, also a sample of hose purchased was asked for. Very few replies were received—only twenty-two out of the entire number of roads represented. The reason for this may be inferred from the nature of some of the replies, namely, that no attention whatever has been given to the subject by ninety per cent of our companies. That it should have instant and urgent attention is shown by the results developed in tests of twenty-six sample hose received for test. These were of eight different makes, and undoubtedly of greatly varying prices. They range in quality from first-class down to the grade of common cheap garden hose, made largely of reclaimed rubber. Only four of the manufacturers represented had furnished to the railroads hose which, in the matter of good friction and good rubber properly cured, would meet the requirements of the specifications of the Lake Shore, Erie and Baltimore & Ohio railroads. Having referred to the requirements of the specifications of these three roads, it may be of interest to note the detail of such specifications, which are all practically alike in the tests required to show the friction and the qualities of the rubber. As I have not received in reply to circular of inquiry copies of the full present specifications of two of the above mentioned roads, I will give that by which the Lake Shore & Michigan Southern Railway have been purchasing hose for some time, which is as follows:

1st. All air-brake and signal hose must be soft and pliable, and not less than 2-ply nor more than 3-ply. They must be made of rubber and cotton fabric, each the best of its kind made for the purpose. No rubber substitutes, reclaimed or old rubber stock or short fiber cotton to be used.

2d. The tube must be handmade, composed of three calenders of 1-32-inch rubber; it must be free from holes or imperfections in joining, and must be so firmly united to the cotton fabric that it cannot be separated without breaking or splitting the tube. The tube must be made of high quality of rubber, and must be of such composition as to successfully meet the requirements of the stretching test given below. The tube must not be less than 3-32 inch thick at any point. It may preferably be made in composite form, with a complete inner tube of 1-16-inch rubber wrapped with a single wrapping of 8-ounce cotton canvas, the whole being covered with an outer tube of 1-32-inch thick rubber.

3d. The canvas or woven fabric used as wrapping for the hose to be made of long fiber cotton, loosely woven, and to weigh not less than 22 ounces per yard, and to be from 38 to 40 inches wide, except when woven with a seamless tubing. The drapping must be frictioned on both sides, and must have in addition a distinct coating or layer of gum between each ply wrapping not less than 1-32 inch thick. The friction and coating must be of the same quality of gum as the tube. The canvas wrapping to be applied on the bias.

4th. The cover must be of the same quality of gum as the tube, and must not be less than 1-16 inch thick. The cover may preferably be made in composite form in the same manner as provided for with the tube. In this case there must be not less than 1-32 inch thickness of rubber between the outer ply of wrapping and the 8-ounce duck forming part of the cover, and there must be an equal thickness of rubber on the outside.

5th. Air-brake and signal hose are to be furnished in 22-inch lengths. Variations exceeding 1/4 inch in the length will not be permitted. The inside diameter of all such hose to be not less than 1 1/4 inches nor more than 1 5/16 inches, except on the ends, which are to be enlarged to 1 7/16 inches for a distance of 2 3/4 inches, the change from larger to smaller diameter to be made tapering, so that inside of hose will be perfectly smooth. The outside diameter must not exceed 2 inches, nor be less than 1 7/8 inches in the main part, or exceed 2 3/16 inches, or be less than 2 1/16 inches at the enlarged ends. Hose must be finished smooth and be regular in size throughout, as above indicated; ends of hose to be capped with from 1-16 to 1/8 inch of rubber. Caps must be vulcanized on, not pasted or cemented.

6th. Each standard length of hose must be branded with the name of manufacturer, year and month when made, and the standard, L. S. & M. S. R'y mark, thus:



and also have a table of raised letters at least 3-16 inch high, to show date of application and removal, thus:

97		1	2	3	4	5	6
98	A	7	8	9	10	11	12
99							
00	R	1	2	3	4	5	6
01		7	8	9	10	11	12

All markings except the road mark may be combined in one plate.

All markings to be full and distinct, and made on a thin layer of white or red rubber, vulcanized on, and so applied as to be removable only by cutting with a knife or sharp instrument.

7th. Air-brake and signal hose will be subjected to the following tests:

Each hose must stand a proof pressure test of 300 pounds without failure of any kind. With every lot of 200 or less shipped to one point, the manufacturer must furnish free of charge one additional hose for test. From each such lot one hose will be taken at random, and subjected to the following tests in the order named:

Small strips taken from the cover or friction will be subject to the same test.

8th. If test hose fails to stand the required tests, the lot from which they are taken will be rejected without further examination. If test hose are satisfactory, the entire lot will be examined, and those complying with the requirements herein set forth will be accepted. All rejected hose will be returned, the shipper paying freight charges both ways.

When any shipment of hose, made subject to these specifications, is received, one sample is taken at random from different parts of the shipment for every two hundred hose furnished. The sample hose are first subjected to a bursting pressure. In making bursting test, a hydraulic hand pump capable of attaining a pressure of fifteen hundred pounds is used. The test hose has fittings applied in the usual way, and is screwed on to the connection from testing machine; an ordinary Westinghouse coupling closed at the nipple end, but having a small pet cock inserted, is coupled to the test hose. The pet cock is opened and the free end of the hose slightly elevated, while the hose is being pumped full of water, so that the air is allowed to escape. The pet cock is then closed, and the pressure increased till the hose bursts, when the reading of pressure gauge is taken. If the hose successfully resists a pressure of five hundred pounds, a section one inch long is cut from some part not near the rupture, and by means of a knife the outer cover is cut through to the first wrapping of duck or woven fabric, and with the aid of a pair of pliers this outer course is separated from the balance for about one inch. A convenient clamp is next attached to the free end, and the section is slipped as far as possible onto a slightly tapered wood or metal spindle, which has an outer diameter about the same as inside diameter of hose. This spindle is placed in its position in a friction-testing machine, which is shown in Fig. 1, and a twenty-five-pound weight is suspended from the separated end by means of the clamp. The distance that the hose unwraps in ten minutes determines if the friction meets the requirements. As lack of care in the process of manufacture, or the peculiarities of construction of the hose may make the unwrapping take place more rapidly between the first and second courses than between the cover and the first course, it is desirable to first take record of distance unwrapped and the time on the first course, and then a second test in similar manner on the friction of the inner course.

After the one-inch section is unwrapped to the tube, if made in the best manner, it should be found very difficult to separate the rubber of the inner tube from the canvas wrapping. A little experience, however, aided by a few drops at a time of naphtha, will enable the separation of rubber tube, rubber cover, and even the friction-skimming coat, all of which are then tested in the stretching testing machine shown in Fig. 2. The method of testing the strips of rubber is clearly detailed in the specifications. If the test hose successfully passes the friction and stretching tests, all of the hose in the shipment are examined to note their compliance with the balance of the requirements.

The two testing machines illustrated are subject to slight variations in construction, but have proven amply accurate and convenient for the work.

The scrap pile is always a good and fruitful field for observation as to causes of weakness or removal of defective parts of equipment. From the hose scrap pile we find prominent among the causes of disability among hose:

1st. Kinked, with rubber of cover badly cracked at kink, exposing canvas to the weather and causing leakage. In

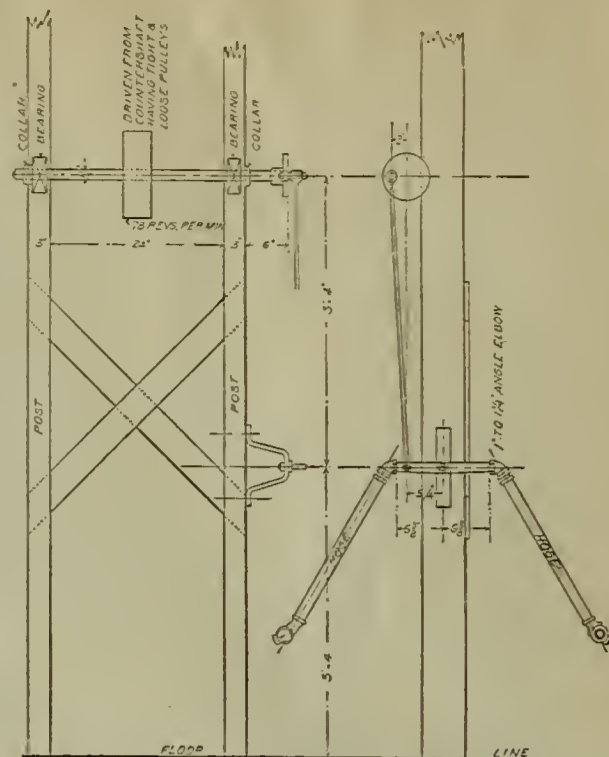

FIG. 3—MACHINE FOR TESTING RUBBER HOSE BY KINKING.

lessly, or by cutting of tube by roughness of the fittings. Sometimes the hose seems porous all over. In every case of a porous or leaky hose, the tube is cut or cracked from this or some other reason. In some cases I have found the tube made of rubber that seemed to have lost its life, and was brittle and full of cracks; in others, especially those having machine-made tubes, or one calender handmade tube, there have seemed to be one or more small holes through the tube, where, either from grains of dirt or grit dropping out, or some other cause, the tube was punctured from the inside.

3d. Chafed or cut by chafing. This is a quite common cause of hose removal. It comes from being hit or rubbed, generally at the nipple-fitting end, thereby bruising or cutting the cover, sometimes into the first or second ply of canvas. This is, as a rule, a defect of less danger than has commonly been supposed, unless the cutting or bruising has cut the tube of the hose, and many hose removed for this defect will withstand a bursting pressure of several hundred pounds.

In order to avoid and prevent these and kindred defects from occurring in hose, as long as possible, certain qualities must exist in the hose when new. Hose must be soft and pliable in order to avoid kinking. It has for some unknown reason been the common practice in air-hose specifications and purchase, to call for nothing but four-ply wrapped hose. In some cases the weight of canvas is specified. Four-ply wrapped hose may be made so that it is reasonably pliable, but it is not an ideal form of construction for readily conforming itself to the swinging and bending it is subjected to in service.

The construction of ordinary wrapped hose is such that the rubber courses and the canvas wrappings do not work

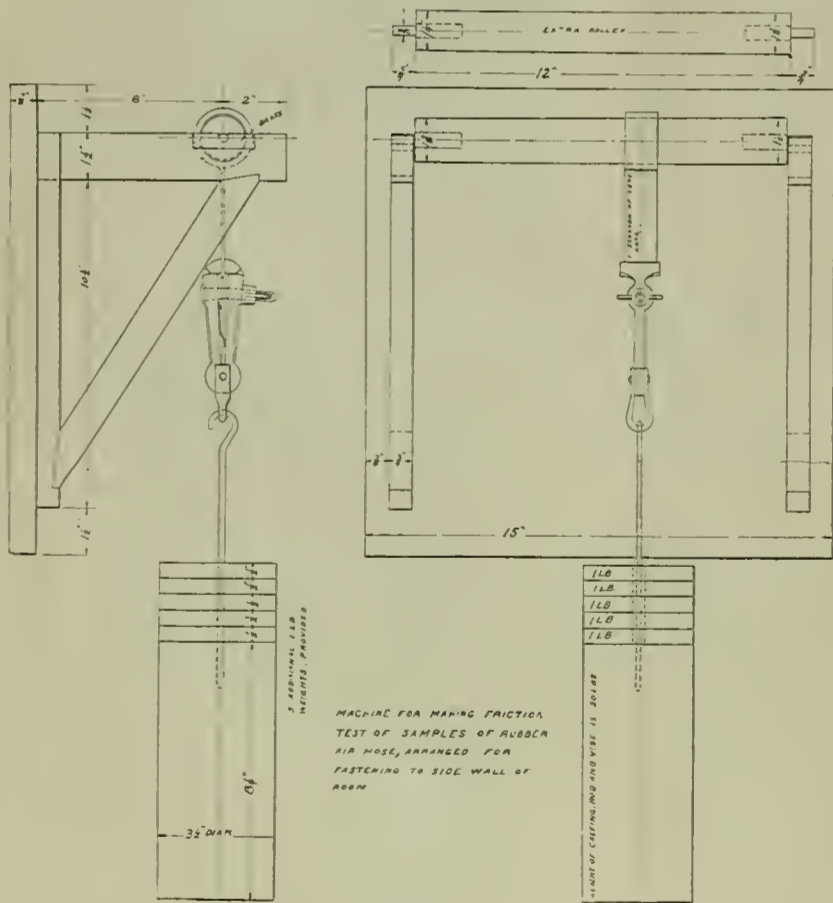

FIG. 1.

BURSTING TEST.

The test hose must stand a pressure of 300 pounds before bursting.

FRICTION TEST.

A section one inch long will be taken from any part of the hose, and the friction determined by the force, and time required to unwind the hose; the force being applied at right angles to the line of separation. With a weight of 25 pounds suspended from the separated end the separation must be uniform and regular, and when unwinding the average speed must not exceed 6 inches in 10 minutes.

STRETCHING TEST.

A 1-inch section of the rubber tube or inner lining will be cut at the lap or thickest part. Marks 2 inches apart will be placed on it. The 1-inch strip will next be stretched until the marks are 10 inches apart, and then released immediately. The piece will then be remarked as at first, and stretched to 10 inches, or 400 per cent, and will remain stretched 10 minutes. It will then be released and the distance between the marks measured 10 minutes after the release. In no case must the test-piece break from defective quality of rubber, or show a permanent set of more than 1/4 inch between the 2-inch marks.

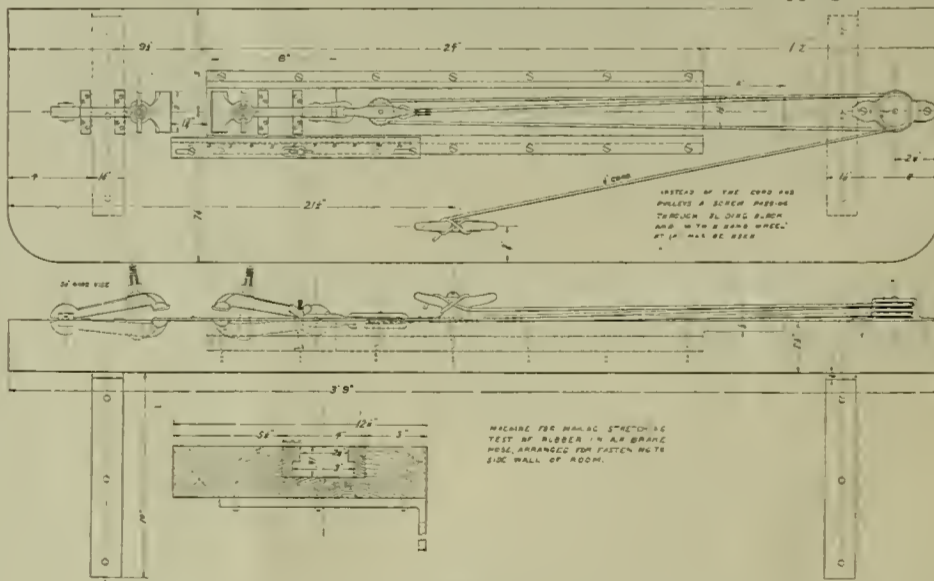

FIG. 2.

these hose it will often be found by opening up the hose that the rubber in the tube is cracked near the kink, and there is nothing to prevent moisture inside the hose from working into the canvas and following it round and round till it reaches the outside of hose. Where the moisture goes the air can follow, hence from this cause we may have many leaky and burst hose. Whenever the protection of the inner tube is lost or interfered with by its being cracked or punctured, the near condemnation of the common form of four-ply wrapped hose is at hand, for the moisture and air pressure will soon work its way out. There is far less danger from the cracking of the cover, as there is no air pressure to help force the moisture inward. Another effect of kinking is to cause a separation between the different layers of the hose, and also to break the fiber of the cotton in the canvas and weaken it at that point.

2d. Porous or leaky around the ends of the hose near fittings. An examination of the interior of such hose after the fittings have been carefully removed will show in a large number of cases that the rubber tube has been slightly torn or cut, either wholly or nearly through the canvas, caused by bruising of tube in forcing the fittings on care-

fully shown when such a hose is put on a kinking machine, such as is illustrated in Fig. 3. After the machine is put in motion, and the hose has been subjected to a slight bending motion at a point near the inside end of the upper fitting, it will be found that at the point bent it becomes so heated in a few minutes that one cannot bear the hand on it. This shows that there is a condition in the structure which is not in harmony when subjected to bending. The rubber readily stretches and accommodates itself to the bent shape while the canvas is stiff and unyielding. This bending under such circumstances causes a change in the original relations of rubber and canvas, and a tendency to pull the rubber from the canvas, which in time cracks the rubber and separates it completely from the canvas.

There are forms of construction of hose in which the canvas and the rubber accommodate themselves with equal facility to the bending, as is shown by the fact that with such hose on the kinking machine there is no perceptible heating at the point of bend, and consequently no tendency to change the normal relation between the fabric and the rubber.

The form of construction last referred to is the tubular.



Long-continued tests on the kinking machine have shown that the tubular form of hose will outlast from three to four of the best make of three or four ply wrapped hose, before showing a leak. Experience with such tests has failed to develop over thirty-three thousand revolutions of the machine with four-ply hose before hose would commence to leak at the bend, while with the two-ply tubular hose it required a little over one million revolutions to cause a leak. Thus it seems to be quite clearly demonstrated that the tubular form of construction of hose seems to be the best adapted for softness and flexibility, and freedom from liability to kink and crack, or leak as a result of kinking.

Further tests of wrapped and tubular hose show that the best makes of four-ply wrapped hose will not show an average bursting pressure much over eight hundred pounds, while with the two-ply tubular they average over one thousand pounds. This strength as well as flexibility seem to be combined in the tubular form.

It has been stated that the tubular hose will expand and distort too much under pressure. Under a pressure of seventy pounds there was no perceptible difference shown as a result of many comparative tests; at a pressure of one hundred pounds in the four-ply wrapped they generally expand one-eighth inch in diameter, while the two-ply tubular expand three-sixteenths inch. In this feature the tubular construction as now made is subject to improvement, either by being made of three woven tubes, or with the double tubes more closely woven so as to prevent quite as much distortion.

Excessive expansion is objectionable. The hose is, during much of its service, under from seventy to ninety pounds pressure; if it expands, of course the rubber in it is stretched from its normal condition. It is a well-known fact that a piece of rubber hose will lose its elasticity and life much more quickly when held stretched than when free, and as a result of excessive expansion in the hose the rubber will soon lose its elasticity and will crack much sooner, thus shortening its life. In my opinion it is not good practice to allow air hose to be made in such a manner that they will expand over one-eighth inch under a

readily without breaking or splitting the tube. The tube must be of rubber, of such composition and so cured as to successfully meet the requirements of the stretching test given below. The tube must not be less than 3-32 inch thick at any point. It may preferably be made in composite form, with a complete inner tube of 1-16-inch rubber wrapped with a single wrapping of 8-ounce cotton canvas, the whole being covered with an outer tube of 1-22-inch thick rubber.

3. The canvas or woven fabric used as wrapping for the hose to be made of good quality cotton, loosely woven, and to weigh not less than 22 ounces per yard, and to be from 38 to 40 inches wide, except when woven with a seamless tubing. The wrapping must be frictioned on both sides, and must have in addition a distinct skimming coat or layer of gum between each ply wrapping not less than 1-32-inch thick. The friction and coating must be of the same quality of gum as the tube. The canvas wrapping to be cut and applied on the bias.

4. The cover must be of the same quality of gum as the tube, and must not be less than 1-16-inch thick. The cover may preferably be made in composite form in the same manner as provided for with the tube. In this case there must be not less than 1-32-inch thickness of rubber between the outer ply of wrapping and the 8-ounce duck forming part of the cover, and there must be an equal thickness of rubber on the outside.

5. Air-brake and signal hose are to be furnished in 22-inch lengths. Variations exceeding 1/4-inch above or below this length will not be accepted. The inside diameter of all such hose to be not less than 1 1/4 inches, nor more than 1 5/16 inches, except on the ends, which are to be enlarged

the hose, and the friction determined by the force and time required to unwind the hose, the force being applied radially. With a weight of 25 pounds suspended from the separated end, the separation must be uniform and regular, and when unwinding the average speed must not exceed 6 inches in 10 minutes.

STRETCHING TEST

A 1-inch section of the rubber tube or inner lining will be cut at the lap or thickest part. Marks 2 inches apart will be placed on it. The 1-inch strip will next be stretched until the marks are 10 inches apart, and then released immediately. The piece will then be remarked as at first, and stretched to 10 inches, or 400 per cent, and will remain stretched 10 minutes. It will then be released, and the distance between the marks measured 10 minutes after the release. In no case must the test piece break from defective quality of rubber, or show a permanent set of more than 1/4 inch between the 2-inch marks.

Small strips taken from the cover and friction will be subject to the same test.

8. If test hose fails to stand the required tests, the lot from which they are taken will be rejected without further examination. If test hose are satisfactory, the entire lot will be examined and those complying with the requirements herein set forth will be accepted.

It would seem reasonable that the developments in the manufacture and use of air hose in the next two years will warrant a further consideration of the subject at that time, and it is not unlikely that the superiority of either the tubular or wrapped form of hose will be so clearly demonstrated as to warrant a much more restricted specification; but if hose in the meantime are brought up to the stan-

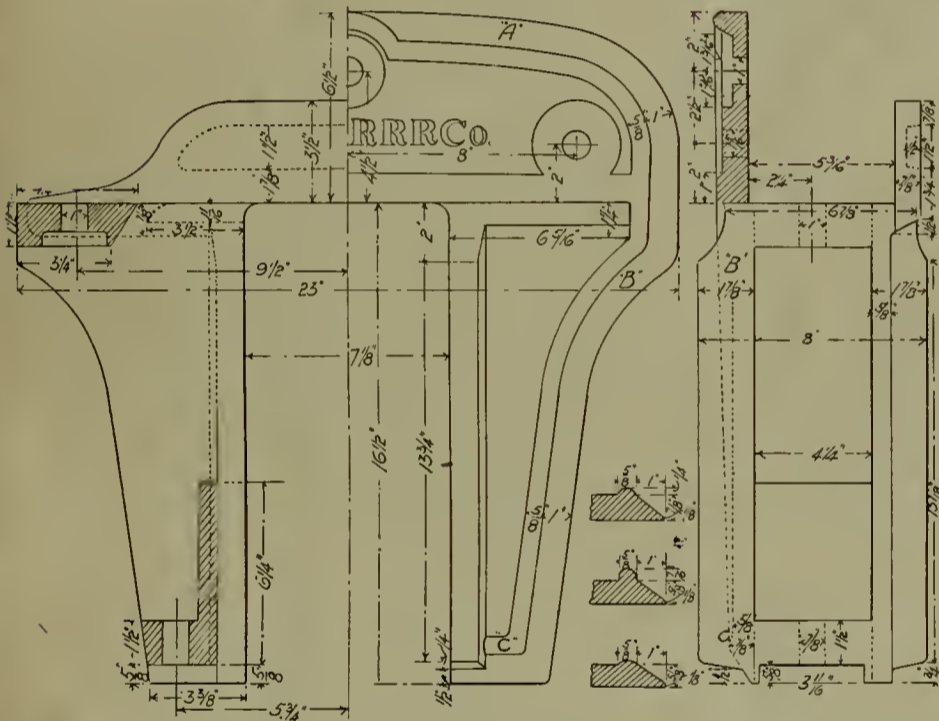

FIG. 2.—PASSENGER CAR PEDESTAL.

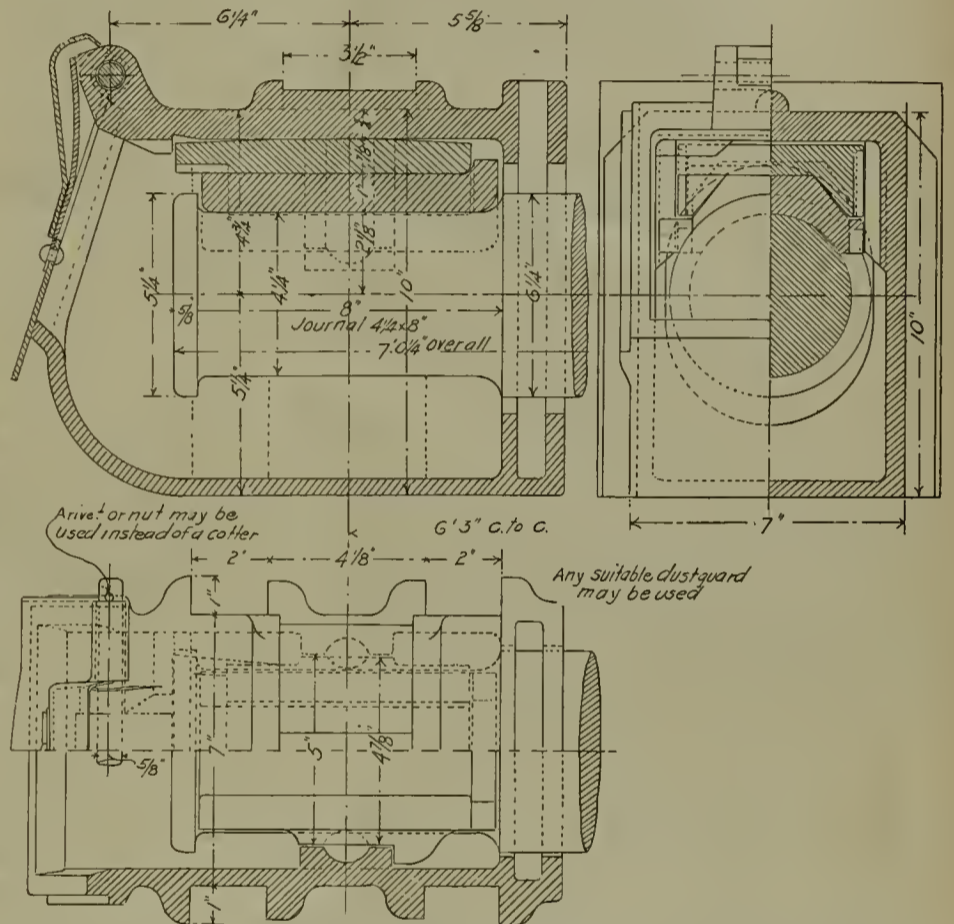

FIG. 3.—JOURNAL BOX AND MAIN PARTS FOR 4 1/4 X 8 IN. JOURNAL.

pressure of one hundred pounds. The objection to excessive expansion, on account of its causing the rubber to crack more quickly, is a reasonable and strong argument for having hose made with enlarged ends. The ordinary 1 1/4-inch hose is 7-32 inch less in inside diameter than the small end of the Westinghouse fittings, and 3/8 inch less than the enlarged part of the fitting. It surely is not good practice to put rubber into the hose and then require it to be permanently stretched 3/8 inch in diameter in order to force the fittings on, when with a little more work by the manufacturer the hose can have slightly enlarged ends which will take the fittings quite readily, and without stretching and straining the rubber and canvas, and thereby surely shortening its ultimate life. Another reason for enlarged ends is the fact that the air-brake fittings are unfinished malleable castings, which oftentimes have small rough or sharp projections on them, which are very liable to cut or tear the inner tube of the hose. With the ordinary wrapped hose, as soon as the tube of the hose is cut or punctured, there is a direct communication, by means of the canvas wrapping, for conducting moisture first and afterward air to the outer covering of the hose. It is the slight tearing or puncturing of the tube on new hose of the ordinary form which causes many of them to be short-lived. On some roads the fault has been entirely attributed to the use of a pneumatic tool for forcing the fittings into place. If the ends of hose had been enlarged, even with the pneumatic tool, no harm would have ensued.

In concluding this paper, it will be desirable to summarize the deductions from the discussion of the various points, by outlining a short draft of a specification which will at least insure by its use the obtaining of reliable hose, well made, and of a higher grade than the average now manufactured, and which will undoubtedly give longer service than a large percentage of the hose used in the past.

RECOMMENDED SPECIFICATIONS FOR AIR-BRAKE AND SIGNAL HOSE.

1. All air-brake and signal hose must be soft and pliable, not less than two-ply nor more than four-ply.
2. The tube must be handmade, composed of not less than two calenders of thin rubber; it must be free from holes, or imperfections in joining, and must be so firmly united to the cotton fabric that it cannot be separated

to 1 7-16 inches for a distance of 2 3/4 inches, the change from larger to smaller diameter to be made tapering, so that inside of hose will be practically smooth. The outside diameter must not exceed 2 inches, nor be less than 1 7/8 inches in the main part, or exceed 2 3-16 inches, or be less than 2 1-16 inches at the enlarged ends. Hose must be finished smooth and be regular in size throughout, as above indicated; ends of hose to be capped with from 1-16 to 1/8 inch of rubber. Caps must be vulcanized on, not pasted or cemented.

6. Each standard length of hose must be branded with the name of the manufacturer, year and month when made, and the standard railroad mark, and also have a table of raised letters at least 3-16-inch high, to show date of application and removal, thus:

98	A	1	2	3	4	5	6
99		7	8	9	10	11	12
00							
01	R	1	2	3	4	5	6
02		7	8	9	10	11	12

All markings except the road mark may be combined in one plate.

All markings to be full and distinct, and made of a thin layer of white or red rubber vulcanized on, and so applied as to be removable only by cutting with a knife or sharp instrument.

7. Air-brake and signal hose will be subjected to the following tests:

Each hose must stand a proof pressure test of 300 pounds without failure of any kind. With every lot of two hundred or less shipped to one point, the manufacturer must furnish free of charge one additional hose for test. From each such lot one hose will be taken at random, and subjected to the following tests in the order named:

BURSTING TEST.

The test hose must stand a hydraulic pressure of 500 pounds before bursting, and must not expand more than 3/8 inch in diameter under a pressure of 100 pounds.

FRICITION TEST.

A section one inch long will be taken from any part of

standard just outlined, a marked upward step will have been taken in this important detail of car construction. Respectfully submitted, A. M. WAITT.

PASSENGER CAR PEDESTAL AND JOURNAL BOX FOR JOURNAL 4 1/4 BY 8 INCHES.

Your committee on passenger car pedestal and journal box for journals 4 1/4 by 8 inches, appointed to report to the convention held in June, 1897, submitted a report at that time, but certain objections were raised to the inside dimensions of the journal box as recommended. The report was referred to the committee on standards of the association, which submitted the following, through Mr. Soule, chairman of the committee:

"The committee on standards, to which was referred the recommendations embodied in the report of the committee on passenger car pedestal, for axle with journals 4 1/4 by 8 inches, begs leave to report that in its judgment the committee on pedestals ought to be continued, and to be merged into a committee, which, it is assumed, will be appointed on the recommendation already made by the committee on standards, to adopt the present standard journal box for use in trucks (whether passenger or freight) having pedestals; the committee so continued to be designated, however, as the committee on passenger truck pedestal, for axle with journal 4 1/4 by 8 inches, and on journal box for use in trucks (whether passenger or freight) involving the use of the pedestal and axle with journal 4 1/4 by 8 inches."

The committee respectfully reports as follows: Owing to the wide variation existing between the

ordinary Master Car Builders' pedestals now used in passenger equipment trucks and the various pedestals now used in freight trucks. The committee is of the opinion that it is absolutely impracticable to follow the recommendations of the committee on standards. To meet all objections raised to the wording of the committee's recommendations in last year's report, it respectfully offers the following for consideration; being governed in a great measure by the replies received, the committee has no hesitation in recommending—

1. The adoption of a standard passenger car pedestal for 4 1/4 by 8 inch journals as shown in Fig. 2, which is the same as Fig. 2 with last year's report. This pedestal has the same width and length of jaw inside as the present M. C. B. standard pedestal for 3 3/4 by 7 inch journal box shown on M. C. B. sheet 10,

chine especially designed for the purpose. In designing the machine two features were kept prominently in view: viz., to make the machine rigid and to clamp the specimen so tightly that no motion would take place in the fixed end, and at the same time to strain it by tension in imitation of the stress produced by the steam pressure.

Although the machine is arranged to test pieces 3, 6 and 9 in. in length, the tests were all made with a uniform length of 6 in., measured from the center of the bolt to the face of the hardened steel die. The liner used in the machine for all specimens was 1-16 in. thick, making the free end of the stay-bolt describe a circle 1/2 in. in diameter. The spring pressure used in all cases was 2,400 lbs., corresponding to the strain exerted by the steam pressure in a boiler where the stay-bolts are spaced 4 in. center to center, with a steam

13-16	5185	4,630
3/4	4418	5,430
11-16	3712	6,465
5/8	3068	7,820
9-16	2485	9,658
1/2	1963	12,226

After experimenting with the 7/8-in. bolt reduced to the different diameters, it seemed plausible that by increasing the diameter to 1 in., and then reducing the section, that a marked improvement might be made. This, however, did not seem to prolong the life to any great extent.

Inasmuch as the cost of labor alone for renewals is nearly three times the cost of the highest-priced stay-bolt iron, it would be economical to use a special stay-bolt iron possessing the necessary properties to resist repeated bendings.

A careful study of the accompanying table shows that the best results were obtained from an iron having an ultimate strength of 48,000 to 49,500 lbs., with an elongation of 28 to 30 per cent in 8 in.

PERSONAL.

Mr. A. Dallas has been appointed master mechanic of the Des Moines Union and Des Moines, North and Western, vice Mr. W. H. Whittaker, resigned.

Mr. A. M. Pareut has been appointed manager of the Pullman Works of the Pullman Palace Car Company. The authority of Mr. Frederick Wild, assistant manager of the Pullman works, is extended over all departments.

Mr. W. J. Hemphill has been appointed master mechanic of the St. Louis, Peoria & Northern, vice A. L. Moler, resigned.

We are informed that our item in the June issue, stating that Mr. Carey Turner is assistant master car builder of the Fremont, Elkhorn & Missouri Valley, is incorrect.

Mr. Samuel Symonds, formerly master mechanic of the Fitchburg, has been appointed foreman of engines on the Philadelphia & Reading.

Mr. Eugene I. Sandt, master mechanic of the Philadelphia & Reading shops at Philadelphia, Pa., has resigned and is succeeded by Mr. Harry Delaney.

Mr. L. H. Sherman has resigned as master mechanic of the Inter-oceanic railway of Mexico, at Puebla, Mex.

Mr. H. Roberts, formerly master mechanic of the Grand Trunk at Fort Gratiot, Mich., has been appointed superintendent of motive power of the Norfolk & Southern, vice Mr. G. R. Joughins, resigned.

Mr. Edward L. Coster has been appointed assistant in mechanical engineering at Columbia University. Mr. Coster is well known as a student of railway mechanics, is an associate member of the American Society of Engineers and an honorary member of the Master Mechanics' Association.

Mr. A. P. Massey, mechanical engineer of the New York Air Brake Company, died June 5 at sea. Mr. Massey was a man of remarkable mechanical genius, and possessed an unusually attractive personality.

Mr. Jas. McNaughton, superintendent of motive power of the Wisconsin Central, has resigned to become superintendent of the Brooks Locomotive Works.

The June number of the Journal of the Franklin Institute gives a fine portrait and a biographical sketch of the late Jules Viennot, who was a member of the Institute and who died at his home in Philadelphia on the 11th of last March. Mr. Viennot was well known to those who have charge of the business interests of the leading railway papers of this country, through the fact that he placed the advertising of several of our large railway supply houses. He was greatly respected because of his intelligence and sterling honesty. From the notice above referred to as given in the Journal of the Franklin Institute we extract the following concerning Mr. Viennot's interesting career: "Jules Viennot was born in Paris, in 1825. His father was the owner of 'Le Corsaire,' one of the leading Parisian political journals of the day. From 1847 to 1851, the son served in the French army. He was wounded while attacking the barricades of the revolutionists in 1848. After this, and during the 'Journées de Juin,' he was attached, as instructor, to the Garde Mobile. After leaving the army he was active in commercial life in France and Belgium. In the early sixties he came to America, where he has since resided. He became a member of the Franklin Institute in 1881. In 1897 he was made a director of the Société de Bienfaisance Française, of which he had been a member for several years. In 1894 he received from the French government a decoration in recognition of his hospitable services in behalf of technical and other visitors from France, particularly during the World's Fair in Chicago in 1893, when he devoted himself most unsparingly to the reception and entertainment of a large body of members of the Société des Ingénieurs Civils de France."

The biggest member—physically—of the associations at Saratoga was Mr. Alex. Shields, master mechanic of the Bedford Belt and the Southern Indiana roads, at Bedford, Ind. He is six feet four inches high and

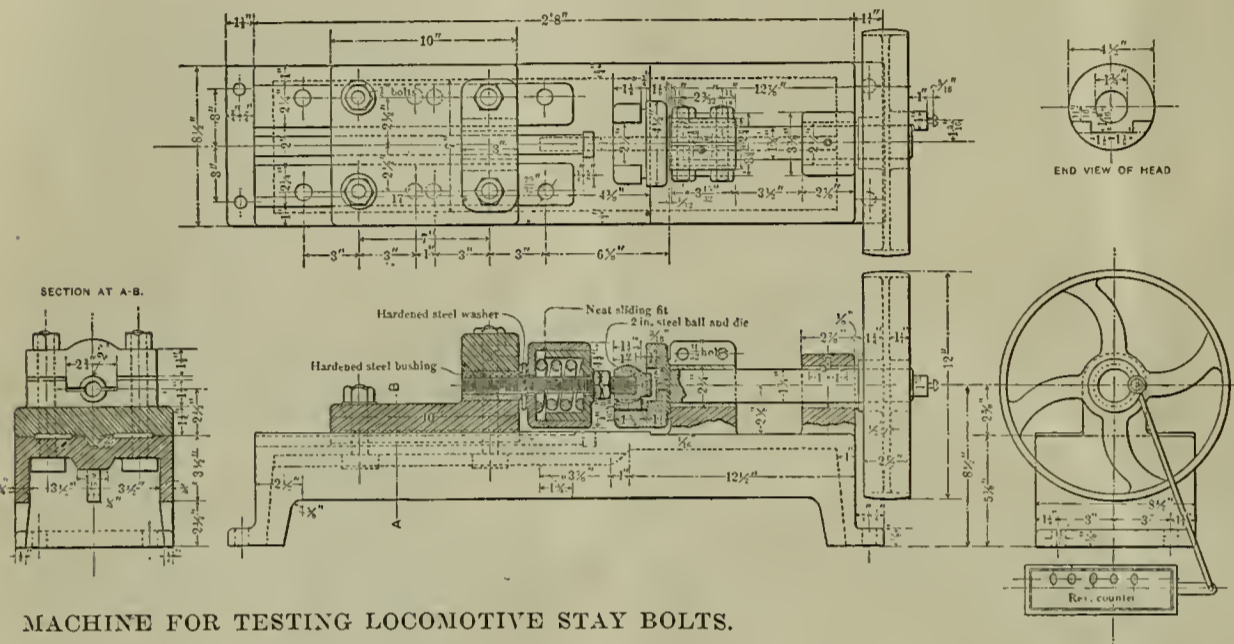

MACHINE FOR TESTING LOCOMOTIVE STAY BOLTS.

but it has a different design of top and a different location of bolt holes therein.

2. The adoption of a passenger car journal box for use with journals 4 1/4 by 8 inches, with inside dimensions as shown in Fig. 3 herewith. These dimensions admit of the standard 4 1/4 by 8 inch journal bearing and key as used in freight journal boxes. This design, with these inside dimensions, has been in successful use for several years.

Geo. W. West,  
T. B. Purves, Jr.,  
J. W. Marden,  
Committee.

BENDING TEST OF LOCOMOTIVE STAY BOLTS\*

BY F. J. COLE.

The stress on a stay-bolt produced directly by the steam pressure, tending to force the two sheets apart, is a comparatively small factor in causing its fracture, the tensile stress alone being only 1/3 to 1-10 of the ultimate strength, which, if not complicated by the expansion and contraction of the fire-box, causing bending in addition would in itself never produce a fracture. It follows, then, that the property of a metal to resist repeated bendings is more valuable than its

pressure of 150 lbs. per sq. in. The imitation of the strains produced in a stay-bolt, when screwed in a boiler, is very close, and while some of the tests of the same bar show a larger percentage of difference than in the tensile tests of the iron, yet this is probably accounted for by the fact that in case the threads were cut sharper, or any flaw existed in the iron, its effect would be very much more marked and exaggerated than would be shown by an ordinary tensile test. While the individual tests of specimens cut from the same bar are somewhat erratic in a few instances, yet the average of the tests cut from the same bar seems to follow some well defined law.

Cutting off the threads and reducing the size of the middle of the specimen does not in these tests indicate a sufficient degree of improvement in prolonging the life of the stay-bolt, to warrant the extra expense. It appears that after a bolt is reduced and turned down a sufficient amount to equalize the strain, and to distribute it over a considerable portion of its free length, the stress produced by the pressure of the spring runs up to such an extent, per sq. in. of section, that the combination of bending and extension stresses, exercises a marked influence in shortening the life of the bolt.

The table given below indicates for a uniform pres-

Specimen No.	Nominal Diameter, Inches.	No. of Pieces Tested.	BENDING TEST.			AVERAGE TENSILE TEST.			
			Maximum No. of Revolutions.	Minimum No. of Revolutions.	Average No. of Revolutions.	Strength per Sq. Inch.	Elastic Limit.	Elongation per cent. in 8 Inches.	
1	3/4	6	2,453	2,154	2,319	51,385	35.50	24.00	Good Wrought Iron 16c per lb.
2	3/4	6	2,785	2,235	2,522	49,565	32.650	23.43	
3	3/4	6	4,453	1,226	2,811	46,535	29.450	20.75	
4	3/4	6	2,028	1,553	1,868	61,595	44.700	18.00	Ordinary Mild Steel, Merchant.
5	3/4	6	1,289	832	1,153	53,013	36,200	25.33	
6	3/4	6	2,147	1,015	1,863	51,340	37,270	24.25	Imported Stay-bolt Iron, 6c per lb.
7	3/4	12	5,914	676	2,185	52,228	53,718	29.25	
8	3/4	8	4,184	2,532	3,217	51,968	34,710	29.37	Special Stay-bolt Iron, 4 3/4c per lb.
9	3/4	15	4,986	2,021	3,235	48,559	32,115	26.81	
10	3/4	11	3,794	2,129	2,753	49,650	28,850	30.94	Swedish Iron, 2 1/4c per lb.
11	3/4	10	4,428	2,081	3,338	43,190	23,950	27.68	
12	3/4	11	4,310	2,095	3,289	45,270	30,995	38.78	Ordinary Stay-bolt Iron, 3c per lb.
13	3/4	14	3,627	1,755	3,036	48,598	31,808	36.03	
14	1	9	3,414	1,894	2,447	48,120	32,900	28.81	Same as 1, 2 and 3, with center reduced to 1 1/16 in diameter.
15	3/4	8	4,319	2,300	3,118	47,066	31,730	28.10	
16	3/4	11	6,700	1,698	4,871	49,550		27.06	
17	3/4	9	9,621	2,841	4,825	48,400		28.12	
18	3/4	9	3,720	1,902	2,637	48,146	31,250	25.50	

strength to resist extension or fracture in the direction of its length. Following out this general idea a number of different makes of iron were tested on a ma-

sure of 2,400 lbs., the stress per sq. in. of section on the different diameters of reduced bolts:

Size, in.	Area.	Stress, Lbs.
1	7854	3,050
1 1/16	6903	3,475
3/4	6013	3,990

\*From a paper read before the American Society of Mechanical Engineers in June, 1898.

weighs 254 pounds. He is a good-sized man intellectually, also—being known to many as a successful emitter of rhymes, as well as a first-class master mechanic. He does not look to be quite as large as he really is, because he carries himself modestly, but he is an athlete and a serious proposition to handle. He is young, and still growing—if not physically yet in other ways. The smallest member—but there were no small members! Some of those who measure and weigh least are really rods high and tons in weight!

### SUPPLY TRADE NOTES.

—Mr. J. W. Gardner, recently connected with the Sterling Boiler Company and for a long time western manager for Manning, Maxwell & Moore, has accepted a position with the sales department of the Sargent Company.

—From July 1 Mr. Richard H. Soule will act as western representative of the Baldwin Locomotive Works at Chicago. Mr. C. A. Thompson of St. Louis will act as southwestern representative. Mr. Rhodes, who has been in charge of the Chicago office, returns to the works at Philadelphia.

—The Moore Manufacturing Company, Cleveland, Ohio, has changed its name to the Chisholm & Moore Manufacturing Company. This company makes an electric chain hoist for which there is a rapidly growing demand.

—The Eyeless Tool Company, New York, recently received, from the government, an order for a car load of picks (3,600) for Tampa, Saturday, at noon, and the loaded car was on its way the same evening. Thirty-five men were employed in loading. This company has since received several important government orders.

### Exhibit at the Conventions.

Compared with previous years the exhibits at the Saratoga conventions were somewhat less in number, but in interest and value they averaged higher than ever before. Nearly all of them had special features of interest, and the members of the associations were able to see and compare practically side by side the rival new or improved devices which they are being urged to adopt. And the railway officials at Saratoga certainly took advantage of their opportunities, with very few exceptions, and gave the exhibits careful and even repeated examinations. Most of those in charge of exhibits at these conventions have learned to restrain their longings for immediate orders or positive promises, and content themselves with getting or improving the foothold of acquaintance and with explaining the peculiar merits of what they have to sell. This attitude puts the railroad man at his ease and, in the end, is good for the exhibitor. Several concerns deserve credit for not making exhibits. Their goods are well known and are standard on many roads; they had nothing specially new or interesting to exhibit; they were well represented by the presence of their officials and traveling men and to have made exhibits of their lines of staple goods could not have been of any benefit to them. They are to be commended for refraining from making mere perfunctory exhibits.

—The exhibits of pneumatic tools were unquestionably the most attractive, and that of the Chicago Pneumatic Tool Co. must be given the first place because of the number and variety of pneumatic tools shown. That it was profitable to the company is shown by the fact that on Monday, June 27th, thirty eight orders for tools were received, each of which referred to the tool ordered as having been shown at Saratoga. This exhibit comprised:

Four sizes of pneumatic hammers;

Two sizes of pneumatic riveters.

Four sizes of pneumatic drills;

One stay-hot biter;

One flue roller, expander and cutter;

One flue welder and reducer;

One car jack;

One drill press with the air motor a part of the frame;

One lathehead with the air motor a part of the frame;

One pneumatic painting machine;

One pneumatic hoist.

Of the drills two were designed for boring wood, and the rapidity with which these drills bored inch and two-inch holes through heavy timbers was remarkable. The quietness with which the hammers and other tools of this company were operated was very noticeable and was much talked about and greatly commended. President Duntley and his associates may rest assured that their forbearance in the matter of noise was universally appreciated. The exhibit of this company included a Boyer speed recorder in operation. An English order for 100 of these machines is now being filled. The Chicago Pneumatic Tool Co. has just shipped 14 Rand air compressors to Germany.

—Two other exhibits of pneumatic tools added to the interest developed in this branch of manufacture. The Standard Pneumatic Tool Co., Marquette Building, Chicago, showed its line of air drills, hammers and boring tools in excellent shape and with a satisfactory degree

of success. In a booth near by the Q & C Co. industriously and sonorously showed what the Ridgely & Johnson pneumatic hammer could do in chipping off long, thick shavings of boiler steel.

—At none of the conventions for many years has there been so few car coupler exhibits. Not a single full-size link and pin coupler was shown. Among the new M. C. B. couplers exhibited were the Solid, made at Detroit, by the Michigan Malleable Iron Co.—a simple and strong device; the Washburn, from Minneapolis, Minn., which is in service on several hundred cars and has a successful look; the D. Altman coupler, hailing from Chattanooga, Tenn., which has the operating lever fastened to the knuckle and thus avoids the use of a lifting chain; the Pettingill & Laub "complete" car coupler, which also dispenses with the chain lift, and which handles by an ingenious combination of levers not only car but steam, air and signal connections; having also a jointed head which enables the coupler head to swing when rounding curves while the stem of the drawbar remains rigid. This exhibit showed, in connection with the coupler, which, with its rigging, was mounted on trucks, an automatic connection for air and steam which is offered to the railroads by the same concern. These inventions came from Denison, Ia., and were exhibited by Henry G. Laub. Other new couplers were the Peeless, of 20 Broad street, New York, which has a lock designed to make accidental unlocking impossible and which has been, for a year or more, attracting much attention from eastern railroad men. This exhibit was noticeable for the manner in which the important features of the coupler were plainly shown. Another new coupler was the Foster, of the Fisher building, Chicago, which has unique and ingenious features.

—The exhibit of the Moran Flexible Steam Joint Co., Louisville, Ky., was arranged to represent the great battleship Kentucky. It made a fine showing of a device which is steadily making its way into general use. It has, practically, the field to itself—a field which is constantly widening.

—The Pearson jack (the Pearson Jack Co., 64 Federal street, Boston) was shown in actual service and a car on a side-track was derailed and put on the rails again a great many times under the observation of knots of railway men. The work was done easily and very quickly, and all that is claimed for this jack as an aid to clearing up derailments and wrecks seemed to be made good. It was certainly well advertised at the convention.

—A new, simple and strong car-door lock was shown by Thos. Tighe, Schenectady, N. Y.

—A nut-lock, the Volute, was one of the new exhibits. It is made by the Volute Nut Lock Co., Fort Wayne, Ind., and is claimed to be entirely effective in both metal and wood construction. It is an inexpensive device and is said to have been adequately tested in service.

—Two exhibits of self-adjusting journal bearings, and the attention which they attracted, indicated that the present standard car journal bearing may not be the last step in the development of this part of running gear. The Smith adjustable journal bearing (120 Broadway, New York) had not been previously shown at the June conventions, and Wm. B. Smith, the inventor, who had charge of the exhibit, had reason to be well satisfied with the attention which the device attracted. The Universal car bearing, manufactured by the Universal Car Bearing Co., Bowling Green, N. Y., was well represented. Many of these bearings are in service, and the company is well satisfied with the record they have made.

—A new exhibit was that of the Homestead Valve Mfg. Co., Homestead, Pa., of straightway, 3-way and 4-way valves. The steady growth from year to year of the business of this company indicates that its valves meet a general want in the field.

—The Elastic Nut Co., foot of Russell avenue, Milwaukee, Wis., had a fine exhibit, and Mr. Paine must have been satisfied with the attention which it attracted. This nut is made of tempered steel, is split in a peculiar way and is 1-128 smaller than the bolt. It has remarkable holding power and is, practically, self-locking.

—Four Schoen 100,000 lbs. steel cars stood on a side-track near the station during both conventions, and many a delegation of railway men came to see them. This company, with its immense plant, is becoming known all over the world and is already one of the three or four most notable manufacturing concerns of the country, and it is only on the threshold of its history.

—A fine line of McViekar oil cups, made by McViekar & Sweet, Denver, Col., was shown by Mr. Sweet, who is still interested in the Sams coupler. This cup is an oil saver and will endure rough usage without getting out of order. We shall not be surprised if Mr. Sweet sells a great many of them.

—A locomotive bell ringer made by Oelsh & Malone,

Albany, N. Y., was one of the exhibits.

—The car seat manufacturers contributed, as usual, to the success of the conventions by providing seats for the leg-weary visitors to the exhibit. All the seats were so delightful that it would be invidious to single out any one of them for special mention. If any manufacturer of railway supplies should be encouraged to make a large display at the June conventions it is the car seat manufacturer. After one has been on his legs for two or three hours there are no bad car seats. Some may have points of superiority over others, but the poorest of them is good. We thank the whole list of car seat exhibitors for many restful minutes, and would publish the names of all of them and the special merits of their seats if it were not for the fact that they do not wish to be advertised.

—The Westinghouse Machine Company deserves great credit for making an exhibit of a Westinghouse gas engine in full operation. The engine is rated at 55 h. p. and its load of 200 incandescent lamps, which all day long made a square of dazzling gold in the shadows of the piazza, were by no means a full load for it. The steadiness and quietness of the engine were noticeable. The name "Westinghouse" is a guaranty and the engine seemed well suited to the name. The company furnishes these engines from 8 h. p. up. One of 1,000 h. p. is just undergoing its final tests at the shops and will in a few days be delivered to a street railroad company which will use natural gas as its motive power. Perhaps the ability which produced this machine may evolve a less powerful one suited to many established conditions in the railway service.

—The methods by which the efficiency of the Westinghouse friction buffer and draft gear were shown amounted to a complete demonstration. This device has occupied much of the thought of one of the foremost inventors of this century, and it now seems to meet successfully all possible conditions of service. Those who witnessed the tests to which this device was subjected learned some new things and will not forget the lessons. The standard draft gear of our modern freight cars has many apologists, but no defenders, and the field for an improvement like the one referred to would seem to be white for the harvest. Surely the time cannot be far distant when the railroads will get tired of repairing draft riggings.

—If every master mechanic at Saratoga was not convinced of the merit and value of the driver brake release valve shown by the M. M. Buck Mfg. Co. it was not the fault of Mr. Wheelhouse. He was "instant in season and out of season," as the scriptures say—by which we mean that he let no good chance go by him.

—Though brake-slack adjuster inventions seem to be taking a s'esta just now, several such devices were shown at the conventions. The Q & C Co. showed the McKee air brake adjuster for passenger cars; the Chicago Railway Equipment Co. had an air brake controller for freight cars in operation; the McBeth adjuster was shown on one of the cars on the side track, and there were also one or two models of similar devices on exhibition.

—The more impracticable the invention of an inventor is the more ready he is to explain it fully to the citizens of Saratoga and to bell boys and waiters of Congress Hall.

—The Hien coupler rigging for locomotive pilots attracted much attention and seems to be a genuine improvement. It is so designed that any M. C. B. coupler can be used with it. It was exhibited by the Railroad Supply Co., of Chicago.

—The Cleveland City Forge & Iron Co. exhibited a truly American, up-to-date and fin de siecle turnbuckle. It was 7 ft. long, its sides were 6½ in. wide, and 10½ inches deep. Such turnbuckles are fitted (and were probably designed) to make the connection between this country and conquered Cuba tight and firm; or they will come into play when the Atlantic is bridged and Uncle Sam and John Bull stroll over the structure with their arms around each other. Meanwhile the company is making common, practical, every-day turnbuckles by scores of thousands.

—An exhibit which is likely to mark the beginning of a great industry in the manufacture of steel car wheels was that of the Facer Forged Steel Car & Locomotive Wheel Co., Independent building, Germantown, Pa. The steel ingot from which the wheel is made was shown; also the rough blank into which the ingot is first forged, and two or three finished wheels. The latter were very handsome wheels and looked as if they would successfully meet the conditions of any service. It is claimed that these wheels can be furnished, with a sufficient margin of profit, at 70 per cent of the price of composite steel wheels, and that, besides, they are safer to run than any built-up wheel can be. The exhibit was well placed and well conducted, and the opinions of railroad men concerning the wheel, which were freely expressed, were universally favorable. The exhibit made a decided impression upon the members of the associations.

—The International Correspondence School, Scranton, Pa., had a most creditable display of its methods at the conventions. This school stands at the head of all such institutions, most of the others being merely feeble imitators of it. This one is genuine and successful.

—The bolt forging machine of the Ajax Mfg. Co., Cleveland, O., slipped from the truck which was taking it to Congress Hall and crashed down upon a stone pavement, without injury to any of its parts. When, at last, it reached its place among the exhibits it was kept in motion with air. It is a sturdy, efficient machine, and a table covered with samples of its work showed what it could do.

—A good exhibit was that of the torsion proof car roof made by F. W. Bird & Son, East Walpole, Mass. A section of a full size roof was shown which made the plan of construction easy to understand.

—The W. H. Coe Mfg. Co., Providence, R. I., made its first exhibit (at steam railroad conventions) of the gilding machines which it manufactures and which are time and money savers.

—The Davis "tight joint" journal box lid was shown by the Davis Pressed Steel Co., Wilmington, Del. This invention appears to be both new and efficient.

—The Diamond Rubler Co., Akron, O., has come into the railway field, under its new management, and the showing which it made at Saratoga was a good one. There was always some one at its space to shake hands and explain, while the young African in oriental costume who distributed souvenir bunches of matches for the company pervaded the grounds untiringly with his inexhaustible basket.

—It was impossible to miss the two-story exhibit of the Standard Coupler Co., Haverlyer building, New York, and no one wanted to miss it. The manner in which the exhibit was arranged equalled all visitors to see the method of applying the Sessions steel platform, which, by reason of its simplicity, strength and cheapness is being generally applied to passenger cars in all parts of the country. The combination of such excellent devices as this platform and the Standard coupler and the gentlemen who, on the second floor, dispensed cigars, lemonade, stories, social courtesies and lucid mechanical explanations, was simply irresistible, and the conventions, including the ladies, gravitated toward this exhibit as iron filings hasten toward the poles of the magnet.

—The number and excellence of the exhibits of metal car trucks indicated the interest which is felt by rail-

road men in these devices and the extent to which they are being specified in orders for up-to-date freight cars. The Fox truck, the pioneer in this field of progress, and the most generally used of all, was shown in handsome aluminum models. The Cloud truck and the Bettendorf bolster were shown in full size and received much attention from railroad men. A board platform, a canvas canopy and two or three chairs for visitors, together with the constant presence of some one interested in the exhibit and competent to explain its peculiar features, aided much in making this exhibit successful and profitable. The full size truck and bolster of the American Steel Foundry Co. were placed in a prominent position in the court and received all the attention that the makers of them could desire. The Schoen trucks and bolster were much noticed, and the Barber metal diamond trucks manufactured by the Standard Car Truck Co., Old Colony building, Chicago, were seldom without two or three interested visitors listening to Mr. Barber as he discoursed concerning the merits of his trucks. The Sterlingworth Company, Easton, Pa., exhibited in model a metal truck with roller bearings on the center plate, and also the Joughins truck in photographs. The Buckeye truck, shown full size by the Ohio Falls Car Co., also attracted the attention of those interested in truck designs.

—The exhibits of brake shoes were more interesting than number us. The American Brake Shoe Company, a newly born corporation, one of whose well-known god-fathers is the Sargent Company, of Chicago, and another the Ramapo Iron Works, Ramapo, N. Y., made a very complete exhibit of the new "Diamond S" brake shoe. Both Diamond S and common shoes were shown with the figures of the wear of each on the same road and train and under precisely the same conditions. The showing in favor of the Diamond S was simply paralyzing. The exhibit also showed the structure of this shoe with its wholly original combination of "expanded" steel metal and soft grey iron. This shoe is really something new, and yet it seems to fulfill the conditions which experience has shown to be essential to a brake shoe which will be sufficiently durable to reduce its cost to a reasonable point, while, at the same time, it will develop sufficient friction to stop fast and heavy trains within reasonable distances and yet not produce an abnormal wear of tire. This shoe is believed to meet all the conditions—those insisted on by the master mechanic and those clamored for by the purchasing agent. The exhibit of it at Saratoga was interesting, effective and in excellent taste. There was no blowing of tin trumpets nor loud claims of universal and infinite superiority. The dates were given, the wornout shoes shown

and the visitor was left in peace to draw his own conclusions.

—The exhibit of the Allen-Morrison composite shoe was small but effective and few in attendance at the conventions failed to stop and study it. The persistence with which composite brake shoes are brought to the notice of the railroads indicates that a belief exists that modern trains with their weights and speeds require a brake shoe with a power of slowing the wheel much greater than any that can be obtained from iron or steel, whether separate or combined. The success of composite shoes on elevated and street railroads seems to have been fully established, and the efforts to adapt them, successfully, to steam roads will be watched with much interest.

—The first exhibit of rolled steel car axles ever made was shown by the Keystone Axle Co., Pittsburgh, during the second convention. It was not a large exhibit, but its importance can hardly be overestimated. In April, 1897, we published a description of the process by which these axles are produced. At that time the parts of the immense rolling mill were being assembled, and in two or three weeks after the first attempt was made to sell axles. Various unforeseen defects in the mill—more especially in the dies—were developed, but nothing to discredit the general principles on which the machine was constructed. The changes which had to be made required much time, and it is only within the last two or three months that the mill has been really perfected. Now contracts for axles are being accepted and filled. The exhibit consisted of an axle taken from stock and rolled to finishing dimensions; the half of an axle cut longitudinally through the center and showing the entire mass of steel to be flawless and as perfect in every respect as any hammered axle ever turned out; and short sections of axles cut transversely and showing equally high grade steel. Every one who examined this exhibit felt that it indicated the beginning of a new and great industry in this country.

—The expanded steel flexible covering for air brake hose, shown by Wm. Yerdon, attracted much attention. It should very greatly increase the durability of hose, and Mr. Yerdon will undoubtedly get a great many trial orders as a result of his exhibit.

—The exhibit of the Cook Cooler Co., Flint, Mich., was substantially the same as last year, but it was the only one of its kind and was unique in the amount of information which it gave and the intelligence and skill with which it was handled. The large and lurid pictures were not for display only. Each conveyed a practical lesson, profitable to the railroad whose officials learned it.

Important to Railroad Managers and Master Mechanics.

**SIBLEY'S Perfection Valve Oil.**

More perfect valve lubrication and entire freedom from corrosion or honeycombing of cylinders, and destruction of joints of steam chests by fatty acids.

In Exclusive Use on Nine-Tenths of the Railroad Mileage of the country.

Reference furnished upon application.

MAKE EXCLUSIVE SPECIALTY OF VALVE AND SIGNAL OILS FOR RAILROAD USE.

**SIGNAL OIL CO.,**

FRANKLIN, PA.

J. C. SIBLEY, President.

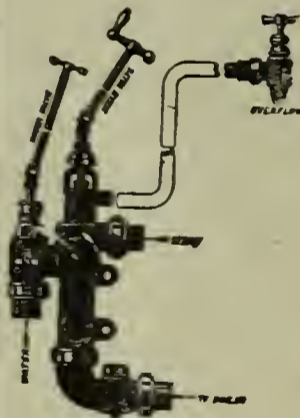

**THE NEW "NATHAN" AND MONITOR INJECTORS FOR LOCOMOTIVES.**

"Nathan" Sight-Feed Lubricators For Cylinders and Air Brakes.

STEAM FIRE EXTINGUISHERS for Switching and Yard Engines.

BOILER WASHERS, BOILER TESTERS, ROD AND GUIDE OIL CUPS, ETC.

NATHAN MANUFACTURING CO.,

92 and 94 Liberty St., NEW YORK. 147 & 149 Van Buren st., CHICAGO.

**Galena Oil Co.**

FRANKLIN, PA.

CHARLES MILLER, President.

Galena Oils are the Standard Railway Lubricants of America.

Galena Oils are used exclusively on nineteen-twentieths of the total railway mileage of the United States, Canada and Mexico.

Galena Oils lubricate the fastest trains of the world, and hot bearings as a result of defective lubrication are unknown to the patrons of the Galena Oil Company.

Galena Oils are manufactured exclusively by GALENA OIL CO.

Principal Office and Works:

Franklin, Pa.

**THE GRAVITY CAR COUPLER.**

AN ABSOLUTELY AUTOMATIC COUPLER.

Cuts the Cost of the Vertical Plane Type in Two.

THIS COUPLER takes the ordinary Link.

Is always ready to couple.

Works on heaviest curves.

Gives a center draft.

Is compact, light and strong.

The latch cannot

jump up, or creep

up, and release link

by motion of the

cars.



The Latch.

IT HAS STOOD THE SEVEREST SERVICE TESTS IN MOUNTAIN AND YARD SERVICE FOR MONTHS. WEIGHT, COMPLETE, 145 LBS.

For details address

The Gravity Car Coupling Co.,

Colorado Springs, Col.



NO PINS TO BUY.

NO KNUCKLES TO BREAK.

# RAILWAY MASTER MECHANIC

WALTER D. CROSMAN, Editor.

EDWIN N. LEWIS, Manager.

PUBLISHED MONTHLY BY

THE RAILWAY LIST COMPANY.

Devoted to the interests of railway motive power, car equipment, shops, machinery and supplies. Communications on any topics suitable to these columns are solicited.

Subscription price, \$1.00 a year, to foreign countries \$1.50, free of postage. Advertising rates given on application to the office, by mail or in person. Address

THE RAILWAY LIST COMPANY,  
The Rookery, Chicago, Ill.

The Official Railway List is Published by this Company.

VOL. XXI. CHICAGO, AUGUST, 1898. No. 8.

Just now, when there is every evidence of an increased purchasing power of the railways, it may be well to speak of one feature of the relations between buyer and seller of railway supplies. We refer to the "expense account" of the seller and his agents. This "expense account" is a well recognized factor in nearly all commercial lines; but in times past it has assumed a magnitude in the railway line that has been quite out of proportion. Since the general breaking down of 1893-4 this account has been very rigidly pared, however, and, with all due deference to the arguments of some of the "boys" on the road, we think very wisely so. Admitting for a moment, for the sake of argument, that these heavy accounts are necessary, let us put forth this fact—not a theory—that close observation of the habits of some of the "supply men" with unlimited expense accounts reveals an expenditure of "expense money" in very many cases upon others of the same fraternity—upon parties the makeup of which included, much of the time, 100 per cent, and the balance of the time 99 per cent, of supply men. Of what value, then, is the expense account to "the house"?

A merchant may well entertain his customer on occasion, but it is unwise to over-entertain him. If A gets business from B by over-entertaining, all the lessons that human nature gives us lead us to the absolute belief that C, by going A one better, will eventually get next to B. Some one said years ago that "every man has his price payable in the currency of his desires." That is a rather broad proposition; and it comes pretty closely to truth. But the currency of a man's desires is not necessarily found in the nature of that which is produced by what is ordinarily termed "expense money."

But aside from this view, the simple fact of the case is that all goods should be sold upon their own intrinsic merits considered with reference to their price. And in any way that may be figured out the final result will be found, by the honest inquirer, to be involving simply a matter of quality and price. The conscientious purchaser will be for but a short time fooled by the low price unless the latter be accompanied by truly good quality. And the reckless recipient of favors coming through "the expense account" will in time be brought by his company to a similar recognition of the fact that price and quality—and those only—must rule in the purchase of supplies. The sellers are already learning that they can do business without ostentatious display of so-called hospitality.

## THE CHICAGO CAR FOREMEN'S ASSOCIATION.

The necessity for an organization which shall have for its active members those employed by the car departments of the different roads centering in Chicago, has long been apparent. By this membership meant the car foremen having general charge of the interchange repair stations, the foremen of the repair shops or repair track and the inspectors through whose hands pass daily the thousands of cars that are interchanged at Chicago.

The Western Railway Club does not fill the gap.

The members, or at least the most active participants in its proceedings, are as a rule the executives of the motive power departments. As a natural thing it could not be expected that they would be personally informed of all the little details of car department work. They have up before their meetings the deeper and more technical questions for discussion. But a few of the car foremen and perhaps a very few of the car inspectors are interested in these scientific questions. There are, moreover, a great many questions brought up before the Western Railway Club for discussion which have no immediate bearing on the business of the car department. Therefore with the idea of having an association which would be for discussion altogether and distinctively of car department matters, a few of the representative car foremen of Chicago met and organized the "Car Foremen's Association," the object of which was the gathering together of all those in any way interested in car department matters, with a view of exchanging ideas, and for the purpose of education and harmonious action.

It might almost be said that the inspectors who daily handle the cars interchanged at Chicago are the ones that it is most necessary should become members of this new association. The nature of their duties is such that they are employed from ten to twelve hours per day and are confined to a limited territory. They thus do not have the opportunity to exchange ideas with the others of their craft as they should. They receive orders from the head of their department to do this or that, to be governed by such and such a rule, and generally they do not have the whys or wherefores explained to them. If they are made to understand why they should do this or that they would be able to act with much better judgment and intelligence.

It is pretty generally agreed that the responsibility resting upon the car inspector is very great. The safety of the train is entirely in his hands. It depends upon him largely whether a train leaving a division point is enabled to run to its destination on time. Neglect on his part will cause a detention to the train in the way of holding it to set out bad or der cars, to repack boxes, exchange brasses, or a hundred other things. Furthermore, in the matter of interchange the car inspector makes himself felt very strongly.

Organization and an exchange of ideas by inspectors and foremen mean that they will be made to look at questions in the same light. Very likely there will always be a difference of opinion; but the way to get them to one way of thinking is to have them meet one another, and then any question that arises and is not understood can be discussed and a common opinion arrived at. Personal acquaintance among the different inspectors is also a means of making a rough road smooth. Two men who are known to each other only through a medium of correspondence are apt to be much greater sticklers for their pound of flesh, than if they had a personal acquaintance. Personal acquaintanceship is very conducive to an enlargement of the principle of give and take.

At a large interchange point like Chicago, where inspectors for the different railroads are located miles apart, they seldom if ever become personally acquainted; yet they do a vast amount of business for the companies which they represent, handling it through the mails. Under the present system of interchange a very little difference in the interpretation of a clause in the M. C. B. rules may cause a car to be returned to the delivering road, which means extra switching charges, delay to equipment and blockades of valuable track room. This trouble may be obviated by organizing the car foremen, car inspectors and car repairers into one body where meetings can be held and the difficulties pertaining to their department discussed. Each one is thereby benefitted by his neighbors' experience. He will get the same interpretation of the rules; and if the inspectors located at the different interchange points become personally acquainted they will understand each others methods of handling cases in everyday work and the results will be that each one will have confidence in what the next inspector will do with the cars that he passes. Accordingly delays to freights and rehandling of bad order empty cars will be reduced to a minimum.

To meet these conditions the association above referred to has been organized and is now in flourishing condition. We give elsewhere in this issue

some account of its work up to date; and in our account it will be noted that this journal has undertaken to give each month a record of its current proceedings. The association is fully worthy of the hearty support which we understand the higher mechanical officials of Chicago roads have given and propose to give to it.

## A PROPOSED JOINT TESTING LABORATORY.

One of the most important committees to be appointed by Mr. Quayle, president of the Master Mechanics' Association, and which, on account of its importance, demands that the members composing it be of the highest ability and entirely free from narrowness in their views, is the committee which will examine into and report upon the question of establishing a testing and inspecting bureau which shall be available to all railroads desiring to make use of the same. No doubt much good could be accomplished by such a bureau in work confined to the motive power department, but it would have been extremely timely had a similar committee been appointed from the Master Car Builders' Association, the two committees to work in harmony, because the greatest benefit from such an institution would be enjoyed by all companies handling interchange cars, should expectations be met by improvement in the quality of material used in the manufacture of such cars.

It is fair to assume that probably the majority of the members of the committee will be men who have charge of both locomotive and car departments and on this account the report of the committee may be expected to cover the views of both associations, but when questions of such importance receive the attention of either association the necessity of a consolidation of the associations is the more apparent, if indeed it does not make apparent the necessity of an association which shall have more authority than either of the associations have now, and more than the combination will have.

Those who have urged recently the organization of a new association which would be more exclusive than either of the present ones by limiting the membership of mechanical officers to those who have charge of both car and locomotive departments and which would be given more authority by the railroads through the general superintendents, who would be members, may have had in mind the consideration of just such questions, although a far different reason was given for forming a new association.

There are many questions arising in the motive power departments, the conditions surrounding which on the various roads bear a sufficiently close similarity, so that results of tests in one locality will serve as basis for practice in another locality; and the growing tendency of requiring the mechanical departments to enter into the spirit of competition just as actively as do the traffic solicitors, by keeping secret certain methods of operation, can be satisfied by placing upon the mechanical officers the responsibility of applying certain truths to practice when such truths have been established by the common laboratory.

Any road is most prosperous when all roads are prosperous; there is no road which is so self contained that it can prosper without the assistance of other roads or without assisting other roads, so it behooves each one to help the others. This cannot be better done than by establishing a common laboratory where truths of peculiar interest to railroads may be sought out and the application of them left to the officers of the individual roads. There are, of course, many questions arising which are surrounded by conditions peculiar to individual roads and these must be investigated by the individual road.

The present arrangement for the interchange of freight equipment would make such a laboratory extremely valuable to the car department, providing an understanding could be arrived at that all material, or at least all that used in trucks, draft rigging and other equally vital parts, entering into the construction of cars to be used in interchange should pass inspection by this laboratory. The decided tendency to make "owners responsible" is worthy of much praise, but "owners responsible" does not pay for wrecks caused by faulty construction or bad material in foreign cars nor, apparently, does it prevent the building of "the cheapest car possible" be-

cause "our cars are always on foreign roads." There are managers who are bold enough to say these things and who are unprincipled enough to build such cars and send them to foreign roads to cause wrecks and to earn the pittance of a mileage. The continuance of such practice must result in the organization of a committee which shall pass upon the design of all cars to be offered in interchange and the inspection of the material and construction by a common department of inspection and test; otherwise it would seem that the practice of interchanging cars will gradually become obsolete. There are a number of large systems which now make strenuous efforts to keep their own cars on their own lines, and it is hardly necessary to say that these roads are building cars which they believe will carry safely the loads allowed.

Were such a laboratory established there would be, probably, no question about the method of lauding it because there are several parallel organizations being maintained by the railroads now, such as the Western and the Eastern Railway Associations, in which any road, a member, can make demands for information and the same information may or may not be furnished to each member.

#### OILING JOURNAL BOXES.

During the discussion of the report on the "Care of Journal Boxes," at the recent meeting of the M. C. B. Association, criticism was made of the usual practice of car oilers of lifting the lid of the box and giving a dab of oil without looking to see whether the waste was in contact with the journal or whether oil was needed. The opinion was then expressed that frequently all that was needed was a stirring up of the waste to bring it into contact with the journal.

Generally the oil applied by a car inspector or oiler, at stations where only a hasty inspection is made, strikes the end of the axle and falls onto the waste in that part of the box where it is least needed. The idea of stirring up the waste and bringing it into better contact with the journal is a good one where the usual form of car boxes is concerned, but it should be understood that this procedure is not advisable for all forms of boxes. It is a very good practice for boxes in which the source of lubrication is below the surfaces to be lubricated because the sand and grit will be carried the more readily to the bottom of the box away from such surfaces and there will result the good effects of bringing the waste into better contact with the same. There can be no serious objection to using a second time fairly well cleaned waste in such boxes, because the oil will carry the grit to the bottom. With boxes in which the lubricating material is above the surface to be lubricated, however, extreme care should be used both in stirring up the waste in the box and to insure that no waste is used which contains grit to be washed down to the bearing surfaces.

It will thus be seen that the action which produces good effects in one style of box will produce just the opposite in the other; with the latter form of box it will be found expedient to allow the waste to settle quite firmly and remain so in order that the oil will work through more slowly and at the same time strain out the grit more thoroughly. It will be found advisable, also, in this form of box, to pack the waste in layers and at intervals to remove the top layers which have caught the grit and replace them with layers of fresh waste.

Aside from the features mentioned above, of top and bottom lubrication of journals, experiments have shown that the best lubricating results are obtained when the lubricant is applied where the surfaces to be lubricated are subjected to least pressure and at a point from which the lubricant will be carried to the place of greatest pressure in the shortest time; the latter provision being to minimize the chances of the lubricant escaping before accomplishing the object for which it is applied. This point on car and locomotive carrying-journals which run in either direction is just at the lower edge of the brass and at either side of the journal; although for extreme fineness and for locomotives which run forward most of the time the best place would be the backward side of the journal. The reason why it is best to apply the lubricant at the point where there is least pressure is that a film will form on the surface and as the journal revolves the film will be carried between the two surfaces and keep them

separated, as they should be; whereas, when an attempt is made to lubricate at a point where there is great pressure between the surfaces, the surfaces are already in contact and the pressure is frequently too great to allow the lubricant to work in between them.

Some journals are lubricated at the place of greatest pressure—driving journals of a locomotive partly so—and a groove or a larger opening is cut in the bearing; in such cases the groove provides a place where there is no pressure, but the edges of the metal around the groove are generally the places of maximum pressure and offer great resistance to the passage of the lubricant to the bearing surfaces. When the lubricant is applied at the lower edges of the brass the film works gradually from the place of least pressure to that of greatest pressure, and its function is the more surely performed. Grooves in the bearing should be cut nearly the full length of the bearing—near enough to insure lubricating the full length, and not near enough to allow the lubricant to escape at the ends of the grooves.

#### MUST PROVE IGNORANCE OF DEFECTS OR EMPLOYER'S PROMISE TO REMEDY THEM.

The supreme court of Ohio says that the general rule is established in that state and elsewhere that in an action by an employe against his employer for an injury resulting from the latter's negligence in furnishing machinery or appliances, about which he was employed, he must allege that he was ignorant of the defect from which the injury resulted; or that, having knowledge of such defect, he informed the employer, and continued in the service, relying upon his promise to remedy the defect. This requirement is not answered by an averment that the injury occurred without fault of the employe. The reason given for this is that the employe must be required to communicate to his employer such knowledge as he may have of defects in machinery or appliances about which he is employed, or the law will not be administered according to the reason which is its life.

Fully justified by considerations of policy, the supreme court goes on to say, the courts require of railway companies with respect to their patrons and the public the exercise of that high degree of care which is commensurate with the dangers of their operation. To the end that such care may be exacted from them they are, with obvious propriety, charged with knowledge of such defects as are or might be discovered by the senses of their officers and employes. It is with like propriety that the communication of such knowledge is required from all with whose knowledge they are chargeable.

Nor does the court consider that the Ohio statute of April 2, 1890, which applies to railroad corporations only, releases the employe of a railroad company from this general rule. That statute makes it unlawful for any such corporation to knowingly or negligently use or operate any car or locomotive that is defective, or upon which the machinery or attachments are in any manner defective, and provides that if an employe shall receive any injury by reason of any defect in any car or locomotive, its machinery or attachments, the corporation shall be deemed to have had knowledge of such defect before and at the time such injury is so sustained, and proof of the defect shall be prima facie evidence of negligence on the part of the company.

The foregoing statute, by its terms, the court says, affects the rules of evidence. It does not affect the duty of the employe, nor the rules of pleading with respect to it. In the cases to which it applies it raises against the corporation a prima facie presumption of negligence from evidence showing that the employe received an injury by reason of a defect in the car or locomotive, or the machinery or attachments thereto belonging.

Applying these principles to the case of Hesse against the Columbus, Sandusky & Hocking Railroad Company, the court holds that, in order to recover damages from a railroad company for a personal injury received by a fireman in consequence of defects in the locomotive upon which he is employed, as, for example, a locomotive that exploded in consequence of its weak and defective condition, it is necessary to allege, in the petition, that he had no knowledge of such defects, or that, having such knowledge, he informed his superior, and continued

in the service relying upon his promise to remedy the defects.

On the trial of an action by an administrator to recover damages when such injuries have proved fatal, the court also holds, it is not competent to call witnesses to testify that the deceased fireman was in the line of promotion when the injuries were received.

At the convention of the Master Car Builders' Association held in June, 1898, the matter of marking the light weight upon cars and having them corrected from time to time as necessity requires, was discussed, and in view of the increasing practice of loading locomotives on a tonnage basis, the matter was referred to the executive committee for consideration. The executive committee has instructed the secretary to call the attention of all car owners to the importance of stenciling the light weight upon their cars, and of correcting it when the occasion requires, in order to facilitate the business of economical operation. All car owners are, therefore, requested to give this matter prompt attention, and to arrange for the correct light weight to be properly stenciled upon their cars.

#### COMMUNICATIONS.

##### Air Brake Hose Tests.

To the Editor of The Railway Master Mechanic:

In the matter of specifications for air brake hose I would like to call your attention to some facts of interest, inasmuch as few railroad men have any knowledge of rubber, and consequently specifications are put out which in no way show the value of air hose when tested by them. Rubber has no tensile strength worth considering in air hose. The strength is alone given by the cloth or "duck" fabric, which has soft rubber forced through its interstices, merely to stick it together and form an air tight structure, when the same is rolled around the inner tube. Now the soft sticky rubber often used for this purpose (and which is necessary if the hose is to fill the test of unwinding it by a 25-lb. weight at the rate of 12 in. in 20 minutes), is responsible for the stiffness and breaking of hose after its use a few months, because this soft rubber hardens (not being sufficiently "cured"), and the hose soon gets rigid and kinks when it is forced out of its usual position, by hanging it on the dummy coupler. If, now, this rubber used on the "duck" or cloth were of a different mixture and more perfectly cured—in which case it would not fulfill this unwinding test—it would remain flexible much longer and give a much longer life as a hose.

To demonstrate this fact, and also the fact that hose that will fill this unwinding test when new will utterly fail in doing so (because of the hardening of this "friction" rubber) when the hose are from three to five months' old, the writer took off from a car an air hose which had been in use less than five months, and which was one of a lot which had passed this unwinding test, and subjected it to the same test. The result was that it failed utterly because the "friction" rubber had so hardened as to become brittle, the very process of unwinding subjecting this rubber to a breaking action, like snapping off a pipe stem, yet when this rubber was new and soft, it acted as a rope in tension.

This hose was quite stiff and rigid, and wanted little more bending and straightening out to crack the hardened rubber and force it to kink.

This 22 inches of hose had cost the road nearly one dollar, while a similar length of hose, on a different road's car, which had been in use 14 months and had cost its owner about 70 cents, was flexible and showed no signs of kinking.

Of what use, then, are tests which result in short-lived hose? If a senseless test is required, why not tie an air hose into a knot, place it in the sun at 10:30 a. m., and reject it if it fails to throw a shadow 12 inches long? Such a test would at least be an improvement on the unwinding test, which is certain to secure a short-lived hose. Requirements like the C. B. & Q. R. R. are to the point—because they test the hose in the line of use they will be put to. An eastern rubber company makes a hose using no duck, but a heavy flexible web of twine, and a most excellent article results. How, then, can such hose be tested by the senseless unwinding test?

The proper test is one of service, leaving the maker of the hose to make it as he will and of his own mixture of rubber, and not tie him down to a soft, sticky mixture which must result in short-lived hose. Experience and common sense in the matter of cast car wheels has generally made the test one of service—either in mileage or in time—leaving the wheel maker free to use any mixture he pleases, so long as he gives the service and a satisfactory price. What could be more sensible than to extend this method to air brake hose? That is, buy of a reputable and responsible manufacturer and require a certain life for the hose. If his hose fails he is the loser. The railway company

can lose nothing. It pays for so much service, and gets it, and the result of this has been the best and cheapest car wheel for freight service in use in the world. But would this have resulted had some railroad, or manufacturer of wheels, put out requirements that a machinist weighing 180 lbs., with a chipping hammer and a  $\frac{3}{8}$  cape chisel, must not be able to chip a slot or groove  $\frac{1}{4}$  in. deep and 12 in. long in the plate of the wheel, in 20 minutes? I rather think not. Would such a test show the depth of the chill, flat spots or "cold sluts"? And yet such an arbitrary, empirical test is quite as sensible as the unwinding test for air brake hose. Yours,

Master Mechanic.

Deterioration of Steam Dry Pipes.

Tulare, Cal.

The Editor of the Railway Master Mechanic:

A great deal has been said from time to time about the deterioration of iron steam dry pipes. The claim has been made that bad water is an important factor in their destruction, which is possibly true. From my own observations of cause and effect and also from my experience with collapsed dry pipes I have reached the conclusion that the most destructive agent is the water of condensation.

Now let me make myself understood: We well know that the water of condensation from a surface condenser cannot be used exclusively as feed water in a

of this object the executive committee instructed the secretary to suggest the Railway Equipment Register, of New York city, as a suitable medium through which to disseminate this information in complete form.

NEW AIR BRAKE INSTRUCTION CAR—N. Y., N. H. & H. R. R.

A number of air brake instruction cars have been built since the first was put into service almost ten years ago, all of the same general plan as the original, but each having minor modifications thought to be improvements. The latest design is shown by the accompanying cuts from photographs and drawings of the New York, New Haven & Hartford car, which has just been completed at the New Haven shops of that road under the direction and in accordance with the ideas of Mr. J. L. Andrews, general air brake inspector, under whose charge the car is operated.

The interior of the car is divided into three compartments—an office, instruction room and a boiler room. The office contains two beds made up from "pull-out" seats, two upper berths, a desk, chairs, wash-stand and commodious wardrobes with draw-

ters, to the top of which are fastened the various parts on spindles so that they may be revolved or turned without removal from the table. On the side wall of the car is the passenger brake, consisting of rigging for engine, tender and two cars; and sectional governors, injectors, lubricators, pop valves and other apparatus of interest to railroad men. On the side deck at an angle is a model of the connections under a passenger car. Small levers in correct proportion are mounted on a board, and connected by means of tension scales in such a manner that when power is applied at the point corresponding to the brake cylinder each lever moves a relative distance and the amount of resistance at any particular point can be ascertained by means of gauges on the scales.

The separation of the boilers and pumps from the instruction room is a new feature and is found to be of much benefit in confining the dirt, noise and heat.

The boiler, pumps and work bench occupy one side of the car, with lockers, coal box and feed water tank on the opposite side. In the clerestory are tanks which furnish water to the wash-stands, and which can be filled from the roof, or from the main tank by means of the feed pump.

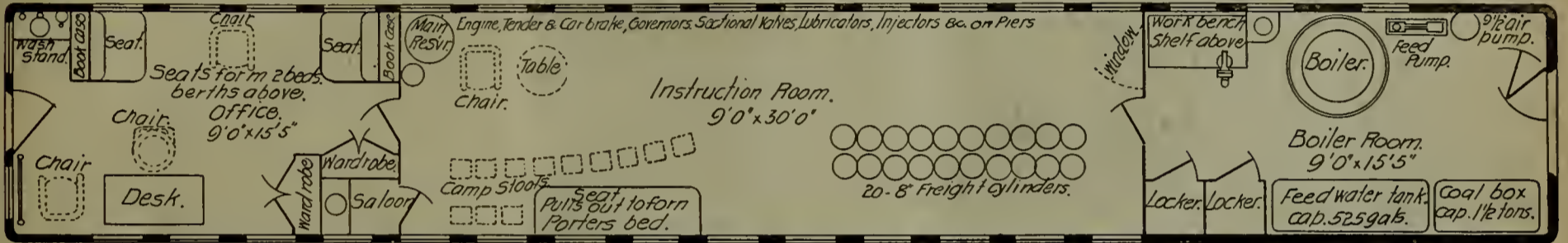

AIR BRAKE INSTRUCTION CAR—N. Y., N. H. & H. RY.—FLOOR PLAN.

marine boiler on account of its pitting quantities. As the steam of salt water is fresh, so the steam of so-called bad water where condensed is chemically pure. Now how do we connect this aqua pura with the gradual destruction of dry pipes? Any one who has given any particular attention to collapsed dry pipes has noticed that with hardly any exceptions they give out on the top side, with the rupture greatest at the front end. Now there must be a cause for these conditions. Why does the greatest trouble occur toward the front end? Did you ever notice when taking out dry pipes that they are invariably rusty on top or that if they are not rusty on the top side when first taken out they will rust at that point by exposure to the weather?

When boilers are allowed to cool off the steam condenses and adheres to the inside of the boiler in the form of drops of water. The continual dropping of this distilled water on the dry pipe produces a pitting or eating away of the metal; the process is slow but sure.

We can get an illustration of the destructive features of distilled water right in our own home. We use hard water in our teakettles; the foreign substances held in solution in the water are deposited as scale by the application of heat. So much for the teakettle. Now let us examine the lid and what do we find. We find a rusting or eating away of the metal at the joints or where the lid is put together. What causes it? Simply the water of condensation. If we want another illustration let us examine the under side of the cast iron lids on the hot water reservoir of our kitchen stoves and notice how they are pitted.

Now as to why the dry pipes weaken most at the front end: My first idea is that when the boiler cools down the front end cools first and the steam drifts toward the cool surfaces where condensation is more copious; hence there is an increased precipitation at that point. Am I right or wrong in these theories?

W. de Sanno.

(Where there is sufficient lime in the water to prevent it this action will not take place. It is a fact that pure distilled water will rust, corrode and pit iron pipes, and this is due to the presence of carbonic acid which supplies oxygen for oxidization or rust. When water contains lime or other salts the  $\text{CO}_2$  is taken up by them and is not an active agent. We may add that pitting takes place on sheets that are entirely submerged, and the dropping theory is not therefore necessary to explain it.—Ed.)

At the convention of the Master Car Builders' Association held in June, 1898, the secretary was instructed to urge upon all car owners the importance of publishing a complete classification of all cars which they own or control, such publication being regarded as of great advantage to all concerned and practically essential to the satisfactory transaction of business with the operating lines. In furtherance

of this object the executive committee instructed the secretary to suggest the Railway Equipment Register, of New York city, as a suitable medium through which to disseminate this information in complete form.

ers for linen below. Above and back of the seats are small book cases built into the finish. The instruction room contains 20 freight car brakes which are placed to one side and toward the end opposite the main reservoir. While these are not in such a position as to prevent access to any particular cylinder or part, yet they are in a position to give the greatest available floor space near the reservoir. This space is about 17 ft. by 9 ft., and the greater part of the instruction can be given here with the instructor beside the main reservoir and the class seated on camp stools opposite, where they can see any part of the apparatus and can give all their attention to the instruction without having their minds taken up with the thought that they are getting tired, as would be the case were they compelled to stand during the sessions.

Mr. Andrews has a convenient means of showing the sectional brake valves—a revolving table on cas-

The usual side baggage doors, which have heretofore been thought to be a necessary evil in connection with instruction cars, are missing, but the end door in the boiler room is in two parts so that when these are entirely back the whole end is practically open, permitting the removal of the boiler and tanks, and serving as a good means for ventilation.

The boiler gauges are on the back of the boiler in such a position that they can be readily seen by the instructor from his position alongside the main reservoir.

There is also a complete set of gauges over the desk in the office.

The car can be heated either from an outside plant or from the boiler. The connections for the three rooms are separated so that the temperature can be regulated in any part of the car without reference to any other part.

The absence of piping in the instruction room is

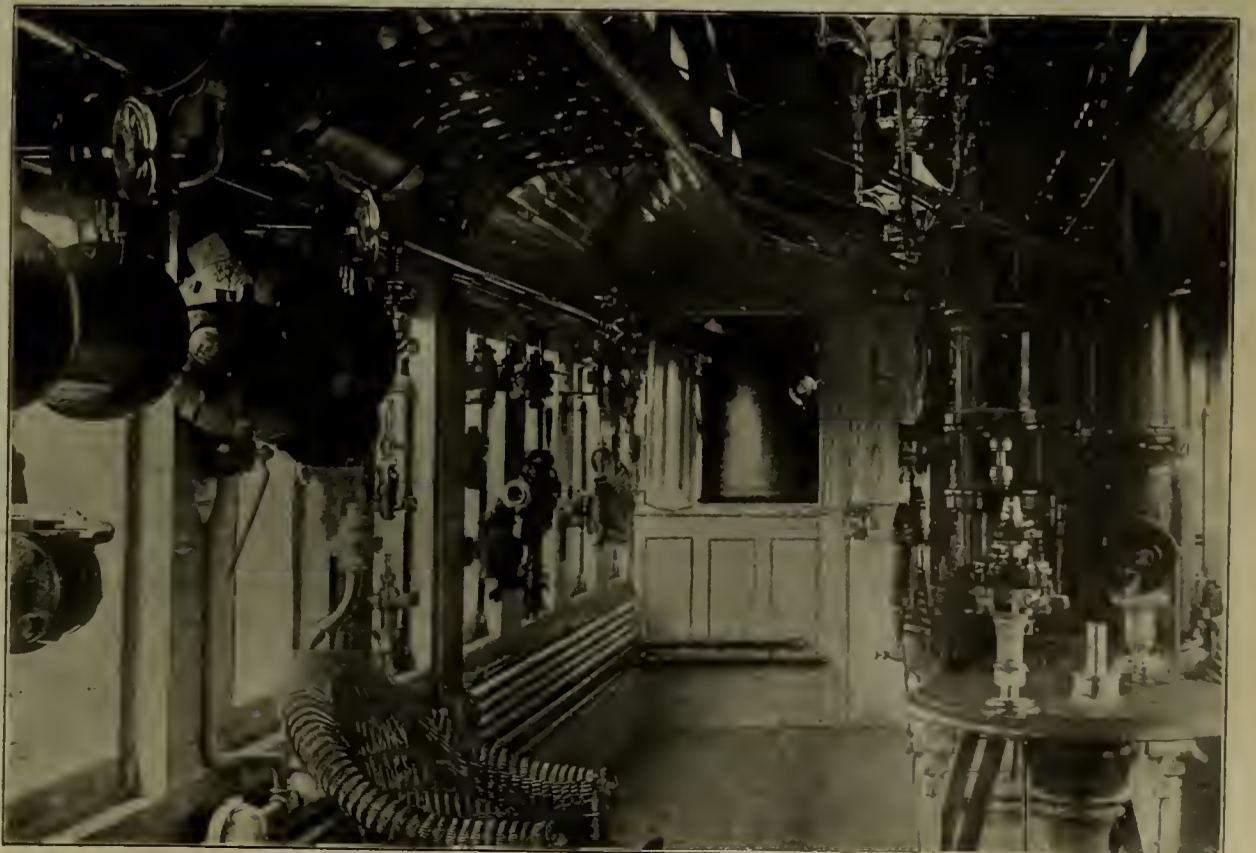

AIR BRAKE INSTRUCTION CAR—N. Y., N. H. & H. RY.—INSTRUCTION ROOM; LOOKING TOWARDS BOILER.

quite noticeable. Wherever possible the piping has been placed between the sills underneath the floor, but convenient floor plates make it possible to control any portion of the piping without leaving the room, and by the same means the main reservoir can be connected to the car train pipe to take air

seats and valve gear, cylinders and piston rod and valve stem packing, are affected by high steam pressures. There seems to be no question but that higher steam pressures mean increased wear of the valves and seats, and possibly of the link motion, due to the drag of valves even as well-balanced as the ordinary slide valve may be. This is of course directly due to the pressure.

High-pressure engines, 1 32-100 cents.  
Average monthly mileage, 5,129.  
Low-pressure engines, 1 18-100 cents.  
Average monthly mileage, 3,529.

An increase in the running repairs of the high-pressure engines as compared with the low pressure of 12 per cent. Even here, however, the engines carrying the high pressure are much the heavier, and upon a ton-mile basis, instead of a train-mile, the balance is the other way.

It is evident that the available data are too meager to admit of any positive conclusions, but it seems the more probable that the use of high steam pressures need not be attended by any considerable increase in the cost of repairs.

PRESSURE VS. CAPACITY.  
By Wm. Forsyth.

It may be assumed that the efficiency of a locomotive may be increased either by increasing the pressure on the boiler or by increasing the size or capacity of the boiler. If the pressure is increased, the gain is to be found in the improved performance of the engines; if the pressures remain unchanged and the boiler is made larger, its evaporative efficiency, when developing a given power, will be increased. Either an increase in pressure or an increase of capacity involves greater weight, and as the cost of a boiler of any given type will be approximately proportional to its weight, the whole question may be resolved into the following statement, namely: Shall any added weight which may be given the boiler of a locomotive be devoted to increasing its strength that a higher pressure may be carried, or to increasing its capacity that it may render its service while working at a correspondingly lower rate of power? The following table presents some facts bearing on this question:

SHOWING CHANGE IN WEIGHT OF BOILER WITH STEAM PRESSURE.

Steam Pressure	PRESSURE.	
	Weight of 60-in. Boiler.	Weight of 52-in. Boiler.
I	II.	III.
140	.....	21035
150	33121	.....
180	35253	.....
210	38513	.....
240	39035	.....
250	.....	25775

This table gives, in Column II, the weight of a 60-inch boiler suitable for a Mogul or ten-wheeled engine designed for different pressures varying from 150 to 240 pounds. The values given in this column are estimates supplied through the courtesy of the Baldwin Locomotive Works. Column III of the same table gives weights of the boilers of the Purdue experimental locomotives, No. 1 and No. 2 respectively, which are in every way similar, excepting that one was designed for a pressure of 140 pounds and the other for a pressure of 250 pounds.

It will be seen that an increase in steam pressure from 150 to 240 pounds in a 60-inch boiler necessitates an increase in weight of 5900 pounds or of 18 per cent, and that an increase in steam pressure from 140 to 250 pounds in a 52-inch boiler necessitates an increase in weight of 4700 pounds or of 22 per cent. It will, therefore, be sufficiently accurate for our

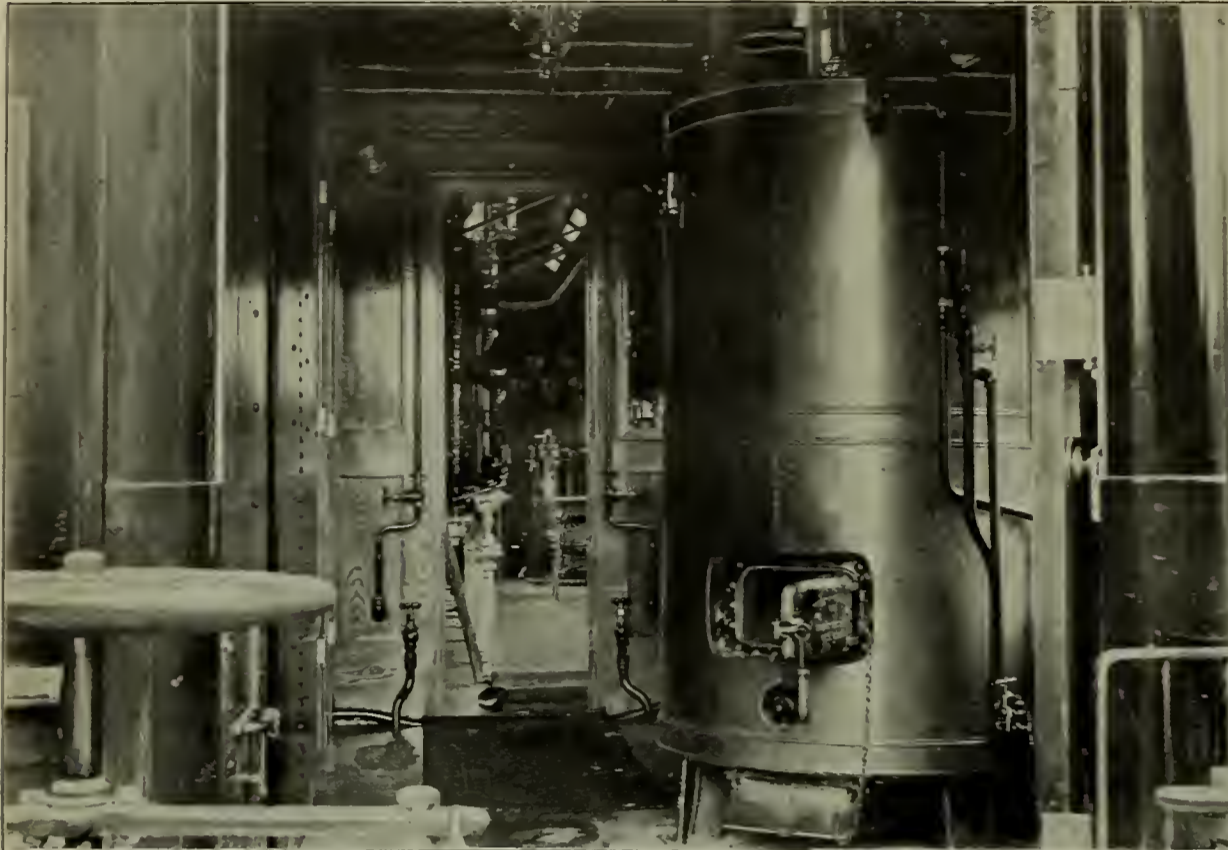

AIR BRAKE INSTRUCTION CAR—N. Y., N. H. & H. RY.—BOILER ROOM.

from stationary plant or from a locomotive if for any reason the boiler cannot be used.

The car is mounted on six-wheel trucks, and the platforms have trap doors over the steps and gates similar to those on an observation platform. Its total length is 61 ft. 5 in., width 9 ft. 6 in., and it weighs 120,000 pounds. The photographs and drawings are furnished through the courtesy of Mr. John Henney, superintendent of motive power; and for our descriptive notes we are indebted to Mr. W. G. Cory, chief draftsman.

in combination perhaps with the difficulty of obtaining sufficient lubrication with the present oiling devices, especially at high speed and short stroke. Those who have used piston valves appear to consider that they meet the requirements of high pressures much more nearly than any other form. The cylinders and piston packing rings are also probably affected by the severer service (see Proceedings, A. R. M. M. Association, 1897, page 197) as well as the boiler mountings. Rod packing of soft metal may be melted by the higher temperature of the steam with which it comes in contact and harder mixtures required.

One railroad reports the performance of ten engines carrying 200 pounds pressure, in service from eight months to one year, as compared with the same number of engines carrying 150 pounds pressure, in service for from ten to fifteen months, the figures given being for four months only.

Cost of running repairs per engine-mile

HIGH STEAM PRESSURE FOR LOCOMOTIVES.

In our last issue we gave the report of the committee reporting to the Master Mechanics' Association on the subject of the "Efficiency of High Steam Pressures for Locomotive Boilers." There were several appendices to this report written by individual members of the committee, two of which we now give, as follows: INCREASE OF PRESSURE AND COST OF LOCOMOTIVE REPAIRS.

By Tracy Lyon.

One of the prime difficulties in arriving at any very definite conclusions upon this subject lies in the fact that the greater number of the locomotive boilers now carrying the higher steam pressures have been in service but a comparatively short time. It is the opinion of some of the best authorities that no conclusive evidence bearing upon the maintenance of locomotives carrying high boiler pressures can be now presented. It should be noted in this connection that by "high pressure" is meant pressure approaching 200 pounds, and by "lower pressure" pressures between 140 and 160 pounds.

While much trouble has been had from some of the earlier boilers carrying 200 pounds steam pressure, in that their construction was to a certain extent experimental, there seems to be no reason why boilers cannot be built to successfully carry such a pressure. A materially increased weight must be looked for, a thickening of the plates and a more substantial staying and riveting; but this being done, it would seem to be established by close observation that the repairs of a boiler, properly designed for the service, are directly as the horse-power of work performed, irrespective of the pressure carried. It has been suggested that the increased temperature of the fire-box sheets, due to an increased temperature of the steam, might injuriously affect the material, and that therefore it is desirable that the steel used in high-pressure boilers should be chosen and treated with special reference to its behavior under such conditions.

Passing to the question of the repairs to the machinery of the locomotive, it is difficult to find any evidence tending to show that other than the main valves, valve



AIR BRAKE INSTRUCTION CAR—N. Y., N. H. & H. RY.—MAIN RESERVOIR.



purpose to assume that a change of pressure from 150 pounds to 240 pounds, an increase of 90 pounds, will necessitate an increase in weight of boiler of about 20 per cent. The benefit to be derived from such an increase of pressure may be judged by reference to other portions of this report. We may next inquire as to the probable effect of converting the 20 per cent increase in weight into increase in capacity.

The evaporative efficiency of a boiler depends on the rate of power to which the boiler is worked. The relation of efficiency and power, as defined by a large number of tests made upon the boiler of Schenectady No. 1, at Purdue, is shown by the diagram herewith given. It will be seen that when the power is such as will require 5 pounds of water to be evaporated per foot of heating surface per hour, 8½ pounds are evaporated for each pound of coal burned; but when 15 pounds of water must be evaporated per foot of heating surface per hour, only 5½ pounds are evaporated per pound of

given type may, within limits, be proportional to its weight. While the gain from increased pressure must for the present remain a matter of some speculation and doubt, that which is to be had through increased capacity is both certain and fixed.

THE CAR FOREMEN'S ASSOCIATION OF CHICAGO.

We are pleased to state that we have made arrangements with the Car Foremen's Association of Chicago to publish each month an account of its proceedings. With this issue we give two papers recently presented at its meetings, but we wish to first give a brief sketch of the history of the association to date.

The Car Foremen's Association owes its existence to Mr. W. E. Beecham, car accountant of the C. M. & St. P. Railway. In September, 1897, Mr. Beecham called a meeting of the Car Foremen and Chief Car Inspectors representing the majority of the railroads doing interchange business in Chicago districts, with a view of obviating all unnecessary handling of empty cars on account of defects existing and if possible of establishing a uniform system of disposing of bad order cars.

After holding several meetings, the committee made recommendations which were adopted at a meeting held in room 560 Old Colony building on Oct. 6, 1897. Mr. Beecham, who was presiding at this meeting, suggested that the movements of cars in Chicago could be greatly facilitated if the car men were organized for the purpose of establishing a uniform practice at all inspection points, and very kindly offered to furnish a room in the Old Colony building for meeting purposes; and on Oct. 6, 1897, the Car Foremen's Association was organized with nine charter members representing the following railroads: P. F. W. & C. Ry., C. M. & St. P. Ry., C. & E. R. Ry., C. & G. W. Ry., W. C. Ry., B. & O. Ry., W. R. Ry., U. S. Y. & T. Co., and the C. & N. W. Ry., since which time the membership has increased rapidly.

The very pleasant room furnished by the C. M. &

St. P. Railway soon became too small; but the executive committee was awake to the demand for larger quarters and, through the courtesy of Wm. Eden, proprietor of the Great Northern Hotel, is now privileged to invite all who are engaged in the maintenance and interchange of cars to meet with it in the pleasant parlors of this hotel.

Regular meetings are held on the second Thursday of each month at eight o'clock p. m. The hour of meeting was originally at 2 p. m., but was changed to 8 p. m., in the hope of getting closer to the inspectors, who found it inconvenient to attend an afternoon meeting. The change resulted in increasing the average attendance from 18 to 125.

The very able paper presented by G. W. Showers, master mechanic of the Canda Cattle Car company, at the June meeting appears in this issue. And the benefits which are noticeable as resulting from the efforts of this association are noted in Mr. Beecham's address to the association at the July meeting, which is also published in this issue.

Chas. Waughop, chief joint inspector of East St. Louis, will address the next regular meeting, which will be held on Thursday evening, August 11. Mr. Waughop's topic will be "The M. C. B. Coupler from a Car Man's Point of View." At the August meeting there will also be a discussion on the M. C. B. rules, as amended at the June convention at Saratoga.

With this brief outline of the association's work, past and prospective, we now give a list of the charter members: T. B. Hunt, general foreman, P., Ft. W. & C.; T. R. Morris, assistant general foreman, C. M. & St. P.; R. R. Jones, car foreman, C. G. W.; H. H. Manthey, car foreman, W. C.; J. J. Callahan, general foreman, B. & O.; S. Upton, assistant general foreman, W. R. Ry.; C. Dean, car foreman, U. S. Y. & T.; R. Wharton, general foreman, C. & N. W.; W. E. Sharp, general foreman, C. & Erie.

The present officers of the association are: President, T. B. Hunt, general foreman, P., Ft. W. & C.

Vice President, T. R. Morris, assistant general foreman C. M. & St. P. Ry.

Treasurer, R. Wharton, general foreman, C. & N. W. Ry.

Secretary, W. E. Sharp, general foreman C. & Erie Ry.

Executive committee: Officers as above, and C. Dean, general foreman, C. J. Ry.; R. R. Jones, car foreman, C. G. W. Ry.; J. J. Callahan, general foreman, B. & O. Ry.

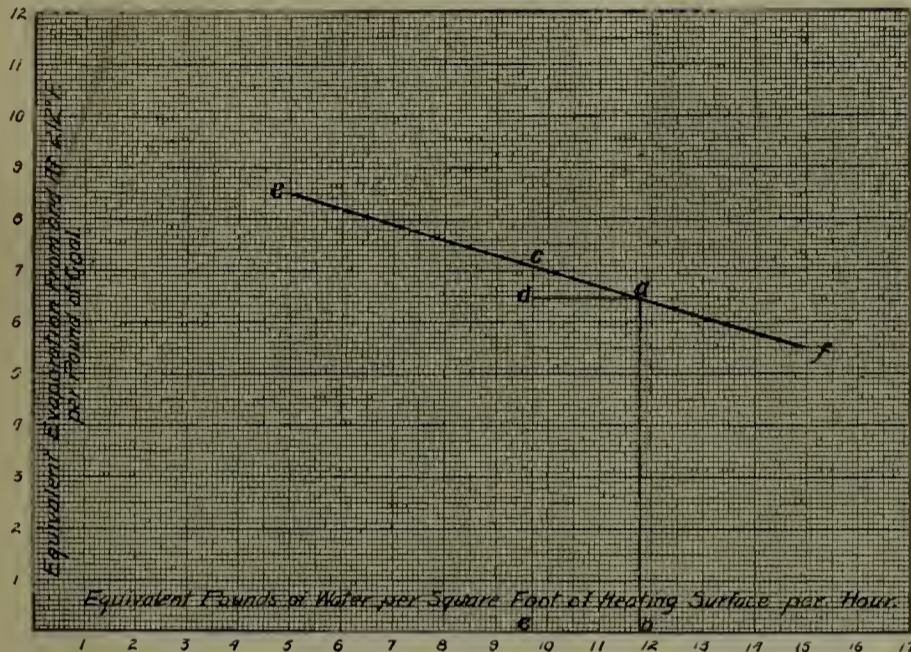

coal. Strictly speaking, the relationships disclosed by this diagram apply only to the boiler from which they were derived, but as all locomotive boilers of usual form may be expected to give a curve of the same general character, that which is presented may be employed as the basis of the following general illustration. Thus, suppose that the demand for steam upon what may be called a "normal" boiler is such as to require the boiler to work at the point *a* on the curve of efficiency. If, now, the same demand for steam is supplied by a boiler whose heating surface is greater than that of the normal boiler, the larger boiler will work at some point, *c*, higher on the curve of efficiency; the increase in efficiency will be represented by the ratio of *cd* to *ab*. An inspection of the figure will show that the value of the ratio depends upon the length of the line *da* and upon the location along the efficiency curve of the initial point *a*. That is, the increase in efficiency depends, first, on the amount of increase of heating surface, and, second, on the rate of evaporation of the assumed normal boiler.

Numerical values, based on the assumption that increase in capacity will be proportional to increase of weight, are given in the following table:

SAVING IN FUEL BY USING A BOILER WHOSE CAPACITY IS GREATER THAN AN ASSUMED NORMAL BOILER.

Pounds of water required to be evaporated per square foot of heating surface per hour in a normal boiler	Percentage saving in fuel by using a boiler whose capacity is greater than the normal boiler, by 5, 10, 15 and 20 per cent, respectively.	5 per cent.	10 per cent.	15 per cent.	20 per cent.
I.	II.	III.	IV.	V.	
5	0.8	1.5	2.2	2.9	
6	1.0	1.9	2.8	3.7	
7	1.2	2.3	3.4	4.5	
8	1.5	2.9	4.1	5.3	
9	1.8	3.4	4.8	6.1	
10	2.0	3.9	5.5	7.1	
11	2.3	4.5	6.4	8.2	
12	2.7	5.1	7.4	9.4	
13	3.0	5.7	8.4	10.7	
14	3.4	6.4	9.4	12.0	
15	3.8	7.4	10.6	13.6	

This table shows that the saving which results from increasing the capacity of a boiler is most marked at high power. Thus, an increase of 20 per cent in the size of a boiler increases the evaporative efficiency only 2.9 per cent under a development of power which would be supplied by the normal boiler, by an evaporation of five pounds of water per foot of heating surface per hour, but increases to 13.6 per cent when the power is increased threefold.

It is perhaps fair to presume that the heating surface, or better, the steam-making capacity, of a boiler of any



AIR BRAKE INSTRUCTION CAR—N. Y., N. H. & H. RY.—INSTRUCTION ROOM; LOOKING TOWARDS OFFICE.

The by-laws of the association are as follows, being given in full that the scope and plan of work and government may be fully understood:

#### BY-LAWS.

##### I.

###### NAME.

This association shall be known as the Car Foremen's Association of Chicago.

##### II.

###### OBJECTS.

The objects of the association shall be the bringing together of those interested in car department matters, for the purpose of forming closer acquaintanceship, exchanging ideas, discussing questions of interest and settling disputes that members may wish brought before it.

##### III.

###### MEETINGS.

Meetings shall be held the second Thursday of each month at 8 o'clock p. m. at such place as may be designated by the executive committee; change of time and place of meeting shall be made only by the executive committee, and the secretary shall notify each member of such change in reasonable time.

##### IV.

###### QUORUM.

A quorum shall consist of ten members.

##### V.

###### OFFICERS.

The officers of the association shall be a president, vice-president, secretary, treasurer, and an executive committee. These officers shall hold office for one year and the election for president, vice-president, secretary and treasurer shall take place during the October meeting of each year.

##### VI.

###### DUTIES OF OFFICERS.

President: The duties of the president shall be to preside over all regular meetings, preserve order, enforce the by-laws, and appoint all committees. He shall vote only when there be a tie.

##### VII.

Vice-president: The vice-president shall assume the duties and authority of the president in the absence of the latter.

##### VIII.

Secretary: The secretary shall keep correct record of all proceedings of the association, carry on all correspondence, send out all necessary notices, keep record of all moneys received and expended, and attend to any other business that the association may direct, and shall receive such compensation as may be decided upon by the association.

##### IX.

Treasurer: The treasurer shall receive and care for all money due the association, report to the secretary his transactions, and not pay out any money without an order signed by the president.

##### X.

###### EXECUTIVE COMMITTEE.

The executive committee shall consist of the officers of the association and three other members to be appointed by the president. They shall have general direction of the affairs of the association, order change in time and place of meeting, and arrange for subjects for discussion. Four members of this committee shall constitute a quorum.

##### XI.

###### MEMBERSHIP.

Any person connected with the car department of any railroad or private line may become a member by making application to the association and being endorsed by a majority of the executive committee.

##### XII.

###### DUES.

Dues shall be one dollar (\$1.00) per year, payable in advance.

##### XIII.

###### ELECTIONS.

All elections shall be by ayes and nays.

##### XIV.

###### VACANCIES.

In the case of a vacancy in the office of the president the executive committee shall order an election to fill out the unexpired term. In case of vacancies in any other office, the president shall appoint a member to fill out the unexpired term.

##### XV.

###### FORM OF BUSINESS.

All business at regular and committee meetings shall be carried forward in the usual parliamentary manner.

##### XVI.

###### CHANGE OF BY-LAWS.

Any changes of the by-laws shall be presented at a regular meeting one month previous to the date upon which action shall be taken, and shall only be agreed upon when approved by two-thirds of the entire membership.

##### XVII.

###### ORDER OF BUSINESS.

Order of business shall be as follows:

1. Opening.
2. Roll call.
3. Reading of the minutes of previous meeting.
4. Reports of officers.
5. New members.
6. Reports of committees.
7. Communications, etc.
8. Unfinished business.
9. New business.
10. Nomination and election of officers.
11. Closing.

Appended are the two papers by Messrs. Showers and Beecham, above referred to.

#### The Relation of the Private Car Lines to the Railroads.

PRESENTED BY G. W. SHOWERS.

Mr. President and Members of the Car Foremen's Association:

This is a subject too vast in all its details to be compassed by the mind of one man, therefore I shall not attempt to do more than briefly refer to the origin of private car lines, their general development, the peculiarities to their growth, the classification of ownership, and finally the service which these private car lines have rendered to the railroads of North America.

Incidentally I wish to say (and you will pardon the digression) that this subject was assigned to me without any suggestion from me, and as a matter of fact much against my will, but I presume the observations of the members of this association are very much of the nature of my observations; that is to say, where all interests aspire to attain an acknowledged, desired result, and differ only in detail as to the best method of procedure for accomplishing that result, free interchange of thought, candid discussion, and calm deliberation in conference, together are the surest means of uniting in a common conclusion.

If each member of this association was so fortunate, or perhaps so unfortunate as to possess the experience of all the other members with relation to the maintenance and handling of equipment, repair forces, etc., it is not likely that this association would be in existence. It is my impression that we have not all had the same conditions to cope with, therefore, our experiences are not identical, but if we would profit by the experiences of others, then we should have, as before stated, a free interchange of thought, candid discussion, and deliberations and this method of procedure ought not to be weakened or impaired within this association, notwithstanding that our membership comprises those who are engaged with railroad companies as well as those who are engaged with private car lines, the latter companies being the subject of this paper.

It is scarcely necessary to state that the private car lines date their origin back to the early days when some of the then powerful roads foresaw the possibility as well as the advisability of creating through lines between principal cities, the creation of those through lines being by consolidation, contract or otherwise. Perhaps it is known to many of you that a railroad one hundred miles in length during the early days to which I refer was regarded as a wonderful railroad system. One of the first obstacles attending the formation of these through lines was the fact that in the original construction of railroads in this country there was no particular system or fixed rules which could be observed, particularly with relation to gauge. The old English gauge of four feet eight and one-half inches had scarcely been in use for a time sufficient to establish its practical uses so that the American builders floundered around establishing gauges all the way from four feet six to six feet, and it was no uncommon thing to find in the course of consolidation that one piece of road was of one gauge, perhaps four feet eight, while the next piece of railroad would be a six foot gauge, a third piece perhaps a five foot gauge. At one time it was found necessary by the various states in which railroads had been constructed to establish a certain gauge by law. In the majority of the Eastern and Middle Western States the gauge was placed by law at four feet ten. Following closely on the consolidation of short lines came almost generally the adoption of the new standard gauge four feet eight and one-half inches, but for a long time railroads south of the Ohio river maintained the old broad gauge.

With the formation of the through lines came the freight forwarding companies, which was a leasing by private individuals of the privilege of soliciting, forwarding and delivering of all kinds of freight in a manner very much as the express companies now handle the express business on railroads. The freight forwarding companies found it necessary to construct and maintain their own equipment so as to avoid the breaking of bulk or transfer which had been the custom when loaded into railroad companies' cars, one road being averse to allowing its equipment to go out of its possession onto the road of its connection. The cars of these forwarding companies were designed to possess all the advantages known to the handling of freight, and, as a matter of fact, were in advance of the equipment of railroad companies in that they were more commodious, were equipped with all improve-

ments known to car building, and were fitted with wheels and trucks making it possible for their safe passage over roads of the standard gauge as well as over roads with some gauges varying from the standard. In the course of time some of the principal roads deemed it advisable to construct cars which they were willing might leave their own rails, thus avoiding the evils attending the transfer of freight at terminal points, and these cars were fitted with trucks adjusted to the narrow or standard gauge, and were fitted with wheels sufficiently wide to run upon the wider gauge; these were called broad tread wheels, and the cars were "compromise." The roads owning these "compromise" cars created their own through lines, each road putting into a through line of cars a number of cars in proportion to each railroad's mileage. This through line was given a name, and out of combinations of this character grew the fast freight lines, which even to this day are in existence.

With the constant development of the country, the growth of commercial industries, the opening up of new fields of commerce, and the building up of large centers of business, together with the competition and rivalry as between the various railroads as well as with combinations in the commercial field, came the private cars of large private corporations and shippers, which cars are otherwise known as shippers' cars. A tank car may be taken as the first example. Oil shippers in order that they might market their product with the least possible expense evolved the tank car, thus doing away with cooerage of all kinds, reducing the wastage to a minimum, and putting aside the necessity for the maintenance of the old time oil house, a dangerous institution in any community. Powder cars are another example of the private line or shippers' car. The growth of large cities and the abolition of chickens and cows therein created the necessity for cars adapted to the carrying of dairy products. The success attending the use of these dairy cars suggested to packers the possibility of moving packing house products for long distances in cars, which these packers conceived should be on the theory of dairy cars, and after some tests it developed that packing house products might be marketed by means of refrigerator cars at a point hundreds of miles from the packing house in as good, if not a better, condition as if slaughtering had been done within the city's own market. Tests made by growers of fruits and vegetables developed that these commodities when handled in refrigerator cars could be marketed hundreds of miles from the place of growth in better condition and as readily as if taken into their town market in the condition in which they were loaded into refrigerator cars. The shippers of wagons and furniture, classes of freight which it had been customary to crate, and which when crated and loaded into an ordinary car, prevented the loading of more than a few thousand pounds while the capacity of the car might be as high as twenty to thirty tons, the rules of railroads being to charge carload rates for the capacity of the car, this, in fact, resulting in the loading into a car of about one-half the car's capacity, but the charge of freight rates on the basis of the capacity of the car—these shippers saw the necessity of having cars which could be loaded with furniture and wagons to the full capacity of the car. Aside from the freight forwarding lines, and fast freight lines, it will be seen that the necessity for other kinds of cars, to which I have referred, originated with shippers of particular kinds of freight, those shippers being the owners of their equipment. Of course, if all shippers were in a position to own their own equipment of the kind already referred to, no particular advantage would accrue to any particular shipper as against another shipper of like commodities, but it can be readily understood that as all shippers could not provide their own equipment, the owners of the equipment had great advantages over those who did not or could not own their own equipment.

These conditions naturally led to the formation of private car companies, each private car company furnishing a particular line of equipment for the use of those shippers less fortunate than the competitors who were proprietors of cars needed for a particular trade. It will be seen, therefore, that thus far there is a distinction and a difference between the owners of private car lines; that is to say, there is the private car owner with an equipment used exclusively in the private car owner's particular business, and there is a private car owner whose equipment is used by those shippers who are unable, or deem it inadvisable, to provide their own equipment. There are further conditions in this connection that will be noticed later.

The private stock car lines owe their existence perhaps more to the passage in 1873 of an Act of Congress, prohibiting the continuous carrying of cattle without feeding and watering for a time in excess of 28 hours. Shippers of cattle generally felt that while they might leave a market or the range for a particular market, making due allowance for running time and the unloading and watering and feeding of their cattle each 28 hours, that the conditions attending the transportation, feeding, etc., were so great in number as to almost invariably upset plans to reach the objective market at an early hour.

The virtue of palace cars which would enable cattle to be hauled uninterruptedly through to market, feeding and watering enroute, was foreseen, and the palace or stable cars came into almost general use. Of course there are other circumstances beside the Congressional Act referred to attending the bringing into existence of the palace stock cars; for instance on a great many railroads the cattle business continued for limited periods, yet the movement during a period would be so great that if sufficient cars were owned by the originating road to enable that road to move all the cattle within reasonable time, the number of cattle cars necessary would be so great after paying the interest on the investment in the cars, there would be little, if any, return from the movement of the cattle, the fact being that if a thousand cars were needed to move cattle tendered for shipment, within one month, and if the originating road owned a thousand cars, those cars would be employed for a month in each year, and be unemployed for the remaining eleven months. It might be said that the originating road could receive from its connections such cars as it might require for the period of a month, but more than likely its connections would be in the same predicament. It might be said that the originating road could receive a supply of stock cars from its connections leading into the great cattle markets of this country, viz.: Kansas City, Omaha, St. Louis, Chicago and the east, and the argument might be presented that roads leading into those large markets are always well provided with stock cars for which they have use throughout the entire year, which argument cannot be justified because, as a matter of fact, all of the railroads, even in this section of the country, are obliged regularly during some period of the year, to seek relief from the private stock car companies, and it has not infrequently occurred that at the very time when railroads in the middle states have been taxed to their utmost to spread their own equipment out sufficiently to care for their own cattle business, that at that very period the lines in the range country were clamoring for cars to move the range cattle. Certainly, the range cattle roads or the roads in the middle states or both classes of roads, must suffer if all those roads must rely for their supply of stable cars on the cars owned only by the railroads. It has often been said that if the range railroads owned their own stable car equipment that though it could be used by those range roads for a short period each year there would always be an opportunity to loan the cars to roads originating cattle business during remaining periods. The fallacy of this can be readily seen, for example: the cattle business on this continent has its seasons as regularly as the seasons of the year. During a short period in the early part of the year cattle moved from the Gulf territory of Texas and east and west in that parallel north to the pastures of the Indian Territory and Kansas. Following that period the beef cattle move past the grazing cattle to the slaughtering markets; later the grazing cattle from the territories, and from grazing sections move to the slaughtering markets. This is followed by a movement of western cattle, and by the time the snow flies, the cattle raisers of the great northwest have about cleaned up their ranges for the year, and yet during these periods there is a constant movement of native cattle to all the slaughtering markets requiring very nearly the entire equipment of roads engaged in the carrying of native cattle.

For any discussion that may grow out of this paper, nothing to my thinking can be of greater interest than the subject of the private stock lines, and as to this particular class of equipment I submit that they furnish stable cars for all those roads that find it unnecessary or unwise to own a maximum number of cars for the maximum movement of business gauged by the high mark movement of previous years or by the flowery prospects usually communicated by the hustling live-stock representative in the field. This class of cars makes it possible for railroad companies to move a maximum number of cars over a division or a road in the minimum time, preventing shrinkages of cattle so common with the old classes of cars. Right here, it is well to suggest that as railroad companies collect their freight charges based on the weight of cattle at the terminal station, it follows that the greater weight of the cattle, the greater the amount of freight charges collected. These stable cars have been instrumental in abolishing delays, inconveniences, causes for damages to cattle and all other evils incidental to the unloading at feeding stations. They have made it possible to handle the increasing range business with a lesser number of cars than were required ordinarily when cattle were unloaded every 28 hours, because a stable car made it possible to move cattle continuously without interruption from a point of loading to the market.

To make this proposition clearer, with the use of the ordinary stock car they were usually side-tracked at a feeding station for the length of time the cattle were feeding; usually from six to ten, or sometimes 24 hours. With a stable car this side-tracking process is abandoned generally. Of course, the fact that stable cars were (if I remember correctly) originally equipped with air and automatic couplers, may not

now be considered of sufficient credit, but it is worthy of mention that these stable cars were equipped with all improvements necessary for the transportation of stock trains with a safety and rapidity equal to the movement of passenger trains, and to this day those cars, in order that their operations be satisfactory to their owners, must be maintained at the highest degree of standard irrespective of the rules of the Master Car Builders' Association or the local requirements of railroads; they must be in a condition to pass inspections encountered in every section of the United States, Canada and Mexico.

What I have thus far said may furnish considerable food for reflection, but I would not consider that I had done justice to this association or myself in the presentation of a paper if I did not make it clear that there are various kinds of private car lines:—the fast freight line whose ownership is confined to railroad companies; the private car lines owned by large shippers; the private car lines owned by capital outside of shippers, the object of this class of private car lines being to furnish smaller shippers with an equipment which those shippers are unable to own themselves, the use of which equipment places the small shipper on a parity with the shipper owning his own equipment; the private car line with an equipment not intended for the use of any particular shipper (large or small) but for the purpose of supplying railroads with classes of equipment which the railroad deem it unwise or are unable to own, or which the railroads feel that it would be unnecessary to own because of the likelihood that they (the railroads) would not be able to keep actively engaged for even a reasonable period of each year. When a railroad owns its own equipment it represents capital, and interest must be paid. When a railroad uses a private car company's car, it pays for it for the time during which it is used and is not concerned in the amount of capital invested or the interest to be paid on the investment. When the railroad has no use for a private car, it is sent home, and the private car owner is obliged to find another source for the use of his cars. That the private lines generally have rendered invaluable services to railroads goes without question. If the product of oil wells was handled today as it was thirty years ago (in barrels, cans, etc.) who will say it would be possible to substitute oil for coal for producing steam, or how would it have been possible even to market the residuum of an oil tank hundreds of miles from an oil well; what would be the price of oil for illuminating and for lubrication? The tank car has made it possible to reduce the price of oil products to that point where they are within the reach of all persons in all parts of the country for all purposes, at the same time more than doubling the number of men engaged in the oil business.

The refrigerator car has developed the fruit and vegetable business to an extent which admits of no comparison at the time when the refrigerator car was an unheard of element in railroad equipment; it has worked wonders in the dairy line, and has made the packing business one of the foremost institutions of the country. It would seem that a nation of workmen are engaged in that particular business within the confines of the Union Stock Yards of this city, to say nothing of the workmen engaged in like institutions in nearly all of the large cities in this country. I am told that the refrigerated products of our packing houses can be found in nearly every civilized section of the globe. The palace stock car has been an able ally in the building up of the packing house business; it has done nearly as much as railroads in building up and civilizing the frontier sections of the country by enabling cattle raisers to move to cheaper lands more distant from markets, the increased distance being reduced by the decreased time in reaching markets. A practical example of this combination can be seen throughout Texas, Kansas, Nebraska and the Dakotas, where farmers are tilling soil used only a few years ago by cattle raisers.

Private car companies are not what they seem to be; they are, in my opinion, what I have shown them to be, and while I have in my career had occasion to listen to arguments, pro and con, on the subject of private car lines, usually feeling that they rightfully had no place in the railroad world, and were entitled to no special consideration, I am now satisfied and state it from a purely unbiased standpoint, that in putting together the matter contained in this paper, I have never ceased to think that private car lines have performed a wonderful work, and are entitled to one of the first places in the railroad creation.

It is not my purpose to even suggest that there is any feeling of opposition on the part of any member of this association to private car lines generally. My observations have been that the private lines are treated with a marked consideration; not any greater than they are entitled to, but if there should happen to be just a spark of opposition lurking within the minds of any of the railroad representatives present here today, either against the private car line, or the perpetrator of this paper, I respectfully request that they think it over and forgive.

## The Work of the Car Foremen's Association— Accomplished Results.

PRESENTED BY W. E. BEECHAM.

Mr. President and Gentlemen of the Car Foremen's Association:

I presume it is not generally known that I was present at the inception of this association. A few gentlemen assembled in the Old Colony building several months ago, at my suggestion, but I did not know at that time, of course, what it was likely to come to, and when I promised the secretary that I would say a few words to you this evening, I was under the impression that it would be a small gathering I would have to talk to. I am very much pleased and highly gratified to see how this association has grown. I, of course, take a personal interest in it having myself, with a few others, originated it, and I am more than pleased to see it has attained such proportions as I now see it has.

Mr. Miller, president of the Chicago, Milwaukee & St. Paul Railway, says that the object for which a railway exists is to obtain freight and passenger traffic at remunerative rates, and to transport it with economy and despatch. To obtain such results the several departments have been created, and are mutually dependent. I do not know that any two departments are more dependent upon each other than the transportation department and the car department.

It is the province of the car department to see that the equipment is in a safe and serviceable condition, and that of the transportation department to employ it economically and profitably.

The transportation department will not trespass upon the domain of the car department for the reason that it would not be safe to do so. We are not supposed to know whether the equipment is fit to use or not until you gentlemen tell us so; and if you say that it is not in a safe and serviceable condition, we cannot use it. It must stand upon the side-tracks, or upon the repair tracks until you tell us we may use it. Now then, gentlemen, under those circumstances you will see how dependent we are upon you. Unless we have your active and earnest co-operation, we cannot do anything; we cannot carry out the very purpose for which a railway company exists, because we have nothing to work with. Without the active co-operation of the car department the transportation department might as well "hang up its fiddle," because it can do nothing.

It is one of the great essentials in the organization of a railway company, large or small, that good discipline should prevail, and that there should be harmony throughout the entire system. Not only that, but we should endeavor at all times to maintain the most harmonious and friendly relations with all our connections, especially so in a large terminal like this, where the inspection points are so widely separated and where communication is sometimes difficult, making us all more or less dependent one upon the other, for assistance in keeping the equipment on the move.

The Master Car Builders' rule which says "foreign cars shall receive the same care as our own," should be very liberally construed, and you should aid one another as much as you possibly can in quickly disposing of such cases as come before you for decision wherein the condition of equipment is in question. We should not be allowed to remain any longer than is absolutely necessary pending decision of any case. Whatever is to be done should under all circumstances be done as quickly as it is possible to do it in order that the equipment may be released to the transportation department for them to employ to the best advantage. If this idea is carried out entirely, it will enable railway companies to accomplish the purpose for which they were created; the handling of traffic with economy and despatch and profitability. That is what they are after—they want to make money.

The conditions in this country have changed very materially within my recollection. It was possible at one time for a young man to start out, it did not matter much what business he went into, and there was a chance for success, and he did not have to have a great amount of ability, either. Railway companies, as well as all other business interests, were looking for men; of course they were looking for the best that they could get, but the struggle in these days was not so keen. Railway companies were building new lines at all times and they had to have men to fill the various positions that were constantly opening up. Telegraph operators in those days easily commanded a salary of one hundred dollars a month, and other positions were in the same proportion. But in this day it is a little different. Railway companies are not extending their lines to any great extent; they are not creating new departments. The country has been pretty well subdued, and now they look around and try to get the very best men they can to fill their various positions. And for that reason the more useful a man makes himself, the more likely he is to succeed in whatever branch of the service he is engaged in.

As between the transportation department and the car department, there can, of course, be no conflict of authority. Their duties are so well defined that it would be almost impossible for one to trespass upon the other. But while that is undoubtedly true, it is also a fact that the employes of those two departments, if they

work in harmony, will be able to very materially assist each other, and of course in doing that they are promoting the welfare of the roads by whom they are employed.

It often happens, or has often come to my notice, that there is a disposition on the part of some people to take care of themselves first, that is to say, we will take care of our own cars first, and then, if we have time, we will take care of others. But that is not a good way to look at it: that is a selfish way. We should remember that if they all do that, the result, of course, will be that a certain proportion of the equipment of the country is bound to be neglected, and while we may suffer this time, somebody else will suffer some other time, and that these disadvantages will even themselves up in time.

Settlements for cars that are often destroyed are frequently delayed an unreasonable time by the car department. We like to get such matters as that wiped off our books; we like to have you gentlemen of the car department decide as promptly as you possibly can what disposition you will make of these wrecks. The Master Car Builders' rules define the matter very thoroughly, and there is no occasion for much delay. All you have to do is to simply get at the facts, and say whether you will pay or whether you will rebuild. But sometimes those settlements drag along into months. All that time the car service department is keeping the books open awaiting your decision. In like manner it very often happens that a car will remain on the side track while a question of slight repairs is brought up. That is all wrong. Before the adoption of the new rule of interchange we used to have a great deal of difficulty in this terminal in the unnecessary rehandling of cars on account of their being in bad order. But since the adoption of the new rules of interchange there has been very little difficulty on that score, and since the formation of this association I notice that, as far as my experience goes, we have not had occasion to complain that the transportation department was put to any unnecessary expense because the car department did not tell them what to do. These matters seem to have been thoroughly solved by your association, and by the Master Car Builders' Association, so that now we are not vexed by such matters at all. In fact it is almost impossible for anyone to estimate the saving that has resulted by the adoption of those rules, and by the united action of the car departments of the various roads that center in this city. I believe that it has been very great. I know it has. We used to be continually investigating these matters, but within the past year or two we have had no occasion whatever to do so. In fact I have no recollection of any case of that kind having come to my notice within a year or two, and I attribute these beneficial results to the united action of the various car departments of the lines in this city.

I regret exceedingly, gentlemen, that I did not come prepared to go into this matter more fully, and I will not take up your time any further. I thank you for your attention.

Referring to the duty to give adequate instructions to employes the supreme court of Pennsylvania declares that it is untenable to contend in an action brought to recover damages for personal injuries, that if there was any negligence in omitting to give proper instructions, it was the negligence of a fellow servant, etc. If such contention could be maintained, no corporation could ever be liable for negligence in that regard. Continuing, the court says (Smith against Hillside Coal & Iron Company, May, 1898), that a master's duty to give adequate instructions to such of his employes as from age, inexperience, or other cause, are ignorant of the dangers of their employment, etc., is similar in its nature to that required in the employment of competent fellow workmen, and furnishing safe machinery, etc. These are all duties which the master owes to his servants, and from which he can relieve himself only by performance.

**NOVEL SPARK ARRESTER ON THE NORTHERN PACIFIC RAILWAY.**

In our issue of May, 1898, page 60, we gave drawings and descriptions of the curious spark arrester used on the Northern Pacific Railway on sections where lignite coal is employed. We are now enabled to present a reproduction of a photograph of an engine equipped with this device. It makes an odd looking engine, but one which does not appear so awkward as the drawing would lead one to expect. Despite its ugliness "it does the business" very completely. It constitutes a complete arrester of all fire sparks from the lightest of coal, requires no netting, is economical in fuel, necessitates no dumping or clearing of cinders and is simple in construction and durable in service. Quoting in part from our previous description we may state that the device consists essentially of an exhaust pipe made

in the form of a reverse curve which shoots the products of combustion from the front of the smoke box through a petticoat pipe which is so placed as to gather all the contents of the box freely and to pass them through a convex pipe attachment to a spark chamber located on the top of the boiler. This spark chamber contains a dash plate which thoroughly scatters the sparks, all of which are ex-

tinguished by contact with the exhaust. The light, extinguished, sparks pass out through the stack. The heavier sparks fall to the bottom of the chamber and are carried thence back to the firebox by means of steam jet pipes.



NOVEL SPARK ARRESTER—NORTHERN PACIFIC RAILWAY.

tinguished by contact with the exhaust. The light, extinguished, sparks pass out through the stack. The heavier sparks fall to the bottom of the chamber and are carried thence back to the firebox by means of steam jet pipes.

**ATMOSPHERIC RESISTANCE TO THE MOTION OF RAILWAY TRAINS.**

In our issue of June we gave the substance of the conclusions reached by Prof. W. F. M. Goss, after a series of experiments to determine some laws governing atmospheric resistance to the motion of railway trains. At that time we stated that we would at earliest opportunity give some account of the apparatus employed and the conditions under which it was operated. We now do so, our material being abstracted from Prof. Goss' paper before the Western Railway Club.

The resistance which must be overcome by a moving train arises from several causes; as, for example, from the rolling friction of wheel on rail, the effect of gradients and curvatures in the track, the necessity of producing accelerations in the speed, the friction of journals, and from the resistance of the atmosphere.

The work which must be done to overcome the effect of grades and to produce accelerations in speed can be accurately determined, and the value of journal and rolling friction, when considered apart from complicating conditions, is already somewhat definitely known, but the available evidence concerning atmospheric resistance is contradictory and the result of its application uncertain. The importance, therefore, of this latter element is emphasized by the fact that it is at present the chief element of uncertainty entering into any general consideration of train resistance. It is with this element only that the present discussion is concerned.

The conditions under which the experiments were made, were assumed to be similar to those surrounding a train moving through still air, and the object of the experiments has been to disclose the value of forces resulting from the resistance offered by a quiescent atmosphere to the forward movement of trains through it. No attempt has been made to consider the effects resulting from oblique or other winds.

The plan of the experiments involved a rectangular conduit, within which a current of air having any desired velocity could be maintained. Within this conduit, and exposed to the action of the air currents, small dummy or model cars were mounted. Each model was connected by means of a sensitive dynamometer, with a suitable base so arranged as to indicate the value of any force tending to displace it in the direction of its length. A single model or any number of models placed in order, as in a train, could be employed in any given experiment, the effect of the wind upon each car being always shown by the indication of its attached dynamometer.

Conduit.—The conduit in which the flow of air was maintained for the experiments, is in the form of a rectangular tube 20 inches x 20 inches in section and 60 feet in length. A cross-section is shown by Fig. 1. The lower face is of solid wood; the upper, also of wood, is pierced at intervals of six feet by good-sized openings,

per. The interior surfaces also are unbroken from end to end, and, where of wood, are made so smooth by shellac as to offer but slight resistance to the passage of air through the tube.

Air Supply.—The conduit is connected at one end with a No. 60 Starrevant blower, the opposite end being open to the laboratory. The whole apparatus being in one room, the duty of the blower is simply that of circulating the air of the room through the tube, forcing it in at one end and allowing it to discharge at the other. The blower is of sufficient power to produce air currents in the conduit having a velocity of 100 miles an hour.

The Determination of the Velocity of the Air Currents.—The velocity of the moving air within the conduit was determined by use of instruments in the form of Pitot's tubes. These were made up of two brass tubes, arranged within a larger tube or jacket, all being cemented together by resin, which filled the interior of the jacket around the smaller tubes. The interior diameter of the small tubes was a sixteenth of an inch, and the diameter of the jacket tube somewhat less than a half-inch, while the length of the combination was such as made it possible to reach from the exterior to any portion of the interior of the conduit. This portion of the apparatus is shown by Fig. 3. When in use the tip end, a, of the gage was inserted into the current through holes bored in the top planking, a cork bushing lining the hole, and making tight the joint between the wood and the gage. Each of the two small brass tubes making up a gage was then connected by rubber tubing with one side of a glass U-tube fixed to a suitable scale outside of the conduit. The U-tubes were sealed with water, from the displacement of which the velocity of the air passing the tips of the gage was determined.

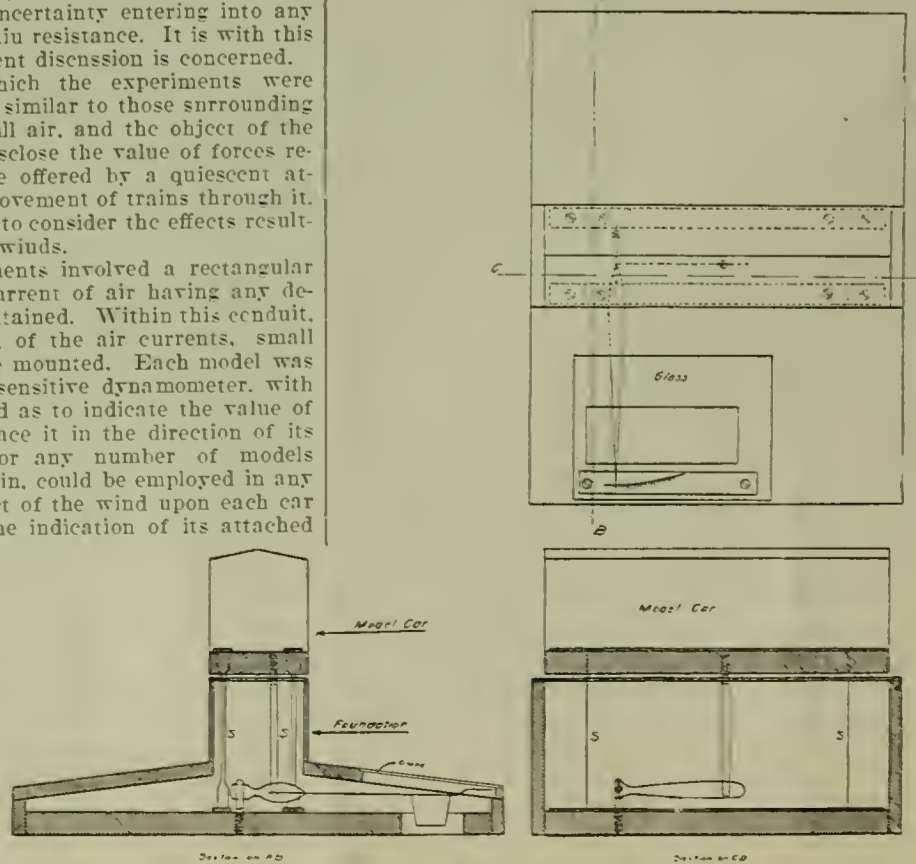
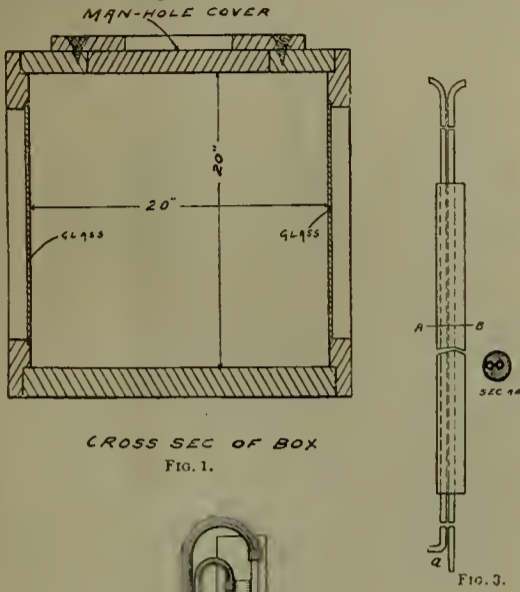

FIG. 5.

The several gages employed were subjected to a careful examination, involving a series of simultaneous observations in connection with a systematic interchange of position, to determine whether all could be depended upon to give like indications when the conditions were the same.

Another preliminary to the main investigation was that of determining the relative velocity of the stream of air at different points in the cross section of the con-



CROSS SEC OF BOX  
FIG. 1.

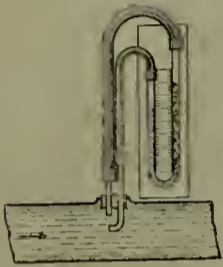

FIG. 2.

duit. This was done by dividing the cross-section into twenty-five or more imaginary squares and observing the velocities at the center of several of them at the same instant, after which some of the gages would be changed to other squares and the process repeated, the observations for each set of readings overlapping those of the preceding set as a check on the constancy of conditions. A number of typical diagrams resulting from this process are presented as Figs. 4. They show velocity of the current in miles per hour for different portions of the cross-section of the conduit.

That there might be no uncertainty, also, as to the character of the flowing current of air, the cross-section of the stream was carefully examined at many points throughout the length of the conduit, and as a result the following conclusions were reached:

1. That while considerable unevenness of flow was observed near the initial end of the conduit, the eddies disappeared at a distance of 35 feet from the initial end, and from this point to a point near the discharge end



FIG. 4.

of the conduit, the flow was found to follow lines which were approximately straight.

2. That the glass surfaces forming the sides of the conduit offered less resistance to the movement of the air than the wooden surfaces forming the top and bottom.

3. That the lowest velocities were found, as would be expected, in the corners of the conduit, that is where the sides joined with the top and bottom.

4. That there was a comparatively large vein in the interior of the stream, all portions of which flowed with practically the same velocity.

The experiments which are to be described made use of that portion of the stream which was most free from eddies and which was least influenced by the walls of the conduit.

The Model Cars.—Having obtained means for making a breeze of satisfactory quality, and for determining its velocity, the next and last step concerned the model cars which were to be exposed to its influence. To facilitate the description, these model cars will hereafter be referred to as models. These were 1-32 the size of an assumed standard box car, the body of the model extending downward and occupying the space which in an actual car intervenes between the sills and the rails. Each model was 12 1-16 inches long, 3 3/8 inches wide, and 4 1/2 inches high. Its form may be more perfectly apprehended by reference to the drawing (Fig. 5). The painted tin body of the model was fitted over a wooden base supported by four leg-pieces of light hard-rolled sheet brass (marked S on Fig. 5) which in turn were securely fastened to a suitable foundation. The length

and lightness of these legs or springs allowed the car to be displaced longitudinally, under the action of the slightest force, and they were at the same time so proportioned as to resist all tendency to motion in other directions. Between the body of the car and its foundation, also, and entirely independent of the springs already referred to was a system of levers, the purpose of which was to multiply any longitudinal displacement to which the model might be subject. These levers were made of thin metal, the several parts being soldered to each other. All motion, consequently, was within the elastic limit of the parts affected. There were no loose joints. The whole arrangement proved to be both sensitive and reliable. The least pressure upon the car would result in a movement of the pointer, and the pointer would promptly return to its zero when the force producing the displacement had ceased to act. Excessive vibrations of the pointer were prevented by a vertical fin which could be made to dip into light oil contained in a suitable pan beneath. That no part of the dynamometer might be directly affected by the currents of air acting upon the model, the mechanism was entirely enclosed in the foundation, a portion of the surface of which was of glass through which the movement of the pointer could be observed.

The degree of refinement attending the action of these dynamometer cars will be appreciated when it is said that while the actual movement of the car was always slight, an inch and a quarter movement of the pointer was readily obtained. The springs for a number of cars were made so flexible as to give an inch movement of the pointer under a force of an ounce acting upon the end of the model. Two models, however, to serve at the ends of trains were provided with much stiffer springs.

Observations.—With the desired number of models arranged as a train, which alone was used in determining velocities in the conduit, the experiments proceeded about as follows: The blower engine was started and allowed to run at a slow speed for a sufficient time to secure constancy of conditions with the conduit, after which readings were taken simultaneously from the gage, and the dynamometers of the several cars composing the train. These observations were repeated at thirty-second intervals until five readings had been taken, when the averages of the five successive readings were brought forward to a condensed log of observation. When one set of readings had been taken the speed of the blower was increased, and all observations made for the new conditions. In this manner the work was advanced with each length of train, the velocities of the air currents varying from 20 miles per hour to something over 100 miles per hour. No effort was made to obtain definite conditions of air velocity, the object being to have a constant flow, and to observe accurately what were the precise values by which the conditions were defined.

FORGING LOCOMOTIVE ROCKERS.

In the shops of the Pittsburg & Lake Erie Railroad at Pittsburg, Pa., there is employed an ingenious method of forging locomotive rockers. The methods and tools employed were designed by Mr. A. W. McCaslin. The purpose in mind, in designing these tools, was the forging of locomotive rockers without a weld or a bend. This plan has been employed in the shops of the railroad named for three years under an 1100-lb. hammer and has proved itself to be a decided success in the way of avoiding welds, lessening labor and reducing the cost of rockers made by any other method.

The bore (see 1, fig. 2) is 9 in. long and has a diam-

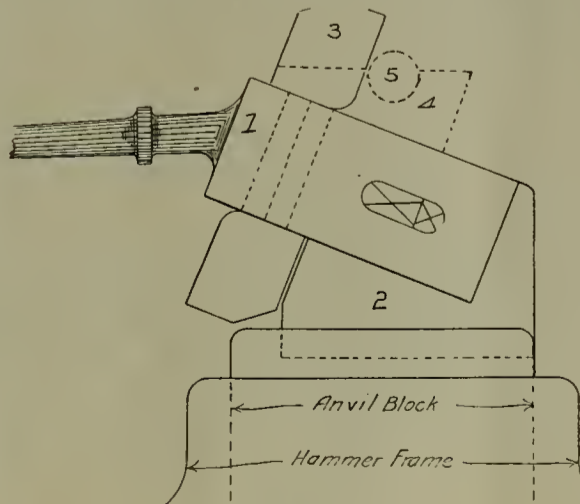

FIG. 1.

eter of 4 3/8 in., being faced off to tighten on 3 3/8 in. diameter, thus adapting it to use for any size of rocker. The iron used is 8x5 in. The barrel of the rocker is rounded and the stub, 3, (fig. 1), is heated and then driven down to the position, 4, shown in Fig. 1 by dotted lines. A fuller is then used, at 5, and then the tapered tool No. 6 (fig. 2), which leaves

the arm square with the barrel. The boss is then heated and the annular tool (see bottom of fig. 2) is used to trim off the surplus from the sides of the arms. One great advantage with this method is that it permits of placing the work at an angle, admitting of its being used under a small steam hammer.

We understand that there is a saving of about 50 per cent in making rockers by this method by reason of doing away with the sledging or hand labor:

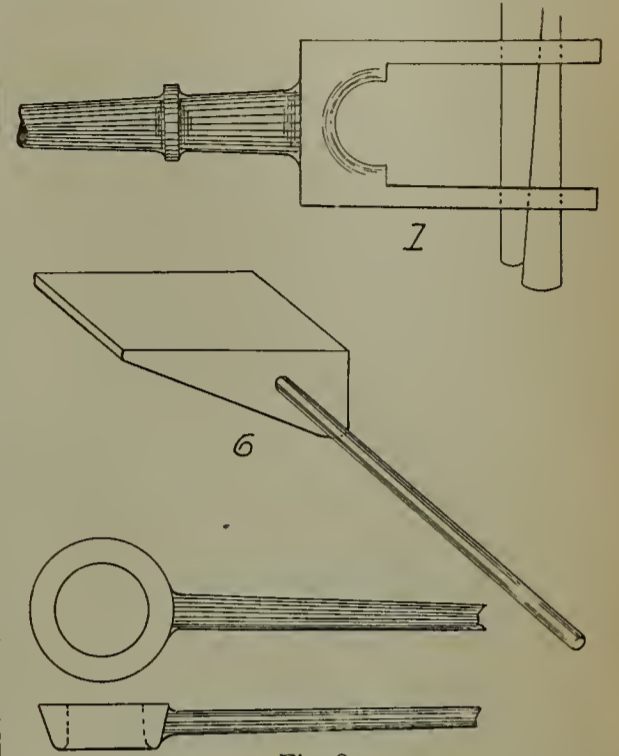
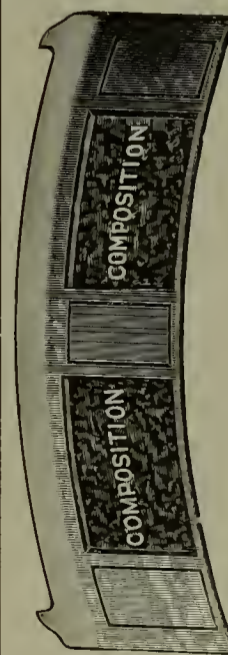

FIG. 2.

but the main advantage claimed is that the rockers are made without a weld or a bend under a small hammer. The practice frequently seen is to either weld the arms on or to forge the rockers solid and bend them with sledges. A good weld is not always surely at command and even if so it involves hand work; and on the other hand bending the arms draws or pulls the iron on the outside and crowds it on the inside of the bend. By use of the angle tool shown these difficulties are largely eliminated.

ALLEN-MORRISON COMPOSITION BRAKE SHOE FOR STEAM ROADS.

In our issue of June, 1898, we gave a description of the Allen-Morrison brake shoe as designed for elevated and street cars. We



show now a view of the same shoe adapted especially for steam road work. The same composition is used, but the form of the shell is varied. Three chilled pieces are employed as shown, the chills reaching to within 1/4 inch of the outside of the shoe. The shell is poured around the chills, and the composition is afterwards pressed in. Tests made with this shoe prove, it is claimed, that a train can be stopped in about two-thirds of the distance that they usually stop with the iron shoe. A full set of shoes for a train and locomotive have been shipped east to be put on the B. & O. express between Baltimore and Washington, and a full set is now being put on one of the Santa Fe trains. A considerably longer life for this shoe is claimed over that of any soft iron shoe, as well as a much greater braking power than with the ordinary chilled shoe. This shoe is offered by the Allen & Morrison Brake Shoe Manufacturing Company, 504 Fisher Bldg., Chicago.

Early in June the Cincinnati, Hamilton & Dayton made its first actual schedule with its new motor car against the Traction Company. The schedule is slightly quicker than that made by the electric, the run being between Middletown and Hamilton, a distance of fourteen and a half miles. The railway has

adopted Traction Company's rates. The results so far are very much better than expected. It feels quite confident that with the motor car making frequent stops and giving frequent service at the Traction Company's rates, and with its steam trains at the regular rates, and fast time, that it has the situation pretty well in hand and that any attempts to compete with it for long distances by electric lines will prove a very unprofitable investment.

PROTECTION OF STEAM-HEATED SURFACES\*

BY C. L. NORTON

The investigation, of which this is a partial report, has been pursued during a large part of the years 1896 and 1897, and is yet uncompleted. The method adopted is one which, so far as I know, is original. A piece of steam pipe is heated from the inside electrically. The amount of electrical energy supplied is measured, and hence the amount of heat furnished is known. If the steam pipe is kept at a constant temperature by a given amount of heat it is because that amount is just equal to the heat it is losing, for if the supply were not equal to the loss, the temperature would rise or fall.

The apparatus for making tests by this method comprises several pieces of steam pipe of different diameters and lengths, heated electrically from within by means of coils of wire in oil. A section is shown in Fig. 1. A piece of 4-in. steam pipe, 18 in. long, is closed at one end by a plate welded in, and at the other by a tightly fitting cover. This pipe is then filled with cylinder oil, and a coil of wire of sufficient carrying capacity and a stirrer are introduced into the oil. A thermometer is inserted in such a position as to record the temperature of the oil. An ammeter and voltmeter, or a watt-

TABLE I.

Table with 6 columns: SPECIMEN, Name, B. T. U. Loss per Sq. Ft. Pipe Sur. per Min., Ratio of Loss to Loss from Bare Pipe, Thickness in inches, Weight in Ounces per Ft. of Length 4 In. Diam.

meter may then be connected so as to record the amount of electrical energy supplied. It is my custom to suspend the apparatus in the middle of the room on non-conducting cords, and read the thermometer with a telescope, so that no heat from the person of the observer may be added to the supply given to the cover from within, and also that care may be taken not to produce air currents by walking near the apparatus during a test

In making a test the current is turned on, and heat is generated in the wire coil until the wire, oil and steam pipe have reached the desired temperature at which it is proposed to test. The current is then gradually diminished until it is found to be of just the amount necessary to keep the pipe at this temperature without a rise or fall of 1-10 of a degree in 30 minutes. A reading of the voltage and current is now taken at intervals of 30 seconds, and the watts and B. T. U. are computed from their average. We then have the number of B. T. U. lost from the outside of this particular pipe at this particular temperature. If now we place a steam pipe cover around the pipe, we shall find that a less amount of energy is sufficient to keep it at the required temperature, the difference being the amount of heat saved by the covering. The minimum length of time considered sufficient for the equalization of heat, or "soaking in" to the cover is six hours. It after a second heating of six hours no change in the conducting power is noted, the cover is considered in a permanent condition and is tested.

Table I. gives the relative conductivity of the various kinds of steam pipe cover tested up to April, 1898. It gives the results of the tests upon most of the samples tested, some being omitted when found to be of such low efficiency as to be of doubtful value.

The conditions of testing were such as I have adopted as being reasonably near the conditions of actual practice. The room temperature was kept at 72 degrees Fahrenheit, and the openings into the room were carefully closed. Two specimens of each make were tested, and in some cases, four, the mean value being given in the table.

\*From a paper presented at the June, 1898, meeting of the American Society of Mechanical Engineers.

Table II. gives the saving, in dollars, due to the use of the various covers

Table III. shows that at the end of ten years the best of the covers tested will have saved \$46 more

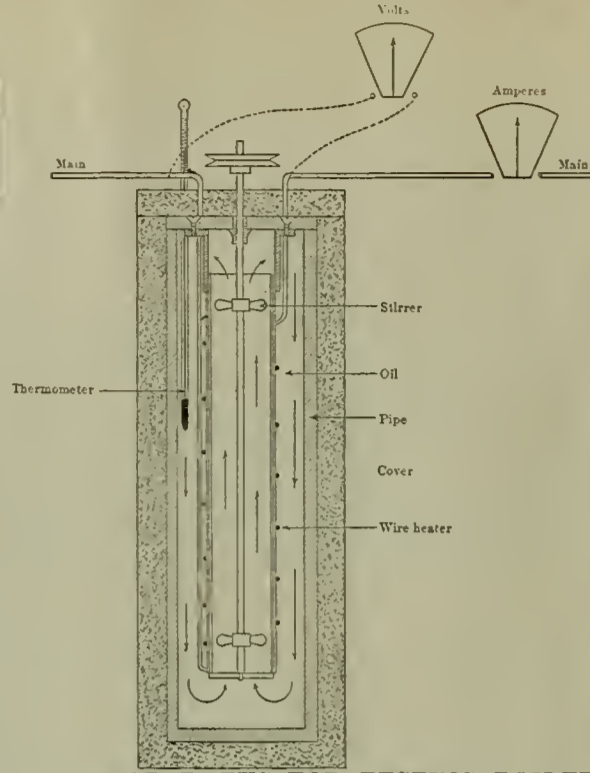

FIG. 1.—APPARATUS FOR TESTING BOILER COVERING.

than the poorest. The difference between the several covers of the better grade is exceedingly small. The money saving is computed on the following assumptions. Coal at \$4 a ton evaporates ten pounds of water per pound of coal. The pipes are kept hot ten hours a day three hundred and ten days a year. Generally speaking a cover saves heat enough to pay for itself in a little less than a year, at 310 ten-hour days, and in about four months at 365 twenty-four-hour days.

It is evident that the decision as to the choice of cover must come from other considerations, as well as from the conductivity. The question of the ability of a pipe cover to withstand the action of heat for a prolonged period without being destroyed or rendered less efficient is of vital importance. The increasing use of cork as an insulator has led to many questions as to its ability to remain "fire proof." I have exposed it to a temperature corresponding to 350 pounds of steam for three months, and to a temperature corresponding to 100 pounds for two years, and can detect no change, and I am satisfied, as well as one can be without the actual experience, that any suspicion of its ability to

TABLE II.

Table with 4 columns: Specimen, Name, Loss B T U (240 lbs), Saving B T U, Saving per year per 100 sq. ft.

TABLE III. NET SAVING PER 100 SQ. FT.

Table with 5 columns: SPECIMEN, NAME, 1 YEAR, 2 YEARS, 5 YEARS, 10 YEARS.

withstand continued heating is groundless.

The magnesia covering is, of course, unquestionable on this ground, being almost indestructible by heating. The Imperial asbestos is also perfectly safe from any fire risks, as is the Air-Cell and Fire Board. The Manville and Marsden Infusorial Earth, and also the Manville Asbestos-magnesia are liable to no accident from fire, nor is the Carey Calcite.

The following assumptions have been made in computing tables III. and IV. First, that all the covers cost \$25 per one hundred square feet applied. Secondly, by the advice of the makers, I have made an assumption that the cost is not nearly proportional to the thickness.

Inspection of table IV. shows the saving due to the use of hair felt outside a standard magnesia cover. In five years 100 square feet of hair felt saves \$7 more than its cost, and in ten years it saves \$20 above its cost. The further saving due to a second inch outside

TABLE IV. VARIATIONS IN THICKNESS, ETC.

Table with 6 columns: Specimen, Saving in B. T. U. per sq. ft. per minute, Saving in dollars per 100 sq. ft. per year, NET SAVING (1 year, 2 years, 5 years, 10 years), Approx. life cost.

the first is \$8 in ten years. Of course the well-known tendency of hair felt to deteriorate should be considered.

In the case of Nonpareil Cork, increasing the thickness from one to two inches raises the cost from about \$25 to \$35 per 100 square feet, and increases the net saving in five years by \$10 and by \$30 in ten years. In other words, the second inch of material in use about pays for itself in two years, while the first pays for itself in about one year. The third inch does not increase the saving even in ten years. In general it may be said, therefore, that if five years is the length of life of a cover, one inch is the most economical thickness, while a cover which has a life of ten years may to advantage be made two inches thick.

A very thorough test was made of the common method of judging a pipe cover by the sensation of warmth given the hand on touching it, and nothing too harsh can be said of this practice. The sensation is dependent to such an extent upon the nature of the surface that it fails utterly to give any idea of the actual temperature. I have been unable to devise any method of so attaching a mercury thermometer to the outside of a steam-pipe cover as to make use of it as a testing device in measuring heat loss.

I am now testing a considerable number of samples

TABLE V. MISCELLANEOUS SUBSTANCES.

Table with 3 columns: Specimen, B. T. U. per sq. ft. Saving in one year per min. at 240 lbs. per 100 sq. ft. pipe.

of non-conducting material, not perhaps classed as pipe covers, but used for heat insulation. Table V. gives some figures concerning them which may be of interest.

The box A referred to in the table is a 7/8-in. pine box, large enough to surround the pipe, and leave a 1-in. minimum space at its four sides. In it were tested several materials which I find are used in just this way for steam and cold storage insulation.

WHAT IS THE HEATING SURFACE OF A STEAM BOILER?\*

BY CHARLES WHITING BAKER.

It is a fact which is now generally understood by engineers and all who have to do with steam power plants, that the power of any boiler, or more accurately the amount of steam which it can furnish in a given time, depends first of all upon its area of heating surface. But we have to notice the remarkable fact that in computing boiler heating surface, an error of from 7 to 17 per cent is made by a large proportion of steam engineers and boiler manufacturers. The error to which we refer consists in taking the surface in contact with the water, instead of that exposed to the fire or hot gases, as the heating surface. The error arises in the first place from a failure to appreciate the fact that the

\*From a paper presented at the June, 1898, meeting of the American Society of Mechanical Engineers.

heating surface exposed to the fire is the actual heating surface of the boiler, on which its capacity depends.

Experiments on the conductivity of metals have shown that an iron plate 1 ft. square and 1 in. thick whose opposite surfaces are kept at a uniform difference in temperature of 1 degree Fahr. will transmit in an hour 473 British thermal units. Hence to transmit 2900 British thermal units per hour, the difference in temperature of the two sides of the plate will be  $2900 \div 473 = 6.13$  degrees. The shell heating surface in internally fired boilers is seldom over  $\frac{5}{8}$ -in. thick. Furnaces and fire boxes are made of  $\frac{1}{4}$ -in. to  $\frac{3}{8}$ -in. plates, while tube heating surface is from 1-16 to  $\frac{1}{8}$ -in. thick. We see then that the actual difference of temperature between the two surfaces of a boiler tube transmitting heat at the rate already named will be from  $\frac{1}{8}$  to 1-16 of 6.13 degrees, or in round numbers from  $\frac{3}{8}$  degrees to less than 1 degree Fahr. As the eminent physicist Lord Kelvin has said, for all practical purposes we may consider that the heating surfaces of steam boilers conduct heat as if they were no thicker than paper, or as if the metal were of infinite conductivity.

There are many facts of practical importance to be drawn from this. For example, in its light we can readily see how little reason there is to expect any greater economy in locomotive boilers with brass or copper tubes and fire boxes than in those of steel. Yet we still hear the superior conductivity of copper urged as a reason why English railways stick to the use of copper fire boxes.

Experiments have been conducted to determine the temperatures to which a metal plate could be heated when one side was in contact with water. The temperature was determined by inserting in it plugs of various fusible alloys, and the fire side of the plate was then subjected to the most intense heat that a powerful blow-pipe could produce. So long as the water side of the plate was clean, it was impossible to melt the fusible plugs. In any steam boiler with clean heating surfaces we can assume the temperature of the fire side of the heating surface to be practically the same as that of the water in the boiler. Perhaps it may be 1 degree more; perhaps it may in some cases be 20 degrees, or possibly 30 degrees, more. The difference is of no practical importance, since in the few cases where so large a difference as 20 degrees or 30 degrees may possibly exist, the temperature of the fire to which the surface is exposed is greater by probably 2000 degrees or more than the temperature of the plate.

The area of the fire side of the tube is what determines the heat-absorbing power and the steam-making capacity of the boiler. If we can cause this to take up more heat in any way, we shall increase the power of the boiler. The *Serve* tube, with its ribs extending into the hot gases, increases the interior surface of the tube, and thus its capacity for absorbing heat. If, however, instead of putting ribs on the fire side of the tube, we put them on the water side, we increase the surface exposed to the water, but we make no increase of any practical importance in the amount of heat transmitted. In a similar way, the curved form of the tube, which causes the surface exposed to the water to be greater than that exposed to the fire (in fire-tube boilers), effects no increase in the amount of heat transmitted. The real heating surface, which determines the amount of heat transmitted, is the surface exposed to the fire.

Heating surface is almost invariably more or less coated with soot or ash on the fire side and with scale on the water side. If the preceding discussion has been carefully followed, it will be clear that the transfer of heat will be much more interfered with by the deposits on the fire side than by deposits on the water side. It is no part of the purpose of this paper to excuse lack of care in keeping boilers free from scale; but it is nevertheless quite certain that a thin scale on boiler tubes does not interfere in any noticeable degree with the capacity or economy of a boiler, while the coating of the fire side of the tubes with a flocculent deposit of soot does certainly interfere in a marked degree with a boiler's steam-making capacity. It may be worth while in this connection to administer a puncture to that hoary fraud which has been repeated in technical literature and trade catalogues "ad nauseam." I refer to a table purporting to give the loss of economy in per cents for each 1-16 in. of scale upon the heating surface of a boiler. In view of the fact that there are many varieties of boiler scale, varying widely in porosity and heat conductivity, and remembering that the thickness of scale in different parts of a boiler is never uniform, it hardly needs the discussion above to show the utter absurdity of this ancient "fake."

Another deduction of practical importance from the fact just set down, is that so far as the transmission of heat after the boiler is making steam is concerned, the circulation of the water in boilers is of a good deal less consequence than has been sometimes claimed. If anyone is inclined to stick to the old hobby that circulation is of great importance to economy, I advise him to

consider the conditions in the narrow water space (about  $3\frac{1}{2}$  inches wide) around a locomotive fire box, where the steam rushing up is directly opposed by the water going down. Good circulation is desirable to prevent unequal heating of the boiler, and consequent straining, and it may be of service in preventing deposits of scale and mud in places where they are least desirable; but that it has any appreciable effect on economy and capacity is not proved, and probably cannot be.

It has been demonstrated above that the surface exposed to the fire is the real heating surface of a steam boiler. Is there any good reason why this should not be generally adopted by engineers as the correct, and the only correct, method of computing heating surface? The following are some reasons, good or bad, which are likely to be urged against this.

1. The makers of fire-tube boilers will claim that this gives the water-tube boiler makers an advantage. With the same number of tubes in a boiler, of the same length, the water-tube boilers can show 7 to 11 per cent greater heating surface. This is of course true; but is it not an advantage to which the water-tube boilers are fairly entitled?

2. Another argument offered for the use of the exterior surface as the heating surface is that this makes a given boiler show a larger heating surface than if the interior were taken. However much the argument may appeal to boiler manufacturers—and I hardly think they will take it very seriously—it deserves no weight with engineers. A foot rule is no longer for calling it 13 inches.

3. It is urged that practice is and has in the past been fairly uniform in accepting exterior area as the heating surface, and it is best to stick to a uniform practice, even if it be in error, than to change. If the practice were actually uniform, there might be reason in this argument; but while the majority of engineers probably use the exterior surface of tubes in computing heating surface, there is a very respectable minority which insists on the correct method of computation, and this minority shows no signs of decreasing.

4. As the outside diameter of the tube is even inches and the thickness of tubes varies, it is easier to compute the exterior heating surface than the interior. Probably this is one of the principal reasons why the outside surface has so frequently been taken; but in these days of tables and pocket-books and aids to computations, so trifling a matter as computing the interior area of a tube ought not to be an excuse for perpetuating an error.

It appears to the writer that none of the arguments which have been cited in favor of computing the exterior surface of tubes as their heating surface are sound enough to justify engineers in perpetuating this error. If, however, for the sake of uniformity or ease of calculation, it should be thought best to use the exterior surface of tubes in computing heating surface, the fact that this is not the real heating surface ought to be kept clearly in mind. Misconception and wrong ideas on this point have been responsible for not a few mistakes and absurdities in the design of steam boilers.

#### AN IMPROVED HOLLOW CHISEL CAR MORTISING MACHINE.

To those who are engaged in making and repairing railway cars, or anything requiring heavy mortises, the No. 4 vertical hollow-chisel mortising machine with auxiliary boring attachments, shown herewith, will certainly prove of interest, since it is claimed to

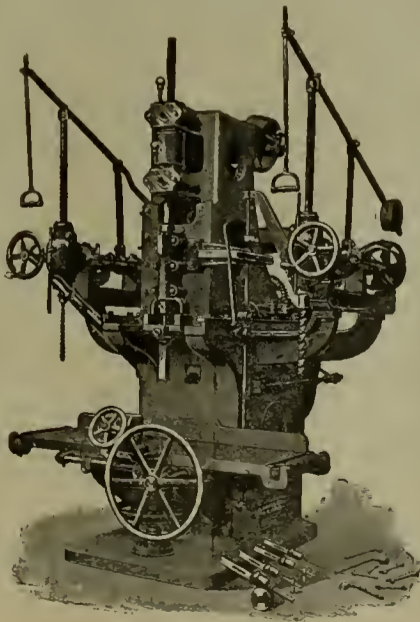

be the most powerful and reliable machine of its kind ever put on the market. The greatest care has been exercised to incorporate in this machine the es-

sential elements of a strong, simple and efficient mortiser, that produces its results to the entire satisfaction of the operator, and without the necessity of laying out the work or cleaning the mortises.

The frame is massive, made in a cored form with wide base, giving good floor surface, and carrying a cored housing, and with it the chisel-ram, the auxiliary boring attachments, and the timber-supporting table. The housing is gibbed firmly to the frame, with provision for taking up wear, and has a lateral movement, actuated by a lever, for moving the chisel to its required position above the timber. It is counterbalanced by a weight and lever, and supported on rolls which reduce the friction to a minimum in operation.

The chisel-ram is gibbed to the housing, and carries the boring spindle that prepares the material for the chisel-thrust; this boring spindle runs in a long, self-oiling bearing in the frame, and through the sleeve, bearings and pulley on the housing where the power is applied. There is a self-adjusting binder provided for always keeping the proper tension to the belt that drives the boring spindle. There are stops provided to regulate the vertical travel of the ram for the depth of mortise, and also for the lateral movement for its width. The vertical movement of the ram is 16 in., and the extreme lateral motion, with the housing, is 14 in.

The table for supporting the material is 4 ft. 6 in. long. It is provided with stops to regulate the travel to the length of the mortise required; is operated by a handwheel, rack and pinion; has an adjustable clamp for holding the material firmly in position, and a vertical adjustment.

The reciprocating motion of the chisel-ram is produced by reversing friction and gearing. The countershaft is placed above the machine, driving the friction by two belts, and also driving the boring spindle on the frame, and the auxiliary boring attachments.

The auxiliary boring attachments are placed one on each side of the frame, at such distance from the chisel as will permit of adjusting them to an angle of thirty degrees in either direction. These are convenient for joint-bolt boring, and save much handling of material. The spindles have a vertical adjustment of 20 in., and a lateral adjustment of 12 inches.

Car builders should find this improved machine, with its new special features and advantages to be a very valuable addition to their shops. Further information can be had from the makers, J. A. Fay & Co., 8 to 28 John St., Cincinnati, Ohio, U. S. A.

#### THE ASSOCIATION FOR TESTING MATERIALS.

A meeting for the organization of the American section of the International Association for Testing Materials was, says the *Iron Age*, held at Philadelphia, Pa., on June 16. Gus C. Henning, member of council, explained the aims and objects of the association and the problems which are before it for consideration. The following officers were then elected: Chairman, Prof. Mansfield Merriman, South Bethlehem, Pa.; vice-chairman, Prof. Henry M. Howe, New York; treasurer, Paul Krenzpointner, Altoona, Pa.; secretary, R. L. Humphrey, Philadelphia, Pa. These officers, with Gus C. Henning, ex officio, are to constitute the executive committee, to which was delegated the duty of proposing by-laws as well as nomination of members of sub-commissions. This executive committee was to report to the American section at a meeting to be held between the middle and end of August, 1898. It was decided that the section was to have one meeting a year, unless important work made it seem desirable to meet oftener. Two confidential councilors to represent the section at all council meetings were also elected—namely, Prof. Henry M. Howe and Dr. R. G. G. Moldenke.

The following problems are to be studied by the association:

The Sidero Chemical Laboratory. On the supervisory commission to manage the laboratory Prof. Henry M. Howe of Columbia University of New York was appointed.

Ways and means are to be sought to establish international standard specifications for the inspection of all kinds of iron and steel on the basis of those already existing. The American section shall appoint two members on the sub-commission taking up this subject.

Determination of methods of tests of the homogeneity of iron and steel looking to their eventual use in inspection, six members. Preparations of uniform methods of test of paints as protection against corrosion of railroad structures, four members. Unification of tests of terra cotta pipes. A sub-commission

of seven members, one from the American section, is to take up this subject.

Standard consistency of standard mortars. Determination of conditions which will produce approximately similar density of tension and compression briquettes, four American members.

Investigation of behavior of iron under abnormally low temperatures.

Methods of testing molds and weldability.

Collection of all information for preparation of standards for piece tests, with special reference to axles, tires, car springs, cast and wrought pipes, as well as of separate parts of structures.

Investigation of the most practically methods of polishing and etching for micrographic study of wrought iron.

a. Study of the relation of chemical compositions and weathering qualities of building stones. Study of effect of gases of combustion, especially of sulphurous acid. b. Method of determining the weathering qualities or properties of slate.

Determination of rapid methods for determining conditions of constancy of volume of hydraulic bond materials.

How can hydraulic bond materials be tested rapidly for their strength?

Study of resolutions of conferences relative to the determination of adhesive strength of hydraulic bond materials.

Investigation of causes of abnormal behavior of cements as to time of setting.

Investigation of the effect of fecal matter on the strength of hydraulic bond materials.

How can inspection of lumber insure protection against growth of fungi (*merulius lacrymans*)?

Determination of fundamental methods of testing lubricants (oils).

### A PNEUMATIC FLUE REDUCER.

A flue reducer that possesses several features which we think will command interested attention is shown in the engraving herewith, which quite clearly reveals its general design and more important details. It is known as the Whomes' pneumatic flue reducer. It is automatic in action, starting at the instant when the operator places a flue under the dies and stopping instantly on the withdrawal of the flue. Thus there is no power wasted, and no time wasted, in its operation. In fact, the output of the reducer is only limited by the capacity of the furnace and the agility of the operator. It is stated that 300 flues an hour can easily be reduced by this

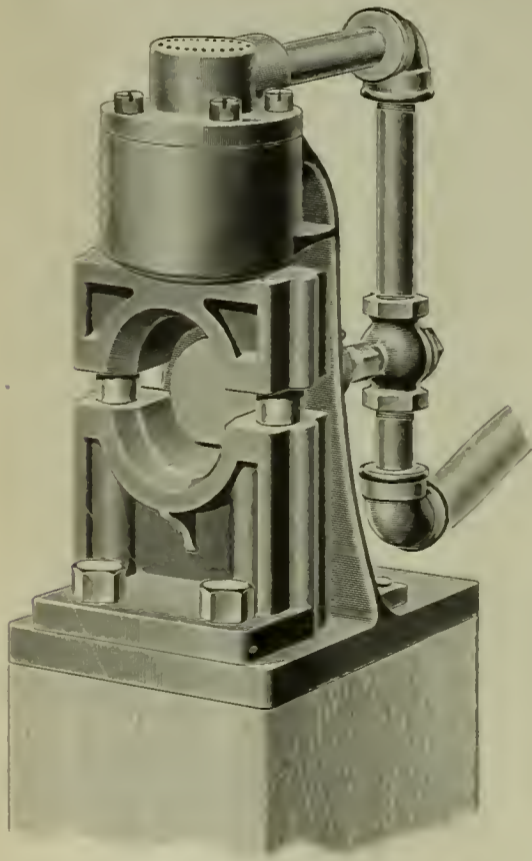

machine. The particular value of this reducer is credited to the fact that it takes flues from the welding machine and reduces them at the same heat, thereby avoiding the necessity of reheating and handling again. It is especially useful in connection with the Hartz machine, reducing the flues that they weld without consuming any more time than, it is claimed, effecting a saving of from 3 to 5 hours in every set of flues handled. The machine is 5½ x 7 in. at the base and 10½ in. high and can be placed most conveniently for the operator. It is adjustable to

flues from 2 to 2½ in. in diameter, only a few minutes being required to change the dies. This reducer is cheap, simple and durable and should find favor in railroad shops. It is offered by the Chicago Pneumatic Tool Co., Monadnock Building, Chicago.

### EXPERIMENTS ON THE FRICTIONAL RESISTANCE OF RIVETED JOINTS.\*

These experiments were designed with a view to determine the degree of influence exerted by frictional resistance under varying conditions on the strength and general efficiency of riveted joints, with particular reference to the exigencies of railway bridge design. Reference is made to the recent researches of Considère, of Bach, and of Dupuy, and the author indicates the details in which his own experiments are more complete, and the methods of measurements of stress and strain more accurate than is the case in the researches of his predecessors. The majority of the specimens tested were butt joints with a strap on each side secured by four single rivets. The plates and straps were of the same width and carefully machined. In the middle of the edge of each plate and strap and along the pitch line of the rivets on both sides small holes were drilled into which little three cornered rods were inserted. To these the two types of measuring gear were attached which admitted of the extension of each plate from rivet to rivet being measured, as well as the relative distortion of the rivet itself. Measurements were taken at regular increments of loads in kilogrammes per square millimetre (0.635 ton per square inch) of rivet area. The extenso-meters could be read, the author states, accurately to one ten-thousandth of an inch.

The experiments were divided into five groups:—

I. In this set of tests the straps were of the same thickness as the plates and riveted, four rivets.

II. to V. In these sets the straps were half the thickness of the plates. In Set II. and IV. the specimens were secured by four rivets; in Sets III. and V. by six rivets. Sets II. and III. were hand riveted; Sets IV. and V. were riveted by a hydraulic riveter.

Plates and straps were of wrought iron, 2.61 in. broad, and from ½ to 1 in. thick. The diameter of the holes was between ¾ in. bare and ¾ in. full, and the pitch of the rivets was 3-15 in. in specimens with four rivets, and 2-6 in. in the specimens with six rivets.

Particular attention was paid to the riveting, which was always carried out under proper supervision. Five specimens were prepared for Sets I. to III., and in some of the specimens compared in these groups the rivet holes were carefully rimmed out, and the rivets, when heated to a cherry red, fitted so well that considerable force was required to drive them home. The object of this was to get as solid a joint as possible in order to form a basis of comparison with the behavior of other joints in Sets IV. and V., in which the rivet holes were purposely bored with varying diameters. Generally the scheme of the experiments was to determine:—

- (1.) The influence of the temperature of the rivet.
- (2.) The influence of a conical thickening under the rivet head where closed.
- (3.) The influence of too large holes.
- (4.) The influence of continued pressure after closing.

It must be understood that the division into groups only has reference to the relative thicknesses of the plates and straps. In Groups I and II., for example, there were specimens prepared with well-fitting and badly-fitting holes. The main results of the experiments are as follows:—

The amount of permanent set is considerably reduced by continued pressure, and the load at which permanent set is first observed is increased. The effect of giving the rivet holes a slightly larger diameter than the rivets was, without exception, to increase the load at which any relative movement of the plates and straps was observed.

A very complete table of results is compiled, from which the author draws the following conclusions:—

The elastic relative movement of plates and straps is not proportional to the load on the joint, but is dependent rather upon the frictional resistance of the plates and straps.

The resistance to tension is made up of friction between the plates and the shearing strength of the rivets. When the load is removed, the strained rivets can only regain their original form by overcoming this plate-friction, and the greater this friction, the less will the rivet get back to its original state. From the graphic results quoted in the paper it is seen that where the rivets have had a loose fit in the holes the frictional resistance in the hand-riveted specimens is greater—although the permanent set is also greater—than in the specimens in which the rivets fitted the holes exactly.

The increase in frictional resistance is not so marked in the specimens in which the straps were thicker than the plate. Hydraulic-riveted specimens approached very nearly in their behavior to those in which the rivets fitted the holes exactly. Experiments showed that

\*Abstracted from the proceedings of the Institution of Civil Engineers.

repetitions of load did not cause any decrease in the frictional resistance. The ultimate strength of the joints was not investigated. It is curious and important that a joint in which the rivets exactly fit their holes should turn out to be the least satisfactory from the bridge builder's point of view. It would appear from the results of these experiments that the most favorable result is obtained—in hand-riveting—when the rivets are originally a loose fit in the holes, and when the strap is half the thickness of the plate.

### THE MASTER CAR AND LOCOMOTIVE PAINTERS' ASSOCIATION.

The Master Car and Locomotive Painters' Association will hold its twenty-ninth annual convention in the city of St. Paul, Minn., on the 13th, 14th, 15th and 16th days of September, 1898, convening at 10 o'clock a. m. on Tuesday the 13th. The daily sessions will be held in the club room of the Ryan hotel, which is designated as the official headquarters of the association.

Special rates have been granted all in attendance (American plan) as follows: Rooms for one person \$3.00 per day; for two persons in one room, each \$2.50 per day. Rooms with bath attached, for one person \$3.50 per day; for two persons in one room, each \$3.00 per day. The management desires that those attending the convention will make application for rooms at least two weeks before the date of meeting.

A general invitation is cordially given to all master car and locomotive painters to attend the convention. Every railway in the country should be represented by one or more of their foreman painters, as each division shop is entitled to membership in this association, also all car manufacturing and locomotive shops are entitled to representation and to membership by their foreman painters.

The subjects coming before the convention are such as should interest the progressive master car painter. Exchange of views and methods of working in different shops is always instructive to those attending the convention. There is always opportunity given for an interchange of ideas on all subjects coming up for discussion.

The following is the list of subjects with the committees who will report on them:

No. 1. Quick drying colors for passenger cars and locomotives. Should they be prepared to dry flat or mixed with a small portion of linseed oil (a specially prepared quick oxidizing oil) or rubbing or wearing body varnish, so as to dry with an egg-shell gloss. Committee—W. J. Ori, Lake Shore & Michigan Southern Ry., Norwalk, O.; G. W. Lord, Fitchburg R. R., Fitchburg, Mass.; F. F. Fisk, Toledo, St. Louis & Kansas City R. R., Frankfort, Ind.

No. 2. The railway paint shop stock room. The care of paint stock, brushes and other tools, giving them out, keeping the record of stock used, etc. Committee—Jno. Hartley, Atchison, Topeka & Santa Fe R. R., Topeka, Kan.; W. C. Fitch, Southern Pacific Ry., Sacramento, Cal.; R. H. Dennison, Philadelphia & Reading R. R., Reading, Pa.

No. 3. Classification of painting repairs on the outside and inside, body of passenger cars. Committee—F. S. Ball, Pennsylvania R. R., Altoona, Pa.; C. E. Copp, Boston & Maine R. R., Lawrence, Mass.; G. R. Cassie, Lake Shore & Michigan Southern Ry., Adrian, Mich.

No. 4. Painters and painting, as compared with and related to other mechanical departments of railway work. Committee—J. A. Goben, C. C. C. & St. L. Ry., Indianapolis, Ind.; J. H. Pitard, Mobile & Ohio R. R., Whistler, Ala.; C. E. Koons, St. Louis Car Co., St. Louis, Mo.

No. 5. The difficulties and environments of the master car painter. Committee—T. Baker Hall, Wason Car Manufacturing Co., Springfield, Mass.; A. J. Bruning, Louisville & Nashville R. R., Evansville, Ind.; F. W. Wright, Michigan Central R. R. (Canada Div.), St. Thomas, Ont.

No. 6. A historical sketch of railway equipment—Painters and their work in the early days. Committee—Warner Bailey, Maine Central R. R., Concord, N. H.; J. A. Putz, Wisconsin Central R. R., Stevens Point, Wis.

No. 7. Do the railway companies give proper consideration to the painting of freight cars. Committee—B. G. McMasters, Illinois Central R. R., Chicago, Ill.; A. R. Lynch, P. C. C. & St. L. Ry., Dennison, Ohio; H. W. Flanagan, Chicago & Great Western R. R., St. Paul, Minn.

No. 8. The advantages derived in having a suitable shop for painting locomotives in, instead of doing the work in round houses and machine shops. Committee—A. P. Dane, Boston & Maine R. R., Boston, Mass.; Ewd. McLaughlin, Missouri, Kansas & Texas R. R., Parsons, Kan.; Fred Heisel, Cincinnati, Hamilton & Dayton R. R., Cincinnati, O.

No. 9. Are the railways justified in surfacing and varnishing passenger equipment cars and locomotives. Committee—J. F. Lanfersiek, P. C. C. & St. L. Ry., Columbus, O.; A. J. Bishop, Northern Pacific R. R.,



St. Paul, Minn.; W. J. Russell, Grand Rapids & Indiana R. R., Grand Rapids, Mich.

No. 10. What progress, if any, has been made in the past year in paint spraying. Committee—J. A. Gohen, C. C. C. & St. L. Ry., Indianapolis, Ind., F. H. Crocker, Kansas City, Ft. Scott & Gulf Ry., Kansas City, Mo.; H. M. Smithson, Texas Midland Ry., Terrell, Tex.

Topical questions.—1st Do you paint roofing tin on both sides? 2nd. What is the best filler for hard wood? 3rd. What is the best varnish remover? 4th. Is there an advantage in the use of the gilding wheel? 5th. Which is the best for general purposes—grain alcohol, wood alcohol or alkaline.

Robert McKeon, Kent, O., is secretary of the association

The rules of interchange, as revised at Saratoga, N. Y., in June, which go into effect on September 1, 1898, are ready for distribution and will be furnished at the same rates as heretofore, viz.: Twenty-five copies, \$1; 50 copies, \$1.75; 100 copies, \$3. A less number than 20 copies, at five cents per copy. Postage will be added in all cases when sent by mail.

The National Railroad Master Blacksmiths' Association will hold its sixth annual convention in Boston, Mass., commencing September 6, 1898. The American House, situated on Hanover street, has been designated as the official headquarters of the association during its stay in Boston.

### BEST FORM OF FASTENING FOR LOCOMOTIVE CYLINDERS.\*

The instructions to your committee contained in the two words "Cylinder Fastenings," are not very clearly defined, and might consistently be considered as embracing the entire designing of locomotive frames, cylinders, and parts of the boiler, or might be laconically summed up in the three words, "Bolts and Keys."

It is believed, however, that a middle course between the extremes of prolixity and brevity will be the most useful, and the following report confines itself to the discussion of the points bearing on "Cylinder Fastenings" for cylinders and frames of the types familiar to us all.

I believe that for modern weights and powers of locomotives, if the frames, cylinders and boilers are to stay together without a loose bolt key or crack (barring wrecks, of course) from the time the engine leaves the builders until it goes on the scrap pile, absolute rigidity and unity is imperatively necessary. The boiler, cylinders and frames should, under all conditions, be absolutely inflexible and immovable relative to one another; all necessary limberness of the machine as a whole must be provided for by the springs and system of equalization.

The strains that the "Cylinder Fastenings" have to resist are:

First: The direct alternating thrust of the steam in the cylinders at the frames up to, say, 38 tons, reversing itself several hundred times a minute and increased to unknown amounts by shocks due to water in the cylinders. For instance, to knock out a 22-inch cylinder head would require something like 125 tons pressure suddenly applied, and the cylinder fastenings must not be phased by this.

Second: The direct forward and backward surging of the boiler—as the back end of the boiler must be on slides or links to allow for expansion and contraction, the cylinder saddles alone must resist the tendency of the boiler to move lengthwise, due to train and coupling shocks, collisions, etc. What the shearing strains on the saddle bolts and cracking strains on the saddles are when the momentum of one of our huge modern boilers is suddenly destroyed is not easy to conjecture.

Third: Forward and backward sliding of the two saddles on one another, due to the cranks being at right angles and the impulses in the cylinders not occurring simultaneously. This is greatest at the bottom at the level of the centers of the cylinders and least at the top of the saddle.

Fourth: Wrenching strains due to the engine curving, where one side of the engine must be held back by the other, and the adhesion of the wheels on the inner rail constantly broken. As there is no diagonal bracing to keep the frames from moving lengthwise separately from one another, this purpose must be accomplished by the strength of the cylinder saddle. Similarly, if the engine slips and happens to catch on one side first, very severe wrenching strains are produced in the saddles.

Fifth: The forward thrust on the cylinder and

steam-box bolts, due to the expansion of the boiler and resistance sometimes offered by the back boiler fastenings being defective or jammed.

Sixth: Wrenching of the saddle, due to the back end of the boiler swinging laterally on the frames; this is a very frequent defect with long boilers having heavy fire boxes, and is especially noticeable on engines having poor back boiler fastenings when they are slipping.

As to this last—sixth—cause is attributable most of the trouble with looseness between the smoke boxes and saddles, we refer to this matter first. If we wish to steady a pendulum, hammer or axe from moving, we fasten it by the weight or head, we do not leave the heavy end insecure and then attempt to prevent it moving by gripping the end of the handle extra tight. Similarly, the place to remedy the looseness of the cylinder saddle and smoke-box joint is at the back end of the boiler.

In reviewing the information gathered on this head, we see that the best designs for securing the back ends of boilers to frames to prevent wiggling would be such that:

The weight of the boiler should be carried on two, or preferably four, long slides up to 12 inches in length and over.

The weight of the boiler should be transmitted directly from the mud ring to the top of the frame through substantial chafing pieces on the frames, which can be easily renewed if worn; the mud ring being machined where it rests on these.

The weight of the boiler should not be carried by pads on the sides, depending on studs or rivets.

The boiler should be held down firmly to place by four side clamps, which are not depended on to hold the boiler laterally.

In addition to the lateral security afforded by bearing pieces the boiler should be held to place laterally by strong bracing placed crosswise under the boiler at the front of the fire box, and, where practicable, across the back of the fire box where the material can be disposed in the best direction to resist lateral movement, and tie both frames together.

The boiler should also have at least one expansion brace to help keep the boiler and frames from the slightest relative movement or springing; but to be of lasting service this expansion brace must be made with double heavy angles at the boiler, close riveted to the shell ( $2\frac{1}{2}$  to 3 inches spacing,  $\frac{3}{4}$ -inch rivets), and similarly close riveted in reamed holes between the angles and the expansion plate, and firmly secured to the cross brace, which must be well lipped over and bolted to both frames. By using a broad steel casting for the cross brace greater stiffness is obtained and it helps to brace the frames. To use a single T or angle iron at the boiler with a few bolts to hold the plate to this is a dead waste of material.

Carrying the back end of the boiler on links and pins is bound to lead to trouble sooner or later. The bearing surfaces cannot be large; they will be hot all the time, and as they cannot be successfully lubricated, must be made a loose fit to start with or they seize and they wring off. When this made a loose fit they permit the initial looseness which, with the constant jarring and pounding of the weight of the boiler on these two or four pins, soon produces considerable slack which will break off the pins eventually and in the meantime allow the back end of the boiler to waggle on the frames, thus wrenching the cylinder and smoke-box fastenings severely. The smoke boxes of our heavy engines have been too often made as if they had no other duty to perform than to hold smoke, and because they have no steam pressure to retain are made of flimsy sheet steel, whereas the smoke box is really a part of the foundation of the whole machine.

How can we expect to hold the heavy boiler firmly to the cylinder saddle and frames without any buckling and giving when the smoke box is only made of 5-16 or  $\frac{3}{8}$  metal? The smoke box should be made of as heavy plate as the boiler itself, and there should be a strong attachment to the boiler by means of a wide 1-inch thick ring, as well as a second ring at the front of the saddle and bars 8 to 10 inches wide, as shown in Fig. 1, all closely riveted to the smoke box. This gives all the bolts through the saddle and smoke box the same length and a good  $1\frac{3}{4}$  inches of metal for reaming to a good fit.

One member very pithily writes: "We find that too many bolts cannot be used in securing the saddles to the smoke boxes;" but it is believed that if the back ends of the boilers are well secured as recommended previously, fastening the saddles to the smoke boxes with a double row of  $1\frac{1}{4}$  or  $1\frac{3}{8}$  inch bolts all around, spaced  $4\frac{1}{2}$  inches or not over 5 inches pitch, having the flanges of the saddles strengthened by ribs all about as shown on Fig. 1, will form, with honest workmanship, as secure a fastening as is needed, but not more than is really essential for heavy locomotives. All the bolts holding the saddle to the smoke box should be on the outside of the saddle in the flange, with heads inside and nuts underneath where they can be seen. Bolts inside the saddle put up from underneath

which cannot be made a driving fit, and the nuts for which must be inside the smoke box, are believed to be not worth the trouble of putting in. They cannot be properly fitted or inspected afterwards for looseness; the nuts are subject to the heat, and being located near the center of the saddle they have not the same leverage to hold the saddle steady as they would have if placed on the outside.

Considering next the fastening of the two cylinders together, it must be remembered that the force tend-

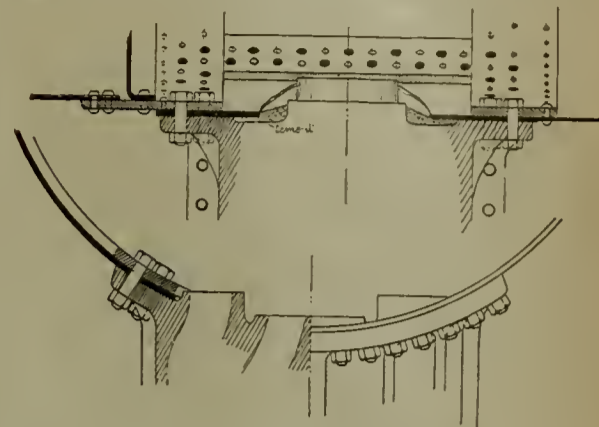

FIG. 1.

ing to separate or slide on one another is exerted at the bottom on the plane of the centers of the two cylinders and not at the top. To resist this to the best advantage, the strength of the fastening should be at the bottom and not at the top, and yet we find arrangements where the bolts are very poorly disposed. The continual trouble from loose and cracked cylinders has led to the very common use of cross-frame braces lipped over the frame bars and shrunk on, both front and back of cylinders on both upper and lower frame bars. This is certainly a reasonable disposition of the metal to effect the intended purpose.

But it is believed that if the saddles are correctly designed in other respects and the frames properly proportioned and connected, such clamps will not be found necessary, but the saddles should be bolted together and it is a good plan to fit one or perhaps two good keys in this bottom horizontal joint to relieve the bolts from shearing strains.

Before discussing the fastening of the cylinders to the frames, there are some questions strongly bearing on this which may be profitably considered. Referring to the strains on the cylinders and saddles previously described in the six numbered paragraphs, it will be seen that there are some that must be wholly absorbed by the strength of the saddle. The plain bottomless box form of saddle with cored steam and exhaust passages looks massive enough, but the metal is disposed in the weakest possible form to resist the strains referred to. Above all, there is need of plenty of metal 10 feet as a horizontal bed plate at or near the plane of the center lines of the cylinders. We find efforts to remedy this lack by numerous clamps shrunk on in front and back of the cylinders to strain them tighter together, but here again the metal is applied at right angles to the direction of the strains. We also find horizontal plates applied front and back of the cylinders lipped, for the frames; in some instances these being bolted to flanges cast on the saddles for the purpose, and again others have been driven to the use of long cast-iron bumper deck plates, filling the entire space from the saddle to the front bumpers. All these are remedies for an originally bad design. There seems to be some tradition, that no one has yet broken away from, that the saddles must not be any longer than the cylinders. For instance, for a 14 by 24 inch cylinder the saddle would be about 28 inches long; for a 33 by 24 inch cylinder, the saddle would still be 28 inches long. The length of the saddle is its strength to a large extent.

Is there any reason why the saddle should not be made 6 feet long between the frames and thus furnish horizontal longitudinal stiffness which would keep the cylinders and frames square? This would do away with the necessity for clamps, plates and extra castings. But there are still formidable strains on the saddles that require additional strength in the upper part, and it is certainly good practice to rib the saddle vertically on both sides, front and back, and also use horizontal ribs.

Reverting to the argument previously made in favor of rigidity and against elasticity in the construction of the frames and attachment to the cylinders, it will be admitted that the recommendations of several prominent members to the effect that double-bar frames should be always used for heavy locomotives even of the eight and ten wheeled types, is in the right direction and we recommend this as good practice.

Where single-bar frames for special reasons must be used, they should be made of proportionately greater strength. It seems absurd to continue using 4 by  $4\frac{1}{2}$  single-bar frames for all sizes and powers of locomotives.

The details of the fastening of the frame bars to the

\*From a report presented at the 1898 convention of the American Railway Master Mechanics' Association.

cylinders must depend on the height and spread of the cylinders, height of center of axles, diameter of truck wheels and necessary clearances, so that all that can be done without knowing these limiting conditions is to present a number of sketches showing various designs for attachment of double-bar frames to cylinders, see Fig. 2.

There are, however, some points that are common to all that should be mentioned. Long vertical bolts through both top and bottom frames and cylinders should be avoided. They are expensive to turn, the reamers are expensive and most difficult to make, the castings are troublesome to core and the strength under equal tightening is not the same as for the short bolts.

Tap bolts might just as well be left out, to start with, for all the good they ever do.

Keys between the cylinders and frames should be made large enough and very carefully fitted to a perfect bearing before final driving.

Both top and bottom bars should butt solid up against the back of the cylinders, being machined to a gauge, and the cylinders faced off accurately; this insures perfect squareness, keys being used in front to draw the frames up solid to the cylinders before the bolt holes are reamed. Continued trouble with loose splice joints in the frames has led to the use of blocking castings between the top and bottom bars of the frames

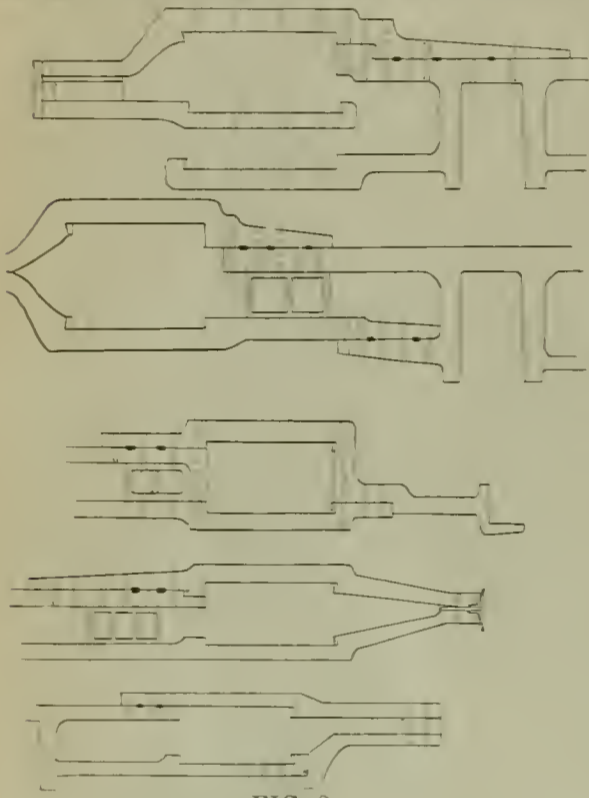

FIG. 2.

behind the cylinders, and there is no doubt this is very good practice. This same trouble has led some to do away with one splice joint, and carry the main frame forward to the front edge of the cylinder; but if this is done the top frame, which is the main strength of the frame, should be carried forward over the cylinder, giving a solid forging from the front of the saddle to the back tail bar.

Finally it may be predicted that a few years will see the very general use of cast steel for locomotive frames, and as the possibilities with this metal are great, it may be that we will find both frames and cylinder saddles all cast in one piece with the two cylinders and the upper part of the saddle made of cast iron and bolted on.

R. P. C. Sanderson,  
T. L. Chapman,  
Of the Committee.

### PERSONAL.

Mr. P. P. Hinton has been appointed purchasing agent of the Louisville & Nashville Terminal Company.

Mr. M. S. Curley has been appointed master mechanic of the shops of the Illinois Central at Water Valley, Miss.

Mr. Willard Kells has been appointed master mechanic of the Chicago & Erie R. R., vice Mr. J. Hawthorne, resigned.

Mr. John T. Gil has been appointed air brake instructor of the Grand Trunk Railway system, with headquarters at Montreal, Can.

Mr. W. W. Lowell has been appointed master mechanic of the Hannibal & St. Joseph, at Brookfield, Mo., to succeed Mr. C. E. Lamb.

Mr. Edward D. Satz has been appointed purchasing agent of the Louisville, Evansville & St. Louis in place of Mr. W. W. Wentz, resigned.

Mr. J. H. Hawthorne, master mechanic of the Chicago & Erie at Huntington, Ind., has resigned, to accept a position with the Lehigh Valley.

Mr. W. W. Wentz, Jr., has resigned as purchasing agent of the Louisville, Evansville & St. Louis, to accept a position on the Central of New Jersey.

Mr. Frank Johnson has been appointed master mechanic of the Mahoning division of the Erie, vice Mr. Willard Kells, promoted to be master mechanic of the Chicago & Erie.

Mr. Harry Lydden, foreman of the Northern Pacific shops at Mandan, N. D., has been appointed general foreman of the shops at Brainerd, Minn., to succeed Mr. F. P. Barnes, promoted.

Mr. E. W. Knapp has been appointed master mechanic of the Michoacan & Pacific, in charge of the motive power department, with headquarters at Zimacaro, Mex., vice Mr. W. H. Rice, resigned.

Mr. F. P. Barnes has been appointed master mechanic of the Northern Pacific at Missoula, vice W. S. Clarkson, transferred. Mr. Barnes has been hitherto general foreman of the Northern Pacific's Brainerd shops.

Mr. C. E. Lamb, formerly master mechanic of the Hannibal & St. Joseph at Brookfield, Mo., has been appointed master mechanic of the Kansas City, St. Joseph & Council Bluffs Railroad, with office at St. Joseph, Mo.

Mr. W. E. Symons has been appointed superintendent of motive power of the Plant system. Mr. Symons was formerly division master mechanic of the Santa Fe road at various points and was lately with the Galena Oil Company.

Mr. Joe Blackburn, formerly master car builder of the central branch shops, at Atchison, has been transferred from the Union Pacific shops at Denver to the position of master car builder in the Oregon short line shops at Salt Lake City.

Mr. P. H. Wilhelm, for several years general agent of the New York Car Coupler Company and afterwards agent for the Buckeye Coupler Company, was last month appointed agent for the Railroad Supply Company which handles the Hien coupler.

Mr. A. L. Moder, whose resignation as master mechanic of the St. Louis, Peoria & Northern was announced in our last issue, has accepted the position of president and general manager of the Thompson Smelting & Refining Company of St. Louis, Mo.

Mr. John T. Peach, foreman of the roundhouse of the Atchison, Topeka & Santa Fe at Topeka, Kan., has been appointed general foreman at Fort Madison, Ia., in place of Mr. Wintercheck, who has been transferred to Albuquerque, N. M., as general foreman.

Mr. W. S. Clarkson, formerly master mechanic of the Rocky Mountain division of the Northern Pacific, at Missoula, has been appointed master mechanic at Livingston to succeed Mr. Angus Brown, who resigned to accept the position of superintendent of motive power of the Wisconsin Central.

Mr. H. Tandy, for many years with the Brooks Locomotive Works, has resigned to accept the position of superintendent of the Kingston Locomotive Works, of Kingston, Ont. Mr. Tandy's many friends will regret to learn that he is leaving the States, but will find comfort in the fact that he is not going far away.

Mr. Angus Brown, master mechanic of the Northern Pacific, at Livingston, Mont., has resigned to accept the position of superintendent of motive power of the Wisconsin Central lines with office at Waukesha, Wis., to succeed Mr. James McNaughton, recently resigned to become superintendent of the Brooks Locomotive Works.

Mr. John Hawthorne has been appointed Master Mechanic of the Pennsylvania & New York Division of the Lehigh Valley at Sayre, Pa., vice Mr. J. N. Weaver, resigned. Mr. Hawthorne will also have supervision of Motive Power affairs on the Auburn Division, assisted by Mr. George F. Richards, Assistant Master Mechanic, with office at Cortland, N. Y.

Mr. B. E. Fernow, for many years chief of the division of forestry, United States department of agriculture, relinquished on July 1, the post he has so long and honorably filled to accept the directorship of the newly-established State College of Forestry, at Cornell University. Professor Fernow has been a successful leader in forestry work and his thorough studies in the strength of timbers are familiar to our readers.

Mr. R. E. Smith, heretofore superintendent of motive power of the Atlantic Coast Line, has been appointed as assistant to the general manager of that system, with headquarters at Wilmington, N. C. Mr. Thomas H. Symington, formerly assistant superintendent of the Richmond Locomotive & Machine Works, has been appointed superintendent of motive power of the Atlantic

Coast Line with headquarters at Wilmington, to succeed Mr. Smith.

Mr. George W. Stevens has resigned the position of purchasing agent and superintendent of car service of the Cincinnati, New Orleans & Texas Pacific, to become purchasing agent of the Mobile & Ohio, vice R. H. Duesberry, resigned. Mr. G. B. Nicholson, chief engineer of the C., N. O. & T. P., in addition to his present duties has been appointed purchasing agent. The office of superintendent of car service is abolished and the car records will be placed in charge of Mr. C. H. Davis, auditor.

Mr. H. A. Bowen, who for the past seven years has been with Swift & Co. as mechanical superintendent, has resigned his connection with that company. Mr. Swift's work while with this company, in charge of its shop work, designs and repairs, and its important relations with railway companies in regard to the interchange of cars, has resulted in his becoming one of the foremost of "private car line men" in the railway mechanical world. That he will continue in railway work will be the warm desire of the many friends which he has made during his connection therewith.

On the New York, New Haven & Hartford, which on July 1 assumed the direct operation of the New England and the Shepaug, Litchfield & Northern Railways, and the property of the Old Colony Steamboat Company, the Providence & Stonington Steamboat Company and the Norwich & New York Transportation Company, the following appointments, among others, have been made: H. A. Bishop, purchasing agent, office at New Haven; R. W. Husted, assistant purchasing agent, office at Boston; E. P. Trowbridge, stationer, office at New Haven; John Henney, superintendent motive power, office at New Haven; F. B. Smith, general master mechanic, and W. P. Appleyard, master car builder, offices at New Haven; N. H. Heft, chief of electrical department, office at New Haven; F. H. Crane, superintendent of parlor and sleeping cars, office at Grand Central depot, New York.

### SUPPLY TRADE NOTES.

—The Schoen pressed body and truck bolsters are to be used on the 3000 cars recently ordered of the Michigan Peninsular Car Company.

—Pawling & Harnischfeger of Milwaukee have received a contract from the Aetna Standard Iron & Steel Company, Bridgeport, O., for six cranes ranging in capacity from 15 to 20 tons.

—The O'Neil Crossing Alarm Company, Cleveland, O., reports that its highway crossing alarm is now in use on 40 of the leading railroads, many using it exclusively.

—The Mechanical Manufacturing Company, Union Stock Yards, Chicago, has an order to furnish 28 Ellis passenger car bumping posts for the new terminal station of the New York, New Haven & Hartford, at Boston, Mass.

—The Rodger Ballast Car Company are furnishing 42 of their ballast cars to be used on the Lehigh Valley Railway for handling crushed stone ballast. These cars are of the 40-ton standard and have a capacity for 30 cubic yards of crushed stone.

—The Railway Cycle Manufacturing Company of Hagerstown, Ind., has recently shipped twelve double inspection cars to Russia, seven single and three double to Germany, several to China and South America and has orders for six more for Germany.

—At the meeting of the directors of the Weber Railway Joint Manufacturing Company, held recently, the following officers were elected: Emil Greeff, president; E. Y. Weber, vice-president and treasurer; G. A. Weber, secretary; Percy Holbrook, general manager.

—The Sargent Company announces the largest month's business in patented brake shoes in the history of the company for June, 1898. They are extremely busy in the steel department and running to the full capacity, with prospects of heavy business throughout the year.

—The Chicago grain door has been specified on the 1000 C., M. & St. P. box cars to be built at West Milwaukee shops, also on the 1000 Northern Pacific box cars recently ordered from the Michigan Peninsular Car Company and the Illinois Car & Equipment Company.

—The Pennsylvania Car Wheel Company, Pitsburg, Pa., intends to double the capacity of its works at Allegheny. This company has received a contract for 8000 wheels to be used under the 100,000 lbs. capacity cars now building for the Pennsylvania railway. It has also received some other large contracts.

—The Westinghouse Machine Company and the Westinghouse Electric & Manufacturing Company invited a large party to attend their works at East Pitsburg, Pa., on the afternoon of July 30, to inspect new

and interesting engines and electrical machines finished for immediate shipments to foreign markets.

—The engineering laboratory of Purdue University is in receipt of a complete outfit of locomotive lamps, consisting of one pair of Herculean engine classification lamps, one steam gage lamp and one water gage lamp, all from the Dressel Railway Lamp Works of New York City. These lamps are presented as a mark of esteem by their makers.

—The Matthews Fence Company of Jacksonville, Ill., report a very good business. The company will build this fall extensive additions to their shops. They manufacture fence, steel posts, railway signals and gates. The company have just finished a large order for the government, and has several large orders on hand for different railway companies.

—Recent press reports state that a water tank at Dallas, Tex., built by the "Batavia Company," collapsed. As the United States Wind Engine & Pump Company, of Batavia, Ill., is not infrequently spoken of as "The Batavia Company" we desire to state that the tank in question was not built by the United States Wind Engine & Pump Company, but by another concern which has its factory in Batavia, Ill.

—W. D. Sargent, president of the International Brake Shoe Company, sailed July 6 for Europe to make arrangements for the manufacture of the Diamond "S" shoe in several European countries, including Russia. The success of this shoe since its introduction last fall has been little short of phenomenal, and we doubt if any railway device of recent invention has been so thoroughly and consistently pushed on all occasions as this brake shoe.

—The Diamond Machine Company, of Providence, R. I., in addition to their large line of grinding machinery, make a great many special machines, both from their own designs and from drawings of customers. They made the machine on which the now well-known "Christy" bread knives were ground automatically, and have just finished a machine for grinding a new patented bread knife on a somewhat different principle from the Christy.

—The Northern Pacific Railway Company have placed an order with the Rodger Ballast Car Company for 200 of their standard 40-ton ballast cars. These cars are fitted with coal sides to be used in handling coal during the winter season. They will be built under contract with the Wells & French Company, and the delivery will be completed by Sept. 1st. These cars are all fitted with the 40-ton Common Sense steel bolsters, body and truck.

—The Chambersburg Engineering Company of Chambersburg, Pa., has received an order for a hydraulic riveting plant to be erected in the Pittsburg Locomotive Works, which plant is to be one of the largest ever built. The riveter when complete will weigh 80,000 lbs., and will stand 16 ft. above and extend 9 ft. below the floor line. The Chambersburg company will also construct a 20-ton hydraulic crane for handling the work to be done by this riveter.

—The Schoen Pressed Steel Company of Pittsburg is building an addition to its plant. The building will be of steel, 650 ft. long by 120 ft. wide, and will be equipped with overhead tramways, four overhead cranes, each with 60 ft. span and a full complement of machinery. It is to be finished by Sept. 1, 1898. This will increase the capacity of the works to 30 steel cars per day. They have recently received orders for pressed steel bolsters for 3750 cars to be built for the B. & O. by the Michigan Peninsular and the South Baltimore Car Works.

—Williams, White & Co., Moline, Ill., are preparing to build an addition to the present foundry that will double the size and capacity. The new foundry building has been planned to be 160x80 ft. which will give the plant double the amount of room now occupied. The building will be of brick, iron and glass in modern style and will be located just west of the present foundry. Owing to the increased foundry business of late years the building has been needed for some time and with the advent of better times the managers foresee that their present capacity will be entirely insufficient. The firm is also contemplating the addition of another crucible.

—The McCord journal box and lid have been specified on 250 cars for the St. Joseph & Grand Island; on 500 cars ordered by the Northern Pacific from the Michigan Peninsular Car Company; on 35 logging cars for the Brainard & Northern Minnesota, ordered from the Illinois Car & Equipment Company; on 25 cars ordered by the Iowa Central from the St. Charles Car Company; on 200 cars for the Minneapolis & St. Louis, ordered from the Michigan Peninsular Car Company; on 20 cars for the Rio Grande & Eagle Pass, and on 250 cars for the Delaware & Hudson Canal Company, ordered from the Buffalo Car Company, being made the standard on the last named road.

—The Case Manufacturing Company, of Columbus, O., has recently made sales as follows: The Reeves Iron Company, Canal Dover, O., one 15-ton electric 3-

motor crane; the National Electric Company, Brooklyn, N. Y., 92-ft. 25-ton crane; the Dayton Globe Iron Works, Dayton, O., 8-ton hand power crane; the Bullock Electric Manufacturing Company, Cincinnati, O., 20-ton electric crane; the Dresden Iron & Steel Company, Dresden, O., 15-ton crane. The Case company has recently put in operation one 75-ton crane for the Johnstown Tin Plate Company, Johnstown, Pa.; one 15-ton electric traveling the Lewis Foundry & Machinery Company, Kansas City, Kan.; two 30-ton electric traveling cranes shipped to Sidney, New South Wales; two 10-ton and one 15-ton electric 3-motor traveling cranes for the Laughlin Iron Works, Wheeling, W. Va.

—The American Wheelock Engine Company, of Worcester, Mass., builders of the Greene-Wheelock engine, with Hill valve gear, have lately met with marked success in installing the Greene-Wheelock engine. Among the plants now in course of erection or construction in the company's shops, and those recently installed, are as follows: 6 1500 h. p. engines for the Chicago City Railway Company, with rope drives; 1 600 h. p. single cylinder, condensing engine for the Worcester Wire Mill; 1 200 h. p. for Hammond Reed Company, Worcester; 1 1000 h. p. for B. B. & R. Knight, Providence; 1 550 single cylinder and 1 550 cross compound, with rope drives, complete, for Syracuse Construction Company; 1 400 h. p. for the Willamette Pulp & Paper Company, Oregon City; 1 300 h. p. and 1 350 h. p. for Pejepsot Paper Company, Brunswick, Me.; 1 750 h. p. direct connected for the New York Heat, Light & Power Company; 3 350 h. p. direct connected for the J. G. White & Co., New York; 2 500 h. p. cross compounds, direct connected, for Potomac Electric Power Company, this being the second order from them, previous order being 2 750 h. p. direct connected. The company have installed at the Grosvenor-Dale Electric Light plant, Grosvenor-Dale, Conn., the high pressure side of a cross compound, putting their cylinder and valve gear onto Corliss bed, replacing Corliss cylinders. This is the second Corliss engine in the Grosvenor-Dale plant that they have replaced with their cylinder and valve gear. The company are now building for Bibb Manufacturing Company, of Macon, Ga., the high pressure side of a 750 h. p. cross compound, the low pressure side to be one of their low pressure cylinders with valve gear, which replaces the Corliss cylinder and valve gear now on.

WANTED—Position as superintendent of manufacturing concern or as in charge of car repairs and shop work. Large experience handling men. Best of references. Address A. B. care Railway Master Mechanic.

Important to Railroad Managers and Master Mechanics.

## SIBLEY'S Perfection Valve Oil.

More perfect valve lubrication and entire freedom from corrosion or honeycombing of cylinders, and destruction of joints of steam chests by fatty acids.

In Exclusive Use on Nine-Tenths of the Railroad Mileage of the country.

Reference furnished upon application.

MAKE EXCLUSIVE SPECIALTY OF VALVE AND SIGNAL OILS FOR RAILROAD USE.

### SIGNAL OIL CO.,

FRANKLIN, PA.

J. C. SIBLEY, President.



## THE NEW "NATHAN" (See Illustrat'n) AND MONITOR INJECTORS FOR LOCOMOTIVES.

"Nathan" Sight-Feed Lubricators

For Cylinders and Air Brakes.

STEAM FIRE EXTINGUISHERS for Switching and Yard Engines.

BOILER WASHERS, BOILER TESTERS, ROD AND GUIDE OIL CUPS, ETC.

### NATHAN MANUFACTURING CO.,

92 and 94 Liberty St.,

NEW YORK.

147 & 149 Van Buren st.,

CHICAGO.

## Galena Oil Co., FRANKLIN, PA.

CHARLES MILLER, President.

Galena Oils are the Standard Railway lubricants of America.

Galena Oils are used exclusively on nineteen-twentieths of the total railway mileage of the United States, Canada and Mexico.

Galena Oils lubricate the fastest trains of the world, and hot bearings as a result of defective lubrication are unknown to the patrons of the Galena Oil Company.

Galena Oils are manufactured exclusively by GALENA OIL CO.

Principal Office and Works:

Franklin, Pa.

# THE GRAVITY CAR COUPLER.

## AN ABSOLUTELY AUTOMATIC COUPLER.

### Cuts the Cost of the Vertical Plane Type in Two.

THIS COUPLER takes the ordinary Link.

Is always ready to couple.

Works on heaviest curves.

Gives a center draft.

Is compact, light and strong.

The latch cannot

jump up, or creep

up, and release link

by motion of the

cars.

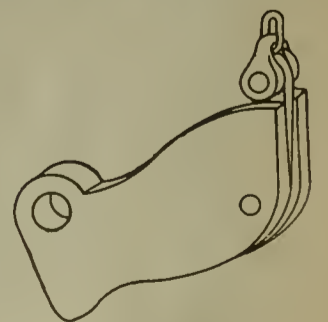

The Latch.

IT HAS STOOD THE SEVEREST SERVICE TESTS IN MOUNTAIN AND YARD SERVICE FOR MONTHS. WEIGHT, COMPLETE, 145 LBS.

NO PINS TO BUY.

NO KNUCKLES TO BREAK.

For details address

The Gravity-Car Coupling Co.,

Colorado Springs, Col.

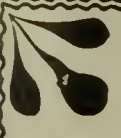



# The Westinghouse Air-Brake Company

is now prepared to fill orders at an hour's notice for one or one thousand sets of AIR-BRAKES FOR FREIGHT CARS, having at their new works an annual capacity for turning out air brakes for

**250,000 FREIGHT CARS**  
**6,000 PASSENGER CARS**  
**10,000 LOCOMOTIVES**

Besides repairs for the 650,000 freight and Passenger Cars and 33,500 Locomotives already equipped by



# The Westinghouse Air-Brake Company

# RAILWAY MASTER MECHANIC

WALTER D. CROSMAN, Editor.

EDWIN N. LEWIS, Manager.

PUBLISHED MONTHLY BY

THE RAILWAY LIST COMPANY.

Devoted to the interests of railway motive power, car equipment, shops, machinery and supplies. Communications on any topics suitable to these columns are solicited.

Subscription price, \$1 a year, to foreign countries \$1.50, free of postage. Advertising rates given on application to the office, by mail or in person. Address

THE RAILWAY LIST COMPANY,

The Rookery, Chicago, Ill.

The Official Railway List is Published by this Company.

VOL. XXI. CHICAGO, SEPTEMBER, 1898. No. 9.

THE article on German military railroading, contributed this month by Lieut. Otto Roedder, who is a graduate in the department of naval construction of a leading German university, is both interesting and instructive. We have just passed through a plentiful experience in being unprepared to transport armies to the points where they were needed, and the article indicates some of the things which it is necessary to do beforehand in order to be prepared for such things as soon as the necessity arises. It is to be hoped that this nation has at last got its eyes permanently opened and that it will profit by both its own experience and by the practices of other nations who manage to avoid war by being prepared for it. An abundance of men trained in all the details of warfare is the best guarantee of peace.

THE compilation of weights of couplers and parts of couplers made by Secretary Cloud of the Master Car Builders' Association is of interest and value. This compilation, which will be found in another column, covers all weight details of 36 different makes of couplers. Aside from its value, as relates to questions of weights, it possesses another point of interest in that it affords us a conveniently arranged list of coupler now in use—not complete, of course, but so nearly so as to serve a purpose as a reference list. Adding the number of those concerning which detailed information is given—36—to the number of those which failed to respond to the secretary's request for information—12—and we find that there are 48 makes of couplers which are within the official cognizance of our associated American railways. This seems like a dreadfully high figure to those of us who, in arguing for the adoption of the vertical plane coupler, urged that it was necessary to reduce the number of drawbars kept in stock for repairs. And now come the car foremen at Chicago and report that we have in interchange 75 or more different patterns of couplers and 88 different styles of knuckles. It is plain that the day must come when these figures must be reduced.

THE report of the August meeting of the Chicago Car Foremen's Association, which is given in full elsewhere in this issue, will be found to possess a peculiar interest. Through the medium of this report we are brought in close touch with the thought of the men who are daily in and about our interchange cars—the men "who are right down on the track," as it has been expressed. It is they who have the daily wrestle with the interchange rules, with half Nelson and strangle holds, while their superiors stand in the ring corners and watch. And it is they who will eventually make or break the rules. It is upon their daily experiences that their superiors draw when formulating new or altering old rules; but the latter base their action upon reports from many men at many points, and it is thus not surprising that when the "new" rules come back each year to car foremen and inspectors that individuals among the latter are not a little perplexed.

It will be noticed that the M. C. B. coupler re-

ceived a rather hard rap during this car foremen's meeting. One man said that the "M. C. B. coupler today is a failure." This bold statement found no antagonist; in fact, it was rather bolstered up in the course of the following discussion. Now this is a proposition that is easy to make, but exceedingly difficult to prove. The proposition that the M. C. B. coupler, on the other hand, is not a failure can be proved; in fact, it has been proved. The better way to put the matter would be to put it as Mr. Leeds did before the Central Association of Railroad Officers at Indianapolis recently. We give the substance of Mr. Leeds' peppery remarks in another column, wherein it will be seen that he says, in effect, that the vertical plane coupler does not meet all the requirements. This is, as we say, a better way to put the matter, and moreover it is a demonstrably truthful way. While no close observer will seriously admit that the M. C. B. coupler is a failure it must be conceded that it is not the ideal form of coupling. But, quoting again Mr. Leeds: "What are you going to do about it?" The fact of the matter is that the M. C. B. coupler is nearer right than anything known to date, and that it is unquestionably here to stay.

We considered this matter at some length in our issue of April, 1898, showing that there were errors of design and admitting that the remedy was difficult of attainment. But then, as now, we expressed the belief that it was madness to decry the M. C. B. coupler. The thing to do is seek a feasible plan for strengthening it and to insist upon better material. Meanwhile an increasing use of buffer blocks will to a large extent compensate for existing weaknesses in the coupler type.

## COMPOUND LOCOMOTIVES.

Had anyone predicted in 1890 or 1891 that it would require eight or nine, or more, years to determine what conditions of traffic could be more cheaply handled with compound locomotives than with simple locomotives he would have been considered, at best, a very poor prophet. Nevertheless such a prophecy would have been entirely fulfilled, and even after so many years it is yet a question in the minds of many officers as to just how far the compound locomotive can be used economically when the first cost, cost of fuel and cost of repairs, and cost of lost time due to the latter, are given due consideration. Attention is attracted again to the compound locomotive because quite recently orders have been placed for them by roads which, heretofore, have not been inclined to consider them favorably.

When the compound was first being considered there was much discussion as to whether the cost of repairs to it would be greater than the cost of repairs to the simple locomotive, and in the minds of some the question has not been decided yet, while for others it has been settled, apparently, sometimes favorable to the compound and possibly quite as frequently otherwise.

It is entirely reasonable to expect an increase in cost of repairs to compound locomotives, because every attachment or device added to the equipment must increase the cost of attention, but to just what extent such increase in cost will show in the records will depend upon the basis of such records, and also upon the basis of comparison, and upon the period in the service of each type which is taken for comparison. It is manifestly unfair to compare a locomotive of either type and on either basis with a locomotive built two or three years previous to it, because the former would have been built correspondingly stronger to handle the ever-increasing weight of train; and if the comparison is based on the engine mile record the inequality is even more pronounced. Records which are to be used for comparing compound and simple locomotives should be kept very carefully; the same number of each type, probably not less than ten, should be operated similarly on the same division of road, and the average loading of each should bear the same ratio to capacity of each in both cases. Moreover, those who work the compounds and those who have the care of them should be as familiar with the mechanism and the method of operation of this type as those are who handle the

simple locomotives with their type. This last is a consideration which is seldom fulfilled, if, indeed, even considered. This oversight, or neglect, affects unfavorably the records of compound locomotives; but, on the other hand, the general practice of taking for comparison the first year or two of service of the compound operates decidedly to the advantage of the latter. It is generally understood that the cost of repairs after about two years of service increases more rapidly for the compound than for the simple locomotives, and, while designers and builders have put forth strenuous efforts to overcome this difference, it is hardly to be expected that the rates of increase in cost of repairs can be made the same for both types. For this reason records from compound locomotives which are to be used for comparison with similar records from simple locomotives should extend over the period of the first four or five years of service, or should cover a period which shall include the cost of the first general repairs and a year or two of service after such repairs.

The compound locomotive has had much with which to contend and not the least obstacle has been prejudice. The greatest, however, has been ignorance—ignorance as to the methods of handling and caring for the type and ignorance as to the service suited for it. This ignorance has been shared by the designers and builders to no less degree than by the railroad men, and of course is due entirely to lack of experience. Lack of experience in handling and caring for the compound has been, probably, the direct cause of the reputation which this type has of being a "good shop engine," but it is a condition which was to have been expected and which, if entirely surmounted at all, must be overcome gradually.

Reference has been made above to the ignorance of the service to which the compound type is best suited, and it is believed possible to show that such ignorance is quite general. The opinion is all but universal that a simple locomotive, doing its work with the cut-off averaging from one-quarter to one-third the stroke, with uncovered cylinders and other arrangements as at present, cannot be improved upon very much by simply providing it with compound cylinders; in other words, when the simple engine works at a cut-off of one-half or a greater proportion of the stroke, it is working under conditions which favor the compound, and the fineness of the problem lies in determining the exact location of the neutral line where the simple and the compound can be operated equally advantageously.

In practice, no effort has been made to locate this line, contentment being reached in selecting such service in which it was supposed there could be most probability and most possibility that the compound would be most favored, and it is in the selection of such service that it is desired to raise question now. Judging from the class of service for which compounds usually have been selected, it has been the quite general opinion that they should give best results in mountain service; but while the compound is working more advantageously up the heavy grades, the simple locomotive runs down such grades under conditions just as favorable to itself, and works over the level track and lighter grades under conditions, possibly, just as favorable to it. The net advantage to either depends on the ratio of the heavy grades, in both directions, to the total distance both ways. It will follow from this that the conditions ideally favorable to the compound locomotive are those under which the simple locomotive is worked at about one-half cut-off, or greater, over the entire round trip run, and these conditions can be more nearly fulfilled on a level track with full loading in both directions.

The substantiation of much of the foregoing is found in the results obtained on the Lake Street elevated railroad, in Chicago, when it was operated by steam locomotives. The track was practically level; the traffic and service did not vary from day to day, but did vary during the day; the several locomotives of the compound and simple types were built at the same time and were identical except as to design of cylinders and the difference in machinery made necessary by the difference in cylinders. The evidence is most tersely presented by saying that after the experience of several months with both types, no simple locomotive was used when there was a compound available for service.

**HIRING LOCOMOTIVE RUNNERS.**

A very nice problem in ethics is that to determine whether a railroad should entirely provide itself with locomotive runners by promoting its firemen, or whether it should satisfy only a part of its requirements in this way and fulfill the remainder by engaging men from outside sources. If the latter plan be followed what should be the relative proportions of firemen promoted and of runners engaged from the outside?

It is the practice of some roads to provide themselves with locomotive runners by promoting firemen, and engaging no runners, as runners, except when there are no firemen available for promotion. This plan is certainly very encouraging for the firemen, even though some must wait five or six years for promotion; and if we look no further than this the conclusion reached would be that runners so obtained must be the most desirable because they are schooled in the practices of the road and are familiar with that part of the road over which they are to run. But if all roads were to do this what would there be in store for the fireman after he became a runner? If he loses his position, from whatever cause, his capital—his knowledge of how to run a locomotive—is made valueless and, practically, he must start again to accumulate capital of an entirely different kind.

Everyone is liable to make a mistake sometime, and runners may even lose their employment through occurrences over which they have no control; then if railroad are to employ no runners as such these unfortunate runners must begin again either as firemen or in other pursuits. This certainly presents an unsatisfactory outlook for the men, and it may be just as unfortunate to the railroad company, because such prospects will tend to make desirable men seek other callings, whereas it should be to the interest of the railroad to attract to the positions of runners the highest class of labor possible and in sufficient number to supply the demand. However, there is one very good feature which this system has, and which should not be overlooked: Railroads, like some other corporations, are reputed to be "soulless," but there are very few railroad officers who would not go to the last extreme before taking from a man his means of making a living. This manly consideration for the welfare of the employes would operate very strongly against discharge until gross neglect or incapacity was shown.

Under the system in which some of the runners are hired as such and some are obtained by promoting the firemen, the promotions are somewhat slower, but after the fireman becomes a runner his chances for continuing as such, either on the road where his promotion occurs or on some other road, is considerably better.

**MASTER MECHANICS COMMITTEES FOR 1898-99.**

The executive committee has selected topics for consideration at the meeting of the Master Mechanics' Association to be held in June, 1899, and has assigned these topics to committees. We append a complete list giving the personnel of the committees. It will be seen that the topics are not only well chosen but are happily assigned. The topics are practically those suggested by last year's committee on subjects:

- 1.—A Research Laboratory Under the Control of the Association.—Wm. Forsyth, W. F. M. Goss, John Player.
- 2.—The Best Methods of Preventing Trouble in Boilers from Water Impurities.—A. E. Manchester, J. H. Manning, S. P. Bush, H. Bartlett, R. M. Galbraith.
- 3.—Relative Merits of Cast-Iron and Steel-Tired Wheels for Locomotives and Passenger Car Equipment.—J. N. Barr, H. S. Hayward, A. M. Waitt.
- 4.—Advantages of the Ton-Mile Basis for Motive Power Statistics.—H. J. Small, C. H. Quereau, W. H. Marshall.
- 5.—Best Method of Applying Stay Bolts to Locomotive Boilers, Including Making the Bolts and Preparing the Stay Bolt Holes.—G. F. Wilson, S. M. Vauclair, T. A. Lawes.
- 6.—Is it Desirable to Have Flanged Tires on All the Drivers of Mogul, Ten-Wheel and Consolidation Engines? If So, with What Clearance Should They Be Set?—S. Higgins, W. H. Thomas, Wm. Garstang.
- 7.—Best Form of Fire Box to Prevent Cracking. Is it Advisable to Use One Piece for Crown and Side Sheets?—H. Monkhouse, T. R. Browne, B. Haskell.
- 8.—The Use of Nickel Steel in Locomotive Construc-

tion; Its Advantages and Proper Proportion of Nickel.—A. E. Mitchell, Pulaski Leeds, Tracy Lyon.  
9.—Subjects—R. Atkinson, John Hickey, G. R. Henderson.

**NEW MOGUL LOCOMOTIVE C. G. W. RY.**

The Chicago Great Western Railway recently had built by the Richmond Locomotive Works two locomotives—one simple and one compound. These engines, which have attracted some considerable attention, are now in service. Through the courtesy of Mr. Tracy Lyon, master mechanic of the Chicago Great Western, we are enabled to give an illustration of the compound, and to give a description of the simple engine, which description practically covers the compound also.

These engines are principally remarkable in being "over cylindered" according to ordinary practice. Their traction, based upon the mean effective pressure of 85 per cent of the boiler pressure, is equal to 28½ per cent of the weight on the drivers, and Mr. Lyon expects to develop on the maximum grades at least 30 per cent. The advent of the pneumatic sander has very materially changed the condition of affairs as to the relation between the traction of an engine which can be effectively developed and its

strongly braced design, and the trucks all of steel of the "Barber" type with elliptic springs.

Appended are the general dimensions of these engines:

Type .....	Mogul
Simple or compound.....	1 simple, 1 compound
Kind of fuel .....	Bituminous coal.
Weight on drivers .....	100,000 lbs.
Weight on truck wheels.....	20,000 lbs.
Weight total .....	120,000 lbs.
Weight tender, loaded .....	74,000 lbs.
Wheel base, total, of engine.....	23 ft. 1 in.
Wheel base, driving .....	15 ft.
Wheel base, total (engine and tender).....	48 ft.
Length over all, engine.....	34 ft. 7¼ in.
Length over all, total, engine and tender.....	57 ft. 6½ in.
Height, center of boiler above rails.....	7 ft. 10 in.
Height of stack above rails.....	14 ft. 7-16 in.
Heating surface, firebox .....	153.56 sq. ft.
Heating surface, tubes .....	1684.68 sq. ft.
Heating surface total .....	1838.24 sq. ft.
Grate area .....	28 sq. ft.
Drivers, number .....	6
Drivers, diameter .....	60 in.
Drivers, material of centers.....	main, steel, others, c. i.
Truck wheels, diameter .....	30 in.
Journals, driving axle, size.....	8 in.
Journals, truck axle, size.....	5½ in.
Main crank pin, size.....	5¾ in.



NEW MOGUL COMPOUND—C. G. W. RY.

weight; moreover these engines are particularly designed to meet the conditions to be met with on the Chicago Great Western. On that road they are limited for the present to the weight on the drivers of about 100,000 pounds within a wheel base of 15 feet, and while they have no very long or heavy grades, there are on each division one per cent grades of sufficient length to prevent the momentum of the train from being considered in getting over them. They are, however, sufficiently short so that from an operating point of view they feel that they can neglect entirely the question of time and may permit trains to crawl over the summit at a minimum speed.

These engines are therefore expected to take 950 tons between tender and caboose over any grades as fast as the company wishes to send it until the one per cent (compensated) grade is reached and then with the help of the pneumatic sand pipes in front of both the forward and main drivers, to get over the hill at slow speed with almost any sort of a rail, developing a traction, as has been said, equal to at least 30 per cent of the weight on the drivers.

The effort to bring the center of gravity of the boiler down as low as possible is very evident in the design, it being considered that this is of no mean importance to the track. In the effort to get every pound out of these engines that is possible, the equalizers between the main and back drivers, instead of being made with arms of equal length, as usual, are so divided that the additional weight of the main drivers is taken into consideration—this in order to make the weight on the rail of each pair of drivers the same instead of the weight on the journals. Mr. Lyon feels that it appears as though this is worth while if it will postpone the slipping point, even by a very small margin.

The tender is noticeable in the capacity of the tank, 5000 gallons, which is large for an engine of this size. The tender frame is of nine inch channels, with wooden end sills, of a particularly simple and

Cylinders, diameter... simple, 19; comp., 21 and 33 in.  
Piston, stroke..... simple, 28; comp., 28 in.  
Piston rod, diameter .....

.....	3¼ in.		
Main rod, length center to center.....	7 ft. 9 in.		
		Simple	Comp.
		H P	L P
Steam ports, length.....	20	20	23 in.
Steam ports, width .....	1½	1½	2¾ in.
Exhaust ports, length .....	20	20	23 in.
Exhaust ports, width .....	3	3	3 in.
Bridge, width .....	1¼	1¼	1¼ in.
Valves, kind of.....	Am. Bal. Slide		
Boiler, type of.....	Extended Wagon Top		
Boiler, working steam pressure.....	200 lbs.		
Boiler, material barrel, Acid Steel Am. M.M. Assn spec			
Boiler, thickness of material in barrel.....	.9-16 and 5/8 in.		
Boiler, diameter of barrel .....	58 in.		
Seams, horizontal.....	Double cover, Sextuple riveted.		
Seams, circumferential .....	Double riveted.		
Thickness of tube sheets .....	1½ in.		
Thickness crown sheet .....	¾ in.		
Crown sheet stayed with.....	1¼ in. Radial stays.		
Dome, diameter.....	31 in.		
Firebox, length .....	8 ft.		
Firebox, width .....	3 ft. 6 in.		
Firebox, depth front to grate .....	65¼ in.		
Firebox, depth back.....	53¾ in.		
Firebox, material.....	Firebox Flange Steel.		
Firebox, thickness of sheets .....	¾ in.		
Firebox, water space, width:Front 4; sides 3½ back 3½			
Grate .....	Shaking Finger		
Tubes, number .....	270		
Tubes, material .....	Charcoal Iron T		
Tubes, outside diameter.....	2 in.		
Tubes, length over sheets.....	12 ft.		
Smokebox, diameter .....	58½ in.		
Smokebox, length .....	61 3-16 in.		
Exhaust nozzle, single .....	4¾ in. diam.		
Tank capacity .....	5000 gals.		
Tender, under-frame .....	Steel.		

**SPECIAL FITTINGS.**

Tires .....	La Trobe
Axles .....	Cambria
Sight-feed lubricators .....	Detroit
Couplers .....	Tower

Safety valve .....	Crosby
Sanding devices .....	Leach
Injector .....	Hancock
Driver brake equipment.....	Am. Brake Co.
Tender brake equipment .....	Westinghouse
Tender brake beam .....	Kewanee
Air pump .....	Westinghouse
Engine truck, driving and tender springs.....	National Railway Spring Co.
Piston rod and valve, packings.....	Jerome

**A NEW PILE DRIVER—L. S. & M. S. RY.**

The Lake Shore & Michigan Southern railway lately built a pile driver that possesses many features of unusual interest. We are enabled, through the courtesy of Mr. Samuel Rockwell, engineer Michigan Southern division of that road, to present five views of this remarkable machine, together with descriptive notes which will afford an excellent idea of its design and its scope of work.

In designing this pile driver the problem called

the end it faces when the leads are first raised.

The reach was gotten by placing the center of the machine 5 ft. 6 in. from the center of the car, so that while ordinarily the leads work just clear of the drawbar, by revolving the machine completely around on the car the leads will face the other way, with an overhang of 16½ ft. from center of wheel, as shown in Fig. 4; and Fig. 5 shows a side reach of over 30 ft. from center of track it is standing on, and the pile driver is efficient anywhere within the full sweep of the circle.

The propelling gear is shown under the car, and is capable of moving the machine at a speed of twenty miles an hour with a train of two boarding cars and two to five, or more, cars of piles or other material, according to the grade of road it is working on. It also gives very prompt and quick movement to the machine itself in its regular work.

The principal dimensions are as follows:  
 Length of car body over all.....45 ft. 8½ in.  
 Length of leads.....36 ft.

The car was built by Mr. A. M. Waitt, general master car builder of the road, at the Cleveland shops. The machine was built complete at the engineers' department shops at Elkhart, and entirely from the original designs of that department. It has given the very highest satisfaction, and has attracted considerable attention wherever it has been seen by any one who understood what a pile driver should be.

The sixth annual convention of the Traveling Engineers' Association will be held at Buffalo, N. Y., commencing Tuesday, September 13th, at 9 a. m. The headquarters and convention hall will be at the Genesee House. Hotel rates will be \$2.50 per day each person. One-half rates have been secured by the Pullman and Wagner Palace Car Companies. The committees on subjects have been hard at work, and have prepared some excellent reports, and the committee of arrangements are leav-



FIG. 1.—PILE DRIVER—L. S. & M. S. RY.—READY FOR THE ROAD.

for a machine which, while a good, serviceable pile driver, must be a car when ready to travel on the road, and be capable of being coupled as such into any regular train and take its chances along with any other equipment. While it would be used principally on renewal work, and at such would work to better advantage with the leads close to the car, it must be capable of an extension for new work, washouts, etc., and also a side scope for work outside of the track. Moreover, as much of its work was to be done at a distance from a dodging track, and as it is necessary to use all available time on busy tracks, and as wires and other overhead obstructions are very often found between its working place and dodging track, it must be able to raise and lower its leads within itself, and in the very quickest possible time. Another feature to be met was, that as the engineers' department is independent of the operating department, and consequently always using more of their power than they can spare, the pile driver must have a self-propelling power that will constitute it a locomotive, capable of handling not only itself but to a very considerable degree its equipment of boarding cars and several cars of material, so that it will not ordinarily need a locomotive. Such was the problem to which the engineering department of the road addressed itself, with the handsome results as revealed in our engravings.

Figure 1 shows the machine as a car ready for the road. It has no projections beyond the regular drawheads, and can be coupled into any train and travel at any speed. The smokestack is turned down when ready for the road to give the car its least vertical clearance, but by neglect this was not done when our photograph was taken.

Fig. 2 shows the leads in process of being hoisted or lowered, and is self-explanatory. The whole performance does not take to exceed two minutes.

Fig. 3 shows the machine ready for work as it is most frequently used—i. e., whenever there is a track to carry it up to its work. In this position, it has the advantage of better leverage for holding it stiff sidewise; but really this is pretty nearly the only advantage, aside from the fact that it is

Weight of hammer..... 3000 lbs.

The hoisting engine has two cylinders, 6 in. with 12 in. stroke, and two friction drums, 18 in. and 12 in. respectively, and a nigger head. The propelling engine has two cylinders, 8 ⅛ in. with 12 in. stroke, working on one pair of truck wheels through steel gears. The boiler is 36 in. by 40 in. by 56 in. with 48 2-in. flues.

The machine has a tank holding about 500 gallons of water, and a bin holding about one ton of coal, which are convenient for use when temporarily clear of its tender, and also for adjusting the balance of the machine, although it has proved to be much stiffer in this respect than was feared. The weight of the machine ready for work is 107,650 lbs.

ing no stone unturned to make the visit at the beautiful city of Buffalo a pleasant one.

Labor troubles apparently date far back, for the deciphering of a papyrus in the Turin Museum, which is a sort of journal or day book of the superintendent of the Thebes necropolis, furnishes curious details of a workmen's riot, or trade dispute, which occurred in the ancient city in the reign of Rameses III. The workmen's quarter sent a deputation to the keeper of books and to several priests of the necropolis during the strike. The speaker of the deputation is reported as having said: "Behold, we are face to face with famine. We have neither nourishment, nor oil, nor vestments; we have no fish, we



FIG. 2.—PILE DRIVER—L. S. & M. S. RY.—HOISTING THE LEADS.

have no vegetables. We have already sent a petition to our sovereign lord, the Pharaoh, praying him to give us these things, and now we address the Governor in order that he might give us the wherewithal to live."

### GERMAN MILITARY RAILROADING.

BY LIEUT. OTTO ROEDDER, NAVAL CONSTRUCTOR.

In Germany every able-bodied man between 18 and 45 years of age owes military service. The control offices keep a record of every man subject to military duty, and these offices are located in all the principal cities of the empire. The total number on the rolls is about six millions. In time of peace each man serves either one or two years, the shorter service being assigned to all who have a certain standard of education.

When war is declared three days are given to each man, embraced in the call for soldiers, to settle his private affairs. On the third day he must appear at the nearest control office, to be either sent to the troops in garrison at that point or else forwarded to some other place of destination. Now begins the busy time for the railroads. So many men are to be taken to the regiments, and so many regiments with all their ammunition, horses, luggage, etc., are to be transported to the front; and at the same time the ordinary traffic of the roads must, if possible, not be interfered with. In order to facilitate these movements of troops the German government has elaborated a series of time tables which cover all movements to any point where the war department may desire to have an army suddenly concentrated. The details of these tables are carefully guarded secrets, but it is known that in the main office at Berlin prepared orders are kept ready to be transmitted by mail or wire without the delay of an instant, so that the regiments called out can be assembled in uniform, with their necessary baggage, at the railroad stations ready and waiting for the trains that are to hurry them to their destination.

Emperor William Second likes to give entirely unexpected alarms to the garrisons near where he may be staying; and I remember a case in my own experience when, in less than 30 minutes after the alarm was given by trumpet signals, our entire regiment was standing in parade ready to march on the drill grounds, which were at least ten minutes distant from the armory hall. This is what is meant in Germany by "readiness for war."

The cars in Germany are built in compartments, having from five to seven, each with an outside door. This system is very handy for military purposes, though it is gradually being abandoned because it does not meet the demands of the public.

Every car has its capacity marked on the box or truck. For example: "F. M. T. 40M. 6Pf." means "Military Transport; 40 men or 6 horses." The cars which are used either for horses or men are fourth-class cars which have only one seat, which is placed lengthwise of the car. The ordinary third-class cars carry in each compartment eight men fully equipped with musket, knapsack, tent and pick. The men are sometimes a little crowded in these cars, but a good

government, but men must be trained for such special work.

Along the line of the Berlin-Roederau-Dresden railway runs another railroad which is known as the "Military Railroad." It extends from Schoeneberg, which is near Berlin, to Rangsdorf, a distance of about 20 miles. This road is managed by the famous Eisenbahn, or railroad, regiment, and it is on it that the officers and men get their train-

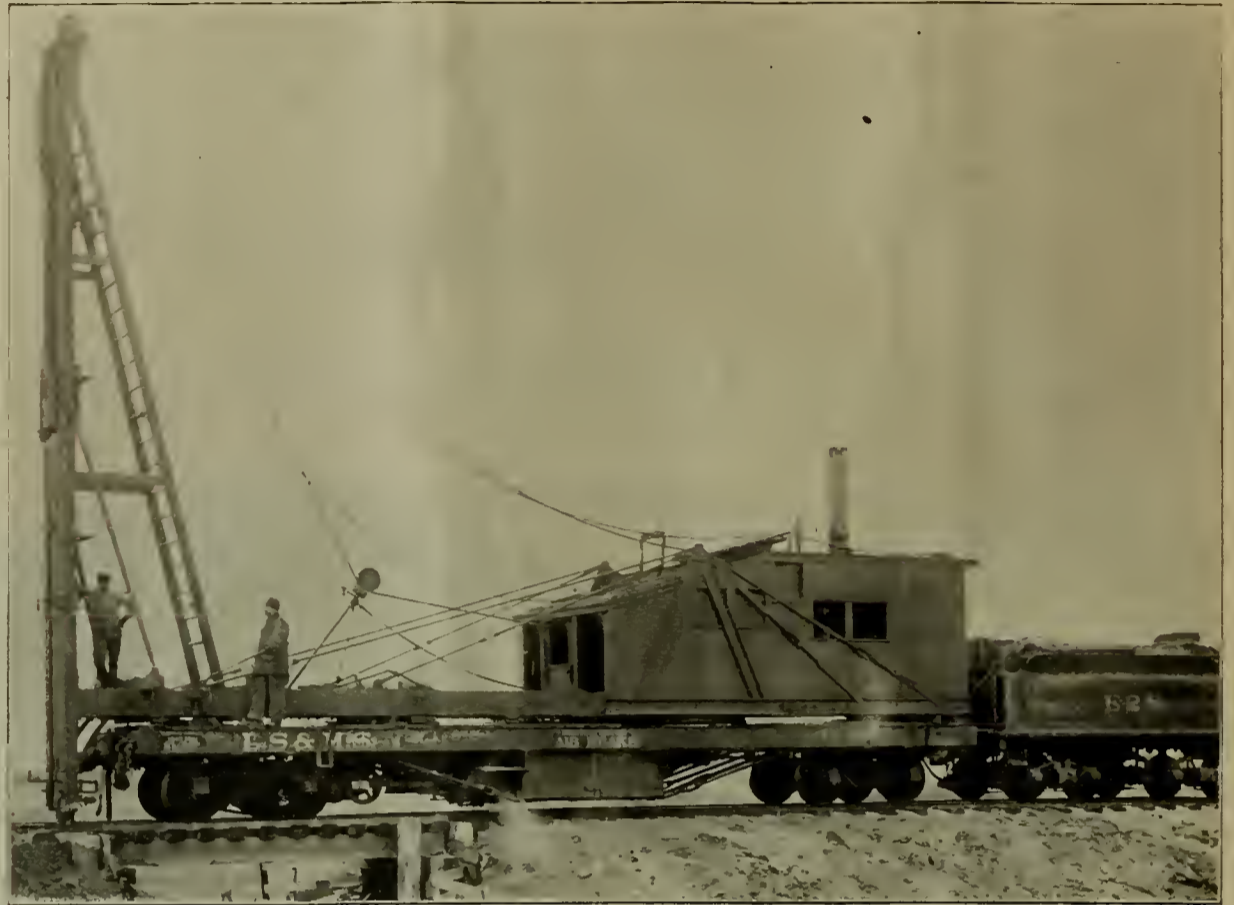

FIG. 3.—PILE DRIVER—L. S. & M. S. RY.—USUAL WORKING POSITION.

soldier never loses his humor, and the bystander, hearing their merry songs, can easily believe that they are enjoying their quarters and having a good time. The second and first-class cars are for the use of officers, and have sleeping accommodations.

Where does the government get the trained men, such as conductors, depot-masters, operators, etc., to meet these sudden demands caused by the vast increase in the movement of trains? It is easy to get the cars, for the roads are all owned by the

ing. The Eisenbahn brigade, or military engineer corps, consists of two regiments, and its purpose is not only to train a class of men who will be good fighters but also to drill them in all the technical and practical knowledge necessary to make them expert in the construction and operation of railroads. Their instruction extends still further, for they are taught how to destroy, as well as to build and operate, railway lines in war. This brigade furnishes the men necessary, in addition to the ordinary force, to run the hundreds of extra trains required when armies are suddenly called into the field either for war or for the great annual maneuvers of the German armies. The officers of the regiments are usually given such positions as depot masters, traffic agents and district managers. The non-commissioned officers are made conductors and engineers, and the ordinary soldiers are used as gatemen, brakemen, firemen, telegraph operators, etc.

This military railroad is open to the use of the public, but it is rather more interesting than pleasurable to ride on it. Being an experimental line many different kinds of rails, ties, and even road beds, are used in its construction in different places along the line. The passage from wooden to steel ties and vice versa is noticeable even by a layman.

In order to train these soldiers in building railroads an additional line is built every year, usually from Berlin to Jueterbog, about 20 miles, at the time, usually, of the great gun and shooting tests on the heavy artillery grounds at Jueterbog. The Eisenbahn brigade is required to build this road within a given time, just as though it were in time of war. During the construction of the road, and while it is being run, everything is conducted as though in war. There are the outposts; there is the camp for the soldiers; a telegraph is built; and all material for road and camp, including bridges, etc., must be hauled over the line under construction from the main storage depot in Berlin. All this makes the work very interesting and it is watched by a great number of officers from many nations. After it is built the whole line is tested; the heavy guns are taken out over it and returned, and then the line is taken up. A different set of soldiers does this work each year. In this way the whole

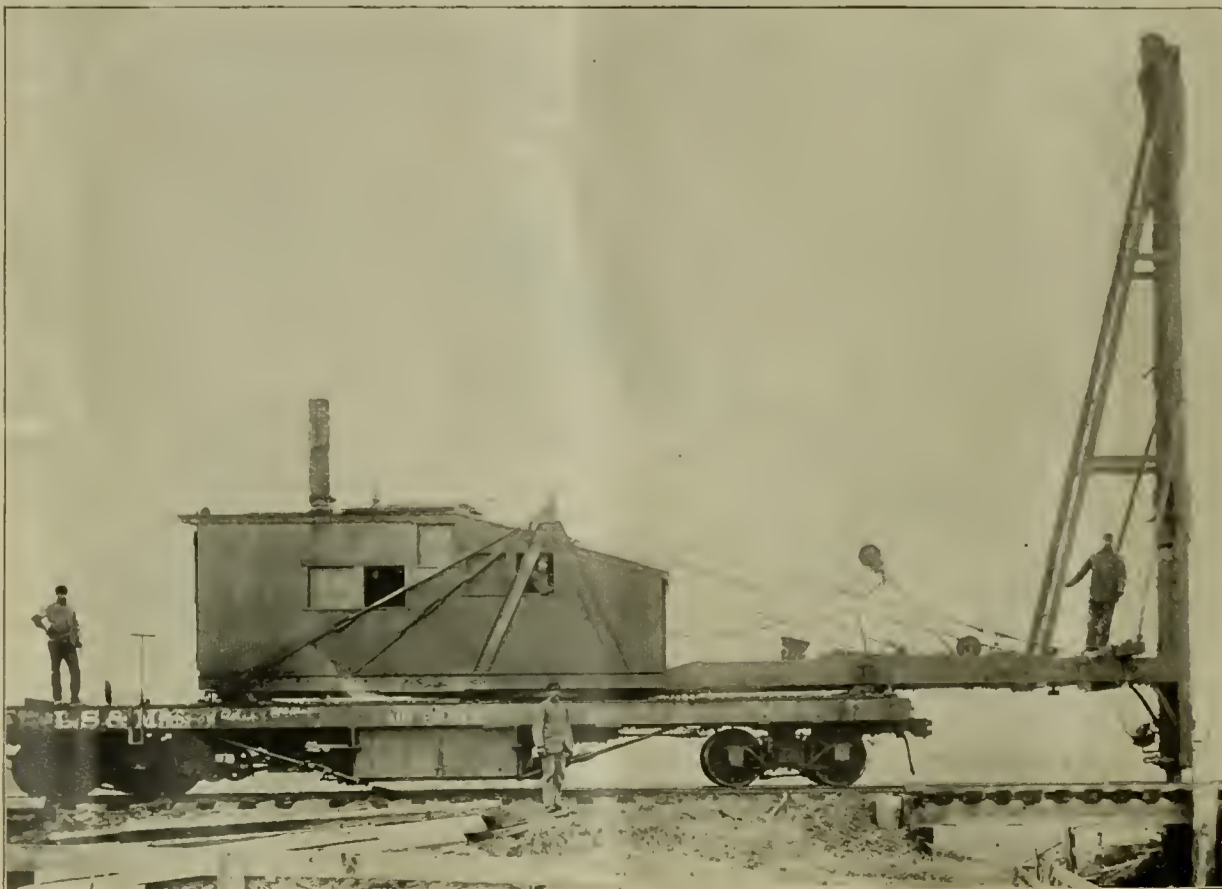

FIG. 4.—PILE DRIVER—L. S. & M. S. RY.—WORKING WITH 16-FT. OVERHANG.



brigade becomes familiar with all the details of building, operating and destroying railroads.

In addition to the work above described the Eisenbahn regiment has received and executed a good number of contracts with private parties on different roads. This is occasionally done when there is an unusual press of ordinary business.

The material used in the bridges of these annually constructed lines is wood or metal but never brick. The wooden bridges are almost exact copies of our American trestle work. Steel cables are drawn across the river, or other place to be bridged, and are stretched by means of hydraulic pumps. After the bridge is completed the cables are withdrawn and can be used again in some other place. The bridges are, necessarily, very strong, and vary in length from 20 to 100 metres. In the main, they consist of one or more single or double parabolic girders with wooden pressure and steel tension rods. The tops of the girders are made of wood and carry the cross ties. The details of the construction are kept as a military secret and therefore cannot be discussed or criticised. Many systems of bridge building have been tried by the chief constructing officers, and improvements are made every year. After completion they are tested by loading them down with locomotives and iron-loaded cars. Accidents occur very seldom, and although some have happened, they are not as numerous as in similar dangerous work carried on by private industry.

**CAR FOREMEN'S ASSOCIATION OF CHICAGO.**

**AUGUST MEETING.**

The Car Foremen's Association of Chicago held its regular monthly meeting at the Great Northern Hotel, on the evening of August 11, 1898, the meeting being called to order by President Hunt of the P. F. W. & C. Ry. There was a large attendance. Among those present were:

- |                    |                   |
|--------------------|-------------------|
| Alderson, A. S.    | Kroff, F. C.      |
| Blohm, Theodore.   | Larson, Alfred.   |
| Callahan, J. P.    | Manthey, H. H.    |
| Canfield, L. T.    | Morris, T. R.     |
| Coleman, J.        | Nordquist, C.     |
| Cook, W. C.        | Olson, Louis.     |
| Curran, John.      | Saums, C. L.      |
| Dair, Wm.          | Schimeck, J.      |
| Davies, W. O., Jr. | Schonberg, Chas.  |
| Depue, Jas.        | Schaltz, August.  |
| Gradel, Michael.   | Sharp, W. E.      |
| Grieb, J. C.       | Smith, E. B.      |
| Groobey, George.   | Smith, R. G.      |
| Guthenberg, O.     | Smith, F. H.      |
| Gutheuberg, Bruno. | Stocks, Jas.      |
| Haltz, Chas.       | Stuekie, E. J.    |
| Harkenrider, J. M. | Thiel, J.         |
| Haltz, Chris.      | Thiel, George.    |
| Hunt, T. B.        | Thirenge, J. C.   |
| Johannes, Albert.  | Trexler, Albert.  |
| Johuson, Gus.      | Waughop, Chas.    |
| Johnson, George.   | Wensel, G. F.     |
| Jones, R. R.       | Wensley, W. H.    |
| Kamen, Fred.       | Wharton, R.       |
| Kennicott, Geo.    | Williams, Thomas. |
| Kuhlman, H. V.     |                   |

The roll call and reading of minutes were omitted.

Secretary Sharp presented the name of 23 new members which had been passed upon by the executive committee, and approved by them. They are as follows:

**New Members.**

J. N. Barr, J. J. Hennessey, Jos. C. Grieb, Albert Johannes, Chas. Haltz, Thomas Williams, R. G. Smith and Chris. Haltz, all of the C., M. & St. P. Ry.; J. Mattes, F. C. Kroff and Jacob Schimeck, of the Pennsylvania Company; James Stocks, Michael Gradel, M. Fitzgerald, Alfred Larson, Geo. Johnson, O. Guthenberg and Wm. Dair, all of the I. C. Ry.; E. J. Stuekie, of the A., T. & S. F. Ry.; J. M. Harkenrider, M. Gehrke and W. H. Wensley, of the C. & Erie Ry.; and Albert Trexler, of the C. & A. Ry.

President Hunt: I am sure all members will be pleased to see the association growing in this way, and hope it will continue. The executive committee have presented a report, which the secretary will please read.

**Executive Committee's Report.**

To the Members of the Car Foremen's Association: The committee appointed at the May meeting to arrange for the printing of the proceedings reported to the executive committee that they were unable to arrive at a decision, in regard to the best method of procedure, and requested that the matter be taken up by the executive committee. This was done, with the result that the executive committee have arranged with

Walter D. Crosman, editor of the Railway Master Mechanic, to publish the proceedings in the Railway Master Mechanic.

Thos. B. Hunt, R. Wharton, W. E. Sharp, T. R. Morris, Chas. Dean, R. R. Jones, J. P. Callahan, Executive Committee.

The above report was, upon motion, approved.

**Encouragement from the Higher Officers.**

Secretary Sharp: The following communications relative to attendance of representatives of various lines at meetings of this association were received by me as result of a circular letter sent out by Mr. Beecham of the C., M. & St. P. Ry., to the different heads of transportation departments and by them referred to the various heads of mechanical departments.

[These letters were very encouraging in tone, as the following extracts from some of them will show]:

From a superintendent of car department: "I heartily concur in the object of your meeting, and assure you of my kindest regards and best wishes for its success. I will instruct our foreman at Chicago shops that it is the desire of this company that they attend and contribute to this meeting as far as it lies in their power, which must eventually result in good in advancing the interests of this company. Kindly advise me of the next meeting, as I will be glad to attend."

From a master mechanic: "Will you not kindly notify our foreman when these meetings will take place? I believe this will be of great benefit to him, and also to our company, in his getting familiar with the M. C. B. rules. I would be glad to have Mr.

wrong, and it is wrong in a way that cannot be modified. From my personal observations of the coupler, I would say that if the Master Car Builders had allowed at least an inch more space in the contour lines, allowing the manufacturer of the coupler to add more to the face of the knuckle and the lug of the coupler, it would have been far preferable to what they have now. The manufacturer can put as much metal as he likes in a coupler to-day, and if he lives up to the contour lines of the coupler as adopted by the Master Car Builders, I don't care what the coupler or knuckle weighs—if it weighs 32 lbs., the lightest of them, or on up to 70—he cannot get any more in the lug of the knuckle. The breakage of the guard arm is very great. My idea of a coupler, personally, is not a coupler with the head, well I say the head, cast to the shank of the coupler. That is wrong. In curving with the Master Car Builders' coupler, as they have now made them, I find that the lateral strain on a car is very great. It not only affects the car itself, but it is a great detriment to any car roof, on account of the lateral motion that is put on the car. If that lateral motion could be done away with, I think you will find that the car itself will wear at least five years longer. That is all I care to say on the coupler.

As to the Master Car Builders' rules, I would give this association the privilege of asking any question on the new rules of interchange, and I would be pleased to answer it, from the standpoint of a chief joint inspector.

Pres. Hunt:—Mr. Waughop, would you object to



FIG. 5.—PILE DRIVER—L. S. & M. S. RY.—WITH 30-FT. SIDE REACH.

Morris arrange to mail me copies of the minutes of these meetings. I get the minutes of the meetings of the Car Foremen's Association at Indianapolis and Cincinnati and always find them very interesting."

From a general superintendent of motive power: "I have instructed our superintendent of motive power to have our local general car foreman attend these meetings whenever possible."

From a superintendent of car department. "I have always encouraged our men to attend such meetings, as I think they tend to a better understanding, and the better people are acquainted at points of interchange the better it is for railways."

From a superintendent of car service: "If you will kindly notify our foreman when these meetings will take place, our company will be represented. Our master mechanic in charge of the Chicago division would also like to get copies of the minutes of these meetings."

**The M. C. B. Coupler.**

Pres. Hunt: We are now under the head of new business. Mr. Chas. Waughop, of St. Louis, has promised to give us a discussion on the M. C. B. coupler. We will be pleased to hear from Mr. Waughop

Mr. Waughop:—Under date of the 8th I wrote you that I would touch very lightly on that subject, as I believe that the rules are much more important to our section and also to your section than that subject. The M. C. B. coupler to-day is a failure. There is a coupler which I could name, but which I won't, that in my idea, from the standpoint of a car man, would overcome many objectionable features in the present M. C. B. coupler. From the standpoint of a car inspector the Master Car Builders' coupler is radically

any question on a coupler from any of the members, or on the remarks made by you this evening?

Mr. Waughop:—I would make no objection, except as to name of coupler.

Pres. Hunt:—While we are on the coupler, has any member anything to say in the matter of M. C. B. couplers, either from their own standpoint or taking any exceptions to Mr. Waughop's words? The M. C. B. coupler is a very important part of a car to-day. We would like to hear from some member; it might bring out some points that would be interesting to all of us.

Mr. Waughop:—I would call your attention to Rule 3, Section 29, of the new rules, page 13:—"M. C. B. couplers not equipped with steel or wrought iron knuckles." What are your members going to do with a coupler equipped with malleable iron or semi-steel knuckle offered in interchange?

Secy. Sharp:—I would like to ask a question. How are they going to find out that it is a semi-steel knuckle? I believe that will answer it.

Mr. Waughop:—There is only one man in the country who can name them from the standpoint of looking at it. I won't mention his name. I will state for the benefit of your association that we will give our inspectors on an average twenty minutes to inspect fifty cars. We will pay them \$60 a month. We cannot expect men with brains enough to know the difference between a wrought, steel or malleable iron knuckle, when it is painted, for that salary. We are going to pass these cars at St. Louis, without any question.

Mr. Canfield:—I would like to take exception to Mr. Waughop's remarks with regard to getting men with brains enough at that salary. Now we have

good men working in Chicago for a small salary. I would like to have him modify that word "brains."

Mr. Waughop:—I don't modify anything I say. You cannot hire brains for \$60 per month capable of demonstrating the difference between the three metals on sight, when painted; in fact, I doubt very much whether a metallurgist would know the difference, painted. We know that we have got as good inspectors as anybody in the country. We don't question their brains, but they are not capable; personally, I am not capable—I get more than \$60 per month—to tell the difference on sight. It is not a question of brains so far as inspecting is concerned. I do not cast any reflections on the inspectors. It simply is that they cannot—even the master car builder, himself, or the master mechanic, or the superintendent of motive power, hasn't the brains to do the thing, and yet he expects us to do it, according to that rule.

Secy. Sharp:—I would like to say, from my understanding of the discussion at the convention, that section was left in the rules simply as a preventative. It was argued that the so-called semi-steel was even a better metal for a drawbar knuckle than the steel that we are now using, but for fear that some railroad company or some other company would apply a cast iron knuckle, which they had the privilege to do, if this section were left out of the rules, it was put to a vote at the convention and the ruling was that that section would be left as it was in last year's rules.

There is a question I should like to ask Mr. Waughop concerning one of the points I expected he would touch on, and that is, the breakage of knuckles. Isn't it a fact that this is due more to the different makes of couplers rather than the material used? For example: We have 73 different patterns of couplers (I don't know but that we have more), and 88 styles of knuckles. Some of the couplers have two knuckles, that is, some of the makes of couplers (there are two or three sizes) have different sized knuckles that are not interchangeable. Isn't that feature alone going to be dangerous? Isn't it getting back to even a poorer coupler than the old style link-and-pin drawbar? I would favor very much a standard M. C. B. coupler; but if we have 75 different kinds of M. C. B. couplers we will surely meet some objectionable features.

Mr. Waughop:—I would say, from personal record, that the breakage of the knuckles is not caused nearly so much by the different patterns as is supposed—I will modify that—they don't follow the contour lines as laid down by the Master Car Builders. That feature has nothing particularly to do with the breakage of the knuckles. The breakage of the knuckle is caused by coming in contact with link-and-pin drawbars, and I would say that, from record, 75 per cent of the breakage of knuckles is caused by the link-and-pin drawbar, and directly on the upper lug. Generally speaking, there are about 75 or 80 kinds of knuckles. Let me quote a certain master mechanic on a St. Louis line who thought it was a good idea, owing to the fact that they had a great many delays on their line of cars on account of broken knuckles, to equip each of their cabooses with the different kinds. He said that the surplus revenue derived by the company was not sufficient to fulfill the recommendation; consequently they laid down on it.

Pres. Hunt:—Any experience of trains coming uncoupled from the use of M. C. B. couplers?

Mr. Stuckie:—We have fruit line cars on which, after making one round trip to California, the knuckle is worn out. Nearly 80 per cent of the fruit line cars are in that shape after making a round trip to California and back.

Mr. Waughop:—Is this on the inside face?

Mr. Stuckie:—It is on the inside upper lug.

Mr. Canfield:—What kind of material is in that knuckle that wears out so quickly?

Mr. Stuckie:—It is supposed to be a steel knuckle.

Mr. Canfield:—It must be malleable iron that causes it to wear out so quickly. The metal on the inside is rotten and will wear away very fast. If it is malleable iron I don't wonder at it wearing out so quickly. I don't think it would occur with wrought iron, and don't think it would occur with a steel knuckle; at least that has not been my experience.

Mr. Davies: We notice the same thing on C. F. X. cars that run to California. The cars that run to California came back in the same condition with the inside face worn.

A Member:—Are they malleable iron?

Mr. Davies:—Steel knuckle.

Pres. Hunt:—Do you find that on other cars?

Mr. Davies:—We do not find nearly so many. The shank will be worn out rubbing on the carrier iron. I have seen them worn through.

Mr. Waughop:—I would like to comment on that from my standpoint. It is immaterial what the quality of the knuckle is, whether it is made of malleable iron, wrought iron or steel. If that is the condition of the knuckle on anybody's coupler, I don't care whose it is, going to New York, or California and return, it is the chafing that causes it to wear out. It seems to me it would be a good idea to call the attention of the transportation department to the manner of keeping up their track. It is not the fault of the coupler; it is the fault of the track.

A Member:—If this is true, it would wear all knuc-

kles alike. I am inclined to think it is partly the quality of the knuckle.

A Member:—We have steel knuckles in passenger cars that are 50 feet long over the end sill, making them 60 feet long over the coupler. We have run them twelve months without changing the knuckle—200 miles a day, excepting Sunday. There are other cars running in the same service, and no doubt there are knuckles that are making better mileage than that. I think it is simply due to the better quality of material.

Mr. Waughop:—We handle everything, and I find that the wear of the chafing on anybody's knuckle is about the same. It is not a question of better material. I do not care what knuckle it is, it is not the fault of the coupler or knuckle, it is the fault of the track. If the track was level there would be no chafing, and consequently no wear on knuckle.

Mr. Davies:—My idea is that the wear on the inside face of the knuckle is due, not only to the track, but to the moving up and down of the cars on the springs. If you stand by the side of a train you will notice the cars springing all the time.

A Member:—Has this been noticed on cars other than those that run to California and back?

A Member:—I know that any coupler that runs will do it. I have seen them all. The wear all comes from the motion of the car.

Mr. Canfield:—The up and down motion no doubt causes wear on the knuckle, and we are also willing to admit that the track as well as the springs assist in furnishing the car with that motion; but why is it that one knuckle will wear out on one trip and another knuckle don't, in the same service? The point I want to get at is, that if one knuckle will last but a round trip, and another knuckle in the same service will make two round trips, or three or four, there must be something wrong in the material of the first knuckle mentioned.

Pres. Hunt:—It would seem that a knuckle made of good material ought to run longer than that. Indeed, if it don't it would be very expensive in the maintenance of the cars. I suppose that would mean a knuckle a month to each car. Of course I think there are various conditions that come in there that would cause a knuckle to wear—motion of the car on the springs, track and possibly the quality of metal. After a car has run awhile the bar gets a good deal more vertical motion than it had when it started, the carrier iron gets bent and it gives the bar lots of play—lots of room to work up, and I think that all these conditions come into play. But I cannot see why the same thing ought not to be on all couplers over the same tracks.

A Member:—I will cite a little incident that occurred on a certain western railway. There was a lot of 50 cars with new couplers, on one of the divisions of the road, and the first trip they made over the road the conductor complained of uncoupling—that he could not possibly keep these cars coupled—and they were all ordered to the shop, and they went over them carefully and nothing wrong could be found with them. They were made by one of the principal coupler companies in the country. So they let them out again with the same result—complaint of them coming uncoupled. They were finally ordered back to the shop and the new couplers were taken out and old ones put in. That stopped the complaint of the new cars coming uncoupled. They now had the new couplers on hand and didn't know what to do with them. By and by they again put the new couplers in old cars. After that I never heard any complaint of them coming uncoupled. They were no doubt in the wrong cars; that was what was the matter with them.

Pres. Hunt:—You never found out why they came uncoupled?

A Member:—No, sir; they never found out.

#### Publication Committee.

A recess was here taken, and upon reassembling Mr. Morris stated that the getting of the proceedings ready for printing was too much to ask of the secretary, and he therefore moved that a publication committee be appointed. This motion was adopted, and the president appointed the following committee: T. R. Morris, chairman; R. W. Barnett and W. E. Sharp. In connection with publication matters, Mr. Morris stated that the proceedings would be published in the Railway Master Mechanic only.

#### Provision for Annual Meeting.

Mr. Callahan then stated that there was only two months before the annual meeting and that the association ought to arrange for some kind of a celebration at that time. He therefore moved that a committee of five (to include the president) be appointed to arrange for the annual meeting. The motion was carried and the president appointed the following committee: W. H. Wenstey, G. W. Showers, W. O. Davies, Jr., E. B. Smith and T. B. Hunt.

#### The New Interchange Rules.

Pres. Hunt:—We will now have a discussion on the M. C. B. rules. There is a committee on the rules. Will the chairman read his report?

Mr. Davies:—Mr. Chairman: Your committee is very sorry to have to report that they did not quite complete this work. There was no chairman appointed at the last meeting, consequently there was

no one to call a meeting, and everybody was waiting for each other. The committee finally got together last Tuesday morning, but then it was too late, so we have merely got the additions to the rules of '97.

[Mr. Davies here read the report section by section, and discussion was had at intervals, as below reported.]

#### Rule 3, Section 1.

Mr. Davies:—There is a sentence added to this section, which reads that "M. C. B. defect cards should be printed in red ink on both sides."

Mr. Waughop:—That was put in for the purpose of distinguishing between a repair card and a Master Car Builders' defect card.

Mr. Morris:—Does it mean arbitrarily that they shall be printed in red ink? It says they should be.

Mr. Waughop:—That was discussed considerably at the convention, and the word "should" was substituted for the word "shall," for the reason that a number of roads have Master Car Builders' cards printed in black. They shall be printed, after the cards in stock are used up, in red ink.

#### Rule 3, Section 2.

Mr. Davies:—The words "leaving flat spots deepest at the edge, with raised center" are left out in the rules of 1898.

Pres. Hunt:—Did you say that in the opinion of the committee on rules the rule is correct? Your opinion is that it included shelled spots?

Mr. Davies:—I omitted reading that last sentence. (Reads from report): "And your committee is of the opinion that wheels shelled out from any cause are an owner's defect."

Mr. Morris:—From what cause could wheels shell out except from a defect in casting?

A Member:—When they are slid flat.

Mr. Morris:—Wheels that show defect on account of sliding are not shelled out. They are "comby from sliding." There is a difference between the two. A shelled out spot is a defect that is caused by a flaw in the casting, and nothing else, as I understand it.

Mr. Davies:—The committee discussed that quite thoroughly, and they decided that the words "leaving flat spots deepest at the edge" was to mean that any kind of a comby wheel, whether comby from sliding or shelled out, or any of these defects, would be considered owner's defect. A wheel comby from sliding would not leave spot deepest at edge; so they have left these words out in the rules so that they would cover everything.

Mr. Morris:—I would like to ask if anybody who attended the convention can give us any light on that; what their idea was in leaving out the description of the spot.

Mr. Waughop:—I have never yet seen a slid shelled spot on a wheel. I have seen shelled spots on a wheel, but not from sliding. I do not know the position taken by the Master Car Builders on that point, but I believe your recommendations would cover the point. That is their idea, that any shelled wheel should be considered car owner's defect.

Mr. Davies:—Is there nothing in the rules stating who is responsible for wheels comby from sliding? I think this is the best way out of it. There is always trouble on that score.

Mr. Morris:—The owner of a car is not responsible for a wheel that is slid, that is, slid by a road other than the owner; but a shelled out wheel is certainly an owner's defect. It would be wrong to charge an owner for a comby wheel that has been slid by some other road and not removed, but allowed to run until it got comby in that way, and I do not think we ought to recommend that comby from sliding be included in the term "shelled out."

[An effort was made by Mr. T. R. Morris to have definite action taken on this question, as well as upon other points in the rules that were discussed, but the president ruled against it.]

#### Rule 3, Section 12A.

Mr. Davies:—This is a new section entirely and reads: "Chipped flange, if the chip is on the outside of the flange and exceeds 1½ inches in length and ½ inch in width, or if it extends ¼ inch past the center on the flange, the owners are responsible. If chip is on the throat side of the flange, the delivering company is responsible."

Mr. Waughop:—From our standard west of here, it is universally known that Rule 3, Section 12A, is the inside of the flange. If you will turn over to page 9, you will find that wheels are out of gauge when they are more than 4 feet 5½ inches between flanges on what we term generally, always, in fact, the inside of the flange. We will have to turn over and call it the inside. Rule 12A is a plain rule. Section 14 of the same rule is also very plain; simply a question of what is the inside. But it has generally been known on our line as the outside. We will simply have to turn over and call it the other way.

#### Rule 3, Section 15.

Mr. Davies:—Seamy journal is added to this section. Owners responsible.

#### Rule 3, Section 20.

Mr. Davies:—The words "except on cars offered in interchange" are added. In the note under this section the following items are added: Cut-out cocks, triple valves and release valves. Your committee is of the opinion that this note is also intended to cover

missing triple slide valves and pistons, graduating stems, nuts and springs.

Mr. Waughop:—This rule, from our standpoint, will mean that any car offered in interchange with any missing part, fair or unfair, is cardable. As to the triple valve and parts, noted by the gentlemen on the committee being a part of the triple valve, it necessarily means if that is missing that that becomes "a delivering line responsible."

Mr. Morris:—How would the words "defective," "missing" and "worn out" be explained? Owners responsible for defective, missing or worn out parts of a brake? That seems to be a new departure altogether.

Mr. Waughop:—I would like to explain that this way: That rule was put in there simply as a penalty on the delivering line for not keeping up the foreign car. It is your duty, gentlemen, to repair any defective, missing or worn out part of a brake on a foreign car on your line, and you can charge it to owners. If you offer it in interchange, the penalty attaches; that is, you must pay for it.

Mr. Morris:—Then with a worn out brake shoe on a car offered in interchange the owners are not responsible. The delivering line is responsible?

Pres. Hunt:—Rule 20 says owners responsible, don't it, for defective parts?

Mr. Morris:—Except when cars are offered in interchange.

Mr. Davies:—These words, "except on cars offered in interchange," I believe would cover everything, every part of a brake, whether worn out or missing. I think the delivering company would be responsible for a worn out brake shoe on a car.

Mr. Morris:—There is no doubt about what the section says. The question is as to the spirit of it, and whether it conflicts with other rules or not.

Mr. Waughop:—I would like to refer back to the preface. "These rules make car owners responsible for, and therefore chargeable with, the repairs to their cars necessitated by ordinary wear and tear in fair service, so that defect cards will not be required for any defects thus arising."

"Railroad companies hauling cars are responsible for damage done to any car by unfair usage, derailment or accident, and for improper repairs made by them at their own expense, or issue defect card covering all such damage or improper repairs."

That preface simply covers all defects caused under fair usage not specified in the rules. They go to work in these rules and specify that if you don't keep up owner's cars while in transit on your line, you are responsible; and if you do keep it up, you can be reimbursed. If you are negligent in not keeping up the owner's car, then you must pay the penalty. It is simply a penalty attached to the rules to force the delivering line to keep the car in good repair. That is all it is for.

Mr. Sharp:—I would like to ask a question in regard to that. I will confess that I do not understand the rule as it seems to be here. There is a question now, in my mind, whether that rule means what it says. If it does, how about the cars that we transfer? For example: If we receive a Chicago, Milwaukee & St. Paul car from the Belt Line Railroad, and have it in our yard but a few days, and it is transferred and goes back with a worn out brake shoe, have we got to add on the extra expense of car inspection taking records of all such defects?

Mr. Stocks:—The way I understand that is this: If you offer a car in interchange and there is a brake shoe missing, the delivering road is not responsible for that brake shoe, but the receiving road can compel them to put a brake shoe on before receiving the car; and you can put it on and charge it to the owner of the car.

Pres. Hunt:—Well, I don't know. Suppose the car is delivered. If the car is delivered you are not in position to put it on. The car might be miles away from you.

A Member:—The car is not delivered until received. If a car inspector refuses a car it is not delivered yet.

A Member:—If you offer me a car with a worn out brake shoe it is my business to make an exception to the car right there.

Pres. Hunt:—You would not want to send a car back; hence you make repairs and charge owners of the car.

Mr. Smith:—I would like to ask if there is any car inspector in this room who has ever been asked for a defect card for a worn out brake shoe. If he has, I would like to have him stand up. (No one stands up.)

Mr. Davies:—There will be after September 1st.

Mr. Smith:—There ought not to be.

Mr. Waughop:—I am working, or, rather, you are working, under a big disadvantage. At St. Louis a car cannot be sent back, no matter what may be its condition, to the delivering line, except by order of the chief joint inspector. The chief joint inspector will card that car for a worn out brake shoe, regardless of whose it is.

A Member:—What is the matter with the chief joint inspector repairing it?

Mr. Waughop:—It is your duty to repair that car

and charge it to the owners. I will put that penalty on you to teach you a lesson.

A Member:—There is no doubt that a brake shoe becomes worn out at some point after passing the last repair station, and is worn out when it goes to the railroad it is to be delivered to. It looks unfair to have to card for something that is owner's defect.

Pres. Hunt:—There seems to be a good bit to this rule. Now, under this head any brake has failed under fair usage and the car is delivered to another company in that condition, if the company that receives the car elects to make these repairs, he must charge it to the man who delivered the car. He must take the bill or get condition card from the party who gives him the car. He cannot charge owners. Still this is owner's defect in one sense. When car is delivered the party who receives the car, if he makes repairs, must charge the man who delivers him the car, and not the owner, as I look at it.

Mr. Stuckie:—How would that apply where you could not get the material, say an eastern or southern car, and there is no material in the city with which to make repairs, how would you get around that?

Mr. Waughop:—Put on Master Car Builders' standard

A Member:—Under that head, if we deliver a car to a connecting line and there is a worn out brake shoe, we are not to charge the brake shoe to owners but to the fellow who delivered us the car. It does not seem hardly the thing; but that is the rule.

A Member:—I would like to know the limit of wear on a brake shoe before it is considered worn out.

Mr. Guthenberg:—I think there is a limit, Mr. Chairman, a limit of  $\frac{3}{4}$  inch.

Mr. Davies:—There is no limit to worn out brake shoes in the rules for '98.

#### Rule 3.

Mr. Davies:—There is a note under Section 43 which reads as follows: The word "coupler" in the above sections, numbers 35 to 43, inclusive, means the coupler body or knuckle. Consequently, if you break a knuckle and draft timbers this is a combination.

#### Rule 4, Section 5.

You will note in this section that wheels and axles are added, also repair card stubs in addition to the repair card.

#### Rule 4, Section 6.

The words "having either a pocket or spindle attachment" are added. This is to be understood that a pocket or spindle drawbar may be used in a car which is equipped with link-and-pin drawbar, if it is of sufficient strength and fitting properly.

Mr. Waughop:—I would like to state for the benefit of your members, that even if the car is so stenciled link-and-pin drawbar, yoke attachments, if it is offered in interchange with either stem or yoke, it must be accepted.

#### Rule 4, Section 7.

The words "measuring 32 $\frac{1}{2}$  inches" are added to this section.

#### Rule 4, Section 14.

In code of rules for 1897, is omitted entirely in new rules for 1898.

#### Rule 4, Section 14.

Note last two lines which have been added to this section, where it states, "that repair card stubs must state whether filled or solid journal bearings are applied or removed."

#### Rule 5, Section 1.

The following words are added to this section: "Except in case where owners are not responsible and the car bears no defect card covering the defects repaired."

#### Rule 5, Section 3A.

Is a new section entirely.

#### Rule 5, Section 4.

Note the words, "including their attachments, such as shoes, heads, jaws and hangers," are added. Your committee is of the opinion that the dead-lever guide was intended to be treated the same as the items above, and should have been included.

#### Rule 5, Section 6.

Note that the last four lines of this section are in addition to the sections of the 1897 rules.

#### Rule 5, Section 10.

In the schedule of prices, note that the freight car paint mixed, 5c. a pound is added. Under this section there is a note which reads as follows: Journal bearings having a lining  $\frac{1}{4}$  in. thick or thicker, shall be charged as filled journal bearings, and not as lined journal bearings. Also note in the third paragraph of this section the words "M. C. B. coupler and parts of the same" are added.

#### Rule 5, Section 11.

Note the new prices of M. C. B. couplers and parts of same.

#### Rule 5, Section 12.

Is changed to read as follows: "When M. C. B. coupler parts or metal brake beams are replaced, good second-hand material may be used, but they must be charged at 75 per cent of the prices when new. The credit for similar parts released from service in good condition must also be 75 per cent of the prices when new."

#### Rule 5, Section 17.

All the labor charges below the words "truck transom" are in addition to the rules for 1897. There is an addition to the note under this section as follows: The words locking pins, clevises, brake shoes and brake shoe keys being added; also the following note in addition: "Under this section, when it is necessary to apply an M. C. B. coupler on account of a broken or missing knuckle, the usual labor charge for replacing a coupler can be made. No additional labor to be charged for applying center pin or friction rollers, when center plate bolts or center plates are renewed on same end of car."

#### Rule 5, Section 18.

Has the following addition: "Pipe nipple or end of train pipe renewed, 5c."

#### Rule 5, Section 23.

Note change in price of trucks.

#### Rule 5, Section 23.

Note carefully the additions to this section.

Mr. Waughop:—I am pretty near the father of that rule. It means it is not necessary hereafter, after Sept. 1st, for any railroad company to card with a Master Car Builders' defect card any car owners defect to a switching rod. In lieu thereof it will be necessary for you to give them joint evidence. In case a Milwaukee car is delivered to any of your lines by the Belt railroad of Chicago, with a follower broken, if you please, all that will be necessary for your representative is to give to the representative of the Belt Line joint evidence that the defect existed, not an M. C. B. defect card. This will do away with rebuttal billing by delivering line, as the switching line can then charge owner of car by attaching the joint evidence. That was the object of the rule—to do away with the rebuttal billing.

#### Rule 6, Section 3.

Mr. Davies:—The word "operating" is added to this section.

This closed the report on the new rules.

#### The M. C. B. Coupler Again.

Mr. Waughop:—I asked a question awhile ago; I would like to get an answer. What will you do with an M. C. B. coupler equipped with a malleable iron knuckle if offered in interchange? Are you going to pass it, or are you going to stop it? That is of vital importance to us, as we have thousands of them. We want to know what we will have to contend with at this end of the C. & A. road.

Mr. Davies:—If I got a car with such a knuckle, providing I caught it, I would hold delivering line. If I didn't catch it, the only thing I could do would be to let it pass. There will be a lot of cars running around that nobody will catch.

Mr. Waughop:—I will tell you what we are going to do. We are going to pass it. If it is broken, or if it is necessary to replace it with a knuckle, we are going to repair it with either a wrought iron or semi-steel knuckle and charge it to the owner. As I said before, we haven't time to test each knuckle that passes us. We will not stop it because it is of malleable iron.

Pres. Hunt:—In this case, Mr. Waughop, the owner may say that he has not any of this kind of knuckle, and the delivering company ought to be responsible.

Mr. Waughop:—In this case the owner cannot say any such a thing. There are only three couplers in the country that have put in these knuckles. I will not name them. One has made upward of 200,000 of these knuckles. There are a limited number of another make, and a limited number of a third one. They don't amount to anything. The people who have adopted that knuckle—and they are people right here in Chicago, and you cannot ignore their judgment—think, I presume, that this knuckle is all right. I don't. They have it within their province; but it is not within the province of any receiving line to question their judgment as to what they shall put in their cars. If they see fit to put on a malleable knuckle on their car and it breaks, the receiving line does not have to put on a malleable iron knuckle, but can put on wrought iron or steel and charge them for that knuckle. I cannot see anything for us to do but to pass the car. Now, if you people are going to stop that car, of course we will have to retaliate. I don't want to. Of course it would only make a lot of trouble for anybody's cars that have them on; it would be a detriment to interchange here and a detriment at our place, and I will say frankly until I get further orders, we will pass them.

Pres. Hunt:—How would it do if that rule read "M. C. B. couplers not equipped with steel or wrought iron knuckles on couplers where such knuckles are standard?" That would allow malleable iron coupler to go where it belonged.

Mr. Waughop:—I made a recommendation to the Master Car Builders, personally, that that rule be changed to read, "Master Car Builders' couplers equipped with malleable iron or steel, if replacement is with wrought iron, malleable iron or steel may be used." That would cover the point; but they did not see fit to let it go in that way.

Pres. Hunt:—Of course, according to the rule, the road would be justified in holding delivering company, and unless he got their construction he would likely do it.

Mr. Waughop:—Is your Master Car Builder going to

instruct you to stop and test every knuckle that may come to you from a delivering line?

Pres. Hunt:—No; I presume not.

Mr. Waughop:—How do you expect your inspector to tell if you only give him a limited time to inspect it?

Pres. Hunt:—Pretty difficult thing.

Mr. Waughop:—Are you going to pass the car? There will be no trouble at our end.

Secy. Sharp:—In behalf of the interchange at Chicago, I do not believe there will be any cars stopped on account of not being equipped with a steel knuckle. If you will read the proceedings of the M. C. B. convention you will see the point they got at in leaving that rule in there. Mr. Mitchell, who is superintendent of motive power of the road I am connected with, is responsible for having that rule left as it was last year, and it was discussed there in the convention very thoroughly. The point was to bar out east iron or other inferior knuckles. Now any car man knows that a cast iron knuckle is not what we want in service, and it was generally conceded on the part of those in attendance at the M. C. B. convention that the inspectors generally would not be able to tell the difference—whether it was a steel or semi-steel knuckle, and they did not contemplate any difficulty along that line. It was just simply a dose of preventative.

Mr. Waughop:—I would like to say for the benefit of the gentleman that the car inspectors generally are not expected to know what the discussions were. They don't know. The rule, as it reads, of course, prohibits the receiving of the car with anything but those two kinds of knuckles in. That is one of the rules we won't live up to. We might as well say so. We can't live up to it, and unless we get positive orders to live up to that rule strictly as it reads, we will do at St. Louis just as I said—we will pass the cars.

Secy. Sharp:—I would like to answer that last remark. I have taken pains to see that a copy of the verbatim report of the convention is in the hands of all car inspectors at the present time, and those technical points are the points we are going to call their attention to.

Mr. Waughop:—I want to tell you you are the only man of good sense I have met this year. I think it is a pretty good thing for all car foremen to put in the hands of inspectors the proceedings of that meeting.

Mr. Canfield:—I think Mr. Waughop is not well acquainted with Chicago practice. That has been the practice on the Rock Island for years.

This closed the discussion.

#### Closing Business.

The following invitation was read:

Joint Car Inspection Association of St. Louis and East St. Louis.  
St. Louis, July 28, 1898.

Car Foremen's Association:

On the 16th day of September, 1898, a meeting of Joint Car Inspectors from different parts of the United States will be held at St. Louis Union Station, room No. 212, at 9 a. m., for the purpose of going over the new M. C. B. rules, which will be in effect on and after Sept. 1, 1898, and endeavor to come to a uniform interpretation of the interchange part of them, and also to consider any other questions that may come up; and we extend to your association an invitation to attend, individually or collectively. Chas. Waughop, E. Swineford, Sec'y. Chief Joint Inspector.

Pres. Hunt: On behalf of the members of the Car Foremen's Association, I thank Mr. Waughop for the invitation to attend the meeting at St. Louis Sept. 16, and hope that those members who can will be there. Also we thank him for his attendance here this evening and beg to say that we have been greatly benefited by the remarks he has made on the subjects of the M. C. B. coupler and the new rules of interchange.

The meeting then adjourned.

The next regular meeting of the association will be held in the Great Northern Hotel, Chicago, on the second Thursday—the 5th—of September.

There will be a further discussion on the new rules of interchange: Mr. S. J. Kidder, of the Westinghouse Air Brake Company, will give a talk on air brake practice; and there will also be presented a number of disputes as to interpretation of the rules in interchange work, covering actual cases of disagreement, and these will be discussed by the members.

#### COMMENT BY CAR FOREMEN.

[The notes in this column are contributed by members of the Car Foremen's Association of Chicago; the RAILWAY MASTER MECHANIC assumes no responsibility for the expression of views therein contained.]

From the Publication Committee.

We shall be glad to have communications for this column from car men on subjects of interest to members of the craft.

There is no doubt but that we have men in the car departments of lines in the West, who are capable of writing interesting articles and there is no reason why the Railway Master Mechanic should

not come to the front as a representative car man's paper.

Let us hear from you.

T. R. MORRIS, CHAIRMAN PUBLICATION COMMITTEE.

#### "Comby from Sliding."

Was it the intention of the Master Car Builders, when framing Sec. 2, of Rule 3, of the 1898 code, to consider "comby from sliding" spots as coming under the head of "shelled out?" And why was the description of a shelled out wheel omitted from the 1898 code? There is already considerable difference of opinion in regard to this, and there is no doubt of its coming to the front as a question that will cause controversy. According to the opinion of one of our most prominent wheel makers, and a most reasonable one it is, a shelled out spot in a wheel is a defect caused by improper pouring of the metal when being cast, or by some foreign substance in the metal. A "comby from sliding" spot carries with it the full explanation, and decides the responsibility, as the owner of a car is liable only for those wheels flattened on his own road, if they exceed the limit. As one of the members of the Car Foremen's Association said, "It would be wrong to charge an owner for a comby wheel that has been slid by some other road and not removed, but allowed to run until it got comby."

#### Missing End Gates.

There seems to be quite a number among those connected with the various car departments of railway lines at Chicago, who think that Case No. 513, recently decided by the Arbitration Committee, making owners responsible for missing end gates, is quite a hardship on said owners. A car foreman here was recently heard to say, "I certainly think this decision a wrong one. Section 40, of Rule 3, of the 1896 code, refers to 'locks, grain doors and all inside or concealed parts of cars missing or damaged under fair usage,' and this is used by the committee as a basis for the decision. It seems to me rather a stretch of the imagination to include end gates with locks, grain doors and inside or concealed parts of a car. To say that 95 per cent of all end gates are securely fastened to the car is a fair estimate, and the proportion of these that are lost in fair usage is very small indeed. Almost invariably it is the shipper or the consignee of freight who is responsible for the detaching of the end gate from its fastenings, and this is done to facilitate loading and unloading. Bolts are taken out, rods loosened, the gate pried out of position and thrown on the ground and anathemized for the trouble it has caused, and the car soon after appears on the repair track of the line that happens to have it at the time, a new gate is built and charged to owners. If this is fair usage, save us from what would be called 'unfair.' It is more like wanton destruction. There is no inducement for a railway company to protect the property of another company if they are backed up by such decisions."

#### Is the M. C. B. Coupler a Failure?

In his remarks on the M. C. B. coupler, at the meeting of the Car Foremen's Association, Mr. Waughop, of St. Louis, said: "The M. C. B. coupler is a failure." While this may appear rather a strong statement, still there are conditions which, if properly considered, make one hesitate to pronounce it heresy altogether. Is the construction of this coupler such that we can truthfully say we

think it is, better than any other, able to withstand the shocks that, as a natural thing, it is supposed to endure? Certainly the knuckle is, by the legally defined contour lines, confined to limits which experience has shown us does not leave it sufficiently strong to stand up under the shock of two heavily loaded cars coming together at a speed of from two to six miles per hour. As Mr. Waughop says, we are allowed to strengthen the body of the coupler to almost any extent, but the weak point, the part that breaks, we are forced to leave severely alone. Another thing that is commencing to make itself felt on cars equipped with M. C. B. couplers, is the indirect draft that is the necessary consequence of the peculiar construction of the same. It causes defects that did not exist on cars which had the old style link and pin bars, and aggravates some of those that did. It is a subject that offers opportunities for a great deal of discussion, which might result in much good to railway companies who now use so many of these necessary articles.

#### Communications

##### The Work of the Association.

To the Editor: I attended the August meeting of the Car Foremen's Association, and was much interested in the discussion of the new rules of interchange.

A majority of the members seemed to have had no previous knowledge of them, and this had the effect of restricting the discussion to an appreciable extent. The committee that was to have reported on the new code did not do justice to the subject, as it was supposed they would have come forward with a more complete explanation of new ground covered and recommendations for future guidance.

Section 20, of Rule 3, was the subject of quite a controversy. The making of a delivering line responsible for worn out parts of a brake entails much more work on the part of the inspector, as Mr. Sharp truthfully stated, and this is something that it has been the object of the rules to avoid. Mr. Waughop's explanation that the responsibility is placed on delivering line as a "penalty" is hardly consistent. The punishment is so much greater than the crime, and imposes in so many cases a hardship on the delivering company, that I think it is one of the rules that would be "more honored in the breach than in the observance."

Judging by what I heard at this meeting, I should say that the association is filling a long felt want, and it certainly should have the support of all car men.

M.

##### Loose Rivets.

To the Editor: The matter of loose rivets in steel trucks is one that is now attracting considerable attention among car men. Is there any way to prevent rivets getting loose in this manner, and what is the limit of safety?

X. Y.

##### Hollow Wheel Treads.

To the Editor: Two prominent western lines recently had a controversy as to the limit of wear on a wheel in reference to the defect known as "tread worn hollow." In view of the fact that the M. C. B. rules do not state definitely the maximum wear, it would be interesting to know what rule practical men follow who remove

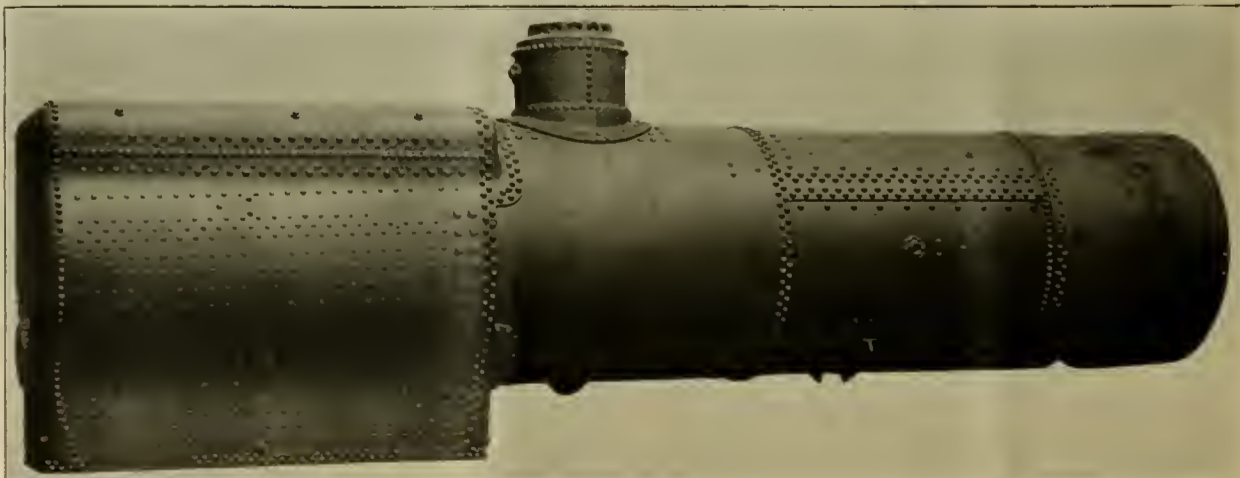

BOILER FOR CONSOLIDATED LOCOMOTIVE—B. & M. R. R.

wheels for this defect. Would it not be advisable to have a gage to show the limit of wear? T.

**Worn Out Parts.**

To the Editor: As it is now almost September the first, after which we will be working under the new rules of interchange, it is quite natural that we would be considering those parts which would appear to be most difficult. I would therefore call your attention to "Rule 3, Section 20." What are we to understand by the words "or

Piston heads.....Cast steel, Dunbar packing  
 Piston rods.....Steel, 4 in. diameter  
 Boiler jacket.....cold rolled pickled steel, painted  
 Type of boiler.....Belpaire  
 Diameter of boiler at smallest ring.....74 in.  
 Crown sheet, supported by stay bolts...1½ in diam.  
 Stay bolts, 1 in. dia., spaced 4 in. from center to center  
 Number of tubes.....292  
 Diameter of tubes.....2¼ in.  
 Length of tubes over tube sheets.....14 ft. 6½ in.  
 Length of firebox, inside.....114 in.  
 Width of firebox, inside.....40 in.

Not only has this been demonstrated by the derailing of tenders where this rigid connection has been made, but it can be easily demonstrated by diagraming a four-wheel baggage or express car, built without platforms, and a six-wheel car with such platform. The centers of the couplers will be several inches out of line with each other, and it has been demonstrated that in order to force them into line a transverse pressure of upwards of 50,000 lbs. has to be exerted. While these are exceptional cases, the same holds good in degree throughout our whole equipment, and taken in connection with the "demnition grind," both



CONSOLIDATED LOCOMOTIVE--B. & M. R. RAILRAD IN NEBRASKA.

worn out parts?" Would this not cover worn out brake shoes? It is not the opinion of the writer that it was the intention of the Master Car Builders to make a rule compelling the delivering line at an interchange point to issue a defect card for worn out brake shoes. Does this not conflict with the preface? S.

**CONSOLIDATED LOCOMOTIVE--B. & M. R. RY. IN NEBRASKA.**

The Burlington & Missouri River Railroad in Nebraska is receiving the lot of four consolidation engines ordered some time ago from the Pittsburg Locomotive Works. The accompanying reproductions of photographs show one of these engines and also its boiler.

These engines are to run on the Deadwood line of the B. & M. in Nebraska. That they are a fine appearing engine can be seen by reference to the engravings. A noticeable feature of these engines is that the driving wheel tires are all flanged. This departure from regular practice will be observed with interest, as it is more or less an experiment, especially when the track the engines are to run over is considered. There are a large number of 3 per cent grades and 16 degree curves on this line.

To partially overcome the crowding of the rail the forward and rear driving wheel flanges are turned down 1-16 below M. C. B. standard, making the flange 1 3-16 thick instead of 1 1-4. The second and third drivers have flanges of standard dimensions. All drivers are set ¼ closer together than regular practice, making the distance between backs of tires 4 ft. 5¼ in. instead of 4 ft. 5¾ in.

It is expected that these engines will haul a 15 car loaded train up a grade that has hitherto been covered by consolidation engines that have only 10 cars.

Appended are the general dimensions of this locomotive.

**GENERAL DIMENSIONS.**

Fuel.....Bituminous coal  
 Gauge of track.....4 ft. 8½ in.  
 Total weight of engine in working order...160,000 lbs.  
 Total weight of engine on driving wheels...166,000 lbs.  
 Total weight of engine empty.....162,000 lbs.  
 Weight of tender with fuel and water...98,600 lbs.  
 Driving wheel base of engine.....15 ft.  
 Total wheel base of engine.....23 ft. 6 in.  
 Total wheel base of engine and tender...53 ft. 2 in.  
 Height from rail to top of stack.....15 ft.  
 Height from rail to top of boiler.....8 ft. 9¾ in.  
 Cylinders, diameter and stroke.....22x28 in.  
 Slide valves.....Richardson Balance

Brick arch.....Supported on studs  
 Working pressure.....180 lbs.  
 Kind of grates, R. R. Co.'s standard.....Cast Iron  
 Grate area.....32.67 sq. ft.  
 Heating surface in tubes.....2,486.4 sq. ft.  
 Heating surface in firebox.....188.6 sq. ft.  
 Total heating surface.....2675 sq. ft.  
 Diameter of driving wheels outside of tires...52 in.  
 Diameter and length of journals.....9x10 in.  
 Diameter of truck wheels.....30 in.  
 Diameter and length of journals.....5½x9 in.  
 Type of brakes.....Westinghouse American  
 Type of tank.....Hopper, R. R. Co.'s Standard  
 Water capacity of tank.....5,000 U. S. Gallons  
 Fuel capacity of tank.....10 tons

**THE M. C. B. COUPLER CRITICISED.**

At a recent meeting of the Central Association of Railroad Officers, Mr. Pulaski Leeds, superintendent of machinery of the Louisville & Nashville, presented a paper in the course of which he rather savagely criticised the M. C. B. coupler. To the queries with which he heads his paper: "Does the present style of vertical plane coupler meet all requirements," and "Has it come to stay," Mr. Leeds gives an emphatic negative to the first and an equally emphatic affirmative to the last. Then he asks "What are you going to do about it?" The substance of his paper is as follows:

It seems to me scarcely credible (or creditable) that the adoption of this device should have resulted from a careful investigation and consideration of the conditions and requirements of service: first, that the concussion should be evenly and squarely met on a central line; second, that the pulling strain should be on a central line to avoid all tendency to crowd the flanges against the rail; third, that the connection should be so flexible that there should be no unnecessary friction at any time, or difficulty in coupling on any practicable curve; fourth, that the device should be capable of having its strength increased to meet future requirements of heavier motive power; fifth, that it should be always operative; sixth, that there should be as great a uniformity as there was in the link and pin.

In my opinion the present style of vertical-plane coupler contains none of these essentials. When cars are thrown together the greater part of the blows are received at the point of greatest adverse leverage, far outside of the center line of column. In pulling, the line of strain is considerably out of center. The connection is not as flexible as it should be, as for obvious reasons the bar must not have any great amount of lateral movement; hence, where there is an appreciable difference in the overhang of two cars, as in the case of a car with a six-wheeled truck coupled to one with a four-wheel, there is a great leverage tending to crowd the car with the shorter overhang off the track.

vertical and horizontal, caused by the motion of the cars and a rigid side bearing, as against the pivoted action of the link and pin, not only causes our trams to pull harder, but is destructive to both equipment and track.

This device was adopted when the car equipment and motive power were a great deal lighter than now, and the lines that were adopted were those that had been produced to meet the requirements of that time and in competition commercially with the link and pin, and as those lines were such as precluded the possibility of increasing the proportions, the only increase in strength lies entirely in the quality of the material used, and the temptation to consider first cost is so strong as to, in a great measure, defeat this measure; in fact, this point of first cost is so strong that there are couplers in which the weight has been reduced from the original construction, enabling the manufacturer to reduce the price per car while getting practically the same price per pound.

As to the unlocking devices being at all times operative, it can be safely said that any coupler which can be fairly criticised upon fixed mechanical principles as likely to give trouble at a given point will, after a certain amount of strain and wear in service, surely prove troublesome at the point thus criticised. This criticism can fairly be made upon mostly all couplers in service today; thus any coupler of a design likely to break or get out of order readily, to couple with great difficulty under some of the ordinary conditions of service, to come uncoupled, not to uncouple when required, is faulty, and such defects are more likely to develop when all cars are equipped with the M. C. B. couplers.

While it is incumbent upon us to so construct our draft rigging as to render the danger of bars pulling out as small as possible, still it is a fact that they do so, and also that bars break, in which case we lose the old safeguard of the link and pin holding the head or bar up until the train is stopped; hence there has been an element of great danger introduced, and which no effective device, so far as I know, has been provided to meet

But allowing that there are some who agree with me, please answer the query, "What are we going to do about it?" The great number already applied, and the fact that within a short period all cars must couple automatically by impact, make it the standard of the country; and further, the fact that all couplers of the future must couple with this type prevents not only the introduction of any other type, but any improvements in this type as to the essential of strength. As I have heretofore remarked, these outlines were designed to meet the requirements of a service when the heaviest examples of motive power were such as are now being retired from service as being too light for economical operation; and while the ultimate tensile strength of the bar may still meet the requirements of the increased motive power, still the most destructive agency has been increased in the same proportion, i. e., the blows received in yards from moving cars of from 90,000 lbs. gross weight, as

against those of about 50,000, the velocity being a variable and unknown quantity, but probably not decreased. Yet with all its faults we have it still, and with the immense sums expended upon it we are likely to have it for many years to come; therefore the only thing we can do is to try and make it the most effective, serviceable, economical and least dangerous possible.

**A NOVELTY IN BUFFET CARS.—C. G. W. RY.**

The Chicago Great Western Railway recently placed in service on its Chicago-St. Paul-Minneapolis passenger run two new trains that are remarkably fine in all details. The leading feature of these trains, however, is to be found in the buffet cars, which in their design are not only decidedly novel, but decidedly pleasing.

These cars, of which we give plan and interior views, are entirely original in interior design and arrangement, looking more like a room, or a saloon on board an ocean-liner, than part of a railroad train. This effect is accomplished by abandoning entirely the almost invariable arrangement of such cars and omitting the ever-present sleeping car section. The two ends of the room are alike, both having a big corner seat, over one end of which is a leaded-glass window similar to those in the center of the car between the cabinets. By means of these leaded-glass windows the monotony of the usual long row of windows of the same size is avoided, there being on each side two groups of three windows each, besides the leaded-glass windows and one larger window at each end. In the center of the room is a table on which is a standing-lamp and there are also small tables at each end so that it is possible for a number of men to talk together in groups almost anywhere, which cannot be done in the usual bowling-alley car; and there are many places upon which to put bottles and other things.

The design of the roof which is very original helps very much to give the car the air of a room. There is no cove under the deck, the latter coming out straight from a wall which is treated in an entirely uncarlike manner without pilasters. Above this is a complete dome springing from the ends of the room as well as from the sides, and without lunettes for the deck sash, the latter being covered by brass grilles, leaving the line of the dome unbroken. Besides the lamps in the center of the ceiling, there are four lamps in small domes, one in each corner of the car, so that the lighting is extremely effective.

The car is finished in Padouk, treated rather in Empire style, using a good deal of brass and abandoning entirely every tradition of interior car design. The chairs are upholstered in light-green leather.

The forward end of the car is, as shown by our plan view, not used as a baggage compartment, as is usually the case, but is fitted up with seats as an ordinary coach. Intervening between this portion of the car and the buffet

is a comfortable conductor's room. This car was designed by Architect Stem, of St. Paul, and Mr. Tracy Lyon, master mechanic of the Chi-

fastenings for locomotive cylinders. This report we gave in abstract in the Railway Master Mechanic for August, 1898. A supplementary report was present-

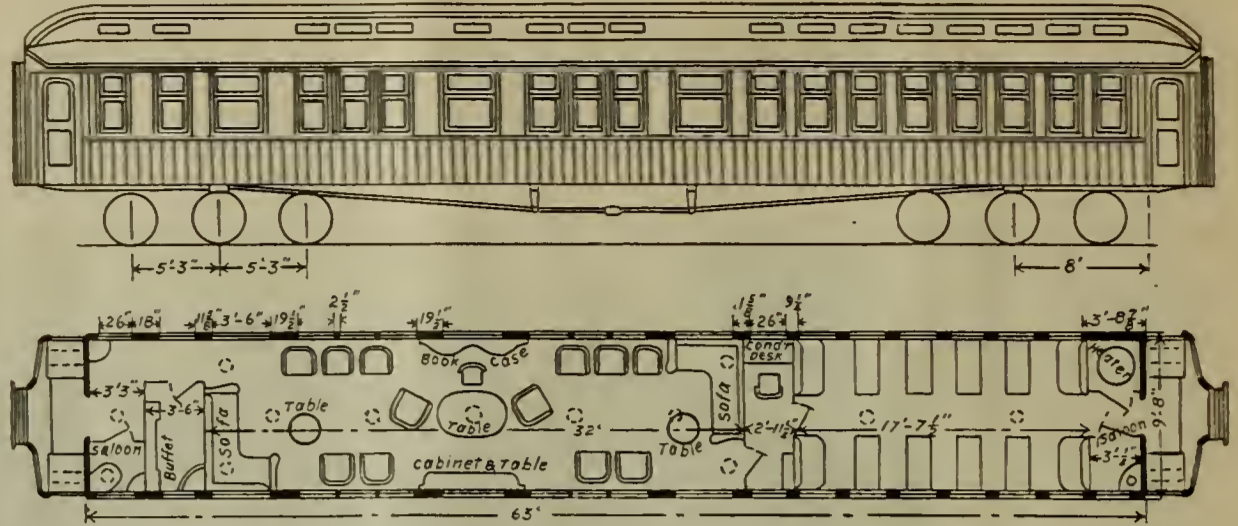

BUFFET CAR—CHICAGO GREAT WESTERN RY.

ago Great Western, and was built at the Pullman works.

**LOCOMOTIVE CYLINDER FASTENINGS.**

At the Master Mechanics' Convention at Saratoga there was presented a committee report on best

ed by Mr. J. E. Sague, chairman of the committee, and the substance of this report we now give. This supplementary report came about in this way: It had been impossible to arrange for a meeting of the full committee, and the members, therefore, were unable to discuss the subject thoroughly enough to agree fully upon all details. Owing to business engagements, the chairman of the committee was unable to assist in the final preparation of the report, and the work was therefore kindly assumed by Mr. Sanderson, although the time left at his disposal was very limited. Mr. Sague's supplemental report was submitted as an additional submission, and to cover some of the items of information which came to hand after the main report was completed; and was not intended as a criticism of the report by Messrs. Sanderson and Chapman in any detail. Mr. Sague's report was substantially as follows:

The strains on cylinder fastenings, as well as upon other parts of locomotives, have been much increased within the last few years by the notable rise in boiler pressures, which has resulted in a more marked increase in locomotive power than is indicated by comparison of cylinder sizes only. Thus many recent designs of locomotives have 20x26 cylinders with 200 lbs. boiler pressure, or the equivalent of a 23x26 cylinder with 150 lbs. of steam. Modern systems of tonnage rating have also added to strains imposed upon locomotives, making it certain that they will exert their full power more constantly than ever before.

A decided limit, however, is imposed upon the weight of material to be used in cylinders and frames by the demand for high boiler power, and it is very common for builders to have specifications submitted to them calling for greater boiler capacity than can be obtained within the permitted limits of weight, after all possible has been done to lighten other parts. It will be admitted that in order to obtain the best road locomotives, either passenger or freight, the boiler must be made as large as possible, and with this in view the weight of all other parts must be kept as low as design will permit, assuming reasonably good handling and attention to running repairs, and this condition should be kept carefully in mind in considering the design of cylinders, frames and cylinder fastenings.

The principal strain to which cylinder fastenings are subjected are thoroughly discussed in the committee's report. The effects of these strains on cylinder fastenings, however, are believed to be greatly modified by the use or absence of a foot plate. A foot plate well bolted and keyed holds the frames rigidly in line with each other lengthwise and thus reduces greatly the racking strains upon the cylinders due to the action of the steam. Consolidation and other types of locomotives which have no foot plate, therefore, require exceptional strength in the cylinder fastenings, unless the equivalent of a foot plate is provided. This point is illustrated in an abstract of a letter from Mr. Harvey Middleton, general superintendent of motive power of the B. & O. R. R., referring to locomotives not provided with foot plates. "To prevent breakage of cylinders and frames we further strengthen these engines by using a cast iron plate ahead of the cylinders, performing the same office in keeping the frames square and preventing racking of the cylinders as the foot plate in the American type of locomotive. We are using this cast iron deck plate on all of our locomotives which have not the foot plate at the rear of the fire box. It fills the space between the front cylinder and back of bumper. This plate space is 2 feet, 7½ inches long. In addition, a cast iron frame tie two feet long is used to further assist



BUFFET CAR—CHICAGO GREAT WESTERN RY.

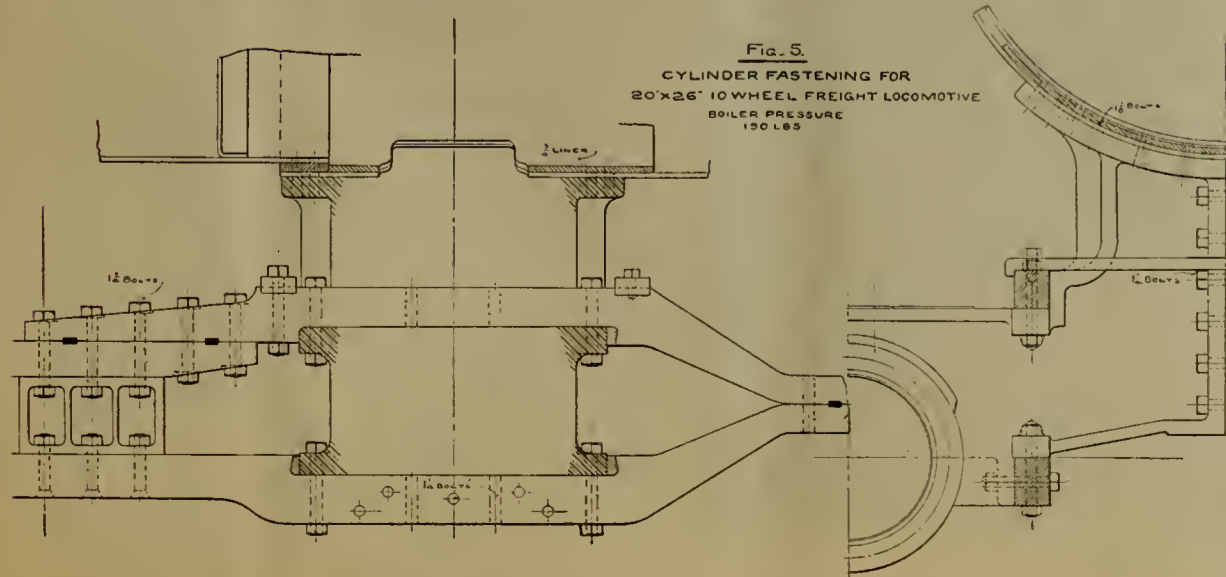
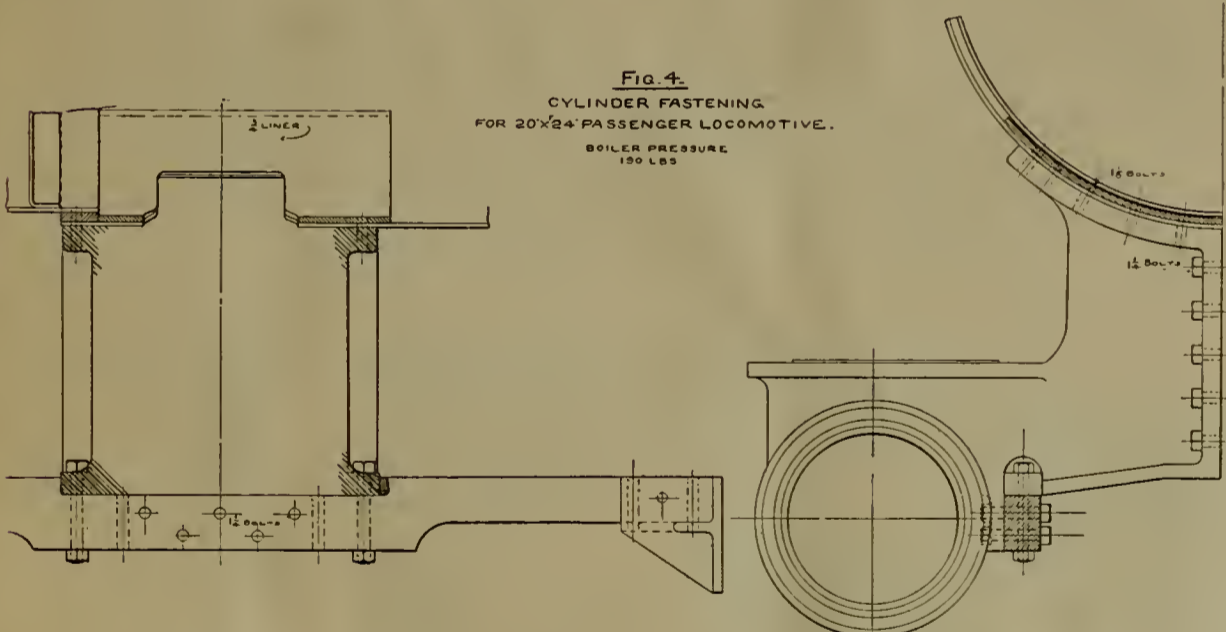
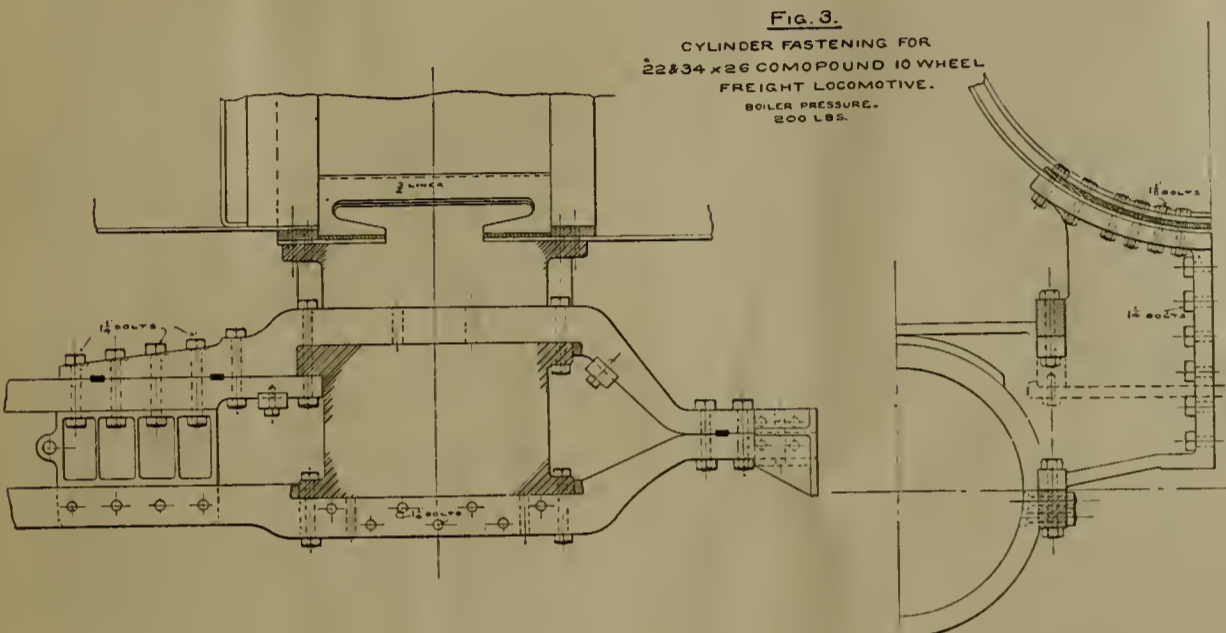
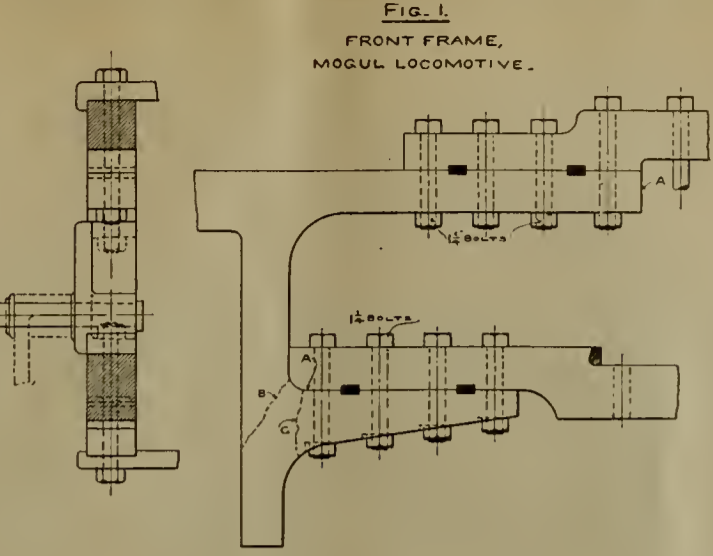
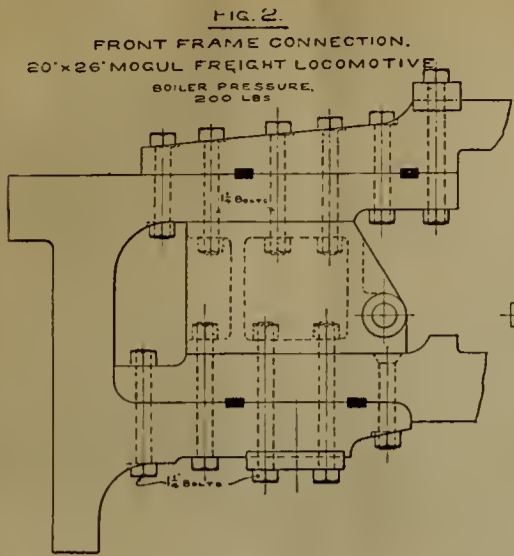

in holding the frame square." Upon this point Mr. Vauclain, of the Baldwin Locomotive Works, writes: "I am inclined to think that on extra large engines the cast iron deck plate in front of the cylinders is a good thing in the absence of a foot plate, but better still, add the foot plate to be done with it."

In recommending designs of cylinder fastenings distinction should be made between passenger and freight locomotives, even where the cylinder power is the same. Passenger locomotives exert their full tractive power only at starting and the cylinder fastenings are not exposed to as severe continuous strains as those of freight engines. Passenger locomotives, as a rule, also receive better care. Large boiler power is of such supreme importance in passenger locomotives that the weight of all other parts must be reduced as much as possible. These considerations, it is believed, justify the use of lighter cylinder fastenings than would be a good practice for freight. This is especially true for eight-wheel passenger locomotives whose truck and driving wheel weights are apt to be close to the track limit.

Referring to the connection of cylinders to boiler, the replies to the committee's circular indicate but little trouble with this fastening. Several recommend double bolting either front or back or on the side flanges. The largest bolts shown on any design submitted are 1 1/4 in. and a great majority of satisfactory fastenings for heavy locomotives are made with 1 1/2 in. bolts spaced about five inches from center to center. Double bolting front and back or on the sides are extensively used on heavy locomotives and in a few cases cylinders are double bolted all around. Double bolting front and back has the advantage of lengthening the cylinder fit on the smoke arch and enables the maximum number of bolts to be placed through the smoke box rings, but for equal weight of metal in the flanges the double side bolting enables more bolts to be used. The Erie railroad reports that it has not been necessary on their locomotives to double bolt any part of the cylinder saddle to the smoke box. Saddles should be carefully fitted to the smoke boxes and there should be a good bearing around each bolt so that the full shearing strength may be secured. All bolts in cylinder fastenings should, where possible, be tapered to secure good fits. Smoke box holes should be drilled in place in either the saddle or sheet and the reaming should be preferably done by power, thus making it easy to get good work.

Regarding the connection of cylinders to frames and the design of the frames at the cylinders, practice varies greatly and it is difficult to lay down any rules which will be of general value; especially is this true regarding the choice between single and double bar front frames. Double front frames certainly give a more secure cylinder fastenings than can be obtained with single rail frames. They make an especially good design for consolidation, mogul and other locomotives in which the drivers are close to the cylinders, and are being widely adopted for heavy ten and twelve wheel locomotives. Considering the strength of the frames only, the design of double front frames involves the use of more weight for equal strength than with single, and this is an important reason for the continued use of single front frames on so many recent eight wheel passenger locomotives. For this type of locomotive the great length of single front rail permits some flexibility and there is less liability of the strains being concentrated at breaking point than if the rails were short. With the single front rail bolted on a line with the centers of the cylinders the strains due to the steam pressure are taken directly. With double front frames these strains are exerted mostly upon the bottom rail, as this rail is necessarily much nearer to the center of the cylinder than the upper one. The bottom rail, therefore, requires nearly as much section as if a single rail only were used. The breakages of upper rails, however, show that important strains are transmitted through them, and these are probably quite complex. Very great strains are brought on the upper rail by the expansion of the boiler, especially when the expansion pads are binding. Any yielding or springing of the bottom rail will also throw disproportionate strains on the upper one. The experience of members indicates that to avoid trouble with double front rails it is necessary to design them so as to be as free from bending strains as possible and to connect them so that they will resist the strains almost as if made of one piece; otherwise the rails may yield and break in sections. This can perhaps be illustrated by reference to drawing No. 1 which shows the design of front frames reported by one of the members as used on mogul freight locomotives in heavy service. Careful inspection of these front frames showed them to be working slightly at points marked "A." This in some cases has caused breakages at "B" or "C." The indications point to bending strains localized where the working and breakage are noticed and it is also believed that this working was largely caused by the sticking of the expansion pads on the sides and back of fire box. To resist these strains more successfully filling blocks similar to that shown on drawing No. 2 are put in and are found to meet the difficulties successfully. The C. B. & Q. railroad reports similar difficulties with mogul frames and in this case the trouble is overcome by

making the lower rail heavier and in one piece with the main frame. For ten and twelve wheel locomotives which involve greater length between the forward pedestal and the cylinders, the filling pieces are thought to be even more necessary than in mogul and consolidation locomotives, and it is believed that double front frames not provided with such bracing will give more trouble than single bar frames. Mr. Middleton of the B. & O. advises single front frames on eight wheel locomotives and on ten wheelers having a considerable distance between the front pedestal and the cylinders. Mr. Vauclain writes: "We recommend single front rails for frames on engines having a four wheel truck ahead, and double frames for two wheel trucks. In any case where the single front frame is radically out of line with the draw head, double frames should be used." Other correspondents generally recommend double front frames—the Erie for all classes of engines, and the C. B. & Q. on all engines having over 18x24 cylinders.

The writer believes that the following is good practice: Double rail front frames should be used on all consolidation and mogul locomotives and on heavy ten and twelve wheel freight locomotives, especially where built for mountain service. Single front frames should be used on eight wheel passenger locomotives, as they have been found amply strong for this class of engine with good design and maintenance, and because the use of double frames would necessitate increased driver and truck weights for a given boiler capacity. The same applies to fast passenger ten wheelers where great boiler power is desired and where close limits of weight are to be conformed to. For large ten wheel passenger locomotives to be used on mountain work or in exceptionally severe service, the better cylinder fastening obtained by the double front frame makes its use advisable. Filling blocks should be used for double rail frames as before indicated and the splices between the front and main frames should, as far as possible, be designed to avoid bending strains.

To prevent cylinder saddles breaking due to the expansion of boiler, some members recommend outside vertical ribs, as indicated on figure 5. These, with the lower cross ribs shown and with the bolts through the outside lugs which the ribs form at the frame connections, are believed to make a very secure job.

Regarding the advisability of using cross ties front and back of the cylinders assist in tying the frames to the cylinder saddles, there has been a strong expression of opinion from members in favor of using one or the other of these devices. For double front rails, cross ties lipped over the top rail and shrunk on front and back of the cylinders assist in tying the frames to the cylinders and also greatly help the connections between the cylinder saddles. The action of the steam in the cylinders tends to spring the frames otherwise and separate the cylinders where bolted together, thus practically bringing a cross-bending strain upon the saddles; and the cross ties are very effective in resisting these strains. Cast iron, although very strong in compression is deficient in tensile and transverse strength, and it is, therefore, believed that wrought iron or cross ties serve a better purpose in reinforcing the cylinder saddles than would be obtained by increasing the saddle length, and with much less increase of weight. Where cross ties are used suitable flanges, of course, should be provided on the cylinders to resist the pull of the cross ties. Inside lips on the cross ties are unnecessary and if well fitted prevent the cross ties being shrunk on after the frames are bolted in place. The advantage of cross ties is shown from the fact that they are used successfully to hold cylinder saddles after cracking and therefore cannot fail to assist in preventing cracking. Long transverse bolts through the cylinder saddles serve the same purpose in holding the saddle together as cross ties, and have been found very useful on many roads, but they are not thought to be as effective as cross ties, as they do not assist in holding the frames to cylinders and cannot be spaced as advantageously to resist bending strains in the saddles. They are useful, however, for cylinders having single front frame connections. Where used, they should be placed as low down in the saddle and as near the back and front as possible.

Regarding the connections between cylinder saddles but little trouble is reported, and a single row of 1 1/4 bolts spaced about 4 1/2 centers through the back and front vertical flanges of saddles are believed to be sufficient, together with center plate fastenings, if the frames are suitably braced longitudinally with a foot plate or the equivalent. Bottom flanges, keys between the saddles or special reinforcement of the joint between the saddles seem unnecessary, especially when the cross ties or transverse bolts are used as before referred to. The designs shown in figures 2 to 5 are believed to illustrate good practice for cylinder fastenings on the class of engines named. All of the designs have been applied to locomotives in very heavy service during the past two years and no reports of failures have been received.

Plants for Treating Railroad Ties.

Wood-preserving plants for treating railroad ties are now in operation at several points on the Santa

Fe system. One at Somerville, Texas, has six cylinders and those at Las Vegas, N. M.; Belmont, Ariz.; and Laramie, Wy., have two cylinders each. The capacity of each cylinder is about 1,000 ties per day of 24 hours. All these plants were built or designed by Rowe & Rowe, 226 LaSalle street, Chicago.

THE HARRISON DUST GUARD.

The Harrison dust guard, which has been attracting considerable attention of late, is shown in full detail in our engraving, which is reproduced from a blue print of the working drawing prepared for this device on the Lake Shore & Michigan Southern Ry. The cut thus shows the size and kind used on that road for a 4 1/4 x 8 in. journal.

The principle and construction of this guard are fully revealed by the engraving. It is made of sycamore wood and is lined with heavy belting leather. The two parts are held together by the brass springs shown, and the whole is topped with a pine wedge. The guard keeps closed around the journal under all circumstances, and takes up automatically any wear that may develop, the latter being however slight because of the peculiar adaptability of the leather ring to its work. The springs are fully protected by the wedge cap which is driven into the top of the oil box. This cap serves the important purpose of closing effectively one of the worst points of ingress of dust and sand to the bearings. This point in a journal box has been neglected for years, while every effort has been made to close the front of the box; but it is of late beginning to be realized that the back end must be better cared for.

A perfected dust guard of this nature effects economy by reducing friction, which means a saving in power; by reducing the delays to trains caused by hot journals; by keeping the sand away from waste, which mats it up and causes it to fall away from the journal; by keeping the oil in the box, thus saving oil; and by saving in brass wear—this latter an exceedingly important feature. This guard is claimed to have shown as high in one instance as 50 per cent saving in brass on a mileage of 8540 miles.

Mr. Frank B. Harrison, president and general manager of the Harrison Dust Guard Co., and the

inventor of this guard, spent ten years in actual railway work, a part of the time as brakeman. In toiling up and down long trains with a dope can, fighting hot boxes, he observed that a board with a hole in it was the primitive device used to keep oil in and dirt out of journal boxes, and that after running a short time it did neither, for the oil ran out on the wheels as fast as put in and the packing quickly became matted with sand. He accordingly worked at the design for a guard which he is now presenting.

This guard, under tests of over 50,000 miles, has not developed perceptible wear and has maintained its efficiency as a dust excluder and oil retainer. It has been in practical use now for over three years. It is now in service on the Lake Shore & Michigan Southern, Seaboard Air Line, Southern, Wheeling & Lake Erie, Jacksonville, Tampa & Key West, Florida Central & Peninsular, Toledo, St. Louis & Kansas City and 40 other lines. The office of the Harrison Dust Guard Co. is at 900 Summit street, Toledo, O.

WEIGHTS OF M. C. B. CAR COUPLERS.

Secretary Cloud, of the Master Car Builders' Association, issues the following list of weights of couplers and parts of same, having compiled it in accordance with recommendation of the Committee on Prices in M. C. B. Rules as approved by the association in convention at Saratoga, June, 1898: American Coupler:—American Coupler Co., 1413 Fisher Building, Chicago, Ill.

Bar, 160 lbs.; lock, complete, 9 lbs.; pin, 5 lbs.; knuckle, 46 lbs.

Buckeye Coupler:—The Buckeye Malleable Iron & Coupler Co., Columbus, Ohio.

Drawhead, for freight cars, 156 lbs.; drawhead, with 6-inch shank, for freight cars, 166 lbs.; drawhead, with long shank, for passenger cars, 160 lbs.; knuckle, 46 lbs.; lock, 7 lbs.; lock link, 1/8 lb.; pivot pin for safety attachment, 10 lbs.

Burns Coupler:—Syracuse Iron Works, Syracuse, N. Y. Drawhead, 15 1/2 lbs.; knuckle, 45 1/2 lbs.; lock, 6 3/4 lbs.; pin, 4 1/4 lbs.; pivot pin, 5 3/4 lbs.; knuckle opener, 1 3/4 lbs.

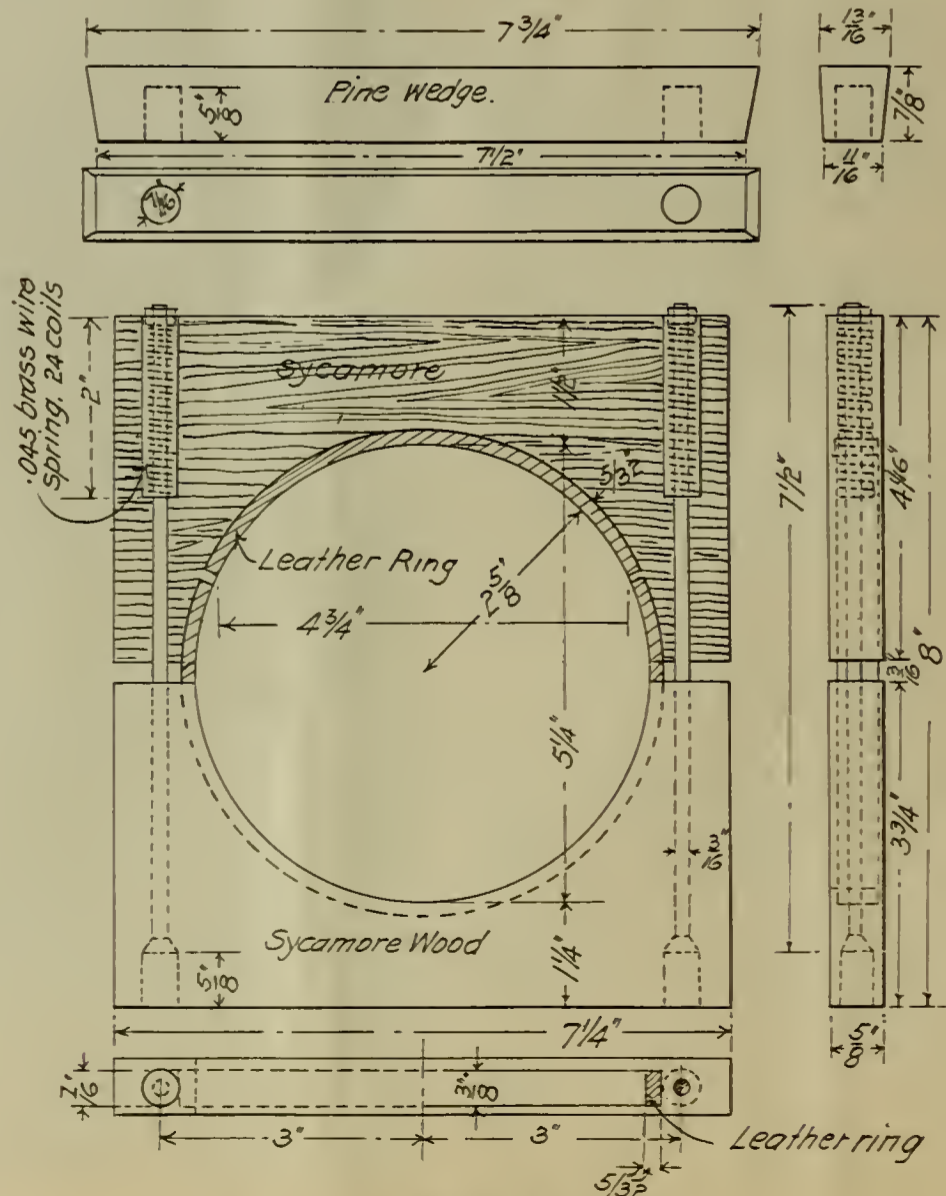

THE HARRISON DUST GUARD.



**Chicago Coupler:**—Latrobe Steel & Coupler Co., Office, Old Colony Building, Chicago, Ill.  
**Freight Car Coupler:**—Drawbar, steel, 156 lbs.; knuckle, steel, 54 lbs.; locking arm, steel, 9 lbs.; pivot pin, steel, 6 lbs.; lifting pin, steel, 3 lbs.  
**Passenger Car Coupler:**—Drawbar, steel, 190 lbs.; knuckle, steel, 55 lbs.; locking arm, steel, 9 lbs.; pivot pin, steel, 6 lbs.  
 The weight of the Chicago Coupler varies with the type of shank used:  
 Drawbar for M. C. B. Standard Strap Attachment weighs .....154 lbs.  
 Drawbar for M. C. B. Tail-Bolt Attachment weighs .....156 lbs.  
 Drawbar for M. C. B. Combination Shank weighs .....155 lbs.  
 Drawbar for M. C. B. American Continuous Draught weighs .....162 lbs.  
**Columbia Coupler:**—Latrobe Steel & Coupler Co., Office, Old Colony Building, Chicago, Ill.  
 Drawbar, steel, 175 lbs.; knuckle, steel, 48 lbs.; locking pin, steel, 8 lbs.; pivot pin, steel, 6 lbs.  
**Detroit Coupler:**—Michigan Malleable Iron Co., Detroit, Mich.  
 Shank, 160½ lbs.; knuckle, 47¾ lbs.; lock, 8 lbs.; lock lifter, 1½ lbs.; pivotal pin, 7¼ lbs.; lock rivets, ½ lb.; clevis and pin, 1 lb.  
**Drexel Coupler:**—Drexel Railway Supply Co., Rookery Building, Chicago, Ill.  
 Body, 135 lbs.; knuckles, 52 lbs.; lock, 10 lbs.; fulcrum pin, 5 lbs.; clevis, 1 lb.  
**Elliott Coupler:**—The Elliott Car Co., Gadsden, Ala.  
 Coupler skeleton, malleable, 182 lbs.; lock, malleable, 5½ lbs.; knuckle, steel, 41 lbs.; spring, steel, 11-16 lb.; pin, wrought-iron, 5 lbs.; lift, wrought-iron, 1 lb.  
**Erie Coupler:**—Erie Malleable Iron Co., Limited, Erie, Pa.  
 Coupler body, malleable, 150 lbs.; knuckle, steel, 52 lbs.; lock, malleable, and chain, steel, 15 lbs.; knuckle pin, steel, 8 lbs.  
**Forsyth Coupler:**—Ross-Meehan Foundry Co., Chattanooga, Tenn.  
 Shank, malleable, 150 lbs.; lock, malleable, 4 lbs.; lock lever, malleable, 5 lbs.; knuckle, steel, 49 lbs.; knuckle pin, 8 lbs.  
**Gallager Coupler:**—Gallager Coupler & Unlocking Attachment Co., Savannah, Ga.  
**Freight Coupler:**—Coupler head, malleable, 157 lbs.; knuckle, cast-steel, 38½ lbs.; locking dog, malleable, 4½ lbs.; unlocking pin, malleable, 1 lb.; knuckle pin, iron or steel, 5 lbs.  
**Passenger Coupler:**—Coupler head, malleable, 162 lbs.; knuckle, cast-steel, 38½ lbs.; locking dog, malleable, 4½ lbs.; unlocking pin, malleable, 1 lb.; knuckle pin, iron or steel, 5 lbs.  
**Gould Coupler:**—Gould Coupler Co., 66 Broadway, New York.  
**Freight Coupler:**—Head, 175 lbs.; knuckle, 38 lbs.; knuckle pin, 8 lbs.; lock pin, 1 lb.; knuckle lock, 8 lbs.; chain, 2 lbs.  
**Passenger Coupler:**—Head, 209 lbs.; knuckle, 38 lbs.; knuckle pin, 8 lbs.; clevis, 1½ lbs.; nut, ½ lb.; lock, 8 lbs.; lock link, 2 lbs.; lock staple, ½ lb.; spring stems, 1½ lbs.; springs, ½ lb.; lock pin, 1 lb.; clevis pin, ½ lb.  
**Hien Coupler:**—The Railroad Supply Co., Owings Building, Chicago, Ill.  
**Freight Coupler:**—Shank, malleable, 135 lbs.; shank, steel, 140 lbs.; knuckle, 42 lbs.; other parts, 22 lbs.  
**Hinson Coupler:**—Hinson Mfg. Co., Gaff Building, Chicago, Ill.  
 Drawbar head, 160 lbs.; knuckle, 50 lbs.; lock, 7 lbs.; hangers, 3 lbs.  
**Jauney Coupler:**—The McConway & Torley Co., Pittsburgh, Pa.  
**Freight Coupler:**—Coupler casting, 179 lbs.; wrought knuckle, 37.5 lbs.; knuckle pin, 5.5 lbs.; locking pin No. 96, wrought-iron, fitted, 10.5 lbs.; release lever keeper, 1.6 lbs.; release lever lock, 2.4 lbs.; release lever angle, clips and bolts, 1.5 lbs.; clevis and pin, fitted, ½ lb.  
**Passenger Coupler:**—Coupler casting No. 1, 154 lbs.; coupler casting No. 1-P, 158 lbs.; Janney-Buhoup coupler casting No. 1-J-B, 148 lbs.; Janney-Buhoup coupler casting No. 1-J-B-P, 151 lbs.; knuckle No. 2-B, 37½ lbs.; knuckle pin No. 16, 5¼ lbs.; catch No. 3, 5 lbs.; horn No. 130, 2 lbs.; catch lever No. 22, 7½ lbs.  
**Little Delaware Coupler:**—Wilmington Malleable Iron Co., Wilmington, Del.  
 Shank, 144 lbs.; knuckle, 50 lbs.; hinge pin, 5 lbs.; lock, 5 lbs.; lever, shackle and pin, 1½ lbs.  
**Lone Star Coupler:**—The Franklin Steel Casting Co., Franklin, Pa.  
 Shank, 160 lbs.; knuckle, 50 lbs.; lock and link, 10 lbs.; pin, 6 lbs.  
**Ludlow Coupler (Class A):**—Springfield Malleable Iron Co., Springfield, Ohio.  
**Freight Coupler:**—Bar or shank, malleable, 140 lbs.; knuckle, steel, 61 lbs.; locking pin, steel, 6.8 lbs.; hinge pin, steel, 6.8 lbs.; locking pin clevis, malleable, 0.1 lb.; Annulus, malleable, 1.3 lbs.

**Mather Coupler:**—A. C. Mather & Co., 1320 Marquette building, Chicago.  
 Drawbar, malleable, 165 lbs.; drawbar lock, malleable 7 lbs.; knuckle, steel, 35 lbs.; knuckle pin, wrought, 5 lbs.  
**Missouri Pacific:**—American Steel Foundry Co., St. Louis, Mo.  
 Shank, cast-steel, 176 lbs.; knuckle, cast-steel, 50 lbs.; lock, cast-steel, 10 lbs.; hinge pin, wrought-steel, 6 lbs.  
**Murphy Coupler:**—The Marion Car Coupler Co., Marion, Ohio.  
 Coupler body, malleable, 138 lbs.; knuckle, steel, 48 lbs.; knuckle pin, steel, 5 lbs.; lock, malleable, 7½ lbs.; lock pin, malleable, 1½ lbs.  
**National Coupler:**—National Car Coupler Co., Monadnock building, Chicago, Ill.  
**Freight Coupler G-1:**—Coupler, all steel, stem or bar, 146 lbs.; knuckle G-2, 44 lbs.; lock G-3, 9½ lbs.; pivot pin, 5½ lbs.  
**Freight Coupler A-1:**—All steel; bar, 143 lbs.; knuckle A-2, 44 lbs.; lock A-3, 9½ lbs.; lock pin A-4, 2½ lbs.; unlocking lever A-5, 3½ lbs.; pivot pin, 5½ lbs.  
**Perfected Freight Coupler:**—All steel; bar No. 1, 150 lbs.; No. 2, knuckle, 50 lbs.; lock No. 3, 3 lbs.  
 (The National A-2 and Perfected are not manufactured now, except the supplies, G-1 being standard freight coupler.)  
**National Passenger Coupler:**—All steel; bar No. 5-P, without wrought-iron extension, 192 lbs.; M. C. B. knuckle No. 2-P, 44 lbs.; lock No. 3-P, 10 lbs.; side unlocking lever No. 4½-P, 4 lbs.; bottom unlocking lever No. 4-P, 4 lbs. When this coupler is used as Miller M. C. B. combination, add 68 lbs. for Miller knuckle No. 8-P.  
**New York Coupler:**—New York Coupler Co., 120-122 Liberty street, New York.  
 Shank, 155 lbs.; knuckle, 53 lbs.; hinge pin, 9 lbs.; lock, 4 lbs.; lock lever, 1 lb.; lock pin, ½ lb.; shackle and pin, ½ lb.  
**Peerless Coupler:**—Peerless Coupler Co., 20 Broad street, New York.  
 Shank, malleable, 140 lbs.; knuckle, steel, 39 lbs.; knuckle pin, steel, 7 lbs.; lock, wrought, 4 lbs.; lifting lever, wrought, 3 lbs.  
**Pooley Coupler:**—Pratt & Letchworth Co., Buffalo, N. Y.  
 Barrel, 159 lbs.; knuckle, 38 lbs.; dog, 9 lbs.; kicker, 4½ lbs.  
**S. H. & H. Coupler:**—Shickle, Harrison & Howard Iron Co., St. Louis, Mo.  
 Shank, 165 lbs.; knuckle, 51 lbs.; knuckle pin, 6 lbs.; knuckle lock, 14 lbs.; knuckle opener, 3 lbs.  
**Smillie Coupler:**—The Smillie Coupler & Mfg. Co., Newark, N. J.  
 Shank, malleable, 150 lbs.; knuckle, steel, 55 lbs.; No. 8 locking pin, 7.9-16 lbs.; No. 9 pivot pins, 4.11-16 lbs.; lifting chain, clevises, etc., 1.7-16 lbs.  
**Smith Coupler:**—American Steel Foundry Co., St. Louis, Mo.  
 Shank, cast-steel, 150 lbs.; knuckle, cast-steel, 47 lbs.; lock, cast-steel, 10 lbs.; lock lift, cast-steel, 2 lbs.; hinge pin, wrought-steel, 6 lbs.  
**Solid Coupler:**—Michigan Malleable Iron Co., Detroit, Mich.

Shank, 154 lbs.; knuckle, 49½ lbs.; lock, 9¼ lbs.; pivotal pin, 7¼ lbs.; lock-retaining pin, ½ lb.; clevis and pin, 1 lb.  
**Standard Coupler:**—Standard Coupler Co., 26 Cortlandt street, New York.  
**Improved Standard:**—Drawhead, malleable, 140 lbs.; knuckle, forged-steel, 66 lbs.; locking pins, forged-steel, 7½ lbs.  
**Standard:**—Knuckle, cast-steel, 55 lbs.; locking pins, forged-steel, 10½ lbs.  
**St. Louis Coupler:**—St. Louis Car Coupler Co., St. Louis, Mo.  
 Drawbar, steel, 143 lbs.; knuckle, steel, 54 lbs.; locking pin, steel, 6 lbs.; pivot pin, steel, 5 lbs.  
**Talbot Coupler:**—American Steel Foundry Co., St. Louis, Mo.  
 Shank, cast-steel, 176 lbs.; knuckle, cast-steel, 50 lbs.; lock, cast-steel, 10 lbs.; hinge pin, wrought-steel, 6 lbs.  
**Thurmond Coupler:**—I. G. Johnson & Co., Spuyten Duyvil, New York City.  
 Drawhead, malleable, 143 lbs.; knuckle, steel, 47 lbs.; lock, steel, 10 lbs.; pivot pin, wrought-steel, 5 lbs.  
**Tower Coupler:**—The National Malleable Castings Co., Cleveland, Ohio.  
**Freight Coupler:**—Coupler Head, 145 lbs.; knuckle, 53 lbs.; lock, 10 lbs.; pivot pin, 6½ lbs.; chain, 1¾ lbs.; clevis, ¾ lb.  
**Trojan Coupler:**—The Trojan Car Coupler Co., Troy, N. Y.  
**Freight Coupler:**—Drawhead, casting only, 135 lbs.; knuckle, 50 lbs.; operating rod, 5 lbs.; knuckle pin, 5 lbs.; finger, 2¼ lbs.; knuckle lock, 13 lbs.  
**Williams Coupler:**—Dyer Williams, 1425 Monadnock building, Chicago, Ill.  
 Bar, 148 lbs.; knuckle, 40 lbs.; lock, 4 lbs.; other small parts, 6 lbs.  
 The Ajax, California, Champion, Diamond, Edwards, Empire, Eureka, Interstate, Johnston, Pacific, Taylor and Washburn Coupler Companies were asked to quote weights, but failed to respond.

THE Q & C CO. AT THE OMAHA WORLD'S FAIR.

The Q & C Company is handsomely represented at the Trans-Mississippi Exposition at Omaha, Neb., as our reproduction from a photograph of its exhibit shows. Among the different devices which this company has on exhibition are: Q & C brake shoe keys; Q & C journal box lids; Q & C shop saws; Q & C freight car doors, with car seal lock; Bryant rail saws; compound lever jacks; Servis tie plates; Q & C pneumatic oil system; Q & C Scott boiler feeder; Q & C Stanwood car steps. It will be seen that these specialties are most attractively arranged. Mr. Jesse Whittall is the company's representative at the exposition. The company has had numerous inquiries, in regard to the different devices named above, and also a number of orders from parties having seen its exhibit.

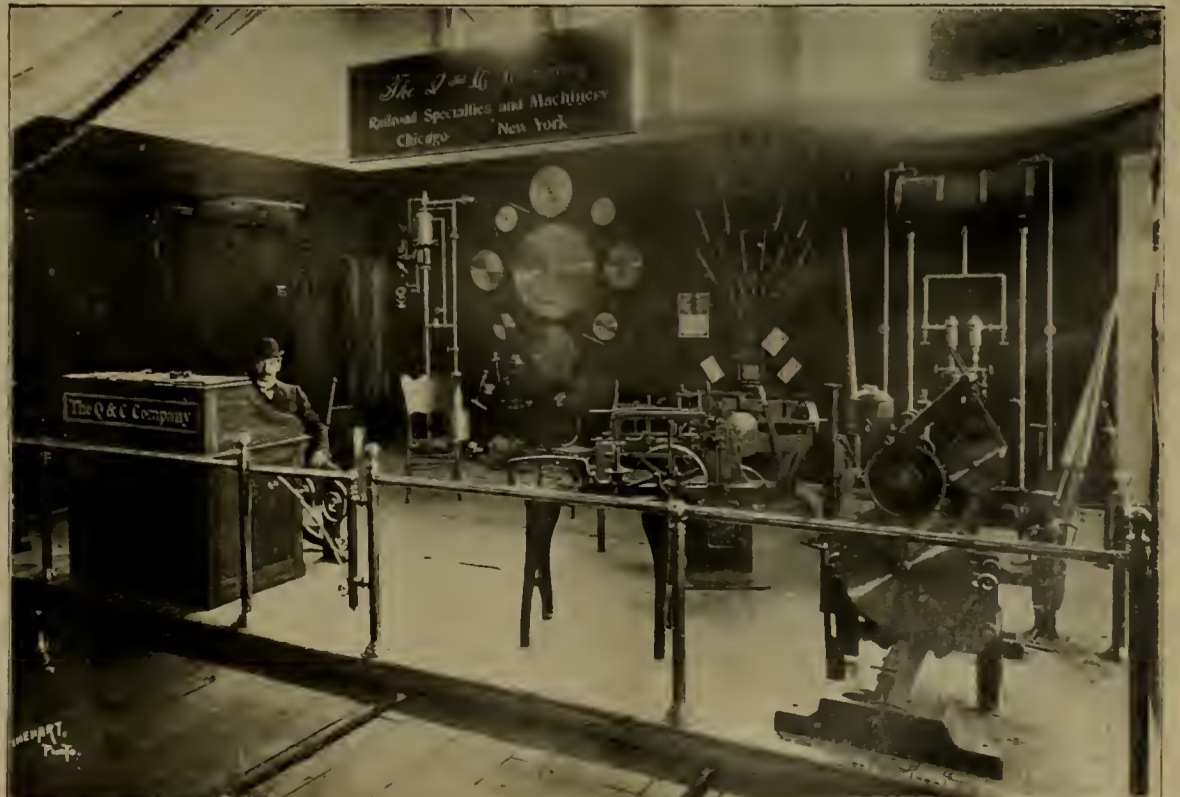

THE Q & C EXHIBIT AT THE OMAHA WORLD'S FAIR.

## AMERICAN RAILWAY STATISTICS.

American railway statistics have been brought down to June 30, 1897, by the statistician's department of the Inter State Commerce Commission. It appears that the total railway mileage in the United States on that date was 184,428.47 miles, there being an increase of 1,651.84 miles, or 0.90 per cent during the year.

Excepting yard track and sidings of which there were 46,221 miles, about 32 per cent of which are laid with iron rails, substantially 95 per cent of the railway tracks in the country are laid with steel rails.

The total number of locomotives in service on June 30, 1897, was 35,986, the increase in number as compared with the preceding year being 36. Of the total number of locomotives reported, 10,017 were classed as passenger locomotives; 20,398 as freight locomotives, and 5,102 as switching locomotives. The number of locomotives not classified was 469. The total number of cars of all classes reported in service on the date named was 1,297,480. The corresponding number for the previous year was 169 greater. Of the total cars reported, 33,626, or 2.3 more than for 1896, were assigned to the passenger service; 1,221,730 were assigned to freight service, indicating a decrease of 157 during the year; and 42,124 were assigned to the special service of the railway companies.

From summaries which indicate the density of equipment and its efficiency in the transportation of passengers and freight, it is observed that during the year ending June 30, 1897, the railways in the United States used 20 locomotives and 708 cars per 100 miles of line. Taking the United States as a whole, it appears that 48,861 passengers were carried and 1,223,614 passenger-miles accomplished per passenger locomotive, and correspondingly there were 36,362 tons carried and 4,664,135 ton-miles accomplished per freight locomotive. All of these items show a decrease as compared with those of the preceding year. The number of passenger cars per 1,000,000 passengers carried during the year under consideration was 69, and the number of freight cars per 1,000,000 tons of freight carried was 1,647. It should be understood, however, that this average does not include such cars, mainly in the freight service, as are owned by private parties, for the use of which the railways paid during the year approximately \$11,000,000.

Including in the term equipment both locomotives and cars, it is found that the total equipment of railways on June 30, 1897, was 1,333,466. These figures are 133 less than on June 30, 1896. Of this total number 525,286 were fitted with train brakes, the increase being 76,432; and 678,725 were fitted with automatic couplers, the increase in this case being 133,142. These increases are somewhat smaller than the corresponding increases for 1896. It should be noted, however, that the number representing the increase in equipment in that year was over 27,000. Further details as to equipment on June 30, 1897, show that the number of passenger locomotives fitted with train brakes was 9,800, or 83 more than the preceding year. The number of freight locomotives so fitted was 18,796, or 875 more than the preceding year. The number of switching locomotives fitted with train brakes was 3,666. The number of passenger locomotives fitted with automatic couplers was 4687, the increase with respect to 1896 being 184. The number of freight locomotives fitted with automatic couplers was 4,192, the increase being 819. The number of switching locomotives fitted with such couplers was 741, or 147 more than for 1896. The number of passenger cars fitted with train brakes on June 30, 1897, was 33,078, and the number fitted with automatic couplers was 32,661, the increase in the one case being 665 and in the other 815. The number of cars in freight service fitted with train brakes was 453,688, or 74,630 more than on June 30 of the previous year. The number fitted with automatic couplers was 629,399, indicating an increase of 129,166. Of the total cars in service 492,559 on June 30, 1897, were fitted with train brakes, and 668,937 were fitted with automatic couplers, the increase for the year in the former case being 75,237; in the latter, 131,980.

The number of men employed by the railways of the United States on June 30, 1897, as reported, was 823,476. These figures, assigned on the mileage basis, show that 449 men were employed per 100 miles of line. The corresponding figures for the year ending June 30, 1896, were slightly larger. The em-

ployes of railways are divided into 18 classes. The number of station agents as reported for the date named was 30,049; other station men, 74,569; engine-men, 35,667; firemen, 36,735; conductors, 25,322; other train men, 63,673; switchmen, flagmen, and watchmen, 43,768, and telegraph operators and dispatchers, 21,452. A distribution of employees corresponding to the four principal divisions of the classification of operating expenses shows that general administration required the service of 31,871 employees, or 17 per 100 miles of line; maintenance of way and structures, 244,873, or 134 per 100 miles of line; maintenance of equipment, 160,667, or 88 per 100 miles of line, and conducting transportation, 378,361, or 206 per 100 miles of line. This statement disregards a small number of unclassified employees amounting to 7,704.

## THE BARTOW BELL RINGER.

The Bartow locomotive bell ringer, which has been in use for about two years on several railways in the East, is now being placed on the market by the Chicago Pneumatic Tool Co.

In this device the motor for ringing the bell has no direct connection whatever with the bell, the crank of the bell shaft having a roller which works over the disc shown on the motor. The valve is operated from an arm, extending from the piston rod to the valve rod; two adjustable nuts, one above and one below this arm, adjust the length of the stroke of valve. This also regulates the speed at which the bell is rung.

There are very few parts to this bell ringer, and in the two years' service it has been in, there have been no repairs. It is easily placed on the engine by a small bracket on the bell frame. The simplicity of the machine can be easily seen, also the economy in running it, the stroke being very short, and only 1 3/4 in. in diameter. It is operated by air from the main reservoir on the engine, and is rung from a valve placed in the cab.

It has been shown that on an engine equipped with a bell ringer, the saving in consumption of fuel has been enough in one month to pay for the device. The explanation of this is that the fireman has so much more time to attend to the firing of the engine, instead of looking out of the window and watching for crossings to ring the bell.

## PERSONAL.

Mr. I. O. Nicholas has been appointed master mechanic of the Tolna & Tenango, vice E. W. Knapp resigned.

Mr. S. C. Boutelle has resigned as master mechanic of the San Diego Pacific Beach & La Jolla, on account of ill health.

Mr. F. O. Emerson has been appointed master mechanic of the Louisiana & Northwest, with headquarters at Gibsland, La.

Mr. J. N. Weaver has resigned as master mechanic of the Pennsylvania & New York division of the Lehigh Valley at Sayre, Pa.

Mr. William Rees has been appointed general master mechanic of the Inter-oceanic railway of Mexico, with headquarters at Puebla, Mex.

Mr. John O'Hearn has resigned as foreman of the Union Pacific shops at Cheyenne, Wyo., to engage in other business at Granger, Wyo.

Mr. W. I. Hoffecker, who was appointed master mechanic of the Central of New Jersey at Elizabethport, N. J., some months ago has resigned that position.

Mr. A. G. Machesney has been appointed master mechanic of the Cornwall railroad, with headquarters at Cornwall, Pa., to succeed Mr. C. J. Herman, resigned.

Mr. Henry Marsh, Jr., car inspector for the Baltimore & Ohio Southwestern at Carlyle, Ill., has been appointed foreman of the company's car shops at Chillicothe, O.

Mr. R. E. McWilliams has been appointed store-keeper of the Kansas City, Pittsburg & Gulf Railroad, with office at Pittsburg, Kas., to succeed Mr. A. L. Thompson, resigned.

Mr. R. T. Pace, purchasing agent of the Atlanta & West Point and Western of Alabama, has been appointed general passenger agent of those roads, vice John A. Gee, resigned.

Mr. J. S. Gould has been appointed master mechanic of the Ohio Central at the Columbus shops. Mr. Gould has been assistant master mechanic at the Dennison shops of the Panhandle.

Mr. C. G. Herman, who was appointed master mechanic of the Cornwall railroad some months ago, has resigned to accept a position with the Baldwin Locomotive Works of Philadelphia.

Mr. A. L. Studer, master mechanic of the Chicago, Rock Island & Pacific at Trenton, Mo., has been transferred to Chicago in place of Mr. John Gill, who goes to Trenton in place of Mr. Studer.

Mr. Frank Cain has been appointed master mechanic of the Texarkana and Fort Smith, with power to perform all duties pertaining to the office of superintendent of motive power and machinery.

Mr. William Wright, who has been chief draughtsman at the Pennsylvania shops at Altoona, Pa., has been appointed general foreman of the Vandalia shops at Terre Haute, vice T. W. Demorest.

Mr. G. Wirt has been appointed master mechanic of the Louisville terminals of the C. C. & St. L. and Chesapeake & Ohio, to succeed W. A. Bell, who becomes master mechanic of the Wabash terminals at Chicago.

Mr. Frank P. Sargent, grand master of the Brotherhood of Locomotive Firemen, has officially announced to the order that he will retire at the end of his term, having been appointed a member of the industrial commission by President McKinley.

Mr. Charles Butler, for many years foreman of the shops of the Terre Haute & Indianapolis at Effingham, Ill., has been transferred to the shops at East St. Louis, Ill., to succeed Mr. Joseph A. McClelland, who will, it is stated, be transferred to Indianapolis, Ind.

Mr. H. A. Bowen, whose resignation as mechanical superintendent of Swift & Co., we noted last month, has accepted a position with the Bettendorf Axle Company, at Davenport, Iowa. He will have direct charge of the railway department of that company, superintending the manufacture of the Bettendorf brake beam and Bettendorf bolsters.

Mr. Wm. Forsyth, mechanical engineer of the Chicago, Burlington & Quincy Railway, has resigned that position to accept the post of superintendent of motive power of the Northern Pacific Railway. Mr. Forsyth's numerous friends will warmly congratulate him on this long upward step. Mr. Forsyth has had quite an extended experience in railroad service. In early life he was with the Philadelphia & Reading at the Reading shops. It was about 1874, we believe, that he was with the Altoona Iron Company, from which he went about a year later to the Pennsylvania Railroad at Altoona, where he was engaged for some time in special work in the foundry, and also in the testing laboratory. He was later for several years mechanical engineer on the Fort Wayne road. For a long term of years now he has occupied the position of mechanical engineer of the Chicago, Burlington & Quincy road, and has been closely identified with the notable development of the mechanical department of that road. As a careful thinker and cogent writer he has become well known by his contributions to technical literature through the Master Mechanics' Association, the Western Railway Club and the railway press.

Mr. E. M. Herr, superintendent of motive power of the Northern Pacific, has resigned to accept an important post with the Westinghouse Air Brake Company, to be practically, as we understand it, assistant to Mr. Herman Westinghouse, general manager of that company. It is a matter of sincere regret that the railway world is to lose Mr. Herr, but there is a compensation in the fact that he enters a service so intimately connected with railway affairs. At this time it will be of interest to briefly review Mr. Herr's notable career. He served his apprenticeship in the Chicago, Milwaukee & St. Paul shops, and was for several years in the Chicago, Burlington & Quincy, first in the testing department and afterward as superintendent of telegraph and division superintendent. He then returned to the St. Paul road as division master mechanic. He was afterward superintendent of the Grant Locomotive Works. When these works closed he went abroad and spent a long season in careful study of foreign railway methods, particularly, of course, in the motive power and rolling stock departments. Returning he was for a time engaged in special electrical work in Milwaukee, and later went to Russia on a special mission for a Pittsburgh syndicate to investigate the opportunities for loco-

motive building in that country, and upon his report the syndicate undertook this great project. When he returned from this work he was made assistant superintendent of motive power of the Chicago & Northwestern, which position he left in January, 1897, to become superintendent of motive power of the Northern Pacific.

**SUPPLY TRADE NOTES.**

—J. D. McIlwain & Co., of Allegheny, Pa., have taken the agency in the central district for Roberts, Throp & Co.'s specialties in all types of light cars.

—Mr. E. N. Hurley, after eight years of service, has resigned his position as general agent of the United States Metallic Packing Company, of Philadelphia, Pa., to engage in other business.

—Bement, Miles & Co. have in hand some large orders for machine tools, covering eight gun lathes for England, Russia and other countries, and large boring mills, planers and lathes for different foreign points.

—The Shaw Electric Crane Company, of Gaud Rapids, Mich., recently shipped a 50-ton ladle crane to the Nicopol Maripolo Mining and Metallurgical Company, Maripolo, Russia. This is a duplicate of the four sent in 1896.

—The Standard steel platform, manufactured by the Standard Coupler Company, of New York city, is now in use on forty-three railroads in the United States and Canada. This is a phenomenal record for sixteen month's work.

—The Carbon Steel Company, of Pittsburg, received during July orders for boiler and fire box steel for 72 locomotives. In June this concern furnished the boiler and fire-box steel for 82 locomotives, the largest month's business in their history.

—Riehle Bros., of Philadelphia, have sold a 100,000-pound testing machine to the Carpenter Steel Company, and one of the same capacity to the Cooke Locomotive & Machine Company, Paterson, N. J. Riehle Bros. have also sold a telegraph wire testing machine to the Japanese government.

—The receivers of the Bass Foundry & Machine Works, Ft. Wayne, Ind., have transferred the property of the company to the Bass Foundry and Machine Company. The new company will also come into possession of the Rock Run Mining Company, and the Lenoir Foundry Co., of Alabama.

—The Curtis & Co. Manufacturing Company of St.

Louis, Mo., has shipped a car load of air compressors for various foreign points, the latest being a 10x12 air compressor for a leading house in Paris, France. The company has also shipped a number of air hoists to England, Bremen and other places.

—The Gisholt Machine Company of Madison, Wis., has outgrown its present plant and is about to erect a new factory. The location has not yet been fully decided upon, the company now being in correspondence with organizations and individuals in various cities that are desirous of getting new industries located with them.

—Mr. G. Fred Collins, who for years has been connected with Valentine & Co., has, in addition to continuing with them, been appointed eastern representative of the Ewald Iron Company, St. Louis, Mo., manufacturers of the famous Tennessee charcoal bloom stay bolt iron, with headquarters at 57 Broadway, New York city.

—The American Tool Works Company, of Cincinnati, has received an order for 24 lathes, for the United States Projectile Company, Brooklyn, N. Y. The American company has also received an order from Milan, Italy, for 12 engine lathes. It will also furnish a complete outfit for a machine shop for the University of Kansas.

—The Russell Snow-Plow Company, of Boston, Mass., has recently received orders for a Russell Wing elevator snow plow, size No. 2, from each of the following railways: The Michigan Central, the Intercolonial of Canada, and the Flint & Pere Marquette. The plow for the latter road is to be equipped with the Russell air flanger.

—The Manville Covering Company, of Milwaukee, is furnishing covering for locomotive boilers to a number of railroads, and the new additions which have recently been added to the works of the company are well filled with work for this season of the year. The covering made by this company has recently made excellent records in comparative tests.

—Williams, White & Co., builders of forging machinery, Moline, Ill., have more bulldozer orders than they can fill with any degree of promptness. Among them are three of the large No. 6 bulldozers and one mammoth No. bulldozer. They have orders from one concern for five bulldozers, two multiple punching and shearing machines, one eye bending machine and two riveting presses.

—The Hilles & Jones Company, Wilmington, Del., have completed for the Harlan & Hollingsworth Com-

pany a set of special bending and flanging rolls, 20 ft. 6 in. between housings; the top roll is 23 in. in diameter, and the bottom rolls 20 in. in diameter; they are driven by duplex engines. The weight is about 150,000 pounds. It will be used to roll and bend iron and steel plates for the hulls of vessels.

—The Ingersoll-Sergeant Drill Company has just completed the installation of an air compressor in the works of the Lassig Bridge & Iron Works of Chicago. This is a Duplex Corliss compressor with steam cylinders 20x30 and air cylinders 30¼ and 18¼x30. The compressor is to be used for running riveters, hammers, hoists, etc. In the Lassig plant all the machines are driven by either electricity or air and no line shafting whatever is used.

—The Chicago Pneumatic Tool Company has just received a second order for its tools from the Imperial Chinese Railway, and president J. W. Duntley of the company is in New York city closing an order from Japan for 36 pneumatic tools and three compressors. We have this information from the company under date of August 22, and the letter adds: "Our mail today covers also many home orders including the United States Navy Yard and the outlook for business is very bright indeed."

—The Sargent Company's open hearth steel plant has been running for the past few months at its fullest capacity on several large contracts, among which may be mentioned the castings for 10-inch gun carriages for the United States government. The Sargent Company has been very successful in this class of work, readily meeting the physical tests prescribed by the government, as well as the short delivery which is demanded in most cases. The good record that they have been making is taken as an indication that they will obtain their full quota of this class of work in the awarding of future contracts.

—The Harrison Dust Guard Company of Toledo has had its guard in service for over three years. It is now in use on the Southern, Lake Shore & Michigan Southern, Seaboard Air Line, Wheeling and Lake Erie, Jacksonville, Tampa & Key West, Florida Central & Peninsular, Toledo, St. Louis & Kansas City, and forty other lines. Over 4600 new refrigerator and freight cars were equipped with it in 1898. During the month of August the company has filled orders for the C. I. & L. Ry., the Lima Locomotive & Machine Company, the Southern Railway, Toledo & Ohio Central Road, Lake Shore Railway (at Cleveland, Buffalo, Adrian and Chicago shops), Michigan Peninsular Car Company, and Ohio Falls Car Manufacturing Company.

Important to Railroad Managers and Master Mechanics.

**SIBLEY'S Perfection Valve Oil.**

More perfect valve lubrication and entire freedom from corrosion or honeycombing of cylinders, and destruction of joints of steam chests by fatty acids.

In Exclusive Use on Nine-Tenths of the Railroad Mileage of the country.

Reference furnished upon application.

MAKE EXCLUSIVE SPECIALTY OF VALVE AND SIGNAL OILS FOR RAILROAD USE.

**SIGNAL OIL CO.,**

FRANKLIN, PA.  
J. C. SIBLEY, President.



**THE NEW "NATHAN" AND MONITOR INJECTORS FOR LOCOMOTIVES.**

"Nathan" Sight-Feed Lubricators For Cylinders and Air Brakes.

STEAM FIRE EXTINGUISHERS for Switching and Yard Engines.

BOILER WASHERS, BOILER TESTERS, ROD AND GUIDE OIL CUPS, ETC.

**NATHAN MANUFACTURING CO.,**

92 and 94 Liberty St., NEW YORK. 147 & 149 Van Buren st., CHICAGO.

**Galena Oil Co. FRANKLIN, PA.**

CHARLES MILLER, President.

Galena Oils are the Standard Railway lubricants of America.

Galena Oils are used exclusively on nineteen-twentieths of the total railway mileage of the United States, Canada and Mexico.

Galena Oils lubricate the fastest trains of the world, and hot bearings as a result of defective lubrication are unknown to the patrons of the Galena Oil Company.

Galena Oils are manufactured exclusively by GALENA OIL CO.

Principal Office and Works: Franklin, Pa.

**THE GRAVITY CAR COUPLER.**

AN ABSOLUTELY AUTOMATIC COUPLER.

Cuts the Cost of the Vertical Plane Type in Two.

THIS COUPLER takes the ordinary Link. Is always ready to couple. Works on heaviest curves. Gives a center draft. Is compact, light and strong.

The latch cannot jump up, or creep up, and release link by motion of the cars.

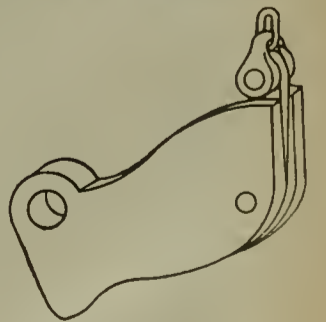

The Latch.

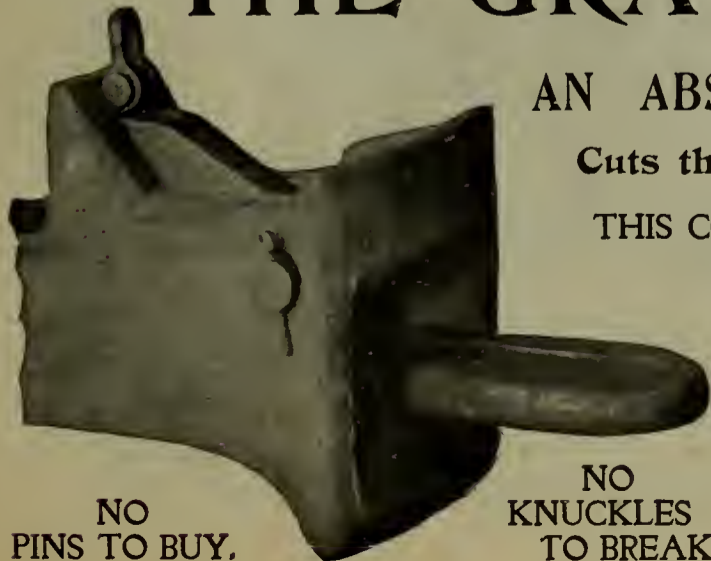

NO PINS TO BUY.

NO KNUCKLES TO BREAK.

IT HAS STOOD THE SEVEREST SERVICE TESTS IN MOUNTAIN AND YARD SERVICE FOR MONTHS. WEIGHT, COMPLETE, 145 LBS.

For details address

**The Gravity-Car Coupling Co.,**

Colorado Springs, Col.

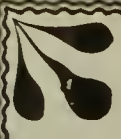

# The Westinghouse Air-Brake Company

is now prepared to fill orders at an hour's notice for one or one thousand sets of **AIR-BRAKES FOR FREIGHT CARS**, having at their new works an annual capacity for turning out air brakes for

**250,000 FREIGHT CARS**  
**6,000 PASSENGER CARS**  
**10,000 LOCOMOTIVES**

Besides repairs for the 650,000 freight and Passenger Cars and 33,500 Locomotives already equipped by



# The Westinghouse Air-Brake Company

**RAILWAY MASTER MECHANIC**

**WALTER D. CROSMAN, Editor.**

**EDWIN N. LEWIS, Manager.**

PUBLISHED MONTHLY BY

**THE RAILWAY LIST COMPANY.**

Devoted to the interests of railway motive power, car equipment, shops, machinery and supplies. Communications on any topics suitable to these columns are solicited.

Subscription price, \$1 a year, to foreign countries \$1.50, free of postage. Advertising rates given on application to the office, by mail or in person. Address

**THE RAILWAY LIST COMPANY,**

The Rookery, Chicago, Ill.

*The Official Railway List is Published by this Company.*

**VOL. XXI. CHICAGO, OCTOBER, 1898. No. 10.**

The traveling engineer, or, as he is sometimes known, the road foreman of engines, has a most peculiar, and, it might be said, a most particular position to fill, the duties of which are of a nature quite different from those in any other position, except that of traveling firemen on a railroad. The Traveling Engineers' Association held its sixth annual convention in Buffalo, beginning September 13, and one of the questions discussed was: "How Can the Traveling Engineer Best Instruct and Assist the Fireman in the Economical Firing of the Locomotive?" Unfortunately for the traveling engineer, he is supposed to be thoroughly informed on the air brake and the handling of the same, and be capable of giving instruction in the same; he is supposed to know all about the different kinds of coal used and the best methods of firing each, and to be capable of demonstrating his "theories" to the satisfaction of the fireman and the engineer; to be able to diagnose at once the various ailments of lubricators, pumps, injectors, valves and other parts, and to locate "blows," "pounds" and other noisy indications of needed attention without waiting for close examination; and he must be able, sometimes "physically" as well as in other ways, to show the engineer that he can run the engine better than the regular engineer can run it, even though both were "set up" at the same time. Consider further that the men under his supervision frequently are so widely scattered and so numerous that he can see each one only twice or three times a year, if he keeps moving as rapidly as possible, and that he is subject to immediate call from the superintendent or master mechanic to take up some special investigation or for some special service, and the wonder is that the traveling engineer has any time to devote to firemen.

The question arises as to why this traveling engineer should devote any time to the fireman, "assisting" him in economical firing? There should be on every locomotive while in service a man competent to take complete charge of it and who must assume entire responsibility for the service rendered by it; it is obvious that this man is the engineer and he should be held responsible for the satisfactory working of the machine from coal pile to exhaust tips just as is the stationary engineer, and it is with him that the traveling engineer should come in contact directly. The traveling engineer would do well to bring about such conditions; the fireman will then be "set up" because he knows how to fire and how to "assist his fireman in the economical firing of the locomotive" as well as because he knows how to handle the machinery, and the traveling engineer will have lifted one load from his own shoulders and placed it where it belongs. The general conditions now are that the engineer accepts responsibility from the time the steam is supplied and if the supply is not sufficient to meet any demands the engineer can make no contents himself with making sly reports to the

foreman or master mechanic; no objection is made to any over supply which may escape through the safety valve. It was recommended in the report referred to that the traveling engineer ride with new firemen until they are thoroughly competent to do their work, but this is just the time, when the new fireman comes on, for the engineer to show what he knows and to assume command of the entire machine. The discussion rather blamed the draft appliances for waste of fuel: this is only partly correct; it is the lack of the proper manipulation of the draft appliances which causes much waste of fuel; and because of the fact that ash pan dampers are so seldom manipulated by the fireman it is almost a question whether it is worth while to provide those appliances.

Uniformity of cab fittings was one of the subjects considered at the recent meeting of the Traveling Engineers' Association, and in referring to it here the intention is merely to offer a few suggestions for guidance in interpreting the recommendations. There can be no question about the advantages of using a combination stand on the boiler head and so supplying the various appliances through one hole in the boiler shell, but it too frequently happens that the opening in the combination stand is smaller in area than the combined area of the passages outside of the combination stand, and then more or less trouble is experienced with the injectors and pump. The combination stand should be of liberal size and the passage between it and the boiler should be of ample area; further, the stand should be so designed and placed that the various pipes shall lead from it with as few bends and angles as possible between it and the attachment to be supplied with steam. There should be also, a check so placed that in case the stand is knocked off the check will prevent the flow of steam from the boiler.

It was argued that the throttle lever should be placed conveniently to reach when the engineer leans out of the window, but for road engines it is much more important now to place the engineer's brake valve in such a position that its handle can be easily reached. The valve is used more often than the throttle, and at the present time engineers will keep the left hand on the valve, while running, so as to be able to apply the brakes as quickly as possible to prevent impending danger; the valve is used first because there is time after throwing it to the proper position to manipulate the throttle and lever, if the latter is desirable, before the brakes apply strongly.

It is, of course, necessary to arrange everything in the cab as conveniently as possible, not only those parts which are to be manipulated by hand but also those other appliances which are to be seen; with the large boilers now becoming so common it is too apt to happen that the gages are placed all but out of sight and the engineer has much difficulty to see the steam and air gages, while the fireman reads the steam pressure from the safety valve, and fires to keep it always open so that he may know what the pressure may be.

Just as important as the steam combination head is an air combination head from which to lead off the pipe to the various appliances which are now operated by air. If one locomotive should be equipped with every one of the various air devices such as bell ringers, sanders, blow-off cocks, cylinder cocks, ash pan hoppers, reversing gear and others which lack of space prevents mentioning, the air pipe combination stand would be more of a necessity than the combination stand for the steam connections.

**STRENGTHENING THE M. C. B. COUPLER.**

We have had occasion several times of late to refer to the M. C. B. coupler in connection with the complaints that have from time to time been coming to the front as to its alleged inefficiency. We wish to here reiterate our previous expressions of view to the effect that this type of coupler is unquestionably here to stay. The most outspoken opponent of this type of coupler, Mr. Pulaski Leeds, said, it may be remembered, in his paper which

we published last month, that with all its faults we have it still. And as we are going to "have it still" it is not only useless but very undesirable to attempt, at this late day, to cause a turning to some other type. As a matter of fact, the faults of the present type have been greatly exaggerated, and as a further matter of fact the use of this type has permitted very considerable economies in the operation of trains. It has one feature which, if none other were cited, makes it absolutely indispensable in modern railway practice, and that is the elimination which it provides of the loose slack which characterizes the link and pin type of couplers. The fact must not be forgotten that in 1886 the Master Car Builders' Committee, engaged in making brake tests, found that it was not safe to use power brakes on 50-car trains coupled with loose link and pin drawbars. The brake tests had to be made with trains in which the link slack was blocked out; and the necessity for this was so marked that the testing committee absolutely refused to accept for test in its second series of experiments any trains that were not fitted with close couplers. Some other tests made at about the same period showed in actual practical experience that trains from which the loose link slack was eliminated by blocking could be more satisfactorily, more easily and more safely operated over the road than similar trains without the blocking. Proved facts of this nature have given a secure place to the M. C. B. coupler in modern railroad practice.

The thing to be considered now is, as we have before urged, not to seek another type, but to strengthen, as far as possible, the present type. The far greater percentage of failures in this type is, it is well known, in the knuckle. The latter is, of course, materially weakened by the link slot; but the fact should not be lost sight of that this weak feature is not fairly chargeable to the type and is not in any sense a part of that type. It was introduced solely for the purpose of accommodating the link during the transition period from old to new. The time is not far distant when the link and pin coupler will have so far disappeared that this slot can be closed up and the knuckle given its normal strength; in fact, this has already been done in some quarters where it has been possible to run solid M. C. B. coupler trains.

An experimental strengthening of the knuckle at this obviously, and for the immediate present unavoidable, weak point is being made on the Chicago, Burlington & Quincy Railroad, by reducing

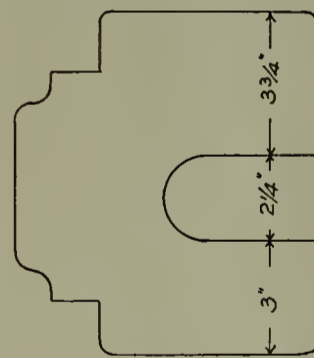

the opening for the link and giving more metal to the lugs. In diagram No. 1 we give an outline of the knuckle face which fairly represents current practice. It will be seen that the upper lug is 3 3/4 ins. deep vertically, and the lower lug is 3 ins. deep vertically, the slot left for the link being 2 1/4 ins. deep. It is proposed to reapportion the metal in the lugs so that, as is shown in diagram No. 2, both the upper and lower lugs will be 3 3/4 ins. deep each, this being done by reducing the link opening to 1 1/2 ins.

A number of couplers made in accordance with this plan are being placed in service on the Chicago, Burlington & Quincy Railroad. The working of these couplers in service will be very carefully watched, and the result will be awaited with very great interest.

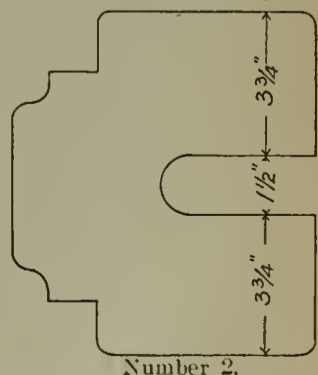

It is not entirely clear, however, that whatever may be gained by this method of strengthening may not be offset by losses in other directions. We refer particularly to the binding effect which would be liable to result from giving the links so little play in the knuckle. The average link is 1 1/4

in. in diameter, some rising, we believe, to  $1\frac{1}{2}$  ins.; but assuming that the link is  $1\frac{1}{4}$  in., and that it is riding in a  $1\frac{1}{2}$  in. opening in the knuckle, it would not require much variation in height of the two drawbars to cause a possibly fatal binding of the link in the slot. It seems very probable, indeed, that a  $1\frac{1}{2}$  in. slot would be found too small. It is true that there has been much good work done of late in bringing cars to a uniform height, but we imagine that most of this work has been done upon cars equipped with M. C. B. couplers and that the cars with the link and pin drawbars have been neglected in this respect, at least upon most roads. It will be generally conceded, we believe, that the present slot of  $2\frac{1}{4}$  ins. is excessive. This dimension was taken, if we recollect aright, solely to provide for pilot bars, and as pilot bars are gradually disappearing the necessity for this dimension in the lug is becoming less. Another point that should be considered in this connection is that breakages of the lower lug, which it is sought to thicken in this new plan, are really not very numerous. We believe that records will show that of the total number of breakages, only 4 per cent, approximately, occur in the lower lug, 96 per cent of the breakages being in the upper lug.

However, the experiments on the Burlington road will be watched with widespread interest as representing an earnest effort in the direction in which every Master Mechanic should be working—that is, the strengthening of the M. C. B. coupler.

#### RESPONSIBILITY FOR CONDITION OF AUTOMATIC LUBRICATORS.

The tube in the automatic lubricator on the left-hand side of an engine broke as the train was leaving a station. Thereupon, the fireman immediately closed the valves but when he did it the stem of one of the valves broke off, so that the valve could not be opened. This prevented the insertion of a new tube and made it necessary to put oil into the cup by hand, at frequent intervals. In consequence of performing this new duty, on a very hot day, the fireman was overcome by heat to which he was thus exposed, and was seriously injured thereby.

In the suit for damages that followed, the charge was that the railway company had negligently and carelessly failed to inspect the lubricating apparatus and to keep the same in repair, in consequence of which negligence the fireman was injured without fault on his part, this contention being largely based upon his testimony that the T or handle of the valve was found to have been half or two-thirds broken off before, as shown by the corrosion he found on it. But the supreme court of Iowa lays down the law against him, holding that a verdict was properly directed for the railway company.

Under the law, says the court, the company was bound to use ordinary care in selecting this lubricator, so as not to subject its employes to unreasonable danger. It was also bound, as such appliances may in time become out of repair, to exercise ordinary care in inspecting and repairing the appliance, so as to keep it fit to be used.

The only consequence that could reasonably have been anticipated to follow a break of the valve stem, continues the court (case of Stockwell against the Chicago & Northwestern Railway Company), were these: That if broken when the valve was open, so that it could not be closed, steam and oil would be injected into the cab until the steam was shut off from the engine; and, if broken, as it was, when the valve was closed and out on the road, the oiling would have to be done by hand, through the cups. Surely, the most prudent person would not have anticipated that the occasional occurrence of the breaking of the glass tube and the breaking of the valve stem would have occurred at a time when the combined heat of the day and that from the boiler would have rendered oiling by hand dangerous.

Where only such consequences as those above named were to be expected, the court maintains, ordinary care did not require the same diligence in inspecting as where the defects were more liable to occur, and where actual danger might reasonably be expected. This lubricator was under the constant observation of this fireman, and, in part at least, under his care, and he could have discov-

ered the defect in the valve stem as readily as any other person. And, though it be conceded that he was not charged with the duties of inspecting the lubricator, yet certainly the company had a right to assume that he would report any defects therein observed by him, and that, none being reported, he had not seen any.

For the reasons thus explained at length the court declares that it could not be said that, as to this fireman, the company was negligent in not discovering and repairing the stem of this valve.

Moreover, the court holds that, under the rule that, in accepting employment as a fireman, the party suing assumes the ordinary risks incident to that employment, he assumed the duty of oiling by hand whenever occasion required it, whether the day was hot or cool, and that exposure to the heat was one of the ordinary risks of the employment.

On the other hand, it being the fireman's duty to oil by hand when, from any cause, the lubricator failed to operate, and he having done so in the proper manner at this time, he was not guilty of any negligence contributing to his injury in doing the oiling. Whether his failure to report that the T of the valve was bent, which he knew for some time, or to examine it to see whether or not the stem was broken was such negligence on his part as to defeat a recovery of damages, the court avoids expressing an opinion on.

#### 100,000 POUNDS STEEL COAL CAR, NORTHERN PACIFIC RAILWAY.

Some time prior to his relinquishment of the post of Superintendent of Motive Power of the Northern Pacific Railway Mr. E. M. Herr addressed himself to the task of designing a double hopper bottom coal car of 100,000 pounds capacity. The cars of this nature which had in the east given satisfaction generally were not suited to his requirements for the reason that they could not be loaded with western coals to their capacity of 100,000 pounds because they lacked the cubical capacity. Mr. Herr therefore designed the car which we now illustrate, and had a sample car built according to this design by the Gillette & Herzog Company, of Minneapolis. There has been obtained a car which, while only 30 ft. long, will carry 100,000 pounds, has a capacity of 1740 cu. ft., and weighs only about 35,000 pounds, and which, moreover, is built of commercial shapes. We give elevations, plans and sections of this car, and also a perspective of the metallic skeleton of the car, taken prior to its being fitted with its wooden linings. We also give the truck of this car in some considerable detail.

This car is 30 ft. long over sills and 9 ft. 6 ins. wide over sills. The height of its body is 7 ft. 9 ins., and the height of the car from the rail to the top of the plate is 10 ft.  $4\frac{3}{4}$  ins. The distance from center to center of truck is 20 ft. 8 ins.

The center sills are of the box girder type and are made of 15 in. channels weighing 33 lbs. per ft., and having 7-16 ins. by 21 in. plate at top and bottom. The side sills are made of 15-in. I-beams, weighing 50 lbs. per ft. The end sills are of special Z bars,  $2\frac{1}{2}$  and 3 ins. by 5 ins. and 9 ft. 6 in. long; and the dead blocks do not bear on these sills but upon a  $\frac{3}{8}$  in. x  $11\frac{1}{2}$  in. x 2 ft. 10 in. plate, which in turn rests against the ends of the box girdered center sills. The bolsters have top and bottom plates  $\frac{3}{4}$  in. by 10 ins., with a center web  $\frac{3}{8}$  ins. thick, with a  $2\frac{1}{2}$  in. by  $\frac{3}{8}$  in. angles. The center casting is of steel, riveted to the plates and channels. The center plates are of malleable iron. The draft rigging carries double helical springs with malleable iron lugs riveted to the channels. The outer lugs form a support for 9 ins. by  $9\frac{3}{4}$  ins. oak blocks placed back of the dead blocks, which latter are of cast steel.

The frame of the body of the car is made of angles and channels. The posts are of 3 in. by  $2\frac{1}{2}$  ins. angle, weighing 6-10 lbs. per ft. The plate is of 4 in. channel, weighing 8 lbs. per ft. The center braces are of  $2\frac{1}{2}$  in. by 5 in. oak. It will be seen from our photographic view that this whole metallic frame work presents a very neat and thorough job, one withal that is very strong. The vertical sides and ends of this frame work are lined with  $1\frac{3}{4}$  in. Georgia pine, and the sloping ends with a  $2\frac{1}{2}$  in. oak.

The drop doors are made of  $\frac{1}{4}$  in. plate, reinforced with angles, and their hinges are of cast steel and bolted to the under frame. The doors are closed by winding shafts provided with ratchets. When in position they are supported by a  $1\frac{3}{4}$  in. crow foot rod. The dumping rigging is arranged to be operated from either the top or the bottom of the car.

The trucks are of the arch bar type, carrying a swing bolster. The top arch bar is  $1\frac{1}{2}$  by 5 ins., the lower arch bar  $1\frac{3}{4}$  by 5 ins., and the tie bar  $\frac{3}{4}$  by 5 in.. The bolsters of this truck are made of 15 in. channels weighing 48 lbs. to the ft., and are trussed with four  $1\frac{3}{8}$  in. rods. The truck carries 5-group coil springs made of  $1\frac{1}{4}$  in. steel. All detail attachments are made of malleable iron. Steel axles are used, with  $5\frac{1}{2}$  in. by 9 in. journals. The wheels weigh 750 lbs. and are made of chilled cast iron. The Barber type of rollers is used in this

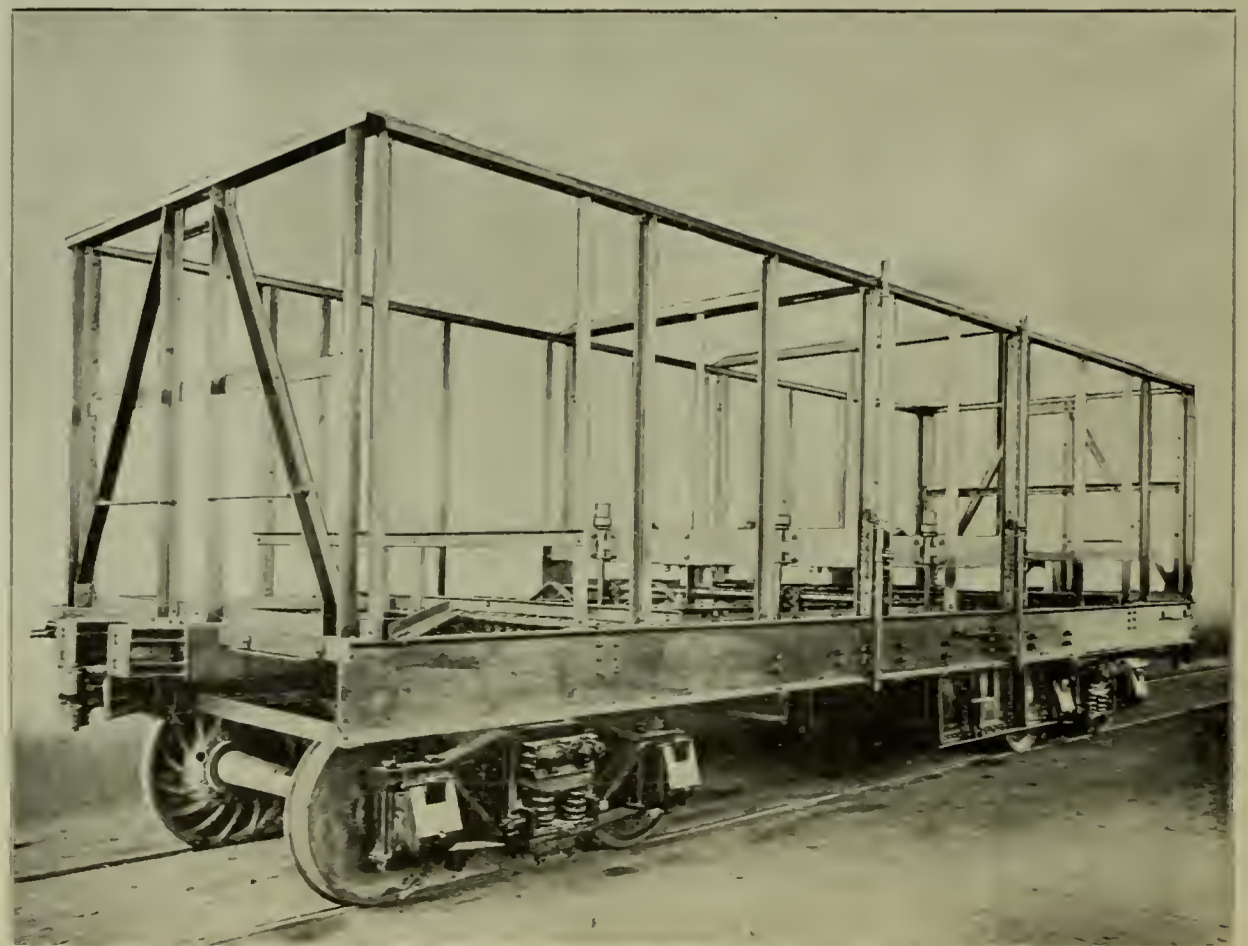

100,000 POUNDS STEEL COAL CAR—NORTHERN PACIFIC RAILWAY—STEEL FRAME.

truck. The Westinghouse quick-acting brake, with independent auxiliary reservoir and brake cylinder is used on this car.

JOINT CAR INSPECTION.

At the April meeting of the St. Louis Railway Club, Charles Waughop, chief joint inspector, East St. Louis, presented a paper entitled "Car Inspection. Past, Present and Future." That paper was published in the RAILWAY MASTER MECHANIC for July, 1898. We now give an abstract of the discussion contributed at the July meeting of that club by John J. Baulch, general freight agent, Wiggins Ferry Company, and R. H. Johnson, M. M. and M. C. B., A. & W. P. R. R.

J. J. Baulch:—While there is no gainsaying that

not so by the inspection and mechanical department of the railroad to which we delivered the cars. The cars were declined and sent back because drawbars were too high, but, notwithstanding that fact, these same cars were ordered into the elevator on our line, were loaded and went forward on the railroad owning the cars.

2. We are continually in receipt of lumber from connecting railroads passed on joint inspection, say on the east side of the river, and held up and sent back by the connecting railroad on the west side. "Load shifted" is the principal cause of complaint, and when joint inspector is called upon his reply is, "Our service covers the car, but not the load," until, in self-preservation, we were compelled to put special inspection on such shipments to avoid expense and delay to the intermediate handler of the freight.

3. Oil in tanks is passed by joint car inspector on one side of the river as fit to run, and, with no increase

where a car load of Kansas corn had sprouted and raised the second crop within the car while the knights of the pencil wrestled with might and main over the probabilities of a wheel being worn through chill, or an old slid flat nearly worn out. Then came the determination to make joint inspectors, and in spite of our worthy "doubting Thomases" fears that no man could and would administer for all, the joint inspector has proven a success, and the system, if carried to its full possibilities, will reduce the cost of inspection fully 50 per cent and delays to freight will become a thing of the past.

With regard to M. C. B. rules, we have always held they were too many in number, not explicit, and that one virtually kills the other. The questions on interchange are decided by decisions of the arbitration committee, and I am free to say that it is astonishing what a multitude of sins these decisions are stretched to cover, until one is led to believe there is no end to their elasticity.

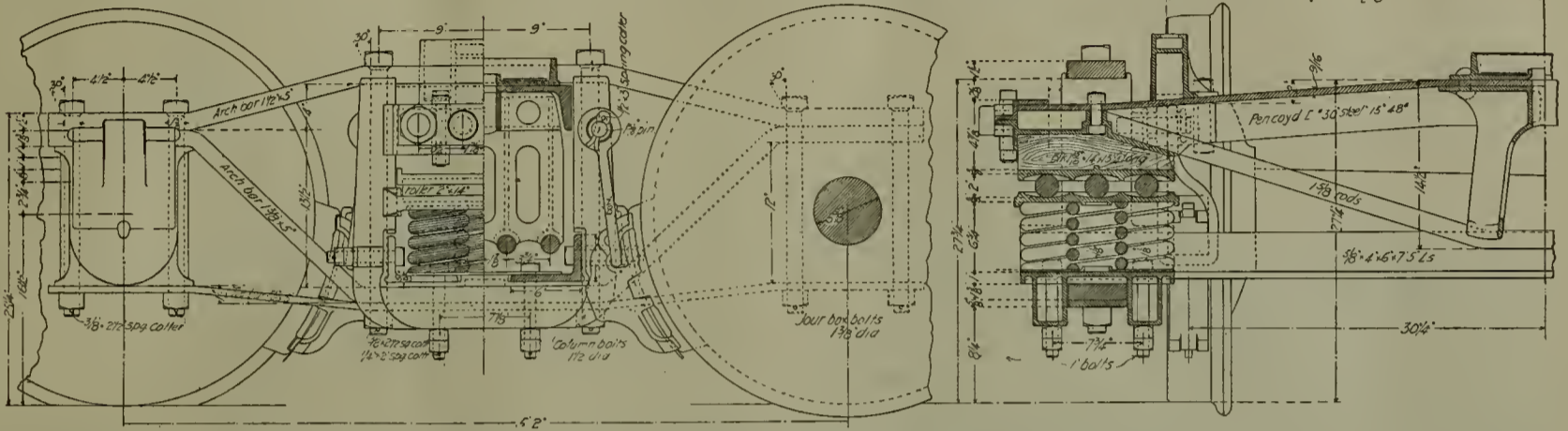

100,000 POUNDS STEEL COAL CAR—NORTHERN PACIFIC RAILWAY—THE TRUCK.

joint car inspection has removed many obstacles, vastly improved the service, quickened the movement of equipment, loads and empties, especially at large terminals, and has lightened the troubles of the traffic officer very materially by reducing the number of tracers for delay, and the consequent undesirable correspondence between railroad officials and shippers and consignees, and has enabled the claim department to better locate damage claims, and in many other details has been of material assistance to the traffic department, especially on terminal properties, yet that there are defects in this joint inspection cannot be disputed. I have in mind several cases which show the necessity of a better code of rules or a rigid revising of those now in force. Some of the defects of our present system coming under my notice are:

1. A batch of new cars delivered by one of its connecting railroads to our company to be switched to another connecting railroad for loading back to owners. The cars, being new and filling all requirements of the law, etc., were passed by joint inspector, but

in defects, is "held up" or set back by connection "order of mechanical department."

The chief joint car inspector's jurisdiction and authority should be extended to cover such points. He should be able to give orders that could not be impeached by local authorities, and while it would increase his responsibilities, it would result in good to the service and the competency of the inspection would and could not be questioned, except before the executive committee.

R. H. Johnson:—It is a lamentable fact that as business increased, so did M. C. B. rules multiply, so did car inspectors, and as car inspectors and pay rolls swelled in numbers and amount, so did car detention; and as complaints from delayed freights deluged the mechanical department from the traffic managers, more inspectors were added. This addition but stimulated inspectors to devise ways and means to down the other fellow before he could down me. Pencil, clip and argument were in great demand; so much so that it has been said that there is an instance on record

I cannot see any way out unless a decided stand is made that all loaded cars shall be accepted and repaired by the receiving roads. Bill owners for their part of repairs made necessary by deterioration, broken, damaged or lost parts in fair service, which can be defined as they are to-day in the M. C. B. rules, only not quite so severe. Bill delivering companies for such parts that show they were damaged by rough handling, as explained by M. C. B. rules for that purpose, showing each by working card that is applied what has been done. Increase the price of labor 15 or 20 per cent for such repairs, so that it will be more profitable for owners to do their own work than to allow cars in an indifferent condition to get away in interchange after reaching the home road. This will encourage all roads to keep up foreign cars, resulting in good both ways, for it is a recognized fact that fully 25 per cent of the rolling stock of this country is non-producing, being held for repairs on rip tracks or at shops. Therefore, any steps taken that will prevent loss of mileage to rolling stock will tend to increase

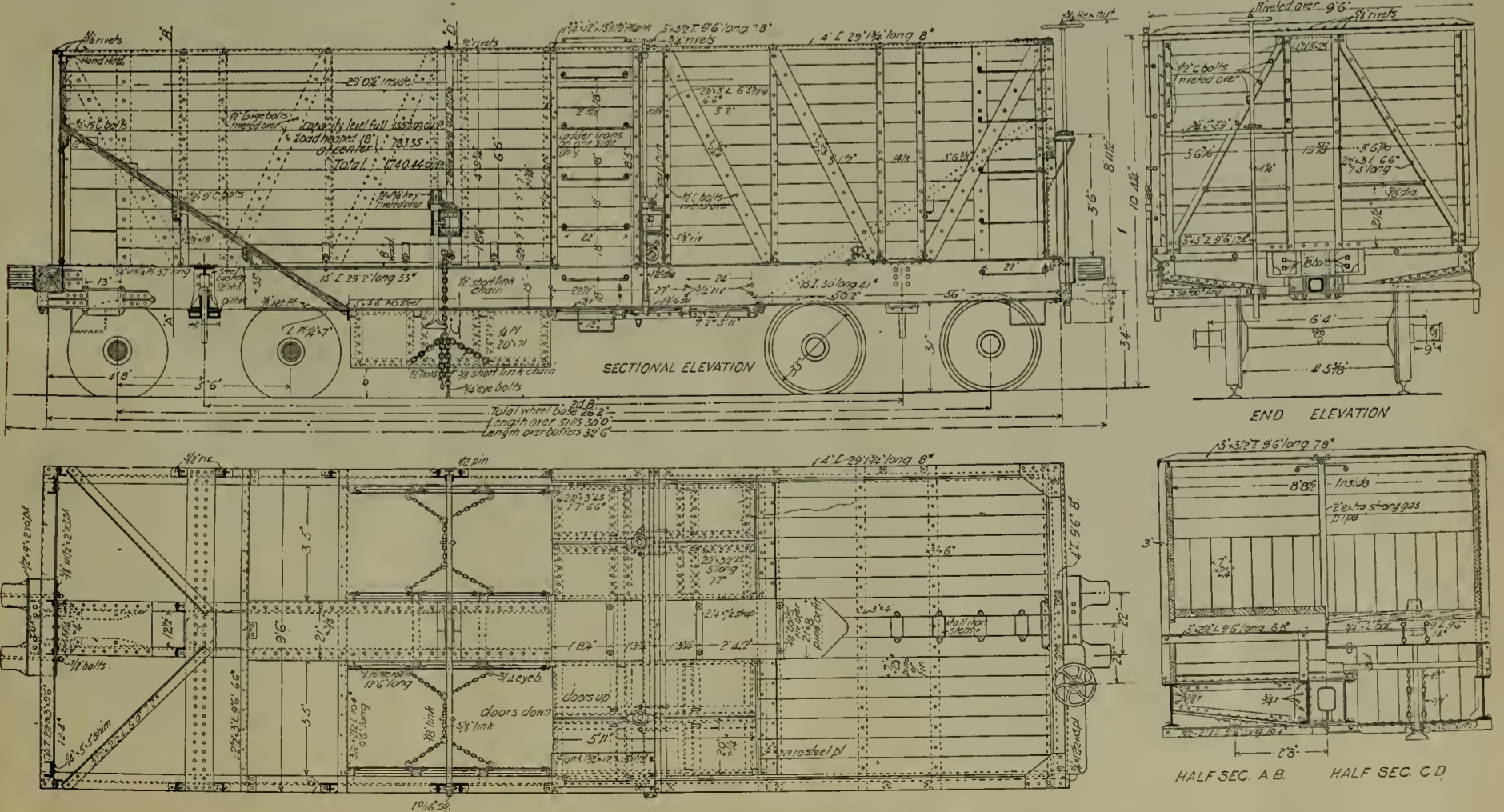

100,000 POUNDS STEEL COAL CAR—NORTHERN PACIFIC RAILWAY—ELEVATION, PLAN AND SECTION.

earnings by giving larger returns on the capital invested, and will save making still larger investments in rolling stock.

I believe there are enough large-hearted managers and superintendents of rolling stock who will say, "Let us place all inspectors at interchange points under one man, let the foreman of repair tracks inspect every train as it comes in off his road, mark what is to be done to loads to make them safe and mark empties to the repair track for needed repairs; there his repair force can soon return the cars to the main line, while the joint man will attend to the exchanging of loads." The joint inspector being independent of all roads, his position will depend on the justice of his actions and the rapidity with which he moves the freight. One inspector can do the work of three, each man

abundant descriptive notes from which we quote freely in the following paragraphs.

These locomotives are especially interesting from the fact that the cylinder proportions are unusual in ordinary practice and they are also provided with an improved form of piston valve. While conforming to the standard practices adopted by the Brooks Works for first class, high grade locomotives, they differ very materially from hitherto conventional practice.

It will be noticed that in many respects the locomotives are somewhat similar in design to those built by the Brooks Works for the Wisconsin Central and illustrated in our issue of June, 1898. But

that the front and back ends are slabbed, the front ends being connected together with a heavy 13 in. channel which forms a backing for the bumper beam, the back ends being also connected by two 13 in. channels of lighter section placed back to back with a  $\frac{3}{8}$  in. vertical plate between them, forming the cab bracket or support for running boards and firing deck, the firing deck being made level with the running boards and the tender floor being also raised up to match, thus forming a flush deck throughout. The fire door is located a convenient height above the firing deck, thus insuring a sufficient depth of fire box at back end below the fire hole and enabling the fireman to carry as



TEN WHEEL PASSENGER LOCOMOTIVE—GREAT NORTHERN RAILWAY.

knowing that it is skill not subtlety, that is at a premium, and car builders will be happy, for then the best car repairers will be returned to the rip track and the \$90,000 expended in St. Louis for inspection will help to turn out more cars in good order and not be allowed to go to waste in pencil and argument, while inspection for safety will be the rule, as it was before 1879.

TEN-WHEEL PASSENGER LOCOMOTIVE—GREAT NORTHERN RAILWAY.

A notable engine, claimed to be the heaviest passenger engine in the world, is illustrated herewith. It is one of eight which have been in service on the Great Northern Railway for the past three months. These engines were designed and built by the Brooks Locomotive Works, in accordance with the ideas of President J. J. Hill, of the Great Northern. The Brooks Works favors us with unusually

while the Wisconsin Central engines weighed only 150,000 lbs., with a maximum draw bar pull of 30,000 lbs., the Great Northern engines illustrated herewith have a total weight of 166,000 lbs. and a maximum draw bar pull of 36,000 lbs., the weight upon engine truck being 36,500 lbs., and upon drivers, 129,500, thus giving a co-efficient of adhesion for the maximum draw bar pull of about 3.6; and when cutting off at 20 or 66 per cent, with a mean effective pressure of 170 lbs., and a draw bar pull of 32,500 lbs., a co-efficient of adhesion of about 4.

The cylinders are 20 ins. diameter, with 30 ins. stroke, the driving wheels 63 ins. diameter, and the engine truck wheels 30 ins. The driving wheel base is 14 ft. 6 in.; engine wheel base, 25 ft. 4 in.; total wheel base of engine and tender, 53 ft. 7  $\frac{1}{2}$  ins.

The frames are 5 ins. wide throughout, except

heavy a fire as desired and yet giving him ample facilities for handling same.

The arrangement of spring rigging is quite similar to that used upon the Wisconsin Central engines, with a heavy cross equalizing spring for the forward drivers. This arrangement was illustrated in our issue of June, 1898, page 76. It has been found in service that this form of spring rigging, with the heavy cross equalizing spring in front, gives most excellent results and produces a remarkably steady and easy riding engine, far beyond the expectations of the designers.

The cylinder arrangement and piston valves are the same as used upon the Wisconsin Central engines. (This arrangement and design was given in our issue of June, 1898.) The piston valves are 12 ins. in diameter, with 7 ins. maximum travel, 1  $\frac{1}{8}$  in. steam lap,  $\frac{1}{8}$  in. exhaust clearance, and 1-16

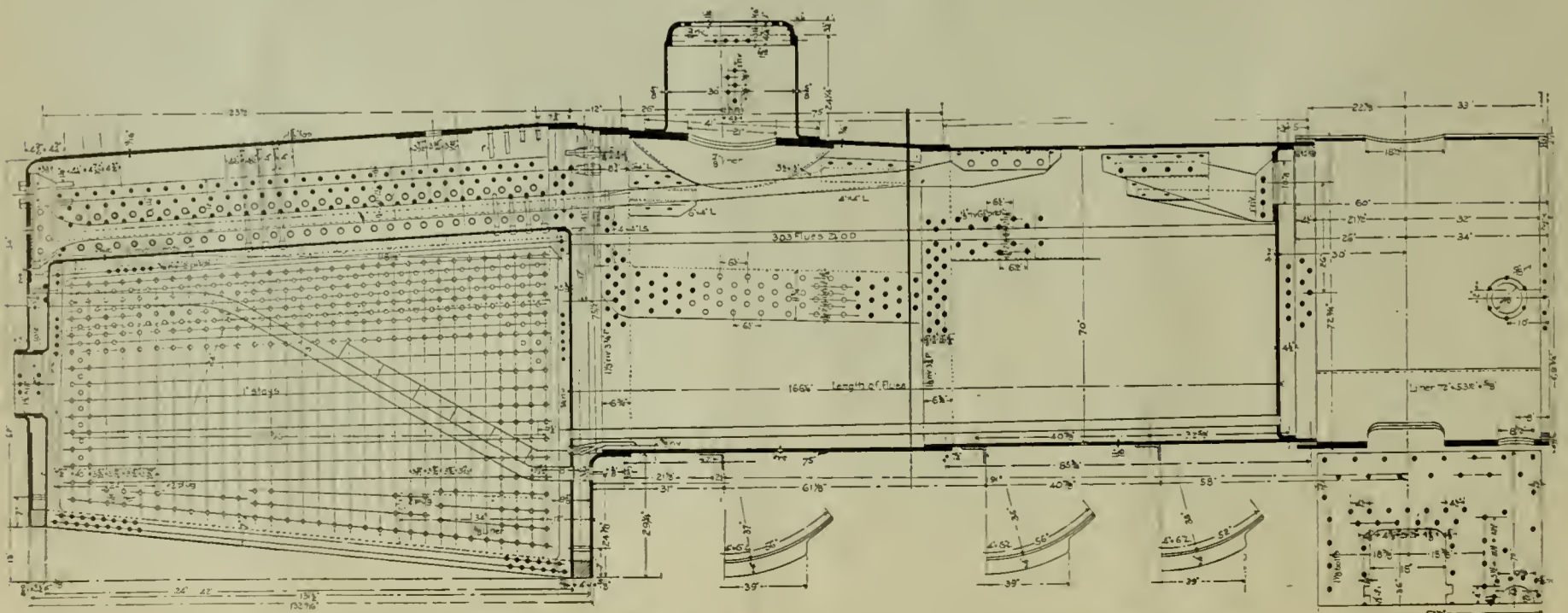

TEN WHEEL PASSENGER LOCOMOTIVE—GREAT NORTHERN RAILWAY—THE BOILER.



In negative lead in full gear. It is reported by the officials of the Great Northern and other roads using similar engines built by the Brooks Works that the most excellent results, both as regards speed and economy, have been obtained from these engines.

Indicator cards that have been taken both for freight and passenger service, all show a most excellent steam distribution for locomotive practice. The water used per indicated horse power per hour, as noted in log of tests, is 24 lbs. for passenger service and 22.4 lbs. for freight service. Both of these figures are remarkably low and go to show that the cylinder proportions and steam distribution effected by the use of the piston valve and valve motion pertaining thereto are remarkably perfect.

The boilers are of the Player patent improved Belpaire type, with conical connection wagon top, the outside diameter of the first course being 70 ins. and the working pressure 210 lbs. per sq. in., the pop valves being set at 212, 213 and 214 lbs. respectively. The total heating surface is 2677 sq. ft., 225 sq. ft. being in the fire box and 2452 sq. ft. in the flues. The grate area is 35.4 sq. ft. There are 303 2 1/4 in. O. D. flues. The fire box is on top of the frames, being 123 ins. long by 41 1/4 ins. wide inside the sheets, the depth of fire box being 80 ins. front and 62 ins. back, which is considerably more than usually applied to engines with fire boxes on the top of frames. It will be noticed

that the water spaces surrounding the fire box are unusually large, thus giving excellent circulation and increased length of stay-bolts, especially at the top; thus securing greater immunity from breakage thereof.

It will be noted that the horizontal seams of the boilers are sextuple riveted, lap, this being the Brooks Works standard practice, which they consider affords a lighter and more flexible seam than the butt-vertical. Some of the vertical seams are double riveted and others, that are subjected to more strain, are triple riveted. The fire box flue sheet is 5/8 ins. thick, the front flue sheet 3/4 in.

The smoke box is fitted with the improved form of Bell spark arrester, which has been applied to a great number of recent large locomotives built by the Brooks Works, and is giving most excellent results both with regard to freedom of steaming and freedom from sparks, thus fulfilling the requirements of an ideal spark arrester. This front end arrangement, as applied by the Brooks Works on some Great Northern engines, is illustrated in our issue of March, 1898, page 37.

The driving wheel centers, driving boxes, spring saddles, cross-heads, cylinder heads, piston, expansion pad brackets, engine draw casting or foot plate, and some other smaller details are all of open hearth cast steel.

The driver brakes are arranged in accordance with the Brooks Works standard practice with the brake shoes upon the back of the wheels and the

cylinders inside the frames, just ahead of the rocker boxes. The injector check valves are of the Brooks Duplex type, placed on top of the wagon top inside the cab with internal discharge pipe, thus making an easier arrangement of piping and dispensing with unsightly and straggling pipes.

The tender has a capacity of 4,500 gallons of water and 8 tons of coal and weighs with maximum load, about 96,000 lbs.

The principal dimensions of this engine are given in the appended table.

Type	.....10-wheel Passenger.
How many and dates of delivery	.....Eight—June, 1898
Gauge	.....4 ft. 8 1/2 in.
Kind of fuel to be used	.....Bituminous Coal
Weight on drivers	.....129,500 lbs.
Weight on trucks	.....36,500 lbs.
Weight, total	.....166,000 lbs.
Weight, tender loaded	.....96,000 lbs.

GENERAL DIMENSIONS.

Wheel base, total of engine	.....25 ft. 4 in.
Wheel base, driving	.....14 ft. 6 in.
Wheel base, total, engine and tender	.....53 ft. 7 1/2 in.
Length over all, engine	.....40 ft. 1 1/2 in.
Length over all, total, engine and tender	.....62 ft. 2 3/4 in.
Height, center of boiler above rails	.....8 ft. 9 3/4 in.
Height of stack above rails	.....14 ft. 11 1/4 in.
Heating surface, fire-box and arch pipes	.....225 sq. ft.
Heating surface, tubes	.....2452 sq. ft.
Heating surface, total	.....2677 sq. ft.
Grate area	.....35.4 sq. ft.

WHEELS AND JOURNALS.

Drivers, No.	.....Six
Drivers, diameter	.....63 in.
Drivers, material of centers	.....Cast steel
Trucks Wheels, diameter	.....30 in.
Journals, driving axle, main	.....9 in. x 11 in.
Journals, driving axles, front and back	.....9 in. x 11 in.
Journals, truck	.....5 1/2 in. x 12 in.
Main Crank Pin, size	.....6 1/4 in. x 6 in.

CYLINDERS.

Cylinders, diameter	.....20 in.
Piston, stroke	.....30 in.
Piston Rod, diameter	.....4 in.
Kind of piston rod packing	.....Jerome
Main rod, length center to center	.....120 1/2 in.
Steam ports, length	.....18 in.
Steam ports, width	.....2 in.
Exhaust ports, length	.....56 in.
Exhaust ports, least area	.....66.5 sq. in.
Bridge, width	.....2 1/2 in.

VALVES.

Valves, kind of	.....Improved Piston
Valves, greatest travel	.....7 in.
Valves, steam lap (inside)	.....1 1/8 in.
Valves, exhaust lap or clearance (outside)	.....1/8 in.
Lead in full gear	.....1-16 in. negative
Lead constant or variable	.....Variable

BOILER.

Boiler, type of	.....Player Improved Belpaire
Boiler, working steam pressure	.....210 lbs.
Boiler, material in barrel	.....Steel
Boiler, thickness of material in barrel	.....11-16 in.
Boiler, thickness of tube sheet	.....3/4 in.
Boiler, diameter of barrel	.....70 in.
Seams, kind of horizontal	.....Sextuple
Seams, kind of circumferential	.....Double and triple
Crown Sheet, stayed with	.....Direct Stays
Dome, diameter	.....30 in.

FIRE-BOX.

Fire-Box, type	.....Long, Sloping
Fire-Box, length	.....123 in.
Fire-Box, width	.....41 1/4 in.
Fire-Box, depth front	.....80 in.
Fire-Box, depth back	.....62 in.
Fire-Box, material	.....Steel
Fire-Box, thickness of sheets	.....Crown 3/8 in., Tube 5/8 in., Side and Back 3/4 in.
Fire-Box, brick arch	.....On water tubes
Fire-Box, mud ring, width	.....Back 3 1/2 in., Sides 3 1/2 in., Front 4 in.
Fire-Box, water space at top	.....Back 4 1/2 in., Sides 6 in., Front 4 in.
Grates, kind of	.....Cast Iron Rocking
Tubes, number of	.....303
Tubes, material	.....Charcoal Iron
Tubes, outside diameter	.....2 1/4 in.
Tubes, thickness	.....No. 11 B. W. G.
Tubes, length over tube sheets	.....13 ft. 10 1/4 in.

SMOKE-BOX.

Smoke-Box, diameter outside	.....72 3/4 in.
Smoke-Box, length from fire sheet	.....64 in.

OTHER PARTS.

Exhaust Nozzle, single or double	.....Single
Exhaust Nozzle, variable or permanent	.....Permanent
Exhaust Nozzle, diameters	.....5 in., 5 3-16 in., 5 3/8 in.
Exhaust Nozzle, distance of tip below center of boiler	.....1 in.
Netting, wire or plate	.....Wire

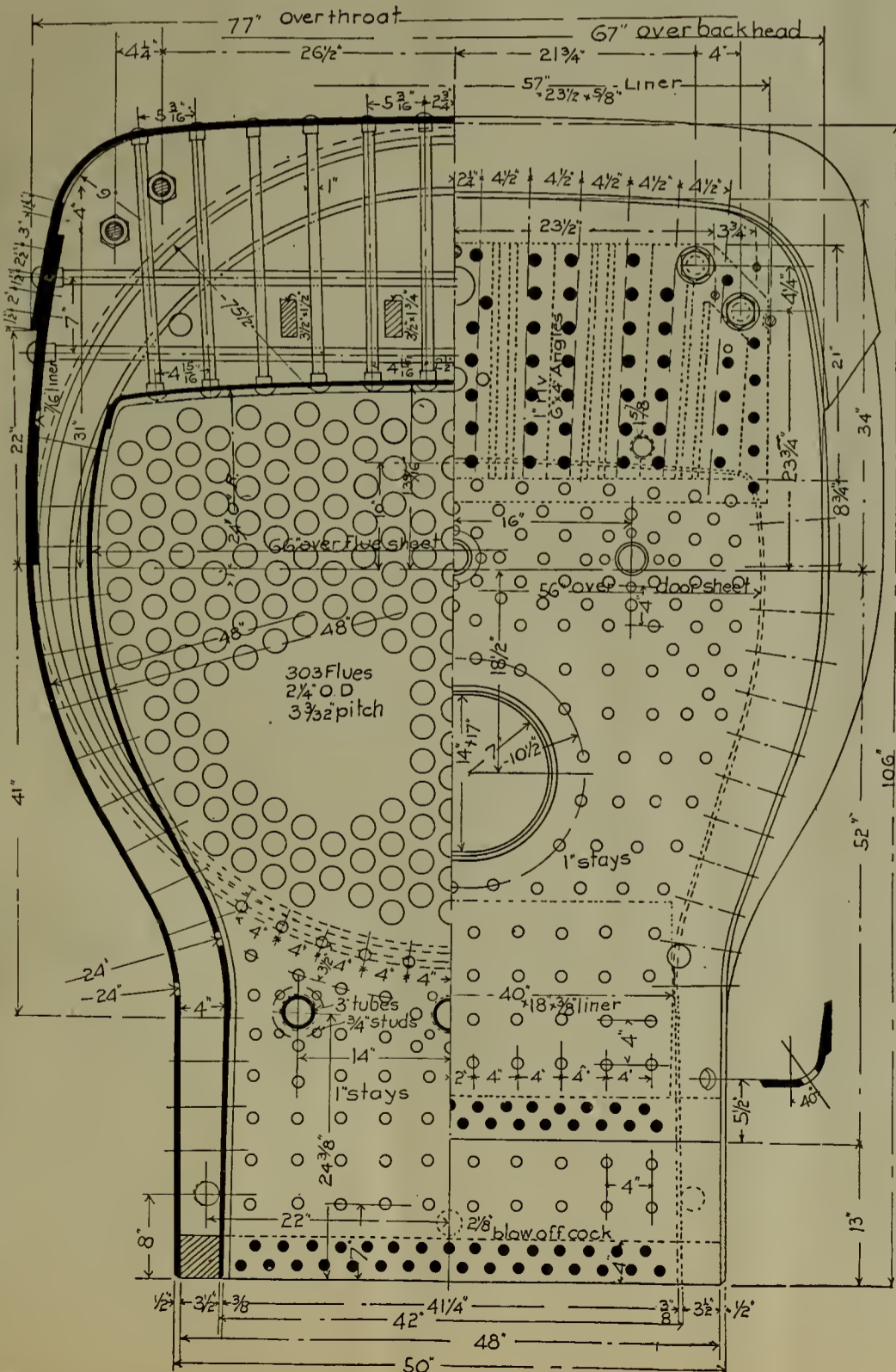

TEN WHEEL PASSENGER LOCOMOTIVE—GREAT NORTHERN RAILWAY.—THE BOILER.

Netting, size of mesh or perforation.....  
 .....2½ x 2½ and 2¼ x 1¼  
 Stack, straight or taper.....Steel Taper  
 Stack, least diameter.....157/8 in.  
 Stack, greatest diameter.....187/8 in.  
 Stack, high above smoke box.....38 in.

TENDER.

Type.....8-wheel, Steel Frame  
 Tank, type....."U" Shape  
 Tank, capacity for water.....4,500 gal.  
 Tank, capacity for coal.....8 tons  
 Tank, material.....Steel  
 Tank, thickness of sheets.....3-16 in. and ¼ in.  
 Type of under frame.....Steel Channel  
 Type of springs.....½ Elliptic  
 Diameter of Wheels.....33 in.  
 Diameter and length of journals.....4¼ in. x 8 in.  
 Distance between centers of journals.....4 ft. 10 in.  
 Diameter of wheel fit on axle.....53/8 in.  
 Diameter of center of axle.....4¾ in.  
 Length of tender over bumper beams.....21 ft. 4 in.  
 Length of tank.....19 ft. 6 in.  
 Width of tank.....8 ft. 8 in.  
 Height of tank, not including collar.....55 in.  
 Type of draw gear.....M. C. B. Standard

SPECIAL EQUIPMENT.

Brakes.....  
 N. Y. Automatic for drivers, tender and train service  
 Pump.....No. 2  
 Sight Feed Lubricators.....Nathan  
 Safety Valves.....Crosby  
 Injectors.....New Nathan No. 10 and Monitor No. 10  
 Springs.....French  
 Metallic Packing.....Jerome

GENERAL LOG OF RESULTS

LOCOMOTIVE TESTS ON THE GREAT NORTHERN RY.  
 BETWEEN CLANCY AND WOODVILLE.

	Pass.	Freight
Engine No.....	154	154
Date of trial.....	7-28-98	7-29-
Length of run, miles.....	48.1	48.1
Kind of service, freight or passenger.....	P	F
Weather.....	Fine	Fine
Condition of rail.....	Good	Good
Time on the road.....	2h. 17 m	4h. 35 m
Actual time in motion.....	1h. 50 m	3h. 34 m
Maximum speed, mile per hour.....	49.5	33.8
Average speed, miles per hour.....	26.2	13.5
Maximum revolutions per minute.....	264	170
Maximum piston speed, feet per minute.....	1320	900
Maximum boiler pressure.....	210	210
Minimum.....	185	165
Average.....	196.4	198
Prevailing cut-off, inches.....	7" & 10"	7.10, 18"
" " per cent. stroke.....	23 & 33	23, 33, 40
Wt. train in tons 2000 lbs. incl. of loco. & tender.....	289	549
Wt. of train excl. of loco. and tender—tons.....	157	417
No. of cars, loaded.....	5	11
Total weight of coal consumed—lbs.....	7300	11600
No. of miles per ton of coal.....	13.2	8.3
Pounds of coal used per mile.....	152	241
Coal used per 100 tons of train per mile.....	52.7	44.0
" " back of tender, per mile.....	16.8	57.9
Av. wt. coal burned per sq. ft. of grate, pr. hr.....	127 lb.	101 lb.
Temperature of feed water.....	56°	56°
Water used per mile, lbs.....	724 lb.	1235 lb.
" " 100 tons of train per mile.....	251 lb.	225 lb.
" " beh. tend., mi.....	461 lb.	296 lb.
" " sq. ft. or heating surf. per hr.....	8.28 lb.	7.01 lb.
" " grate surf. per hour.....	626 lb.	529 lb.
Actual evaporation per lb. of coal.....	4.93 lb.	5.27 lb.
Equivalent evap. from and at 212° per lb. coal.....	6.00 lb.	6.40 lb.
Max. I. H. P. developed.....	1468	1116
Ave. ".....	922	839
Coal per I. H. P. lbs.....	4.87	4.26
Water.....	24	22.4
Av. No. of sq. ft. of heating surface per I. H. P.....	2.9	3.19
Av. No. of I. H. P. per sq. ft. of grate surf.....	26.1	236
Max. grade, feet per mile.....	116	116
Average rise, feet per mile.....	64.7	64.7

PILE DRIVER CAR L. S. & M. S. RY.

In our last issue we illustrated very fully, by photographic views, the remarkable pile driver car that the Lake Shore & Michigan Southern some time ago placed in service. It will be remembered that the engineering department had quite a problem to meet in designing this machine, and we will briefly restate this problem:

It was necessary to design a machine which,

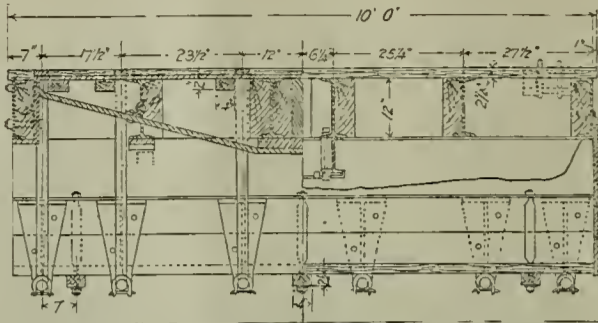

PILE DRIVER CAR—L. S. & M. S. RY.

while a good, serviceable pile driver, must be a car when ready to travel on the road, and be capable of being coupled as such into any regular train and take its chances along with any other equipment. While it would be used principally on renewal work, and at such would work to better advantage with the leads close to the car, it must be capable of an extension for new work, washouts, etc. (it was given an extension of 16 ft.), and also a side scope for work outside of the tracks (it was given a side scope of 30 ft.). Moreover, as much of its work was to be done at a distance from a dodging track, and as it is necessary to use all available time on busy tracks, and as wires and other overhead obstructions are very often found between its working place and dodging track, it must be able to raise and lower its leads within itself, and in the very quickest possible manner. Another feature to be met was, that as the engineers' department is independent of the operating department, and consequently always using more of their power than they can spare, the pile driver must have a self-propelling power that will constitute it a locomotive, capable of handling not only itself but to a very considerable degree its equipment of boarding cars and several cars of material, so that it will not ordinarily need a locomotive. (It was made capable of moving itself at 20 miles an hour with a train of two boarding cars and two to five or more cars of material, according to grade of track.)

If the engineering department had an interesting problem, as above indicated, the car building department had one also, in building a car to carry the machinery of this pile driver. The leading feature of this problem was to design a car body that was to be called upon to carry a load of some 50,000 lbs. within a radius of about 5 ft. near the center of the car.

Through the courtesy of General Master Car

Builder A. M. Waitt, we are enabled to give detail drawings of the car proper. Our engravings show in such complete detail the manner in which the problem was met that but little in the way of descriptive notes is required. It will be seen that 12-inch channels were used for side and end sills, and 12-inch I-beams for center sills, accompanied by 4x12 wooden sills which on the sides and intermediates are fitted in on one side of the I-beams and on the two centers are fitted in on both sides of the I-beams, excepting at the ends, where the inside wooden pieces are omitted up to the first cross member. This liberal use of metal and of generous dimensions is supplemented by the employment of six 2-inch truss rods which are trussed to a depth of 29 inches. The four outside truss rods are carried through to the end sills and the two center rods are formed over and lipped into and bolted to the center sills in the manner shown. Very substantial draft gear completes a remarkably neat and strong job of construction. The car has been in active service for some considerable time and has been standing up to its work admirably; and no sag has been developed under the extraordinary strain to which it is subjected.

The Master Car Painters.

The Master Car and Locomotive Painters' Association met in St. Paul Sept. 13. Excellent work was done on the lines announced in our August issue. The following officers were elected: President, H. G. McMasters; first vice-president, D. A. Little; second vice-president, A. J. Bruning; secretary and treasurer, Robert McKeon. The association will meet next year in Philadelphia.

The "Proceedings" of the Master Car Builders and of the Master Mechanics Associations have both been issued by Secretary John W. Cloud. The latter has done very creditable work in getting out these proceedings so promptly and in such tasteful typographical form. Both publications are carefully indexed, with all needed fullness of references, and thus the notably valuable technical information contained within their covers is placed at ready command of the investigator and student.

The Baltimore & Ohio has made a notable record in the way of acquiring new and thoroughly modern equipment. Within the past 60 days the receivers have ordered almost 6000 new freight cars of which the Pullman Company is building 1000 box and 1000 drop-end gondolas; the Michigan Peninsular 3000 box cars, and the South Baltimore Car Works 200 box cars, 500 hopper coal cars and 15 four-wheel cabooses—making a total of 22,735 freight cars ordered in less than two years. These cars are all of modern construction, are fully equipped with air brakes and automatic couplers, and average 60,000 pounds capacity. It is estimated that fully 85 per cent of the B. & O. freight cars have air brakes and automatic couplers in accordance with the interstate commerce law.

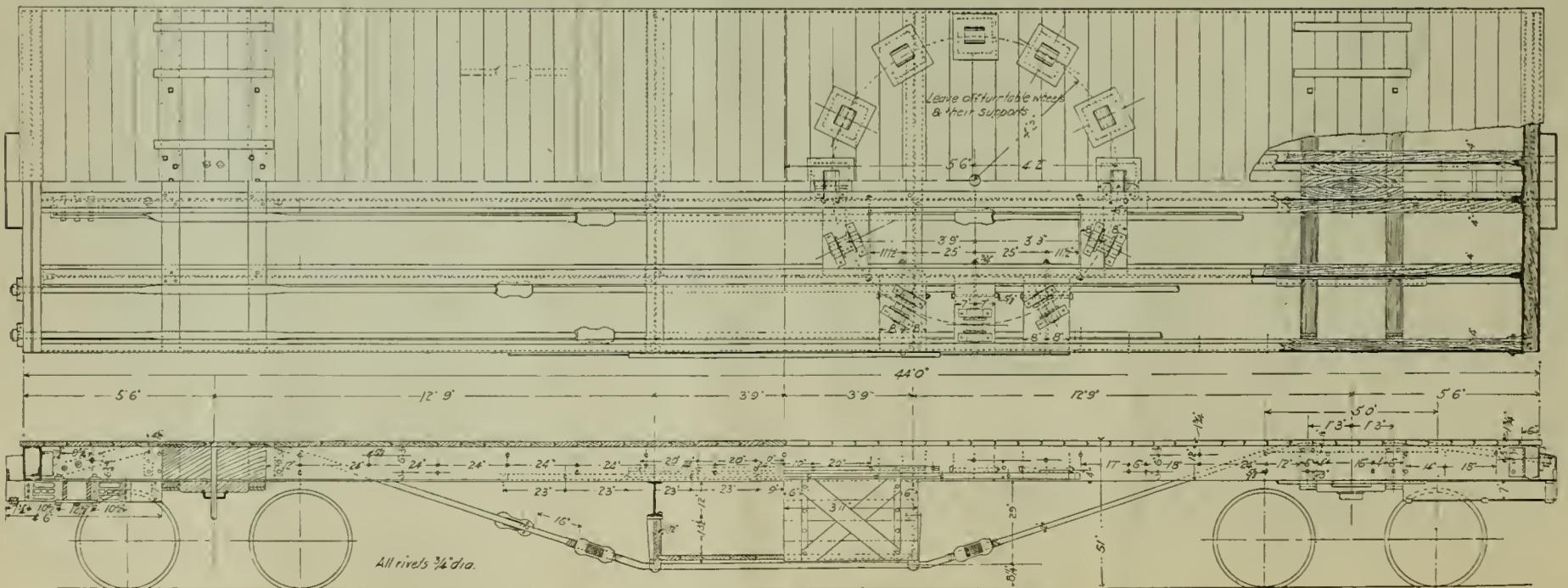

PILE DRIVER CAR—LAKE SHORE & MICHIGAN SOUTHERN RAILWAY.

**THE DE WALLACE TRAIN ORDER SIGNAL.**

In the De Wallace train order signal, invented by Mr. Harry De Wallace, of St. Paul, Minn., the object sought for (the attainment of which has been fully demonstrated by experiments and trials on railways of the Northwest) has been to provide an accurate and reliable distance indicator and reminder signal, for use by locomotive engineers, for the purpose of preventing forgetfulness, and the miscarriage of train orders and other obligations, and further, to automatically apply the air and stop the train a safe distance short of the order point, in case the engineer fails or neglects to release the same within a given time.

To solve this problem, Mr. Wallace has devised his purely mechanical train order signal and stopping attachment, which works automatically, is positive in its connections and action, reliable and effective in all its work, and can be supplied and maintained at a moderate cost and expense.

In operation, the device, shown in the accompanying illustration, is placed in the cab, within easy reach and in plain view of the engineer, so that he can observe, set and release it conveniently. It is positively connected with the running parts of the locomotive, whence it derives its power and motion. The preferred connection is made with one of the forward truck wheels or axle, by means of a spiral belt and "V" groove pulleys, although connections may be made at other points and by other positive means.

The revolutions of the wheels give the distance indicated by the pointer on the dials, which shows and measures the travel of the engine or train in miles, with absolute accuracy, whether running forward or backward, and without change or attention. So that by looking at the face of the machine the engineer can tell at any time the exact distance he has run from starting point, and incidentally he is informed at all times as to just where he is at, no matter whether it is light or dark, stormy or foggy.

When orders are received for meeting or passing of other trains, or orders for any other purpose, which require attention or execution at a distance ahead, the engineer, or the conductor and engineer together, set the signal by pulling out one of the triggers or dogs shown on the upper dial and hooking it over the notched edge at the graduation or notch corresponding to the mileage number which appears opposite the name of the station on the schedule card attached to the machine at the right. If he has more than one order, then several of the triggers are used in the same manner, at the same time. The illustration shows settings for four supposed orders: One at twenty-seven miles for Anoka; a second at fifty-six miles for Becker; a third at seventy-five miles for St. Cloud, and a fourth at ninety-one miles for Avon. There are still eleven idle triggers left that may be used for intermediate settings, in case they should be desired or required.

In this way, under the present construction of the device, as shown, it will take care of fifteen distinct orders or settings at as many different points. These settings then remain in their respective positions until the hand, which rotates between the two dials, reaches each of the triggers in the order of their setting, and in passing beneath them trips them off, when, the next instant the signal, which is a small whistle, blown by air pressure, begins to sound. The whistle continues to blow during the time it takes the train to run over the first quarter of a mile from the point where the setting is released. If the whistle is not silenced by the engineer within that distance, then the device automatically releases the air from the train pipe and stops the train, independently of the engineer's action or assistance. In other words, it takes the control of the engine and train away from the engineer for the purpose of stopping the same, in case he fails, for any reason, to release the signal before the brakes are set.

The engineer, to release it, should pull out the button "A," which projects beyond the center of the dials, and thus retain control of his train. By pulling this button, the further action and opening of the valve will cease. To quiet the whistle, he should thrust in with the finger the button "B" at the lower right hand corner of the case. This slight act will cause the valve to instantly close and prevent the setting of the brakes. At each setting the signal and other automatic acts of the device will

be repeated, without further attention, except the releasing by the engineer just referred to.

An engine may engage in switching for indefinite periods of time and distances, and no attention or change is required. But if the shift button "D" is pulled out, the engine or train may back up for long distances, and the hand or pointer will be kept going ahead, indicating the miles to correspond with the numbers on the card, and thus enable the engineer to set the same for orders with the same facility when backing up as when going ahead. For ordinary switching this button is not used and the machine will take care of itself. The shift is used merely to save the engineer the necessity of figuring out the backward mileage for setting purposes, as then he can use the card mileage instead.

In starting out on a run the hand should be set as shown in the cut. It should also be set at the same point when the return run is begun. It may be set at any point shown on the dial if desired.

The schedule card bears the names of the stations, sidings, railroad crossings and any other points that may be required for signal purposes. The device may be set for signal on any mile not shown on the cards, there being no disputed or

the signal is not released, the brakes will be set and the trains stopped before they can possibly come together. If they are thus reminded of their orders and duty, then they will not forget them again in so short a distance. Settings may be made for crossings, slow bridges and the like, and the effect and results be the same. If an engineer has difficulty in finding a place in the night, or storm, or fog, he can set the device, and it will locate it exactly and let him know about it. This instrument will stand a speed of 150 or more miles per hour and do good work.

The shaft marked "C," at the lower left corner of the case, is extended and connected with the belt and pulleys attached to the truck axle, and is driven by them. The movement of all the parts of the signal case is very slow, thus ensuring a long working and wearing life. The working parts are all automatically lubricated.

The signal is a small shrill whistle placed inside the case at the point marked "E" in the cut. It is blown by the air supplied by the brake valve. It can be adjusted to any pressure and its pitch varied as desired.

The pipe marked "I" connects the train pipe and

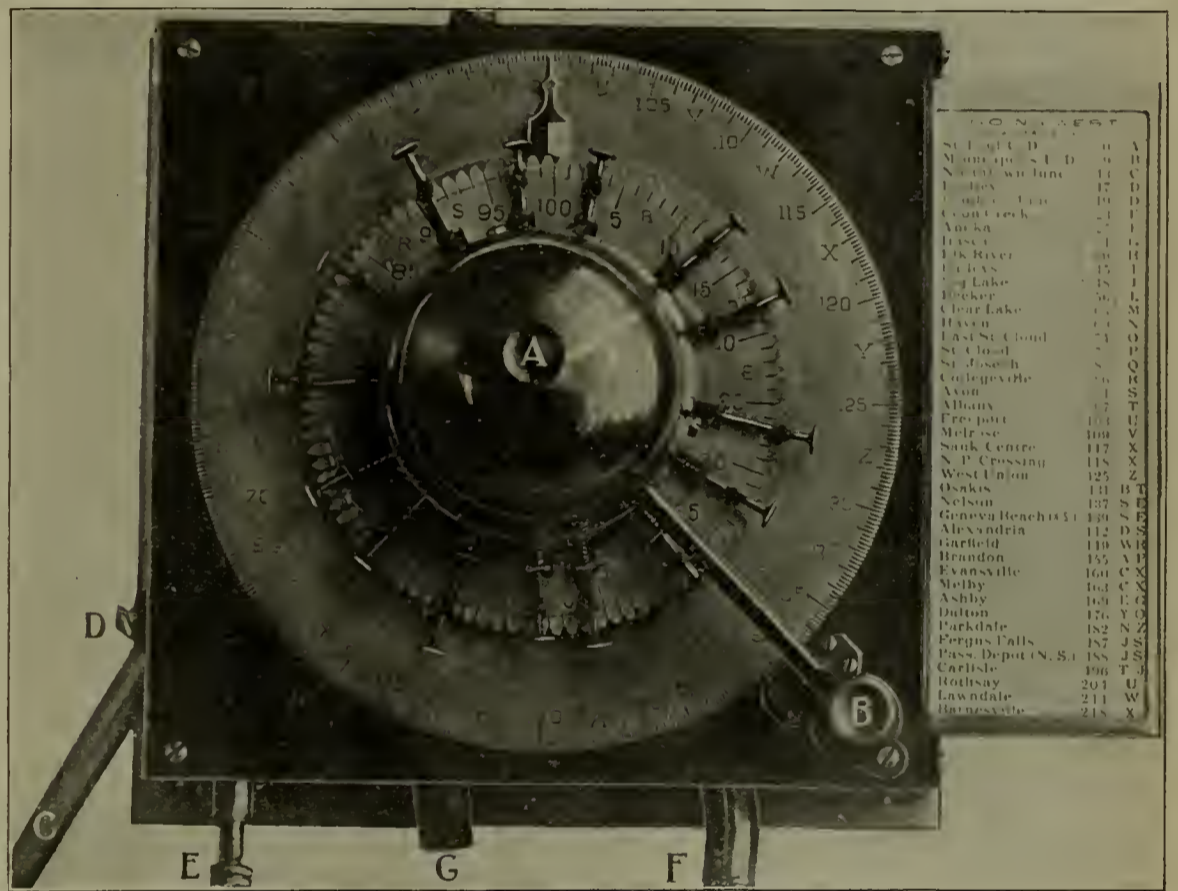

THE DE WALLACE TRAIN ORDER SIGNAL.

blank mile on the round of the dial. The mileage on the card begins at starting point with zero, and increases in even miles to the end of the run, the same as the hand shows the increased travel of the train. The other side of the card contains the stations and mileage in the reverse order. Each machine is to be equipped with separate cards for each of the different divisions or runs of a road, then when engines are changed from one run to another, only the cards require to be shifted in the holder to make ready for the new run. The card mileage to each station is from one to two miles less than the exact distance, owing to whether it is level or down grade approaching the points named. The figures of the card are used in setting for signal, and are intended to be at least one mile short of the near switch. This is done so that the signal will sound a mile from the point where the train may have to take the siding, and then the automatic stopping of the train, if that should be permitted, will occur before that switch is passed. The letters on the card are intended to be used by the dispatcher, and inserted after the station names in the orders, as a check, to prevent his giving the wrong station for a meeting point. If the check letter and the station name do not agree, then he has made a mistake and those receiving the order will detect it.

By using this device, two trains approaching a station in opposite directions will each be signalled from one to two miles short of the station, and if

the brake and signal valve of the device. The pipe "G" is where the air exhausts when released to set the brakes. When applying the air the machine makes a heavy service application, which may be varied as desired.

The inventor has added to the signal combination what he calls a "disorder signal." The purpose of this is to notify the engineer, in case the train order signal or its connections get out of order, or for any reason fail or cease to do their work. It will also give a warning when any of its own parts become disordered. This makes the invention entirely reliable. If the engineer should learn to rely implicitly upon this signal, and it should fail without his notice, this latter attachment will let him know it at once. If it signals "out of order," then for the remainder of his run he will not rely upon or use it again until repaired or replaced. Many prominent railway officials say that with this feature added, the device is absolutely reliable and free from objection.

Some time ago this invention was subjected to a very severe test upon the Great Northern railway for a period of six or seven weeks, covering a distance of over seven thousand miles. In this test it was attached to one of their large Brooks passenger locomotives in service pulling their coast train between St. Paul and Barnesville, Minn., the run being 220 miles each way and on fast time. Here it operated for one full month, and after that it operated on the same engine for a round trip

from St. Paul to Portland, Ore., a distance of nearly five thousand miles. This was done with the inventor's first complete machine, and the tests were said to be a clear demonstration of all his claims for the invention and its principles.

Very recently Mr. De Wallace made a further trial of his second machine (from which the accompanying cut was made) on the Sault Ste. Marie railway between Minneapolis, Minn., and Gladstone, Mich. The distance between these two points, 356 miles, was traversed several times. The locomotive (No. 500) to which it was connected, was one of their fine large Schenectady's, used in drawing their Atlantic and Pacific Limited. In this, as in the former tests, the device measured all distances with absolute accuracy at each degree of speed. It signalled at the exact point set for upon every occasion, and when permitted to do so, it set the brakes and stopped the engine or train immediately after the signal had sounded its measured time.

A NEW AXLE GAGE.

The axle gage shown in the accompanying engravings will at once command itself to all practical railway men. It was devised and has been successfully used by Mr. Thos. Fildes, Division Master Car Builder of the Lake Shore & Michigan

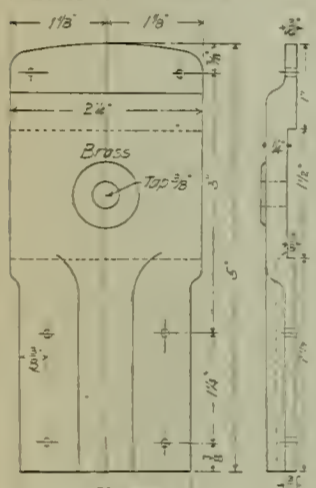

FIG. 2.—A NEW AXLE GAGE.

Southern Railroad at Chicago. It is so excellent in design and of such extreme utility in service that we give complete detail drawing of the device and of its parts. Fig. 1 shows a general plan of the device, the center portion being cut out, however, to enable us to present it in larger detail. It consists of a piece of oak 3 in. by 1 in. and 7 ft. 11 ins. long, tapered as shown. The two arms, which are set into this piece of oak and riveted thereto,

are made of pieces of No. 06 gage corrugated galvanized iron, riveted together as shown in the sectional view, and formed in the shop bulldozer to the outlines shown. One of these arms carries a piece of graduated steel, sliding in and out of a socket as shown. The slideway for this scale is provided by flattening the end of the arm and backing it with a brass plate, the detail of which is shown in Fig. 2, and which is riveted to the flattened portion of the arm.

The application of this gage over the wheels will

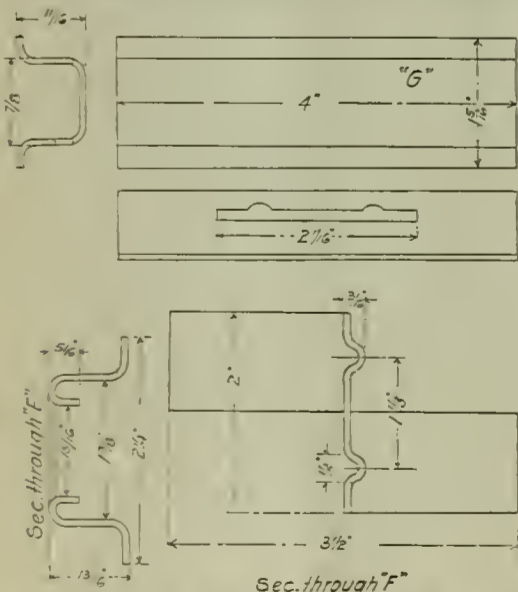

FIG. 3.—A NEW AXLE GAGE.

be readily understood. After the first design was made, it was found desirable to put on the attachments F, which make it unnecessary for a man to be at the other end of the gage. The operator merely drops the gage over the wheel and the attachments, F, seat themselves on the tread of the wheel. This brings the gage directly in line with the journals and supports it while the reading is being taken. It will be noted that these attachments are scaled and that they slide in their socket, which is riveted to the oak portion of the gage. They

are thus readily set for any size diameter wheel from 28 to 42 ins. The details of this attachment are shown in Fig. 3.

The gage is remarkably light, weighing only 14 lbs. complete, with attachments. The inspector works with these instructions: First, report the capacity of the car; second, the length and diameter of the journal; third, the thickness of the collar; and, last, the length over all of the axles, this being gained by reading the scale carried in the arm of the gage.

International Association for Testing Materials.

The first annual meeting of the American section of the association was held at the Engineers' Club, Philadelphia, on Saturday, Aug. 27. There were 26 members present. Prof. Mausfield Merriman called the meeting to order for the afternoon session. Dr. Richard Moldenke called attention to the fact that the testing of cast iron was not specialized on the list of problems, but was made quite co-ordinate with the general study of the testing of iron and steel. Accordingly Dr. Moldenke was requested to draw up a resolution on the subject for action at the evening session. There was considerable discussion relative to the merits of testing by impact, Prof. Hatt, Messrs. Webster, Kreuzpoitner, Riehle, and White giving various phases of the problems encountered. On motion of Mr. Henning, Prof. Hatt and Prof. Marbury, were appointed two members of a committee of three to investigate and report upon the present status of our knowledge on the subject of testing by impact.

The evening session was opened at 8, and Dr. Moldenke presented the following: "Resolved, that the council of the International Society for Testing Materials be requested to appoint a committee to investigate methods of testing cast iron." This was adopted unanimously. The subject for discussion was "The Relation of the International Association to Producers and Consumers." Mr. William R. Webster gave a very earnest plea for the lessening of the number of specifications now existing and brought out the difficulties attending business dealings between America and the old world. Thus our basic steel, which equals acid, owing to the comparatively pure materials used will not be accepted in Europe for bridges and structures because they have a prejudice against it based upon their own material made from inferior stock. The International Society could do much to correct this misapprehension on their part regarding the quality of our product and thus benefit the American trade. The next subject discussed was "In What Manner Will the Adoption of Standard Specifications Improve Industrial Methods and Processes?" Mr. Gus. Henning gave some interesting experiences with prominent industrial concerns of this country who are invading foreign markets.

The Master Blacksmiths' Association.

At the meeting of the National Railroad Master Blacksmiths' Association in Boston September 6, 7 and 9, the following subjects were taken up and discussed: Best and Most Economical Methods of Handling Scrap; Best Methods of Making and Repairing Locomotives and Car Springs; Best Meth-

ods of Producing Locomotive Forgings; Best Design for Heating Furnace; Best Methods of Making Car Axles; Machine Forgings in Locomotive and Car Construction; How to Obtain best Results in Making and Repairing Locomotive Frames; Making and Repairing Track Tools

Officers were elected as follows: W. W. McLellan, D. & R. G. R. R., Denver Col., president; G. F. Hinkens, St. P. & D. R. R., St. Paul, Minn., first vice-president; G. A. Geuthner, B. & M. Ry., Boston, Mass., second vice-president; A. L. Woodworth, C. H. & D. Ry., Lima, O., secretary and treasurer; R. A. Mould, Erie Ry., Galliou, O., chairman executive committee.

A SUBSTITUTE KNUCKLE FOR M. C. B. COUPLERS.

A decided novelty in the way of coupler attachments has been devised by Mr. H. H. Warner, Division Master Mechanic of the Northern Pacific at Tacoma, Wash. It is a substitute knuckle to be used in case of knuckle breakage, and its form and method of application are clearly shown in our engravings.

In the operation of freight trains of the materially increased size and weight employed in approved standard practice delays are frequently occasioned in transit by damage to or breakage of the knuckles of car-couplers of the Master Car Builders' type, which delays may to a large extent be avoided or reduced by the provision of a suitable temporary substitute for the broken knuckle which can be promptly fitted to its place. Of course, by reason of the great variety of forms of knuckles now in use, such substitute must be practically universal in application to the various constructions of couplers which are now in use and must be applicable without any substantial degree of labor or loss of time—and Mr. Warner's device meets these requirements

In present practice it is usual in the event of the breakage of a knuckle to remove it and connect the coupler-head which carried it with the adjacent coupler-head by a link and pin. There are several objections to this practice, among which may be noted the liability of bending the knuckle-pin of the disabled coupler, owing to the space between the lugs which hold it and to the fact that the knuckle-pin is usually inadequate to sustain the draft strain and in bending often damages or breaks the lugs. Again, the increased distance between couplers so connected creates considerable lost motion, and severe shocks to the draft attachment result by which they are frequently damaged. In case of breakage of the coupler-lugs, or if a link and pin is not available, the couplers are chained together, which operation delays the train and often has to be repeated before a terminal or repair station is

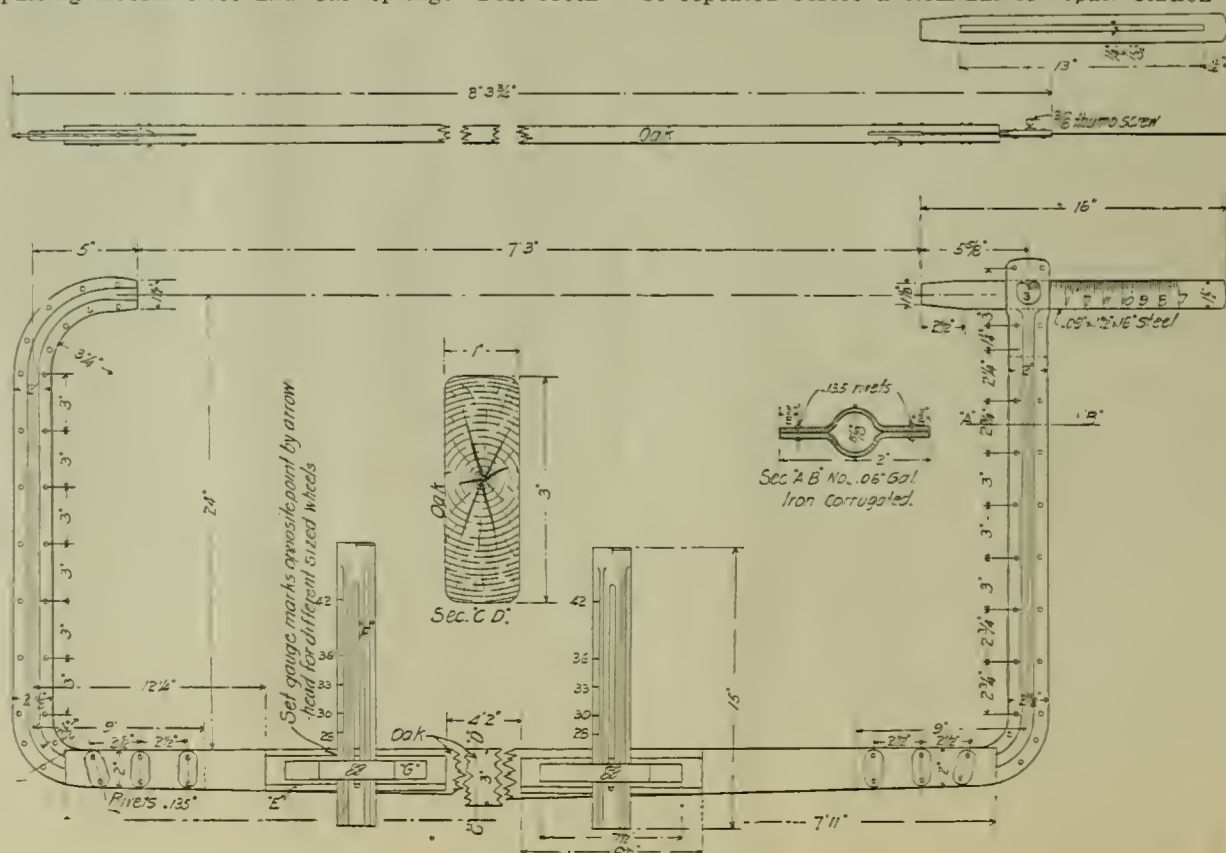

FIG. 1.—A NEW AXLE GAGE.

reached. To avoid these objections, the caboose or tool cars of trains are often supplied with a spare knuckle of each of the various kinds in ordinary use. Each of these has its own special design of tail-locking mechanism, which necessitates keeping and carrying an inconveniently large stock of knuckles in each caboose-car, and also that the train crews be educated in the removal and replacement of knuckles on the road and be provided with the necessary tools for this work. Some of the knuckle attachments are difficult to change even by those having a fair knowledge of proper meth-

**Axle Light on the Santa Fe.**

The National Electric Car Lighting Company, which is introducing the Axle Electric light, has made a contract with the Pullman Company for the lighting of all the Pullman cars which run on the Santa Fe Limited between Chicago and Los Angeles, without change, a distance of 2265 miles. There are four trains in this service, each of which has an observation compartment car, three sleeping cars and a handsome dining and library car; the two last-named being already equipped with Axle

plant in the baggage car. The objection to this latter plan is that if the baggage car meets with an accident, or the plant is out of order, the entire light output of the train is deranged. In the axle light system such a thing cannot happen. Each car has its own plant, which is small but compact and complete, consisting of dynamo and storage batteries, and actual measurements made on the cars already equipped demonstrate that after the round trip to Los Angeles of over 4500 miles and supplying the cars during six nights with brilliant light, the storage is as full as it was at the start. In case of an accident to the apparatus of one car, the crippled car can be lighted from an adjoining car until a terminal is reached, where repairs can be made.

**PNEUMATIC HOIST FOR LOADING WHEELS.**

There are shown here illustrations of a pneumatic hoist for loading mounted car wheels, which is in use in the car department of the Chicago & Northwestern Railway in Chicago. The device is so simple that only a short description of it is necessary. An eleven-inch cylinder is placed beneath the rail (and midway between them) of the loading track; the piston rod is an old 7-inch steam pipe and when the piston is at the lowest point of stroke the upper end of the piston rod scarcely extends as high as the base of rail. This allows the hoist to be covered when not in use without placing any obstruction above ground. When the hoist is in use an extension is placed on the end of the piston rod and the

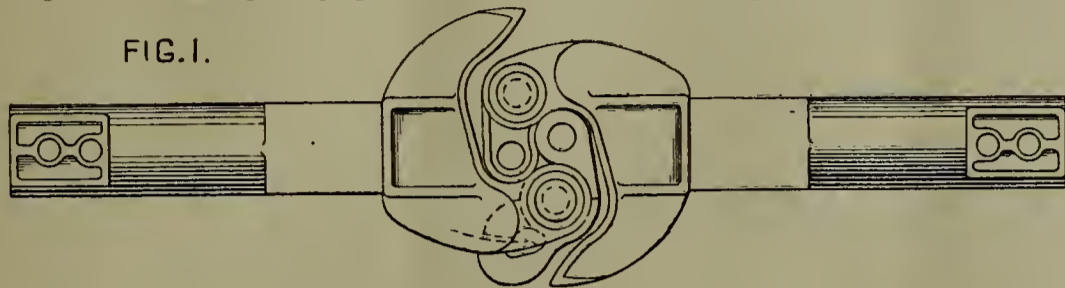
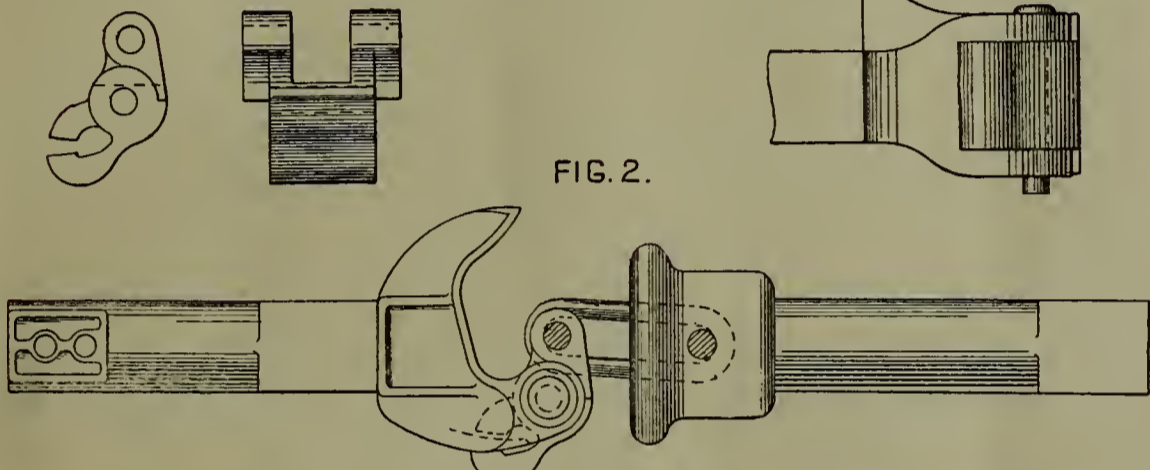

FIG. 4.

FIG. 5.

FIG. 3.

FIG. 2.



**A SUBSTITUTE KNUCKLE FOR M. C. B. COUPLERS.**

ods, and delays to trains necessarily result. Even where a fairly large stock of knuckles is kept in the caboose it will often happen that the proper one is not among them, and in order to avoid the use of a link pin or the chaining up of the couplers the train hands will remove a knuckle from a car which may be at hand on a siding. This operation involves delay in itself and additional delay and difficulty to those who must handle the standing car from which the knuckle has been taken.

The objectionable features of train service above indicated are effectually avoided by the employment of the substitute knuckle, which we illustrate and which is readily insertible by ordinary train hands without special tools, and by means of which the car having the disabled coupler can be safely and properly hauled to a point where proper knuckles and repairers are available to restore it to normal condition, or to be taken to the terminal station, if desired. This substitute knuckle is made adaptable to all car-couplers of the Master Car Builders' type and is capable of engaging automatically with the knuckles of such couplers on their proper contour lines of draft when substituted for a broken or disabled knuckle. It may also be used in connection with the ordinary coupling by the employment of a link and pin, as shown in Fig. 2. Its application is effected without removing any parts other than the broken knuckle when it replaces, and when this is done upon the road in transit no special tools are required.

The substitute knuckles are made of steel or wrought-iron, and several of them can be conveniently carried in the caboose or way-car of a train ready for use in emergencies. They can be readily and quickly applied, and will enable the comparatively large stock of extra knuckles ordinarily carried to be dispensed with, as well as avoid trouble and delay in application, which is commonly experienced in present practice. The knuckle has been patented by Mr. Warner, and is, for the present represented by Mr. Geo. W. Cushing, 308 Western Union Bldg., Chicago.

light and fans. The electric equipment of each train will aggregate 4928 candle power, as follows:

1 observation compartment car.....	1056 C. P.
3 sleeping cars at 1056 C. P. each.....	3168 C. P.
1 dining car .....	352 C. P.
1 library car .....	352 C. P.

Total ..... 4928 C. P.

All berths will be provided with berth lights, and this will be the first train in the world carrying such a large supply of light service exclusively from the car axles. In fact, it is the intention to light the locomotive headlight from the same service, thus making these four trains solid axle-light trains throughout.

The dining and library cars, together with about 60 other cars of the Santa Fe, have been in service with this light for nearly two years, and the results have been so satisfactory to the railroad company that an extensive application of this light has recently been decided upon.

The introduction of this system on the palatial limited trains will mark quite a departure from previous practice, which necessitated a large light



**PNEUMATIC WHEEL HOIST—C. & N. W. RY.** cap at the top with two grooves for the axle, at right angles to each other (see Fig. 1), reaches nearly to the height of the axle. The hoist raises the wheels and axle above the trestle, the axle being parallel with the rails, during the process of hoisting, then the axle and wheels are given a quarter turn on the hoist and are delivered to the trestle which carries them to the car. This device is giving such satisfaction at the Chicago shops that Mr. C. A. Schroyer, superintendent of the car department, to whom we are indebted for our photographs, is having several others built for outside points.

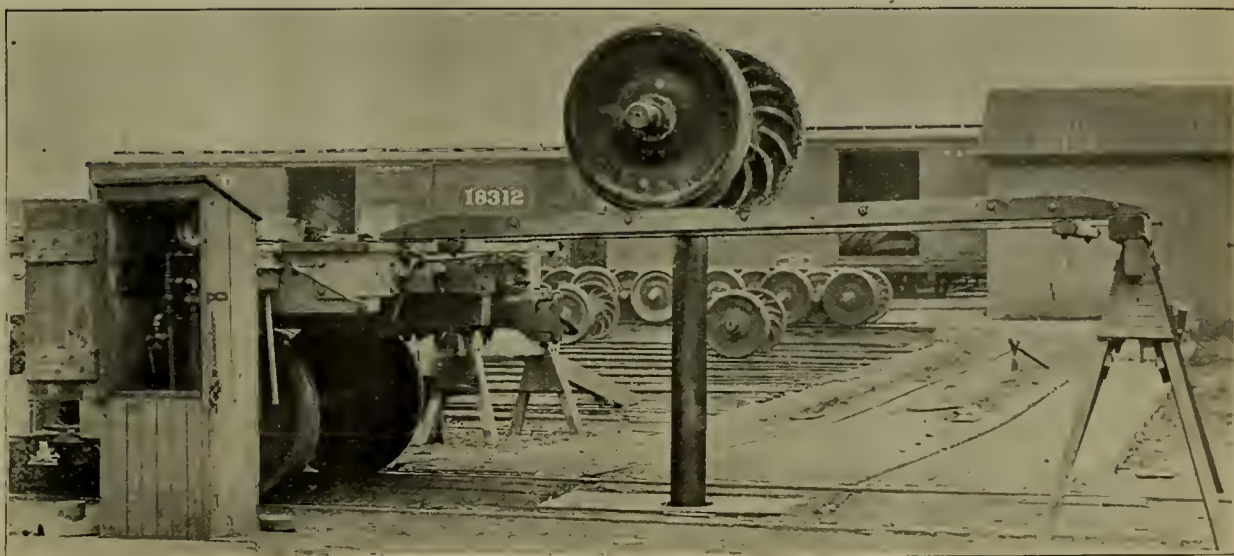

**PNEUMATIC WHEEL HOIST—CHICAGO & NORTHWESTERN RAILWAY.**

### The Traveling Engineers.

The Traveling Engineers' Association met in Buffalo, in September. A very profitable meeting was held, a good range of important subjects being quite fully treated not only in committee report but in discussion. We hope to cover some of the features of the work in a later issue. Officers were elected as follows: President, D. R. McBain; first vice-president, P. H. Stack; second vice-president, Charles Davies; third vice-president, C. P. Case; secretary, W. O. Thompson; treasurer, C. A. Crane. The association will meet next year in Cincinnati.

### CAR FOREMAN'S ASSOCIATION OF CHICAGO.

#### SEPTEMBER MEETING.

The Car Foremen's Association of Chicago held its regular monthly meeting at the Great Northern Hotel, Chicago, on the evening of September 8, President T. B. Hunt in the chair. Among those present were the following:

Blohm, Theodore.	Kennicott, Geo.
Buker, J. E.	Kroff, F. C.
Burnett, R. W.	Kramer, Wm.
Bohan, W. J.	Manthey, H. H.
Cook, W. C.	Mileham, C. M.
Callahan, J. P.	Miller, M. M.
Cervin, John.	Morris, T. R.
Davies, W. O., Jr.	Mattes, J.
Deen, Chas.	Murray, D.
Groober, Geo.	Nelson, John.
Guthenberg, O.	Olsen, Louis.
Guthenberg, Bruno.	Reinhard, F. B.
Grieb, J. C.	Sharp, W. E.
Gehrke, Wm.	Spies, W. F.
Goehrs, Wm. H.	Stuckie, E. J.
Holtz, Chas.	Smith, E. B.
Holtz, Chris.	Shannon, S.
Hagen, C.	Stagg, C.
Jones, R. R.	Stocks, J.
Johnson, Gus.	Schoenberg, C.
Johannes, Albert.	Shutt, Frank.
Krump, M.	Silvus, W.
Kemp, J.	Upton, S.
Kamen, Fred.	Williams, T.
Kuhlman, H. V.	Wensley, W. H.
Kirby, T. B.	

President Hunt: As the minutes of the previous meeting were printed in the Railway Master Mechanic, there will be no necessity for reading them and they will stand approved if there be no objections.

Secretary Sharp: The following have made application for membership and have been approved by the executive committee:

#### New Members.

A. E. Manchester, W. C. Cook and Louis Olsen, of the C., M. & St. P. Ry.; Geo. Ford, of the N. Y., C. & St. L., and W. F. Spies, of the B. & O.

#### Program for Annual Meeting.

W. H. Wensley, chairman of the committee appointed to arrange a program for the annual meeting, reported that correspondence had been had with officials of the Belt Line concerning an excursion over that line.

Secretary Sharp stated that, following the committee's wish, he had been informed by the superintendent of the Belt Line Railway that they would furnish a train on any Monday in October. This day was chosen on account of its being a light business day. A sufficient number of cars would be provided to take all who might care to go. The Belt Line would take the members to the several interchange points on that line, and include a visit to the South Chicago Steel Works.

The report was accepted and the committee was continued. Secretary Sharp was made chairman of the committee and Geo. F. Wentzel was added to its membership.

A communication from Mr. S. J. Kidder was read, in which that gentleman advised the secretary that he could not, at this meeting, make the promised address on air brake practice.

#### Proposed Changes in By-Laws.

Mr. Morris: Under the head of new business I would suggest that the By-Laws be revised. As they stand now it requires that a month's notice be given before action is taken. We have found in the year's work that there are a few sections that do not just fit in exactly. I therefore move that the By-Laws be changed as follows, action to lie over until the next meeting:

Section 3 to read: "Meetings shall be held at such time and place as may be designated by the executive committee."

Section 4: "A quorum shall consist of fifteen members."

Section 10: Add, after the completion of the section, the words, "and the President shall act as chairman."

Section 11: After the words "Private Line" and before the words "may become" add, "or any person interested in car department matters." At the present time, according to a strict construction of the By-Laws, only those connected with the car department of a railroad or private line can become members, and I think it was the intention of the association to allow any one interested in car department matters, supplymen, or any one else, to become members.

Section 17: Omit the second number. The motion was carried.

#### Some Interchange Problems.

The association then took up consideration of disputed cases, the first being thus stated:

"In August, 1898, A receives from B one of A's cars with one pin and link drawbar having spindle rear end attachments (pocket attachments being standard to the car). Attached to the car was B's M. C. B. repair card to show that the repairs were made by B. A requested B to furnish M. C. B. defect card or sign joint evidence statement, to be used as authority for counter bill, to which B replied that the car was not stenciled showing that it was originally equipped with pocket attachments, and declined responsibility for wrong repairs made by them."

Mr. Shannon: I hold that B should either issue a defect card or sign joint evidence card, from the fact that the car was not stenciled when passed at interchange point.

A member: It seems to me there is nothing in the rules that requires cars having pocket attachments to link and pin drawbars to be stenciled showing that pocket attachments are standard, and that the case is covered by that rule which relates to the matter of furnishing joint evidence for such wrong repairs.

Mr. Smith: I think that as long as the car wasn't stenciled, they were not required to put in a pocket drawbar.

Mr. Stuckie: How would you know what was standard to the car, it not being stenciled? Maybe the pocket was wrong.

Secretary Sharp: I move, as a sense of this meeting, that B should sign joint evidence card for wrong repairs made by them.

Seconded.

Mr. Morris: I do not see what good a joint evidence card would be. That card is supposed to be held as protection against a bill being rendered. Now, if the repair card that was on that car calls for a wrong drawbar applied, what is there to show that a pocket bar was standard to the car? The owners of the car can't prove it; that is, the line making repairs would not accept it as proof. Each car must carry along with it evidence to show whether it is a pocket bar or spindle that is standard; and if there is nothing on the car to show that, I do not see what good a joint evidence card will be. The road that the bill is made against will not accept it; they will want some better evidence than that, and they will be justified in demanding it.

Mr. Hunt: The owner ought to know what is standard to his car.

A member: I would object to that on this account: You take it at interchange points of two roads, and both inspectors would know what was standard to the car. Take it down the line 50 or 100 miles after the car had been equipped with a link and pin drawbar, and they would not know whether it was a stem or pocket bar.

President Hunt: I hardly think that the fact that the man making repairs was unable to tell from the car what was standard would let him out. If he did not know, I think it would be his duty to find out. I do not think he would be justified in making wrong repairs, for the reason that he could not tell from the car what was standard. I think the car owner would still be justified in holding the party for the wrong repairs.

Mr. Morris: I move as an amendment to Mr. Sharp's motion that the owner has no redress—he cannot call for either joint evidence or M. C. B. defect card.

Seconded.

Mr. Smith: I think Mr. Morris is right, from the fact that the car had been delivered to the road who pulled out the drawbar. How would that man know what was standard? It might have gone to him with the other drawbar pulled out. A man would naturally go and look at the other end. He would be in a quandary to know what was right. I claim the car should be stenciled.

Mr. Shannon: There is nothing in the rules of 1897 that make it compulsory to stencil cars when equipped with link and pin drawbars. The party who applied the drawbar should have lived up to the original construction of the car and applied a pocket bar.

President Hunt: As I view it, we are at a loss to know what is standard, but there is nothing to save us in this matter at all. If we make wrong repairs, it is our loss. We must find out. The rules of '97 would not protect a man in making wrong repairs in that way. He still must make proper repairs.

President Hunt: There are lots of cars with pocket bars, and lots of cars with stem bars, that are not stenciled. The rules of 1897 say that cars equipped with couplers shall be stenciled, and says nothing about link and pin drawbars. So according to the rules the drawbars ought not to be stenciled any more than any other part of a car.

Mr. Callahan: I think that was left out of the rules of 1897 with the idea that link and pin drawbars were abandoned.

Mr. Keicott: We cannot go back; we have got to give up what they ask. Can anybody show anything in the rules requiring cars to be stenciled—anything in the rules that makes any exception to link and pin drawbars.

Secretary Sharp: In defense of the motion I made

I would just like to say that there is nothing in the 1897 rules, that I know of, that requires the owner of the car to stencil it; that is, when it is a link and pin drawbar, to indicate that it has pocket or spindle attachments. The rules are plain that a car equipped with an M. C. B. coupler must be stenciled. But this is a case of a link and pin drawbar; the party making repairs has acknowledged it by placing on the car, at the time of making repairs, an M. C. B. repair card. The rules do not make an intermediate road responsible—they do state that the parties making repairs are responsible to owners. But the card is on the car to show who did make repairs, and is a protection to the car owner, if the company delivering car to him will sign joint evidence, and I think we have got to accept the joint evidence card as authority. I do not think we can question for a moment the joint evidence card in a case of this kind. Mr. Morris said that the party making repairs would have a right to question whether the owner's evidence was correct. I do not think we should do that; I do not think it was the intention of the rules. I want to speak again in favor of the owner of the car. I think he should have a joint evidence card to offset the bill that will be rendered by party making wrong repairs.

Mr. Kroff: The instructions to repairmen, in reference to link and pin drawbars, is that cast, wrought iron, malleable iron or steel drawbars may be used when of sufficient strength and fitting properly. Now, I think that if the drawbar fitted properly, he was all right in putting in a stem drawbar.

A member: There is no objection to the drawbar; it is to the attachments.

Mr. Kroff: That is the instruction to repairmen, and I don't see if the car wasn't stenciled how that man would know what was standard to the car. What if you get an owner's car with a pin attachment and a pocket attachment with the owner, would it be a proper thing to demand an M. C. B. defect card from him?

President Hunt: As I understand it, the question is not with the drawbar, but with the attachments. It appears that the attachments were wrong and A wanted a defect card or a joint evidence card for these wrong attachments. No exception was taken to the bar proper.

Mr. Kroff: Suppose B broke one of those drawbars, how would he protect himself, just as in this case? If the car wasn't stenciled, B didn't know what to put in the car. The other end might have been wrong. He might have traveled from one end of the car to the other and got no satisfaction.

President Hunt: That would not let him out.

A rising vote on the amendment as made by Mr. Morris resulted: Ayes, 23; nays, 18.

A rising vote on the motion as amended resulted: Ayes, 30; nays, 18.

Secretary Sharp: The next case is stated thus:

"In July, 1898, a railroad company delivered a private line company's car home (stock car) with one water trough missing. There was no evidence of unfair usage. The owners demanded M. C. B. defect card, claiming that the trough could not be lost off under fair usage." 1. "Is not this a concealed part? (Rule 3, Sec. 24, 1897 Code.)" 2. "Should delivering line become responsible in the absence of direct evidence that the car had been in some accident, or had been roughly handled?"

Mr. Stuckie: I hold that the owners of the car should be held responsible for the loss of that trough. I think you will find that the rules in 1896 specify plainly that owners shall be held responsible for water troughs.

Mr. Grieb: A water trough is a concealed part of a car, and I think it is covered by Sec. 24 of Rule 3. As long as the car has not met with an accident, I believe owners are responsible for the trough.

Mr. Wensley: The rule says plainly "all inside or concealed parts of a car."

Mr. Shannon: A water trough in a stock car is not inside and is not concealed; therefore the delivering company shall be held responsible.

Mr. Morris: Would not the absence of that water trough leave an opening that would attract a person's attention; and if this is so, could it be called a concealed part?

President Hunt: That is just the point that occurred to me. If that trough was entirely inside of the car, I think the owners would have to be responsible. But if it forms a slat, as some of them do—a slat on the outside as well as a trough on the inside—I do not know but that the party delivering the car would have to stand it.

Mr. Deen: It forms a part of the outside—takes the place of a slat. It would be impossible for an inspector to overlook the water trough in inspecting a car. It is not a concealed part. I think that the delivering company should be responsible in a case of that kind.

Mr. Morris: In order to discuss this intelligently, we should know the construction of the car. Some water troughs—most of them—are outside; that is, they form a part of the side. Others are more or less inside, and I think unless we know what car it was, or the construction of the car, we could not very well say how the question should be settled.

Secretary Sharp: For the information of Mr. Morris and the other members, I will say that the water trough did form a part of the side of the car, as I un-

derstand the construction of the car from the name submitted here, and it was so arranged between the slats that it could be easily seen from the outside.

Mr. Wensley: I will say that the trough is on the inside of the car; isn't on the outside at all, yet it could be seen plainly from the outside.

Mr. Gierke: I have seen stock cars where the water troughs are handled by a controlling rod. Sometimes the controlling rod will get out of position and let the water trough fall back, and then it is hard to see whether the trough exists behind the side slats. If you don't look close you will think the water trough is missing.

Mr. Grieb: It seems to me from what has been said that it is acknowledged that the water trough is on the inside, and therefore Sec. 24 of Rule 3 places the responsibility on car owners. I would move that this be the sense of the meeting.

Seconded.  
Secretary Sharp: In defense of the owners, who, I see, are not represented here, I would like to make a little further statement, which I get from the papers submitted, and that is, that the trough is a long one, covering half the side of the car, and is held in position by three bolts or rods, that go directly through both sides of the trough, as I understand it. From the fact that there is a set nut on either side of the trough, making four nuts on the bolt, it is admitted by both parties that these nuts had been removed. Perhaps that will enlighten the members in their vote.

Mr. Mileham: In a case where a rod passes through a trough, fastened with a set nut, I do not see how it could be lost by fair usage. I think somebody wanted it worse than the owners and took it off. So far as

almost impossible for them to be missing under fair usage.

A member: Now, could not this valve be missing when the car was delivered to B, and what way has B of finding out?

Mr. Davies, Jr.: It is his place to test the brakes.  
A member: He has no way of testing them.

President Hunt: B could not claim that he delivered the car back to A in same condition as received, unless he knew that the parts were missing. He could not surmise that they were missing because they happened to be missing when he was giving the car back; he should know.

Mr. Stagg: But you know there is a section which says "all inside or concealed parts." We have got to acknowledge that this is a concealed part.

President Hunt: As I understand it, that section means parts on the inside of the car body. Brakes are not inside.

C. Deeu: I think if A delivered the car to B and B has no record of this defect when he received the car, when he returns the car to A if A's inspector finds that defect, B is responsible. But if it slips through A's hands and some other company finds it, B is let out and A is responsible.

The sense of the meeting on this matter was that delivering companies were responsible for contained parts of triple valves.

**Carding for Worn Out Brake Shoes.**

Mr. Morris: What is the practice among the railroad companies in Chicago in regard to asking cards for worn out brake shoes on cars received from connecting lines.

Mr. Deen: I do not know what the practice is; I

to make repairs, we can make bill. But the question I asked is can we bill owners for material and labor or do you bill under Sec. 4 for labor only?

A member: Bill for labor only.

Mr. Deen: The way I look at that rule is, that the material is missing on the line and all you can get would be for labor.

A member: As I understand that rule, if parts are lost upon the line the company making repairs in the course of time will become possessors of that scrap, and the rule was made that we should charge for labor only, and get the benefit of the scrap in the scrap pile, which would at some time come to the company making repairs.

Mr. Deen: It doesn't always come to the owner. I know of cases where couplers get pulled out of cars and when you go to get couplers you can't find them.

Dr. Davies, Jr.: As I understand Sec. 20, owners are responsible, not for the missing material, but for the labor only of applying the missing parts, the same as missing or worn-out parts, as it goes on to say in Sec. 4, Rule 5. I do not think that, according to Sec. 4 of Rule 5, you could bill them for the material, itself, only for the labor.

President Hunt: That is as I understand it. But should you do this same work against the delivering company, would you bill for material?

Secretary Sharp: Demand a condition card in a case of that kind.

President Hunt: That is the point I thought you meant to bring out at first.

Mr. Stagg: I do not think that means worn out parts; such parts are always cardable. But for worn-out parts such as brake shoes, anybody can demand a card in a common sense way. It looks here as though they should ask for card for worn-out brake shoes. That is what I cannot see any sense in. For lost parts, the delivering road is always responsible. If you have it on your own line as long as you lost it, you can charge for labor and nothing more. If you make wrong repairs, you are responsible for it.

President Hunt: I suppose it was put in there for a penalty; or, in other words, in order to maintain brakes in good condition.

Mr. Reinhard: It says in Sec. 1 of Rule 3, "Defect cards shall not be required for defects for which owners are responsible, except for material on cars offered in interchange as provided for in Sec. 28 of Rule 3." Sec. 28 says, "Material missing from body of car, except locks, grain doors and all inside or concealed parts of a car."

Mr. Davies, Jr.: It says defect cards shall not be required for defects for which owners are responsible. According to Sec. 20, owners are not responsible for parts of worn-out brakes if offered in interchange. So I hardly see where that comes in.

President Hunt: I fail to see the conflict there.

Mr. Davies, Jr.: Owners are not responsible for worn-out brakes offered in interchange.

Mr. Stocks: I do not think there is any conflict in the rules about worn-out parts of brakes; but I think there will be many conflicts amongst the men handling these cars. One man says they are worn-out and another man says they are not worn out. We receive a car from the Lake Shore; the car goes over our line to the Big Four at Kankakee; the brake shoes are worn out then. Perhaps not every man would call them worn out. The Big Four says they are worn-out. We will be compelled to issue a defect card for them to the Big Four.

Mr. Stuckie: Does it not say that the receiving road shall be the judge?

President Hunt: Always.

Mr. Stuckie: There is no chance for argument there; the receiving road is the judge.

Mr. Cook: It seems to me that this worn-out brake shoe is going to cause a great deal of trouble, if we live up to the rule. I would like to say it may be that the clerks will become a little interested if there are going to be arguments. Now, as all the different roads at Chicago are represented here, why not agree among ourselves on a uniform practice? No injustice was done to car owners under the old rules. If we receive a car from the Lake Shore with a brake shoe that is worn-out, before they have had a chance to make repairs, it does not seem to me justice to the Lake Shore that we should ask them for a defect card to replace a worn-out shoe on a New York Central car. Why not repair it, as last year, and make bill against the New York Central? The only thing necessary for us to do is to come to an understanding among ourselves so that there will be a uniform practice. I think that almost every one will agree that the old rules did justice to the owners in the matter of worn-out brakes. So let us be agreed, if it would be consistent, to treat that section as we did last year—charge owner with what we consider a worn-out brake shoe, no matter where we get the car from. If we all agree to that, it will be all right at Chicago.

Secretary Sharp: I move that we mutually agree not to ask for defect cards from each other for worn out brake shoes on cars offered in interchange.

A member: I would like to make an amendment to that, to include any worn-out part of a brake.

Mr. Cook: I think that is a little too sweeping. We

**THE ADVANCE IN TEN YEARS OF LOCOMOTIVE CONSTRUCTION.**

The larger locomotive shown in the sketch—built in 1898—weighs but 14 per cent more than the smaller—built in 1888—and pulls 50 per cent more. Both represent Chicago Great Western locomotives.

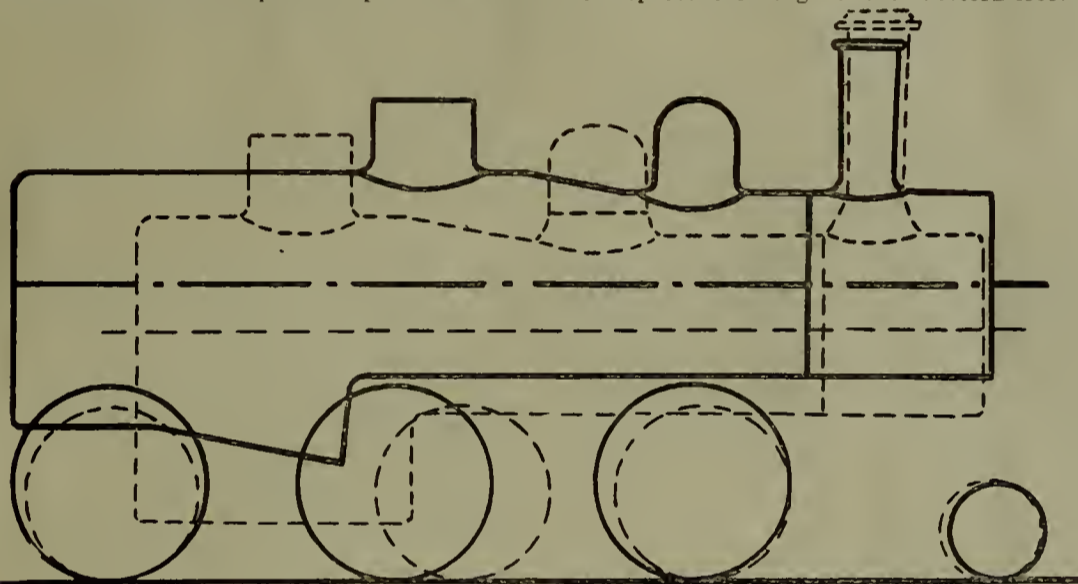

Scale = 3/16" = 1'  
19x28 Mogul. 18x24 Mogul.

Weight on Drivers.....	100,000	88,000
Total Weight .....	120,000	105,000
Traction .....	30,300	20,360

our cars are concerned, we frequently lose one, they being short. We find a great many taken off for other purposes.

A vote on the motion as made by Mr. Grieb was carried.

**Contained Parts of Triple Valves.**

President Hunt: We will now discuss the rules. I would ask if any of the members have discovered anything in the rules which they do not understand?

Mr. Stocks: I would like to ask the opinion of the members here on the question of slide valves and all concealed parts of the air brake—whether they are considered owner's defect, or whether the delivering company is responsible.

President Hunt: I think it is generally conceded that these parts of a car cannot be missing under fair usage.

Mr. Morris: The note under Sec. 20 covers that, I think, very completely.

A member: The delivering road may claim that it is a concealed part, the same as in Sec. 28.

Mr. Stocks: Suppose A delivers a car to B, who has no way of testing the brakes. The car goes down the line twenty or thirty miles and comes back. The car is attached up close to the engine and the air won't work. When car is returned to A, A finds out there is something wrong with the air. He has to take it down and finds the contained parts of the triple valve missing. B might claim that he got the car from them in the same way, but could not see the defect. That is what I was asking you about; whether they are concealed parts—whether the section as read there is absolute.

Mr. Davies, Jr.: We had a decision on that recently, which was to the effect that the company delivering the car was responsible for missing slide valves. It is

know I get a good many requests for brake shoes. I generally pigeon-hole them.

Secretary Sharp: Under Sec. 20 of Rule 3 we are given the privilege of asking cards for worn out brake shoes. I do not think it is the practice of those interested in Chicago interchange to do that; but there is a question there, and a conflict further down with Sec. 4 of Rule 5, which refers to billing. You will note in Sec. 4 of Rule 5, that bills may be rendered against car owners for the labor only of replacing couplers, drawbars, brake beams, including their attachments, which would mean heads, shoes, jaws, hangers, and so on. Now, that plainly states that you can only render bill for the labor of applying a brake shoe that is missing, while Sec. 20 says that owners are responsible for defective, missing or worn out parts of brakes which fail on car in fair usage, except cars offered in interchange. If a car on a line loses a brake shoe, can the company handling the car render bill against car owner for labor only, as specified in Sec. 4, Rule 5, or for labor and material, under Sec. 20, Rule 3? The note at top of page 28, Rule 5, also adds to the conflict.

President Hunt: Under Sec. 20 of Rule 3, the repairs would be made under a condition card. A condition card bears labor.

Secretary Sharp: I do not understand it so. It says defective brakes, which justify repairs—"owners responsible for defective, missing or worn out brakes which have failed under fair usage, except cars offered in interchange."

President Hunt: When the car is offered in interchange, the delivering company is responsible.

Secretary Sharp: I have a case with a western road. The car came in over our line with missing material. If we deliver the car to the owner with material missing, we become responsible under Sec. 20. If we elect

will have trouble on that if the head is worn-out, account of shoe missing.

Secretary Sharp: I do not think that we ought to interfere with the M. C. B. rules, in fact we cannot, but it seems to me if we just make some kind of a rule here among ourselves, that will cover Chicago interchange.

Mr. Shannon: If we confine ourselves to brake shoes what are we going to do with worn-out heads? A few days ago we changed four heads on a car on account of the eye being worn-out where the hanger is looped.

Secretary Sharp: A worn out brake head, account missing shoe, is unfair usage.

President Hunt: It appears to me that we are going contrary to what the rules say. I believe it would be a pretty good thing to let this matter take care of itself. I do not think we should go directly against these rules in our work here at Chicago, though we might agree to do certain things.

A member: According to what the rule says you are not going against it—defective, missing or worn-out parts. If a brake shoe is worn-out, owners responsible.

President Hunt: When offered in interchange.

Mr. Morris: This would be merely an agreement among ourselves. We need not interfere with the M. C. B. rules. We are not making ourselves traitors to them in any way. We have made such agreements a great many times and they have been of great advantage to us, and would be in this case. Worn-out brake shoes certainly should not be considered delivering company's defect.

President Hunt: If we receive a car and it is necessary to go on the road and the shoe is worn out, we must get a condition card or run it on the road with the old shoe. The object of the master car builders was to make rules to get the freight over the line and I was surprised when I heard that anybody was asking for worn-out shoes. That is a matter that should be attended to.

Mr. Cook: That is just the reason we want to settle on this one point. The rule as it reads, gives anybody that wishes to do so the privilege of asking a card for a worn-out brake shoe, from the delivering line. I think Mr. Sharp's motion should go through.

The motion as put by Mr. Sharp was carried.

The Association here adjourned to meet October 17.

The next meeting of the association will be the anniversary of its organization, which will be celebrated by a tour of the Belt Line, of Chicago. Mr. J. M. Warner, superintendent of that company, has kindly offered to run a train that will take in all the interchange points and Mr. Geo. A. Coe, superintendent of the Chicago & Erie Ry., has placed at the service of the association whatever coaches are needed for the members and their friends.

The train will leave Dearborn station at 9 a. m., Oct. 17, and besides stopping at the junction points will give the members an opportunity to inspect some of the important car shops and industries on the line, for which invitations have been received. Lunch will be served in the baggage car, en route, at the expense of the association.

Returning the train will arrive at Dearborn station at 6 p. m. The members will go direct from the station to the Great Northern hotel where a repast will be served at a nominal cost.

The regular meeting will be called at about 7 o'clock, when the election of officers will take place. A special feature of the evening will be an address on air brake practice by Mr. S. J. Kidder, of the Westinghouse Air Brake Co.

All members and those of their friends who are interested in car department matters are cordially invited to join the excursion, and those whose arrangements will not allow them to do that are requested to meet at the banquet in the evening. The committee in charge will later issue an invitation giving, in more detail, information about arrangements.

#### COMMENT BY CAR FOREMEN.

This column is edited by the Publication Committee of the Car Foremen's Association, and the RAILWAY MASTER MECHANIC is not responsible for any of the views expressed therein. Communications and items of interest to car men are solicited. T. R. Morris, chairman.

#### Section 20 Rule 3.

There was considerable discussion of the above important section at the September meeting of the Car Foremen's Association, and the decision arrived at received an almost unanimous support from the members present. It was to the effect that by natural agreement worn out brake shoes on cars interchanged at Chicago should be regarded as owners' defects. This is taken exception to by Mr. H. Valentine whose communication appears in another column, and who states that we have no right to ignore rules laid down for our guidance by the master car builders.

In the first place, the rules of interchange are supposed to be framed and put into force for the purpose of facilitating the movement of cars. We do not think the compilers will lay claim to infallibility as an attribute of their performance, nor will they object to

any body of men who have discovered weak spots in their production, making arrangements among themselves with the end in view of accomplishing still better results, even if by so doing they may modify slightly the rules as published.

The preface to the rules practically says the object is to make car owners responsible for defects due to ordinary wear and tear, and to do away with use of defect cards as much as possible.

Section 20 is in direct conflict, not only with the spirit of the preface but with the plain wording of the same. Why did not the master car builders, in their solicitude for the comfort of the receiving line, make the delivering company responsible for worn out wheels and for other defects on wheels that owners would ordinarily be charged with? Consistency demands it. If, as has been argued, worn out brake shoes are to be charged to delivering company as a penalty for giving another line a car in bad order, logically, the greater the offense the greater the need for a penalty, and defects noted in sections 2 to 12 A, inclusive, of rule 3, should be classed as owners responsible, "except on car offered in interchange."

There does not seem to be any excuse for this paternal protection of the receiving line. It is not generally known that they have suffered to any great extent on account of being compelled to take a car from another company with one or more brake shoes worn out. When such cases arose the shoes were removed, charged to owners as they should be, and there the matter ended, with no writing for defect cards, no squabbling about condition of shoes and "no kick coming" from any one. Certainly if this new departure is correct, on principle, it should be made to include other parts.

#### Arbitration Case 513.

The article in this column in the last issue of the Railway Master Mechanic on Arbitration case 513 has called forth a number of expressions of opinion favorable to the revision of the decision. A recent case which occurred in Chicago showed clearly the injustice of making owners responsible for missing end gates. A coal car loaded with heavy machinery, with high sides and end gates, securely fastened by rods and bolts, and sheet iron bands on the corners, was delivered to a certain firm on its track. In order to easily handle the machinery, the corner bands on one gate, which were secured by rivets, were removed by cutting off the heads. There were 64 of them. When the car arrived at the main yard on its way home, an inspector noticed the missing end gate, and sent the car to the repair track. An effort was made to locate the gate, but no trace of it could be found, although the firm to whom the freight had been consigned claimed to have put it in the car after unloading the machinery. Bill was of course made against the owners.

#### The Man Behind the Gun.

Our recent war with Spain has forced an acknowledgement from the outside world that our sailors are the peers, if not the superiors, of any afloat; and that in our citizens ashore we have the material from which we can make better soldiers in a shorter time than any other nation on earth. The common man, by which is meant in this instance, he of the rank and file, is having his innings. In this country of intelligent and educated men it does not follow that the mere fact of a man's being an officer necessarily makes him a superior sort of being, nor does it follow that because a man be in the ranks, he is there because he is incapable of rising to a higher plane. We have not enough positions of trust and responsibility to go around among the number capable of filling them. These remarks apply not only to the army and navy of our country, but to another great army—the railroad men of America. There is no desire to detract in any way from the credit that justly belongs to any one of the different classes who has been receiving praise for the part he takes, but rather to give to him whom no one has considered it worth his while to mention that credit which is his due.

The man behind the gun on board one of our fighting ships has his counterpart in the machinery department of our railroad in the person of the car inspector. While it may be going too far to say, as it is recorded that one of our eastern railway presidents did, that "the car inspector is a bigger man than the general manager of our line," still anyone acquainted with the duties performed by this one cogwheel in the great machine called a railroad must acknowledge that upon him depends in a great measure the success of the running of the trains. Of what use would it be for the heads of the car departments to meet each year and formulate rules for the safe and rapid movement of cars unless the car inspector has the judgment to carry out the instructions? Upon whose shoulders rests the responsibility of making the interchange rules a success, or of demonstrating their impracticability? A train leaves the terminal point laden with a precious cargo of human lives, and property worth thousands

of dollars, and upon the safe arrival at its destination credit is given to the engineer and conductor, and to them alone. The underpaid and unappreciated car inspector, who has discovered and cut out cars with defective and dangerous wheels, unsafe draft rigging or defective brakes, and who has helped to make this result possible, is wholly ignored. It must be understood also that his work is often done under great disadvantages. He does not have his cars taken to a round-house and kept there until he has had time to thoroughly examine each part as is the case with the engineer and his locomotive. On the contrary he has a train of from 40 to 50 cars, which he must look over in a given time, and the failure to find a small crack in a cast wheel or one worn out, may result in a wreck that will cost his company more money than he can earn in his whole life-time. You who are skeptical on this subject try and decide whether there is not some excuse for a man failing to discover a defective wheel at night by the uncertain light of a lantern or torch, with the snow two feet on the ground, the thermometer 20 degrees below zero and the wind blowing a gale; or on a dark blustering rainy night, the water pouring down from the roof of the cars on his head in small rivers, and ankle deep between the tracks. Consider the enormous number of trains that are in motion on the railroads of the United States at any given moment of the day or night, and the infinitely small proportion of wrecks that can be traced to the neglect or incompetency of the car inspector. The demands on the judgment of this man, who according to one authority, must necessarily be without brains because he works for small wages, are continuous. He must not only prevent palpably unsafe cars from going out on the road, but he must exercise judgment in allowing partially defective cars to run, and foretell that they will arrive at their destination safely, taking into consideration when forming this prediction the condition of the track, season of the year, weight of load, speed of train, general build of car, etc. He probably does not reason it out in this way, but arrives at a conclusion intuitively, as it were, as a result of long observation and a thorough knowledge of his business.

A superintendent of motive power, some time since, was shown a cracked wheel and remarked that he considered it almost a miracle that it was discovered by the inspector. Yet these miracles are being performed every day and night.

The interest taken in mechanical associations by the car inspectors during the last few years is one of the signs of the times, and shows that as a class they are keeping step in the march of progress. This should be encouraged by the heads of the mechanical departments, as any improvement in the intelligence and efficiency of the men means a corresponding benefit to the railroad companies.

It is not the intention of this article to glorify the car inspector (although I certainly deprecate the very serious reflections that have recently been made on him), but to show him in his proper light and to give him credit that justly belongs to him. T. R. M.

#### Communications.

##### Responsibility for Worn Out Brake Shoes.

Sept. 14, 1898.

To the Editor:

It occurs to the writer, that the Car Foremen's Association did wrong in passing a resolution "to ignore the rules, relating to worn brake shoes." We are undoing what we know has been carefully considered and thoroughly discussed by our superior officers. We are establishing a precedent that may have serious consequences; by continued tinkering with the rules, we are apt to make some vital mistake. Of course we organized and meet to discuss and improve on these very rules, but have we a right to say we shall ignore them, in whole, or in part? Will it not place some members in a very unpleasant position? At any rate, I have reached the conclusion, that in this instance our discussion was not thorough, did not reach far enough; we take up one section, pull it to pieces and find fault without taking into consideration the interest and spirit of the entire rules.

The preface is concise and clear; taken together with rule 1, it practically answers all the points brought up in our discussion. The framers of the rules want "Owners to be responsible for their cars and to pay for all ordinary wear and tear damage." Yet they want the roads handling them "to give them the same care, etc., as they do their own cars."

Sections 18, 19, 20 of rule 3 are not conflicting. Owners are intended to be held responsible as stated in the preface, provided, however, "the cars are given the same proper care and attention that are given your own cars." Sec. 1 of this rule requires defect cards, and Sec. 19 makes delivering road responsible for missing materials; this is a penalty or punishment, and a proper one for not having observed rule 1.

In ignoring this rule you are inviting neglect of your own equipment. The brake shoe is an article carried most anywhere; put it on; don't let the car run until the heads are worn. A. Valentine.



## Credit for Broken Couplers.

To the Editor:

Under a literal interpretation of Sec. 10 rule 5 it seems that one can not expect credit for more than the actual weight of broken parts of M. C. B. couplers or knuckles removed from a car. As an illustration, if a car is received at a repair point with the coupler broken off in the shank, and only the rear portion attached to the pocket is in position, a credit for same would be proper, although the road making repairs will have the other portion of the coupler body in its possession, and it will sooner or later receive it at its scrap pile and thus get the benefit of scrap for which the owner will not receive credit.

This hardly seems to have been the spirit of the framers of the present rule, nor is it according to the past year's practice. Still taking the rule as it stands, it certainly warrants such action.

I think it would be well to have this point thoroughly ventilated to determine the proper course of action before bills for repairs are held in dispute pending a decision from the arbitration committee. It is with this idea in view that I broach the question. J. C. G.

## PERSONAL.

Mr. E. H. Ellersbe has been appointed general storekeeper of the Georgia & Alabama.

Mr. Boaz Rossiter, formerly foreman of the shops of the Detroit, Grand Haven & Milwaukee, at Detroit, Mich., is dead.

Mr. B. S. McClellan has been appointed master car builder of the Fort Worth & Denver City, with office at Fort Worth, Texas.

Mr. Wilson Eddy, formerly for many years master mechanic of the Boston & Albany, died at his home in Springfield, Mass., Sept. 2.

Mr. T. S. Horiye, general manager of the Tokio Car Works of Tokio, Japan, passed through Chicago this month on a tour of inspection.

Mr. John W. Shannon, inspector for the Westinghouse Air Brake Company, with headquarters in Buffalo, died in that city Sept. 10, aged 47 years.

Mr. F. R. F. Brown, late mechanical superintendent of the International, is said to have fallen heir to \$50,000 through the death of a relative in England.

Mr. Frank Brown, hitherto assistant to the purchasing agent of the Baltimore & Ohio Southwestern Railroad, has been made purchasing agent of that road.

Mr. O. M. Laing has been appointed purchasing agent of the Seattle & International at Seattle, Wash.; he will continue his present duties as cashier of that road.

Mr. John Foulk has been appointed master mechanic of the Litchfield, Carrollton & Western, retaining his present similar position on the Jacksonville & St. Louis.

Mr. W. H. Garlock has been appointed master mechanic of the White Pass & Yukon Railway, now under construction in Alaska, with headquarters at Seattle, Wash.

Mr. E. E. Anderson, heretofore train master of the Georgia & Alabama, has been appointed purchasing agent and assistant to General Manager Gabbett of the same road.

Mr. W. A. Stone has been appointed master mechanic of the Detroit, Toledo & Milwaukee, vice J. W. Whitmer, resigned. Mr. Stone's headquarters are at Marshall, Mich.

Mr. W. E. Killen, superintendent of motive power of the Chicago, Peoria & St. Louis and St. Louis, Chicago & St. Paul, has removed his headquarters from Springfield to Jacksonville, Ill.

Mr. W. I. Cooke has been appointed superintendent of locomotive service of the Chicago & Eastern Illinois, with headquarters at Danville, Ill., vice Mr. H. A. Dewey, resigned to engage in other business.

Mr. Wm. Thow, chief mechanical engineer of the government railways of New South Wales, is in this country on a tour of inspection. For several weeks past he has been visiting shops in Chicago and vicinity.

Mr. Theodore W. Sloan has been appointed foreman of car department of the Illinois Central at New Orleans, vice B. S. McClellan resigned to become master car builder of the Fort Worth & Denver City.

Mr. H. C. Wornhledorf, late general foreman of the St. Louis Southwestern Railway, with headquarters at Tyler, has been appointed foreman of car inspectors over the entire line of the Texas & Pacific Railway.

The jurisdiction of Mr. Jas. Meehan, superintendent of motive power, of the South Carolina & Georgia has been extended to cover the Ohio River & Charleston Railway, which is now being operated by the first named road.

Mr. B. S. McClellan has been appointed master car

builder of the Fort Worth & Denver City, with headquarters at Fort Worth, Texas. Mr. McClellan has hitherto been foreman of car department of the Illinois Central at New Orleans.

Mr. A. F. Agnew has been appointed roundhouse foreman on the Duluth, South Shore & Atlantic railway at Marquette, Mich., vice Mr. G. A. Gallagher, resigned to become mechanical superintendent of the Duluth, Mississippi River & Northern.

Mr. G. A. Gallagher has been appointed mechanical superintendent of the Duluth, Mississippi River & Northern, with headquarters at Swan River, Minn. Mr. Gallagher has hitherto been roundhouse foreman at Marquette, for the Duluth, South Shore & Atlantic.

Mr. T. Y. Dzushi, chief of finance and manager of stores of the Imperial Government Railroads of Japan, who has for some time been visiting the United States investigating our railway methods, particularly in the line of purchasing supplies, has gone to Europe on a similar mission.

Mr. Frank Brown, assistant to the purchasing agent of the Baltimore & Ohio Southwestern, has been given the title of purchasing agent of that road, with office, as heretofore, at Cincinnati, Ohio. The duties of purchasing agent have heretofore been filled by Vice-President W. W. Peabody.

Mr. T. M. Downing, master mechanic of the Columbus, Sandusky & Hocking, at Columbus, has resigned and the duties of the office have been assumed by the superintendent. The mechanical department is in direct charge of Jackson Richards, general foreman mechanical department, and John Worhle, general foreman car department, and these will hereafter report to the superintendent.

Mr. John G. McLaren has been appointed general foreman of the Chicago & Erie at Chicago, in charge of both the car and motive power departments, via Mr. W. E. Sharp, resigned to become assistant to the superintendent of the car shops of the Armour Car Lines. Mr. McLaren's appointment comes in the nature of a direct promotion, he having been for the past 12 years foreman machinist in the Chicago & Erie shops at Chicago.

John Hill, Sr., died at his home in Chicago, Sept. 10. Mr. Hill entered the employ of the Chicago, Rock Island & Pacific when a boy years ago, remaining with the road up to the time of his death. For forty-four years he was an engineer on the Rock Island and he was one of the founders of the Brotherhood of Locomotive Engineers. He also belonged to the Brotherhood of the Footboard, an engineers' organization which existed during a serious strike in 1863. A lodge of the Brotherhood of Locomotive Engineers in Indiana bears his name.

Mr. Alfred Lovell has been appointed assistant superintendent of motive power of the Northern Pacific, with office at St. Paul. Mr. Lovell will have charge of the routine business of the motive power office during the absence of the superintendent of motive power. He will also attend to such special work at the shops, and on the line, as may be assigned to him. Mr. Lovell has hitherto been engineer of tests of the Northern Pacific.

Mr. Horace R. Hobart, editor of the Railway Age, has resigned, to engage in private business. Mr. Hobart has complained of being "tired out" for several years, and with good cause for he has been the editorial backbone of the Age for the past twenty odd years—from the starting of the paper until his retirement, in fact. Mr. Hobart will not become an idler by any means, but his work as an investment agent and broker will, we trust, be easy as compared with the inexorable editorial grind which has been his lot for so many years. Mr. Hobart's many friends wish him all good fortune in his new venture.

Mr. W. E. Sharp has been appointed assistant to the superintendent of the car shops of the Armour Car Lines, with office at 45th street shops, Chicago. Mr. Sharp entered the service of Chicago & Atlantic Railway (now Chicago & Erie) at Huntington in the spring of 1890 as a laborer in the car department. He worked in the capacity of car repairer and car inspector until September, 1892, when he was promoted to be car foreman and was placed in charge of all repair work and interchange of cars at Chicago. In October, 1894, he was promoted to be general foreman in charge of both the car and motive power departments at Chicago. On Sept. 30 he resigned this position with the Chicago & Erie to accept the position with the Armour Car Lines, above noted.

## SUPPLY TRADE NOTES.

—The American Steel Castings Company is making cast steel driving wheel centers for 150 locomotives.

—Manning, Maxwell & Moore are furnishing Reed milling machines and lathes, grinders, and an Acme nut taper to the Rock Island Arsenal.

—The Pratt & Whitney Company of Hartford,

Conn., has sent a representative to Europe on business connected with its small tools department.

—The Keystone Axle Company of Pittsburg is just about starting its plant. It has its machinery now in such shape that perfect axles are made by its process.

—The C. H. Haesler Company, manufacturers of pneumatic tools, on October first moved their offices from 1026-1030 Hamilton street to the southeast corner of Twelfth and Hamilton streets, Philadelphia, Pa.

—The Vulcan Iron Works Company of Toledo, manufacturers of steam shovels, excavators, boiler fronts, etc., are issuing a handsome hanger, bearing in colors a naval lad waving our nation's flag. The coloring is excellent.

—Mr. George E. Martin, formerly with the Westinghouse Electric & Manufacturing Company, of Pittsburg, Pa., has been engaged as mechanical engineer by the Springfield Manufacturing Company of Bridgeport, Conn.

—The Hancock Inspirator Company has just gotten out a new device—the Hancock composite injector. It consists of two separate and independent injectors combined in one body and arranged to discharge through one and the same pipe.

—The Chicago grain door was specified on 600 Northern Pacific box cars recently let to the Michigan-Penninsular Car Company and Illinois Car & Equipment Company, also on the 1,000 C. M. & St. Paul box cars to be built at the West Milwaukee shops.

—Watson & Stillman of New York are sending eight large hydraulic presses to Germany, France and England. This firm recently received an order for a 42-in. punching press and a special pipe shear designed specially for the trimming of especially large diameter seamless drawn steel tubing.

—Gould & Eberhardt of Newark, N. J., are furnishing eight large drill presses for the Rock Island Arsenal, a large drill press for the Brooklyn navy yard and several large shapers for England and Scotland. They have recently had orders for a large number of automatic gear cutting machines for all parts of the world.

—The Westinghouse Air Brake Company, which some time ago received a heavy order from the Russian government for air brakes for the Siberian Railroad, is building tools and machinery for an air brake plant in Russia, the government having given the order for brakes on condition that they be manufactured in that country.

—Mr. F. F. Whittekin, formerly with the Denver & Rio Grande, the Western New York & Pennsylvania and the Pennsylvania, has been appointed consulting engineer and technical director of the Antioquia R. R., of the United States of Colombia, with office at Medellin. He will have charge not only of engineering but of the motive power department.

—The Westinghouse Electric & Manufacturing Company of Pittsburg, and the Walker Company of Cleveland, have been practically merged. The two companies will maintain a separate organization, but some of the principal owners of the Walker Company go on the board of directors of the Westinghouse company. The Westinghouse company purchases the bulk of the stock and bonds of the Walker company.

—Williams, White & Co. of Moline, Ill., recently shipped to the Kewanee Manufacturing Company a number of machines for making brake beams, including two bulldozers with dies for shaping metals, three bulldozers for general work, three vertical punching and shearing machines which automatically clamp, punch and shear the sheets, and another vertical press for riveting. The company also recently had an order for a taper rolling machine, for rolling axles, tapering bars, etc., to go to Russia.

—The Consolidated Safety Valve Company of New York recently issued a handsome trade catalogue in which are described and illustrated their various lines of goods—pop safety valves, water relief valves, cylinder relief valves, muffling attachments, etc. The illustrations are excellent, and the descriptive text rather more satisfactory than that commonly found in catalogues. Some very valuable technical data is also given. The company will send the book to any one on application to its office, 111 Liberty street, New York.

—Mr. J. W. Duntley, president of the Chicago Pneumatic Tool Company, has just returned from a somewhat extended trip to the Pacific coast, extending as far as Victoria, B. C., and has met with the most flattering success in the introduction of the company's tools and in securing new orders. Owing to the large amount of business developed by him on the coast, the company has decided to open an office in San Francisco for the convenience of its patrons, and will be represented there by Mr. Henry Engles, 537 Mission street, San Francisco, Cal.

# THE MARK EQUIPMENT COMPANY.

536 Monadnock Building, CHICAGO, ILLS.

OUR SPECIALTIES

## Track Equipment

It is the Best  
But Not the Cheapest  
A Poor Article  
Is Dear at Any . . . .  
Price.

### THIS BRACE BRACES

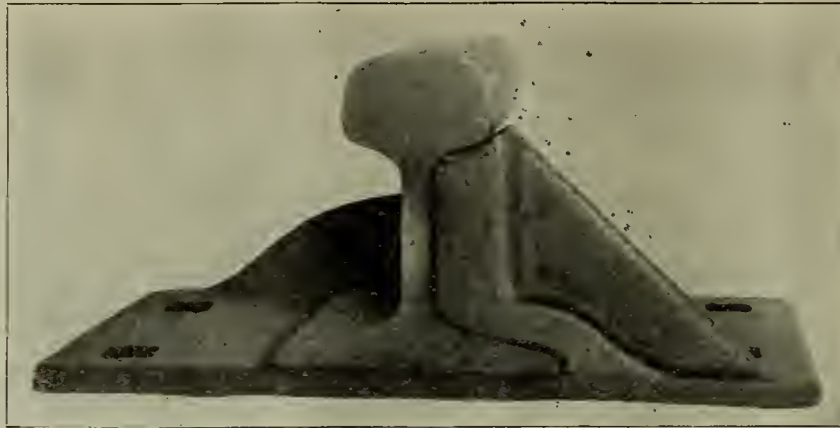

C. E. MARK, Manager.

ESPECIALLY ADAPTED  
FOR CURVES . . . . .  
BRIDGE APPROACHES AND  
SWITCH TRACKS

IF A  
**BRACE**

IS REQUIRED . . . .  
THEN IT IS  
DESIRABLE TO  
SECURE  
THE BEST

If it meets your ideas write us, and let us know if this advertisement is of any value. We have the finest testimonials ever given. All in one piece. Goes on the rail at any point, and is made of metal that cannot be broken.

# THE CLOUD STEEL TRUCK FRAME

## FOR FREIGHT CARS OF ALL KINDS AND LOCOMOTIVE TENDERS.

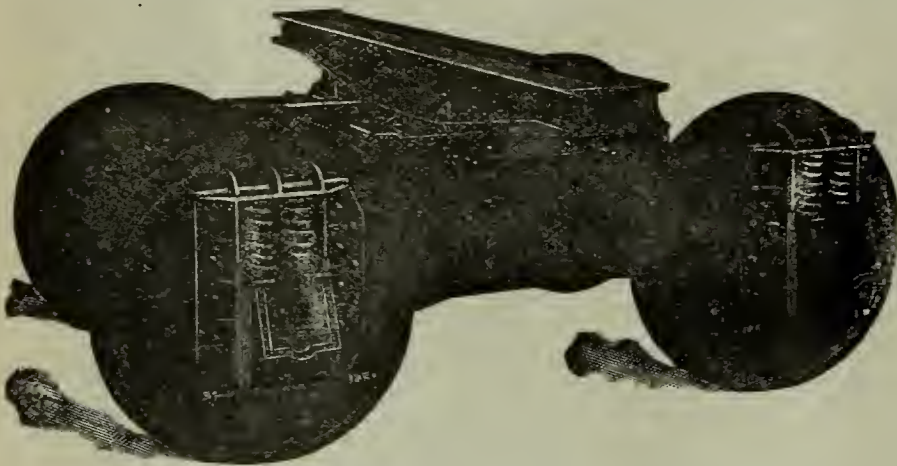

THE CLOUD STEEL TRUCK FRAME  
WITH BETTENDORF I BEAM STEEL BODY BOLSTER

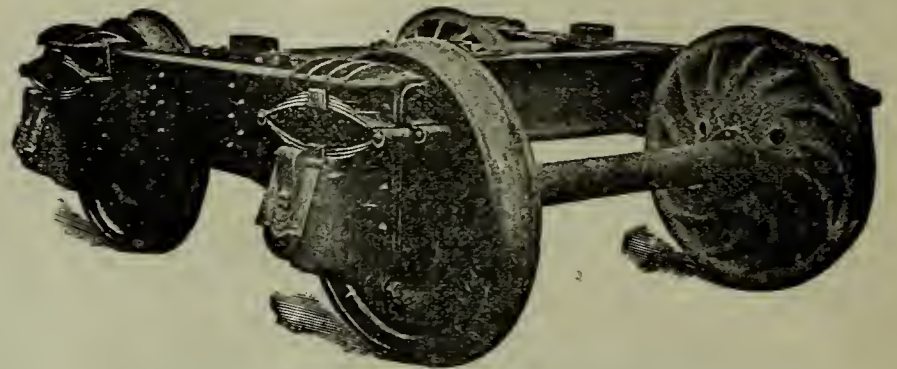

THE CLOUD STEEL TRUCK WITH ELLIPTIC SPRINGS—  
FOR LOCOMOTIVE TENDERS, STOCK CARS, ETC.

## Bettendorf I Beam Steel Bolsters



SIDE VIEW BODY BOLSTER.



BOTTOM VIEW BODY BOLSTER.

### SPECIAL ADVANTAGES.

Fewest Parts—Straight Line Flanging—Ease of Making Repairs—Perfect Spring Action—Use of Small Section Coil Springs, insuring thorough tempering—Wide Bearing of Pedestals against Boxes—Use of Elliptic Springs instead of coil when desired—Best Materials and Workmanship.

"These elements—lightness, stiffness, squareness, are earning money every mile that a truck runs"—*The Railroad Gazette*. The Cloud truck is in extensive and successful use. Send for further particulars regarding this and our I beam steel bolsters. Works at South Chicago.

THE CLOUD STEEL TRUCK CO., 1425 Old Colony Building, Chicago.

# THE GRAVITY CAR COUPLER.

## AN ABSOLUTELY AUTOMATIC COUPLER.

### Cuts the Cost of the Vertical Plane Type in Two.



NO PINS TO BUY.

NO KNUCKLES TO BREAK.

THIS COUPLER takes the ordinary Link.  
Is always ready to couple.  
Works on heaviest curves.  
Gives a center draft.  
Is compact, light and strong.

The latch cannot jump up, or creep up, and release link by motion of the cars.

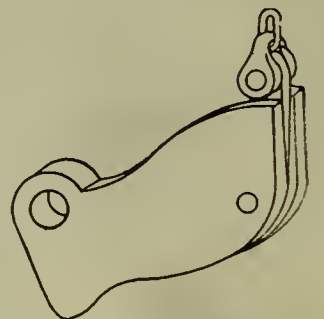

The Latch.

IT HAS STOOD THE SEVEREST SERVICE TESTS IN MOUNTAIN AND YARD SERVICE FOR MONTHS. WEIGHT, COMPLETE, 145 LBS.

For details address

The Gravity-Car Coupling Co., Colorado Springs, Col.

# RAILWAY MASTER MECHANIC

WALTER D. CROSMAN, Editor.

EDWIN N. LEWIS, Manager.

PUBLISHED MONTHLY BY

THE RAILWAY LIST COMPANY.

Devoted to the interests of railway motive power, car equipment, shops, machinery and supplies. Communications on any topics suitable to these columns are solicited.

Subscription price \$1.00 a year, to foreign countries \$1.50, free of postage. Advertising rates given on application to the office, by mail or in person. Address

THE RAILWAY LIST COMPANY,

The Rookery, Chicago, Ill.

The Official Railway List is published by this Company.

VOL. XXI. CHICAGO, NOVEMBER, 1898. No. 11.

THERE is a considerable variety of opinion as to the practical efficiency of using the air pump exhaust steam for purposes of feed water heating. Theoretically there should be a noticeable effect upon the coal pile. There are those who claim that in practice this effect is not appreciable. On the Northern Pacific it is felt that there is undoubtedly some saving, but we believe that on this road the actual amount of saving has never been accurately determined by experiment. It will be remembered, however, on the other hand that Mr Barnes claims that on the Wabash carefully observed results show a saving in fuel of 10 per cent in some cases the economy in fuel running as high as 15 per cent.

THE tests of locomotive boiler coverings on the Chicago & Northwestern Railway, to which we have before referred, have been completed, but publication of the results of these tests is, for the time being at least, withheld. We understand that there was developed but a very slight difference in the relative efficiency of the various coverings experimented with. But we further understand there was very conclusive testimony obtained as to the extreme value of having the parts of the locomotive exposed to radiation properly protected. We trust that the results of these tests will be permitted to come before the public in such an authentic manner that the lesson conveyed will be duly impressive—the lesson that not only is there to be a material economy gained by the careful use of insulating coverings, but that these coverings should as far as possible be applied to all, and not a part, of the exposed surfaces.

TROUBLE with journal bearing linings is not at all uncommonly met with and it will be of interest to know how one road has found a way out of such trouble. The Lake Shore & Michigan Southern road had, until three months ago, used for many years a pure pig lead lining. It found, however, that under heavy cars there was developed with this lining a peculiar disintegration of the lead, by which it seemed to lose its life. Spots, sometimes of considerable size, would crumble and drop out, the spaces thus left in the lining filling up with a mixture of lead and dirt, which was sure in the end to produce a hot box. As a result of this experience, it was decided to try a new lining, the formula for which was as follows: Lead, 100 lbs.; antimony, 5 lbs.; tin, 5 to 7 lbs. Solid bearings are used and lined with a 3-16 in thickness of this antimonial lead. With this new and harder lining, the peculiar conditions met with the pure pig lead lining seem to have disappeared.

It was a suggestive point that Mr S. J. Kidder made in his address before the Car Foremen's Association, published elsewhere in this issue, when he directed attention to the necessity of carefully watching the pneumatic water raising system in our sleeping cars. When this water pressure apparatus is in normal condition the air brake system is not interfered with in any serious way, but when it

is not properly maintained, he says, it becomes a disturber of the stability of the air brake system. He suggests that the occasional mysterious actious of the brakes may at times be cleared up by an understanding of the water raising system. It is well that attention should be directed to this point, for the demands upon the air brake pressure are multiplying. We have not only the water raising system of the Pullman cars, but we find that upon the engines the air is being drawn upon to operate sanders, bell ringers, reversing gear, cylinder cocks, ash pan honpers, etc. Every point of draft upon the supply of air primarily intended for the safe handling of the train should be carefully watched.

ELSEWHERE in this issue we publish an interesting table showing the relative frequency of breakage of M. C. B. coupler knuckles for the eight years ending March 31, 1898. Information of this nature has not been published for some time, and the table will be studied with interest by those who are watching the development of the coupler situation. It will be seen that by far the larger part of the trouble with knuckles is shown by statistics to be with the upper lug, where common observation has long placed it. There has been an interesting development in regard to this upper lug, the percentage of upper lugs "off" gradually growing smaller, from 31.52 per cent in 1891 to 23.82 per cent in 1898. The cracking of the upper lug, however, has increased from 10.44 per cent in 1891, to 27.84 per cent in 1898. The lower lug seems to be faring very well, only a very small percentage of these members being broken off, cracked or chipped. This supports our contention made in our last issue, (when referring to the strengthening of the M. C. B. coupler) that the strengthening of the lower lug, the plan for which was then discussed, did not appear pressing—necessity. We direct attention to the table itself for further study of the peculiarities of these statistics.

## MEASURING FUEL CONSUMPTION IN LOCOMOTIVE TESTS.

In a recent issue of the Stevens Indicator, a scheme for testing locomotive boilers in fast express service on comparatively short runs, is presented by Mr. Howard H. Maxfield. In this an effort is made to show that the method of estimating the amount of fuel in the fire box just at the time the locomotive starts with the train, and just at the time the locomotive stops at the end of the run, which method has been accepted practice for several years, is quite wrong. It is argued that a better method for finding the exact fuel consumption on a short run in express service is to start the tests in the round house with a banked fire and end the test in the round house with the fire banked. The method then is to observe the amount of water passing the meters between the time of beginning the test in the round house and the time of starting with the train, between the latter time and the time of stopping with the train at the end of run and also between this time and the time of banking the fire again. Then the total water passing the meters, divided by the total fuel used, gives a rate of evaporation which is assumed to be the rate of evaporation per pound of fuel from the time the fire is started until the fire is banked again; and dividing this quantity into the quantity of water which passes the meters during the time the train is in motion gives a quantity which is assumed to be the total fuel used to haul the train and, of course, to run the locomotive.

It will be observed that this method is recommended to be used for only short runs. The object in this is not quite clear because whatever the method pursued in estimating, or measuring, the amount of fuel in the firebox at the beginning and at the close of a test, the percentage of error decreases with the increase of total fuel used during the test. The method pursued by Prof. Goss, in tests on the Purdue locomotive testing plant, of having the fire in good condition and continuing so to the instant of stopping the test, is approved, evidently; the method is, no doubt, a good one and, quite contrary to what seems to be the author's idea, there is no reason why the same course should not be pursued in road tests. Such method is now generally used in road tests by those who are thoroughly abreast of the times. Perhaps it is a little

wasteful to run into a terminal station with a full fire, but the cost of the coal so used on a test is a very small per cent of the total cost of the test.

It seems hardly possible to recommend as a method of finding the amount of fuel necessary to haul a train, one that requires the test to begin in the round house several hours before starting with the train when the simpler, and at least just as exact, method of maintaining the fire to the moment of stopping at the end of the run is so much more convenient for all concerned and can be followed at no greater cost.

## NOTES ON THE M. C. B. COUPLER.

It has become of late quite popular to criticize the M. C. B. coupler, and sometimes it seems, almost, as though the criticisms were made with malicious intent. The Railway Master Mechanic has made some observations concerning the best methods to be pursued in an effort to adapt the couplers to the very heavy cars now in use and has pointed out some of the defects of the device, but whatever has appeared in these columns has been written with the best intentions possible, both for the user and the manufacturer of couplers. The fact that the M. C. B. coupler has been of inestimable value to railroads cannot be successfully disputed, but it is quite natural that, having gained so many advantages with the device other advantages should be sought to be gained.

There is no questioning the fact that great improvements can be made in, and wrought by, the M. C. B. couplers; the word "couplers" is made plural intentionally because it is believed that the greatest benefits are to be derived from a manipulation of several couplers, or, if possible, all couplers. There is much inconvenience, to place it mildly, experienced from the use of metal unsuited for use in couplers, but the remedy for this, the purchase of couplers made of the best material, is in the hands of every railroad. The greatest need now is for a knuckle that can be used in any draw-head, or, to go to the root of the evil, for the adoption of a universal locking device and the adaptation of coupler heads and knuckles to the use of such locking device. However, a moment's thought makes it apparent that a universal knuckle cannot be used without using a universal locking device and with a universal locking device and knuckle adopted the entire coupler would become universal.

There are ways in which the "coupler question" may be manipulated to the advantage of all concerned, but it is hardly fair to the coupler, or to those who designed it, to consider only the charges which can be brought against it; a sheet of "credits" should also be prepared if an impartial comparison is to be made. First to be mentioned on the credit side is the improvement in switching facilities gained by its use. While it is claimed that cars equipped with the M. C. B. coupler must be "ridden," to insure that the knuckles are open and in position to engage when coupling is desired, or that the lock be held open when coupling is not desired, nevertheless, if such "riding" be insisted upon, breakage of parts other than the coupler will be greatly reduced in number. It is quite certain that a train made up of cars equipped with the M. C. B. coupler will not be prevented from "getting somewhere" by a break-in-two, and while the value of this fact to the railroads can be estimated with difficulty, that value can scarcely be placed too high. There is a saving, however, resulting from the use of this coupler which can be found in dollars and cents by any railroad, and that is the cost of the arms paid for; there is a large number of one-armed men in railroad towns at the present time, but they are mostly old or middle-aged men, and the lost members were paid for before the M. C. B. coupler came into general use.

A curious fact was disclosed about a year ago when, upon examination made by a large road using a large per cent of M. C. B. couplers, it was found that the road was buying as many links and pins as it was a year previous to the examination. On another road, the cars of which are all equipped with this coupler, the number of breaks-in-two are only 20 to 25 per cent of the number when the link and pin were universally used and these are generally caused by failure of a link or pin which it has been necessary, for various reasons, to use in

coupling. A road entirely equipped with M. C. B. couplers, made of a recognized high grade material, is buying very few couplers for replacement and its only complaint concerns the interchangeability of knuckles.

**THE RELATIVE RIGHTS AND DUTIES OF EMPLOYERS AND EMPLOYEES TOUCHING APPLIANCES.**

The supreme court of the United States says, in the recent case of the Texas & Pacific Railway Company against Archibald, that it is an elementary rule that it is the duty of the employer to furnish appliances free from defects discoverable by the exercise of ordinary care, and that the employe has a right to rely upon this duty being performed; and that while, in entering the employment, he assumes the ordinary risks incident to the business, he does not assume the risk arising from the neglect of the employer to perform the positive duty owing to the employe with respect to appliances furnished.

An exception to this general rule is well established, which holds that where an employe receives for use a defective appliance, and with knowledge of the defect continues to use it without notice to the employer, he cannot recover for an injury resulting from the defective appliance thus voluntarily and negligently used. But, the court goes on to say, no reason can be found for and no authority exists supporting the contention that an employe, either from his knowledge of the employer's methods of business or from a failure to use ordinary care to ascertain such methods, subjects himself to the risks of appliances being furnished which contain defects that might have been discovered by reasonable inspection.

The employer, on the one hand, may rely on the fact that his employe assumes the risks usually incident to the employment.

The employe, on the other, has the right to rest on the assumption that appliances furnished are free from defects discoverable by proper inspection, and is not submitted to the danger of using appliances containing such defects because of his knowledge of the general methods adopted by the employer in carrying on his business, or because by ordinary care he might have known of the methods, and inferred therefrom that danger of unsafe appliances might arise.

The employe is not compelled to pass judgment on the employer's methods of business, or to conclude as to their adequacy. He has a right to assume that the employer will use reasonable care to make the appliances safe, and to deal with those furnished relying on this fact, subject, of course, to the exception already stated, by which, where an appliance is furnished an employe, in which there exists a defect known to him, or plainly observable by him, he cannot recover for an injury caused by such defective appliance, if, with the knowledge above stated, he negligently continues to use it.

In assuming the risks of the particular service in which he engages, the employe may legally assume that the employer, by whatever rule he elects to conduct his business, will fulfill his legal duty by making reasonable efforts to furnish appliances reasonably safe for the purpose for which they are intended; and, while this does not justify an employe in using an appliance which he knows to be defective, or relieve him from observing patent defects therein, it obviously does not compel him to know or investigate the employer's modes of business, under the penalty, if he does not do so, of taking the risk of the employer's fault in furnishing him unsafe appliances.

**A SCHEME FOR THE RAPID ANALYSIS OF BOILER WATERS FOR SCALE-FORMING INGREDIENTS.**

Mr. Thos. B. Stillman, M. Sc., Ph.D., contributes to the October issue of the Stevens Indicator a brief note on water analysis, as follows:

The complete analysis of a boiler water presents no difficulties to the analytical chemist, but the time required for the various separations and determinations of the constituents, therein, often precludes many examinations. Where the chemical analysis is desired for the amounts of the scale-forming ingredients only, a method should be used that is relatively rapid and approximately correct. A scheme embodying such a method whereby the

amounts of calcium carbonate, calcium sulphate, magnesium carbonate and iron oxide could be rapidly determined, would be of great service in technical laboratories. In many railroad laboratories the following process is used to determine total scale-forming ingredients.

One-half liter of the boiler water is evaporated to dryness in a weighed platinum dish and the amount of residue determined.

This residue is treated with a solution of alcohol 50 parts, and water 50 parts, and then filtered.

The undissolved water is designated as scale-forming material.

This method gives, of course, the total matter that

service. The Union Railway, for which they were built, is a part of the Carnegie system, connecting the Duquense furnaces, Homestead Steel Works, and Edgar Thomson Steel Works, and extends, nominally, from Munhall to North Bessemer, Pa., a distance of about 12 miles. Some four miles of the line has a grade of 70 ft. to the mile, while for about 2000 feet (commencing at the yards near the Edgar Thomson Steel Works, and passing up over the line of the Pennsylvania Railroad, and ending at the foot of the 70 ft. incline), there is a grade of 2 4-10 per cent.

The locomotives are being operated daily upon this line, and steam freely, and, so far, appear not to

**SCHEME FOR RAPID ANALYSIS OF BOILER WATERS.**

Total Solids.	The desired amount of water is evaporated to dryness in a platinum dish and weighed. This residue (1) represents total solids. Ignite, then moisten slightly with distilled water, place in an atmosphere of carbonic acid for half an hour, dry and weigh. This residue (2) is the total mineral matter combined with carbonic acid, as it previously existed, before ignition. The difference in weight between residue (1) and residue (2) is the organic matter.			
Mineral matter.				
Organic matter.				
Scale-forming Ingredients.	Extract soluble matter from residue (2) with successive small portions of distilled water, in all 50 c.c. or less. Filter through ashless filter; dry the residue adhering to platinum dish. Dry and ignite filter and return the matter, it may have retained, to the platinum dish and weigh. The weight of this residue (3), represents the total scale-forming ingredients of the water.			
Non-scale-forming Ingredients.	The filtrate contains the alkalis and magnesia combined with sulphuric acid and chlorine. These may be determined, if desired, but are not necessary in this operation. Their aggregate weight may be determined by subtracting residue (3) from residue (2).			
Treat residue (3) with hot HCl and filter. Wash well.				
RESIDUE. Insoluble mineral matter. Dry, ignite and weigh as such. SiO <sub>2</sub> etc.	FILTRATE. Add ammoniac hydrate in slight excess, boil and filter.			
	RESIDUE. Al <sub>2</sub> O <sub>3</sub> , Fe <sub>2</sub> O <sub>3</sub> Dry, ignite and weigh as such.	FILTRATE. Add solution of ammoniac oxalate in slight excess, set aside ½ hour. Wash with water containing ¼ its volume of ammoniac hydrate.		
		RESIDUE. Dry, ignite and weigh as CaO	FILTRATE. Add solution of sodic phosphate with constant stirring. Set aside ½ hour. Filter. Wash with water containing ¼ its volume of ammoniac hydrate.	
			RESIDUE. Dry, ignite and weigh as Mg <sub>2</sub> P <sub>2</sub> O <sub>7</sub> , and calculate to MgO	FILTRATE. Acidify with HCl, add solution of BaCl <sub>2</sub> in slight excess, boil, set aside ½ hour, filter, wash well with hot water.
				RESIDUE. BaSO <sub>4</sub> , dry, ignite and weigh as BaSO <sub>4</sub> , and calculate to SO <sub>3</sub> . This amount of SO <sub>3</sub> is combined with CaO to form CaSO <sub>4</sub> that exists in residue (3).
SiO <sub>2</sub> etc.	Al <sub>2</sub> O <sub>3</sub> , Fe <sub>2</sub> O <sub>3</sub>	CaO	MgO	SO <sub>3</sub>

\*Communicated to the writer by Prof. Wm. Main, Chemical Expert to New York Filter Co.

is scale-forming, but does not indicate the proportions of each constituent.

It is essential to know, in many cases, whether the scale will be calcium sulphate or calcium carbonate or magnesium carbonate.

The scale formed by calcium sulphate is hard, compact and exceedingly difficult of removal, whereas the scale formed by calcium and magnesium carbonates is more or less porous and not difficult of removal.

A scheme of analysis, that has been used by the author, and showing many advantages for correct determinations with rapidity, is given herewith.

The remaining, CaO, as well as the MgO are calculated to carbonates and the amounts of CaSO<sub>4</sub>, CaCO<sub>3</sub>, MgCO<sub>3</sub>, SiO<sub>2</sub>, etc., and Al<sub>2</sub>O<sub>3</sub>, Fe<sub>2</sub>O<sub>3</sub>, should equal the weight of residue (3). Professor Main states regarding the above scheme, as follows:

"Careful tests made with artificial mixtures of sulphate of lime and carbonate of lime show that the error due to solubility of calcium sulphate, in water, is hardly weighable, especially after it is converted into anhydrous sulphate by heat."

"The amount of sulphate of lime which will fail to precipitate from solution and that which can be dissolved (in any reasonable time) from the solid state, with pure water alone, are very different things. This supposed solubility has previously prevented chemists from using methods similar to the above scheme for a rapid method of boiler-water analysis."

**HEAVY CONSOLIDATION LOCOMOTIVE—UNION RAILWAY.**

The Pittsburgh Locomotive & Car Works has recently delivered two remarkable locomotives to the Union Railway, of Pittsburgh. These are in all probability the two largest locomotives ever built. The general appearance of these large engines is revealed by our photographic view. These engines are of the consolidation type. They weigh 230,000 lbs., of which 208,000 lbs. are on the drivers. They have a total heating surface of 3322 sq. ft., and a grate area of 33.5 sq. ft. The cylinders are 23x32 in. and the drivers are 54 in. in diameter. The engines have a traction power of 53,292 lbs.

These engines were designed for a rather peculiar

be extravagant in the use of fuel and water. We hope, soon, to be given some figures showing fuel and water consumption, and the tonnage hauled on the grades.

The cylinders of these engines are of the half saddle type, made heavy, and have great depth, longitudinally. A steel plate 1 3/8 in. thick, and of the same width as the bottom of the saddle, extends across, and is bolted to the lower frames, and to this plate, as well as to the frames, the cylinders are securely fastened. Heavy bolts passing through the top frame bars, front and back of saddle, form additional transverse ties, and relieve the saddle casting from all tensile strains. The longitudinal strains usually transmitted to the cylinders through the frames are largely absorbed by the use of a casting extended from the hump head well up to the saddle, securely bolted to the top and the bottom front frame. This casting also acts as a guide for the bolster pin of the truck. This method of relieving cylinders of longitudinal stress was introduced by the Pittsburgh Locomotive Works nearly two years ago, and has proven, in practical use, on a large number of locomotives, to be of great value in reducing breakage of saddle castings. The frames are 4 1/2 in. wide and have been cut from rolled steel slabs made by the Carnegie Steel Co. and weigh 17,160 lbs. per pair, finished.

The builders hope to have, later, side and end elevations which will clearly show the design and proportions of these locomotives, and explain how they have been able to design a locomotive of such great weight without adding "fat" or unnecessary chunks of cast iron, or other material, to bring the locomotive up to required weight.

Appended are the leading details of these engines: GENERAL DESCRIPTION.

Type	Consolidation.
Name of builder	Pittsburgh Locomotive Works.
Name of operating road	Union Railroad.
Gage	4 ft. 8 1/2 in.
Kind of fuel to be used	Bituminous coal.
Weight on drivers	208,000 lbs.
Weight on truck wheels	22,000 lbs.
Weight, total	230,000 lbs.
Weight of tender, loaded	104,000 lbs.
Weight, total of engine and tender	334,000 lbs.
Traction power	53,292 lbs.
DIMENSIONS.	
Wheel base, total, of engine	24 ft. 0 in.

Wheel base, driving.....	15 ft. 7 in.
Wheel base, total (engine and tender)...	54 ft. 9 1/2 in.
Length over all, engine.....	39 ft. 8 1/4 in.
Length over all, total, engine and tender.	65 ft. 3 1/2 in.
Height, center of boiler above rails.....	9 ft. 3 3/8 in.
Height of stack above rails.....	15 ft. 6 in.
Heating surface, fire-box.....	205.5 sq. ft.
Heating surface, tubes.....	3116.5 sq. ft.
Heating surface, total.....	3322 sq. ft.
Grate area.....	33.5 sq. ft.

WHEELS AND JOURNALS.

Drivers, number.....	Eight.
Drivers, diameter.....	54 in.
Drivers, material of centers.....	Steeled cast iron.
Drivers, material main centers.....	Cast steel.
Truck wheels, diameter.....	30 in.

Fire-box, depth, front.....	76 3/4 in.
Fire-box, depth, back.....	69 7-16 in.
Fire-box material.....	Carnegie fire-box steel.
Fire-box, thickness of sheets, crown.....	7-16 in.
Fire-box, thickness of sheets, sides and back...	3/8 in.
Fire-box, thickness of sheets, tube.....	1/2 in.
Fire-box, brick arch.....	Supported on studs.
Fire-box water space, width.....	.....
.....Front 4 in., sides 4 in., back 4 in.	.....
Grates.....	Cast iron, rocking pattern.

SMOKEBOX.

Smokebox, diameter.....	83 1/4 in.
Smokebox, length from tube sheet to end.....	68 3/8 in.

OTHER PARTS.

Exhaust nozzle.....	Single.
Exhaust nozzle, diameter.....	5 3/4 in.

5. Air Brake Appliances; to propose complete standards, including piping, with a view to reducing the joints to a minimum—A. L. Humphrey, A. M. Parent, H. C. McCarty.

6. Ladders and Running Boards—A. E. Mitchell, P. H. Peck, S. Higgins.

7. Wheels and axles; specifications for wheels and axles for 60,000, 80,000 and 100,000 pound cars—E. D. Nelson, D. Leeds, Wm. Garstang.

8. Uniformity of Section for Car Sills; to consider the practicability of adopting a standard—R. P. C. Sanderson, J. S. Lentz, N. Frey.

9. Heights of Couplers; to confer with the American Railway Association and with the Inter State Commerce Commission if necessary—Saml. Higgins, chairman; J. H. McConnell, C. M. Mendenhall.



HEAVY CONSOLIDATION LOCOMOTIVE—UNION RAILWAY.

Journals, driving axle, size.....	9x12 in.
Journals, truck axle, size.....	6x10 in.
Main crank pin, size.....	7x7 in.

CYLINDERS.

Cylinders, diameter.....	23 in.
Piston, stroke.....	32 in.
Piston rod, diameter.....	4 1/2 in.
Piston and valve stem packing.....	Metallic.
Main rod, length center to center.....	9 ft. 10 1/2 in.
Steam ports, length.....	20 in.
Steam ports, width.....	1 1/8 in.
Exhaust ports, length.....	20 in.
Exhaust ports, width.....	3 1/4 in.
Bridge, width.....	1 1/2 in.
Cylinders and valves oiled by sight feed lubricator.	.....

VALVES.

Valves.....	Balanced.
Valves, greatest travel.....	6 in.
Valves, outside lap.....	1 in.
Valves, inside lap or clearance.....	0 in.
Valves, lead in full gear.....	1-16 in.

BOILER.

Boiler, type of.....	Straight with sloping back end.
Boiler, water test.....	300 lbs.
Boiler, steam test.....	220 lbs.
Boiler, working pressure.....	200 lbs.
Boiler, material in barrel.....	Carnegie steel.
Boiler, thickness of material in barrel.....	7/8 in.
Boiler, diameter of barrel at front sheet.....	60 in.
Boiler, diameter of barrel at throat sheet.....	83 1/2 in.
Boiler, diameter of barrel at back head.....	74 5/8 in.
Seams, kind of.....	Horizontal, butt joint, double welded and sextuple riveted.
Seams, kind of, circumferential.....	Double riveted.
Thickness of tube sheets.....	5/8 in.
Crown sheet supported by stays.....	1 1/8 in. diameter.
Dome, diameter.....	32 in.
Safety valves, two 3 in. open pops and one 3 in. muffler.	.....
Water supplied through.....	Two No. 11 injectors.

TUBES.

Tubes, number.....	355
Tubes, material.....	Knobbed charcoal iron.
Tubes, outside diameter.....	2 1/4 in.
Tubes, length over sheets.....	15 ft. 0 in.

FIRE-BOX.

Fire-box, length.....	10 ft. 0 in.
Fire-box, width.....	3 ft. 4 1/4 in.

Exhaust nozzle, distance of tip below center of boiler.....	5 5/8 in.
Netting, size of mesh.....	2x2 in.
Stack.....	Taper.
Stack, least diameter.....	17 in.
Stack, greatest diameter.....	18 in.
Stack, height above smokebox.....	2 ft. 9 in.
Track sander.....	Pneumatic
Power brake.....	Westinghouse-American.

TENDER.

Type.....	With swivel trucks.
Tank capacity, water.....	5,000 gallons.
Tank capacity, coal.....	10 tons.
Kind of material in tank.....	Carnegie steel.
Thickness of tank sheets.....	1/4 in. and 5-16 in.
Type of under-frame.....	Steel channels.
Type of truck.....	Diamond.
Truck with rigid bolster.....	.....
Type of truck springs.....	Double Elliptic.
Diameter of truck wheels.....	33 in.
Diameter and length of axle journals.....	5x9 in.
Distance between centers of journals.....	76 in.
Diameter of wheel fit on axle.....	63/8 in.
Diameter of center of axle.....	5 3/8 in.
Length of tender frame over bumpers.....	22 ft. 11 1/4 in.
Length of tank.....	20 ft. 6 in.
Width of tank.....	9 ft. 8 in.
Height of tank, not including collar.....	56 in.
Height of tank over collar.....	68 in.
Type of back drawhead.....	M. C. B. Coupler.

MASTER CAR BUILDERS' COMMITTEES FOR 1899.

The subjects and committees for the next year's work in the Master Car Builders' Association have been chosen and are as follows:

1. Trains Parting—G. N. Dow, J. M. Holt, D. Hawksworth, Jno. Hodge.
2. Square Bolt Heads and Nuts—B. Haskell, W. H. Lewis, Thos. Fildes.
3. Should any additional compensation be paid for car repairs done west of the 150th meridian—J. N. Barr, S. P. Bush, J. H. McConnell, L. C. Haynes, T. B. Kirby.
4. M. C. B. Couplers; to define contour lines more fully, when new and when worn, and propose specifications for couplers—W. W. Atterbury, W. P. Appleyard, W. S. Morris.

10. Subjects—G. L. Potter, J. J. Hennessey, R. P. C. Sanderson.

The standing committees are as follows:

On Arbitration—G. W. Rhodes, chairman; John McKenzie, G. L. Potter, M. M. Martin, J. N. Barr.

On Supervision of Standards and Recommended Practice of the Association—A. M. Waitt, chairman; G. L. Potter, Wm. Apps.

On Triple Valve Tests—G. W. Rhodes, chairman; A. W. Gibbs, W. S. Morris.

On Standard Wheel and Track Gauges—To confer with American Railway Association—J. N. Barr, chairman; G. W. Rhodes, C. M. Mendenhall, G. L. Potter.

On Brake Shoe Tests—S. P. Bush, chairman; Geo. Gibbs, R. P. C. Sanderson.

On Prics in Master Car Builders' Rules; to report what changes may be desirable—J. N. Barr, chairman; S. P. Bush, S. A. Charpiot, J. H. McConnell, T. B. Purves, Jr.

A great deal has been done, in designing sleeping car equipment, in the way of providing for the comfort of men. Special attention has been given to their toilet rooms and to their smoking compartments in the sleepers, and they have been given, on many roads, separate cars for their special use, fitted with libraries, buffets, barber shops, bath rooms, stenographers' desks, etc. This has always seemed to us rather one-sided, and we are pleased to note that the Baltimore & Ohio, for one, is paying more attention to the women. This company, some time ago, had built, by the Pullman Palace Car Company, three parlor cars for its New York trains, and the radical departure from other cars of this character lay in the toilet room for ladies, which was eight feet in length. Recently the same company has had built eight new sleepers for the New York-St. Louis line, and the designer of these cars has evidently been impelled by the popularity of the ladies' retiring room in the parlor cars to give to the ladies a vast deal more space than they ever had before in sleeping cars. These new cars are said by the Pullman people to be the finest they ever turned out, and the ladies' retiring room is

exceedingly commodious, and contains, besides other toilet necessities, a dresser with a long pier glass. These cars, we may add, are finished in vermilion wood decorated with inlaid marquetry work, and the upholstery on the backs and seats is entirely new and different from any heretofore used, being a sort of a moquette with a dark green border and a center pattern of bright color. A similar design of ornamentation has been applied to the ceiling, giving the car an arabesque effect. They are also supplied with all the modern appliances, such as wide vestibules, the anti-telescoping device, and the air pressure water system, and are lighted with Pintsch gas. A very pleasing effect is obtained by the oval windows of opalescent glass, the first, it is asserted, that have been used in the construction of sleeping cars.

**CONSOLIDATION LOCOMOTIVE—CHESAPEAKE & OHIO RAILWAY.**

Much interest has been expressed in the new consolidation locomotive for mountain service, which has been designed recently by Mr. W. S. Morris, superintendent of motive power of the Chesapeake and Ohio Railway, and which is being built by the Richmond Locomotive & Machine Works, and no doubt the illustration of, and information concerning, the locomotives here given will be duly appreciated. It will be noted that the machine is quite a powerful one, having cylinders 22 ins. in diameter with a stroke of piston of 28 ins., a boiler 70 ins. in diameter at first ring, and driving wheels 56 ins. diameter over new tires; and that it is quite heavy, its weight on drivers being 165,000 lbs., and total weight 184,000 lbs. But quite as interesting is the fact that Mr. Morris has designed a simple engine for this service. We are not advised of the motive; but it may be that the simple type is chosen for the reason that it is beginning to be felt that compounds do not work to the best advantage in districts allowing much "drifting;" as we set forth editorially in our issue of September, 1898, page 119.

The illustrations will indicate that the general design is abreast of thoroughly modern practice; the outline is very symmetrical and the parts which should be accessible are conveniently arranged. The extent to which, what may be called, "special material," is used is always of interest when a new design of locomotive is produced and the one under consideration shows a very conservative use of such material. The piston rods and axles are of Coffin process steel; the eccentric straps are of phosphor bronze; the driving boxes are of cast steel, with tin facing on the side adjacent to wheel hub; the main crank pins are of nickel steel and the others are of either nickel steel or of Coffin toughened process steel. The tender frame is metal construction.

The cross section of the piston, shown on the side elevation, indicates an appreciation of the necessity of making the reciprocating parts as light as possible and, considering the diameter of the pistons, they are well below the average in weight. Concerning the design of radial stay, shown in the section through the firebox, we will only direct attention to it in this issue and hope to show it more in detail in another issue; its design in general will be understood from the present illustration and its function will be understood to be to prevent any downward motion of the crown sheet and to provide for a little upward motion of the sheet to prevent cramping when the fire is being kindled.

The boiler is of the extended wagon-top type and designed to carry 200 lbs. pressure per square inch.; to be tested with steam pressure at 25 per cent, and with water 40 per cent, above working pressure. The barrel is of sheets  $\frac{3}{4}$  and 1 3-16 in. thick, riveted with 1-in. rivets; the longitudinal seams being sextuple riveted, with welt strips inside and out; the circumferential seams are double riveted.

Some of the principal data for these locomotives are as follows:

- Cylinders.....22 ins. diameter, 28 ins. stroke.
- Driving wheels, diameter.....56 ins.
- Driving wheels, base.....17 ft.
- Diameter boiler, first ring.....70 ins.
- Number of tubes.....347
- Diameter of tubes.....2 ins.
- Length of tubes.....14 ft. 2 1/2 ins.
- Heating surface, tubes.....2566 sq. ft.
- Heating surface, firebox.....239 sq. ft.
- Heating surface, total.....2805 sq. ft.

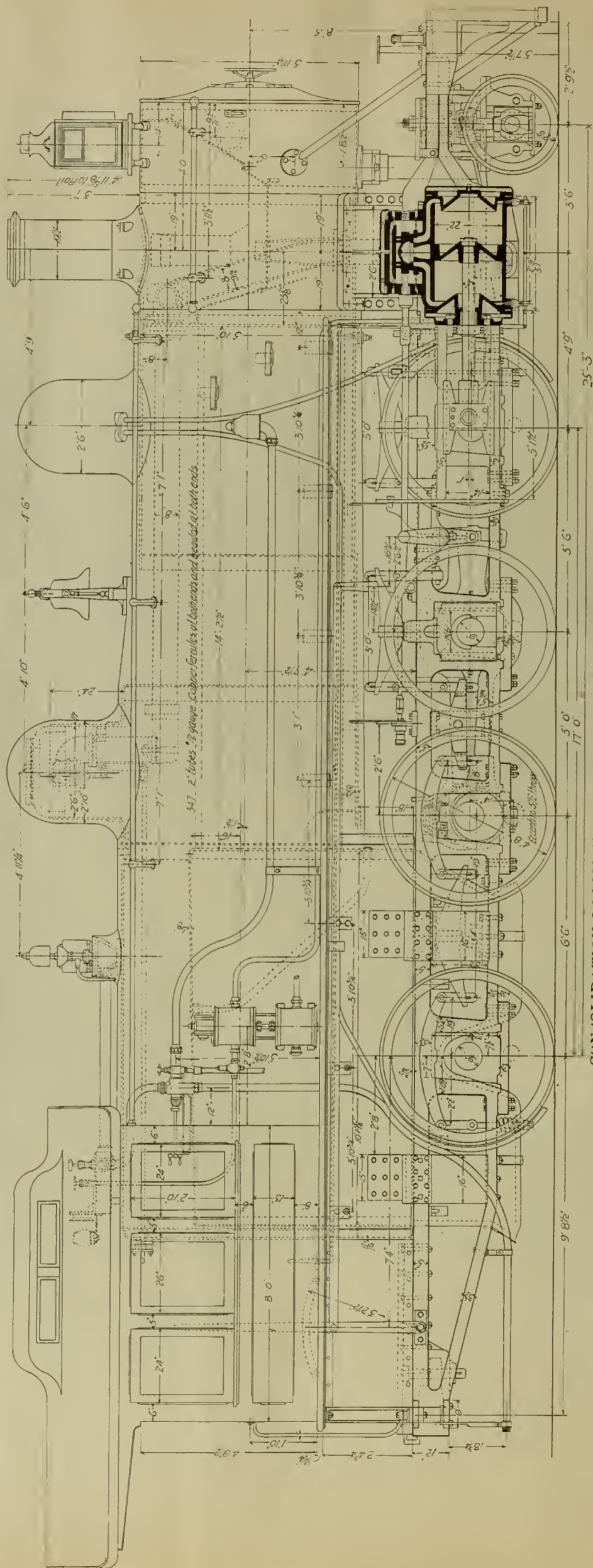

**CONSOLIDATION LOCOMOTIVE—CHESAPEAKE & OHIO RAILWAY.**

try over, has, during the summer, been supplemented by the addition of a room 50x100 feet, known as the Railroad Laboratory. In this room the equipment of machines for testing strength of materials, and the brake shoe testing machine of the Master Car Builders' Association, are already in place. There is also a fine full-sized model of the front end of a Richmond compound locomotive and an exhibit of typical steel car trucks. The equipment of this room is being completed

Purdue University entered upon the work of a new term on Sept. 14th under conditions favorable to an excellent year's work. The Engineering Laboratory, so well known to engineers the coun-

besides that mentioned above, is as specified:  
 Stay bolts, Tennessee bloom or Taylor iron.  
 Rivets, Burden iron  
 Packing, Jerome, piston rod, valve stem and air pumps.  
 Tires, driving, Latrobe or Midvale.  
 Tires, truck, Latrobe, Midvale or Standard.  
 Injector, Monitor No. 10.  
 Truck wheel, steel tired; Boise, McKee-Fuller or Standard  
 Boiler lagging, 85 per cent magnesia.

- Grate area.....35.15 sq. ft.
  - Firebox, length inside.....121 1/2 ins.
  - Firebox, width inside.....41 1/2 ins.
  - Steam pressure.....200 lbs.
  - Weight on drivers.....165,000 lbs.
  - Weight on truck.....19,000 lbs.
  - Weight, total of engine.....184,000 lbs.
  - Tank capacity, water.....4500 gal.
  - Tank capacity, coal.....7 tons.
- The pilot and tender are equipped with the M. C. B. automatic coupler. Some of the special equipment,

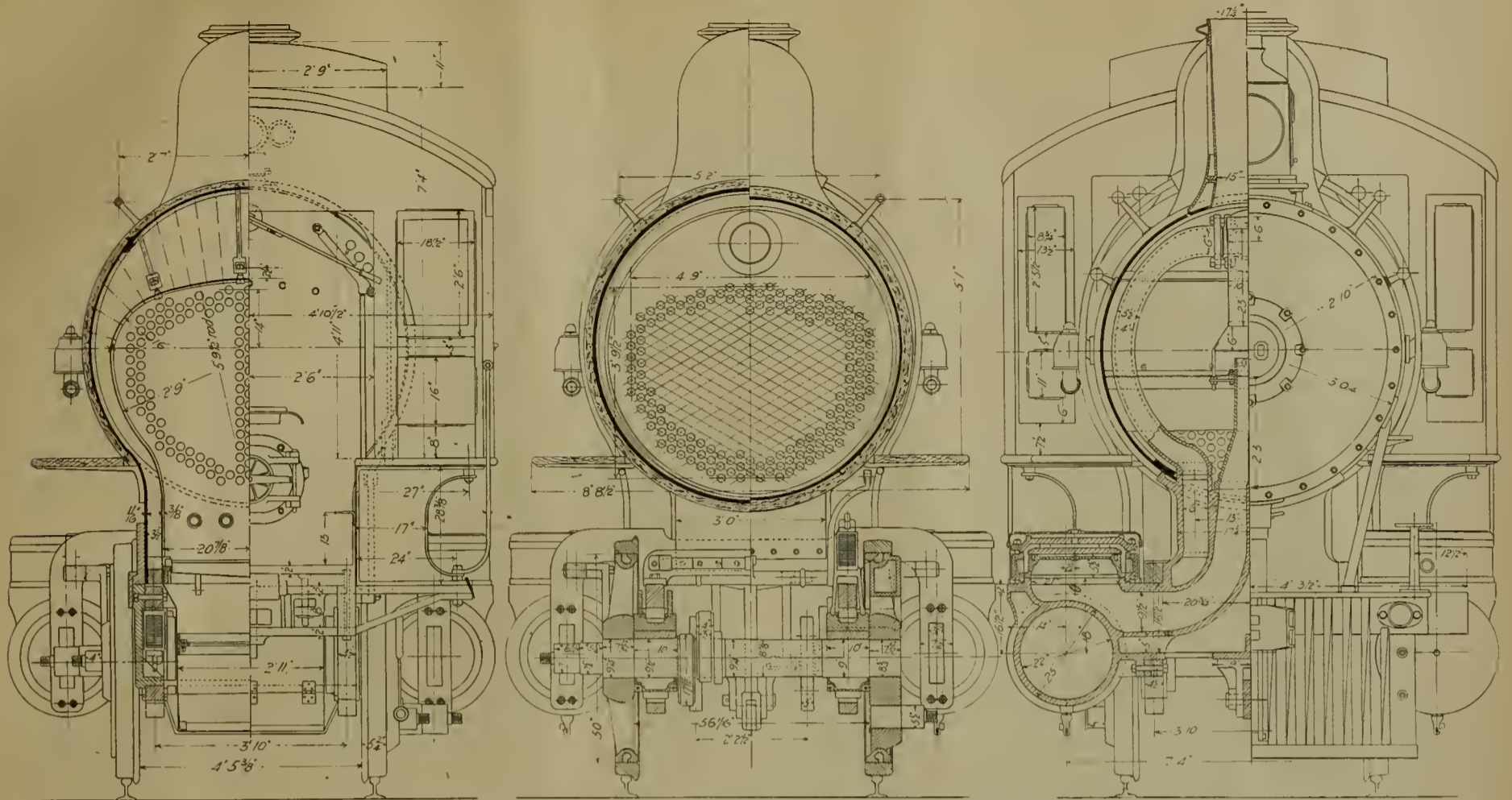

CONSOLIDATION LOCOMOTIVE—CHESAPEAKE & OHIO RY.—CROSS SECTIONS.

by the installation of the air brake testing rack of the Master Car Builders' Association. There are but few changes in the corps of instructors in the engineering department. Mr. Leopold O. Dahse, for several years Senior Instructor in Mechanical Engineering, Lehigh University, has been appointed an instructor in Machine Design, and Mr. Robert S. Miller, assistant in the Engineering Laboratory, has been made instructor in the Mechanics of Machinery.

COMMUNICATIONS.

The M. C. B. Coupler.

Louisville, Ky., Sept. 7, 1898.

To the Editor of the Railway Master Mechanic:

Your September issue is to hand, as also issues of other papers, which claim to give the paper written by

me, and read before the Central Association of Railroad Officers, on the Master Car Builders' coupler; and to each and every one of them I want to put in a protest under the heading of the "truth half told, etc." Any one reading these papers would think that I had come forward to attack the M. C. B. coupler voluntarily. In your paper you say that "the queries with which I head my paper, etc." If the paper as presented had been printed in full everybody would have understood that it had been presented to that association at their request, or rather at the request of one of the divisions of the association, and that it was not a gratuitous attack on my part, but simply the fulfillment of what I considered a duty to the division of the association to which I belong. The queries are not mine but those of a committee that was appointed to suggest subjects on which papers should be written; they not only stated the subject under the heading of these queries, just as they are given, but rather demanded that I should write the paper, and having the endorsement of the division I wrote it, and explained my reasons for writing it.

I have nothing to rescind in statements that I have made in that paper, and can add considerable testimony that, in my opinion, is conclusive, that the vertical plane coupler was hastily and improvidently adopted without proper effort having been made to make the link and pin coupler automatic. In the meeting of the central association this statement was questioned to some extent, by one party stating that there had been a great number of automatic link and pin couplers patented. He did not take the pains to say that they had been patented almost exclusively since the adoption of the vertical plane coupler. Besides this, out of the great number of automatic link and pin couplers patented there is probably as great a proportion of them that are not efficient and practicable as there are of the great number of vertical plane couplers that have been patented. As I understand it there are some nine thousand patents on automatic drawbars or couplers. I think it is safe to say that not only are a great majority of these vertical plane, but almost the entire number. Out of these I understand that at one of the most important points of interchange their record shows only seventy-three of them that have been considered of value enough to be adopted, and the probabilities are that if a committee was appointed for the purpose of passing upon the seventy-three there would be but very few of them survive.

Another thing in this connection, if the standard height of drawbars had been as fully established previous to 1890 as it has been since, or is now, the link and pin would have had a great deal better show of becoming the automatic drawbar, instead of the vertical plane.

I simply reiterate the assertion that in all mechanical lines the link and pin is the most efficient method of coupling cars, and outside of the mere matter of coupling has less defects than any other method that has been adopted, and I believe it would have been practicable to have made this point of coupling as fully efficient as the method now adopted; and if this had been accomplished we would have retained all the essentials that I have enumerated in the paper referred to.

P. Leeds, S. M., L. & N. Ry.

RELATIVE FREQUENCY OF KNUCKLE BREAKAGES.

Through the courtesy of the McConway & Torley Company we are permitted to publish this table, showing percentages of knuckle breakages for the terms indicated

Term ending March 31.	1891.	1892.	1893.	1894.	1895.	1896.	1897.	1898.
Upper lug off.....	31.52	27.59	26.71	26.92	25.78	24.79	24.30	23.82
Upper lug cracked.....	10.44	19.08	22.10	23.13	24.76	25.10	26.20	27.84
Upper lug chipped.....	21.84	19.86	18.58	17.10	17.91	18.61	18.68	18.19
Lower lug off.....	6.50	5.29	5.24	5.14	4.75	4.22	3.76	3.30
Lower lug cracked.....	2.21	2.90	2.63	2.23	1.91	2.14	2.31	2.36
Lower lug chipped.....	2.52	2.13	1.93	1.63	1.60	1.70	1.73	1.71
Both lugs off.....	7.73	8.04	7.98	8.85	8.03	7.44	7.00	6.55
Both lugs cracked.....	0.47	0.31	0.23	0.22	0.21	0.19	0.17	0.15
Both lugs chipped.....	6.31	3.52	2.64	2.15	2.15	2.50	2.57	2.49
Upper lug off.....	0.92	0.95	0.93	0.93	0.78	0.63	0.54	0.46
Lower lug cracked.....	0.36	0.32	0.27	0.26	0.23	0.22	0.19	0.16
Upper lug cracked.....	3.15	2.19	1.89	1.78	1.46	1.24	1.06	0.91
Lower lug chipped.....	3.41	2.31	1.94	1.72	1.43	1.15	0.95	0.89
Tail off.....	0.93	0.77	0.74	0.74	0.75	0.87	1.00	1.18
Worn out (passenger).....	1.17	3.80	4.87	6.09	7.47	7.08	6.93	7.11
No defects observed.....	0.21	0.57	1.08	0.96	0.68	2.05	2.54	2.91
Miscellaneous.....	0.31	0.37	0.24	0.15	0.10	0.07	0.07	0.06
Total.....	100.00	100.00	100.00	100.00	100.00	100.00	100.00	100.00

Danger to Engineers.

136 Richmond Ave., Buffalo, N. Y., Oct. 30, 1898.  
To the Editor of the Railway Master Mechanic.

The enclosed newspaper slip gives an account which, when stripped of the reporter's attempts at fine writing, shows how near a passenger train came to being wrecked by the accidental death of its engineer, the engine being one which necessitates the engineer and fireman being at a considerable distance apart. It emphasizes a conclusion easily reached when the uncertainties of business life are taken into consideration, that no locomotive engineer should be alone, or cut off from observation, when in the performance of his duties. It would be better if some one were employed to ride

with him, on engines of such construction as to involve his separation from the fireman. At least, in such cases, the rear of the cab should be almost entirely composed of glass, to allow the fireman, standing at the rear of the engine, to keep him always in sight.

It is not many years since one of the Erie engineers was found to be insensible on the arrival of the train at Deposit, his face being badly burned by contact with the boiler. This was, if the writer remembers aright, the consequence of an apoplectic fit. There is another instance of the engineer of a passenger train on the New York Central Railroad dying suddenly while his engine was running. Geo. B. Snow.

[The substance of the dispatch referred to above was: "Susquehanna, Oct. 27.—With the engineer, Henry Kinsley, stretched dead in his cab, the Erie night express train, No. 12, carrying 200 passengers, ran wild 20 miles in 20 minutes early Tuesday morn-

NEW SHOPS OF THE C. H. & D. RAILWAY.

The Cincinnati, Hamilton & Dayton Railway recently completed a group of new car shops at its Lima headquarters, from the designs of its Superintendent of Motive Power, Mr. C. H. Cory. We present herewith a ground plan of these shops, together with that of the old buildings. We also give a floor plan of the machine and wood-working shop, showing the location of tools, and in addition a perspective sketch of the entire plant. In this latter sketch the old and new groups of buildings are arbitrarily brought close together for the convenience of illustration. They are in reality, widely separated, as our ground plan shows

Building No. 1 is the supply store house. This

passenger car paint shop, is a duplicate of No. 4, but has a cement floor. Building No. 6, the freight car repair and erecting shop, covers an area of 29,776 sq. ft. Building No. 7 is the paint mixing shop, and in this shop all painters' tools and supplies are stored over night, to keep them out of the paint shop. This building has a cement floor and covers an area of 1,800 sq. ft. No. 8, the upholstery shop, is a duplicate of No. 7, with the exception of the cement floor. All the new buildings are covered with slate roof.

Lying between these shops, as shown, is a transfer table pit 411 ft. long and 65 ft. wide, over which operates an electric transfer table. All these buildings, as well as the old buildings, have been completely fitted out with air piping, and air is very

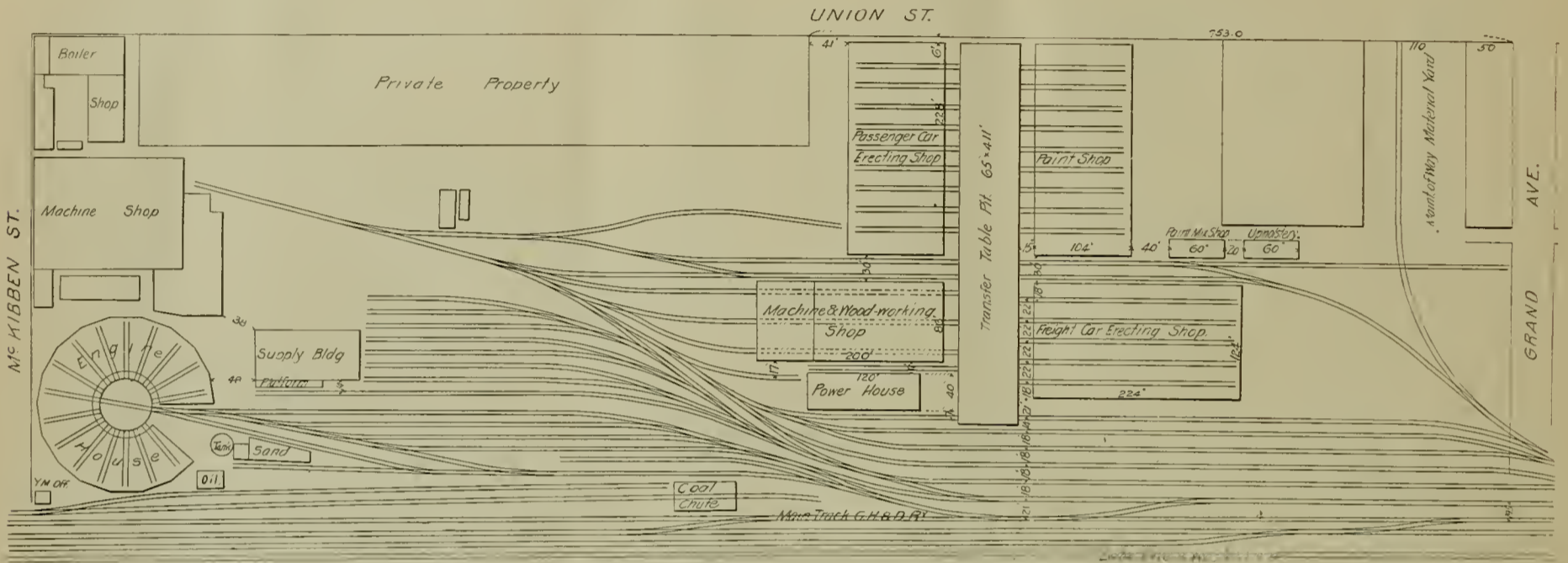

NEW SHOPS OF THE CINCINNATI, HAMILTON & DAYTON RAILWAY.

ing. Kinsley, one of the most careful and reliable of engineers, had leaned too far from his cab window and dashed out his brains against the ironwork of a bridge. \* \* \* In the 20 minutes fraught with such perils to 200 creatures, Kinsley's fireman, Cowgill, of Hornellsville, as well as the most accustomed travelers in the coaches, became aware that the locomotive whistle was silent. It did not sound even when the train was approaching the station here. Cowgill, frightened—

building, like all the other buildings of the new group, is built of steel structural work, the sides and ends being filled in with brick. The store or supply house covers an area of 6250 sq. ft. Building No. 2 is the wood working and machine shop, and covers an area of 17,200 sq. ft. Building No. 3 is the power house, which is built of brick, and covers an area of 4800 sq. ft. It contains one 300 n.

extensively used in a wide range of shop operations. In the old group of buildings A is the boiler shop, which covers an area of 5480 sq. ft.; B is the machine shop, covering an area of 18,000 sq. ft.; C, the blacksmith shop, covering an area of 6500 sq. ft., and D, the engine house, containing 16 stalls. It will be noted that these shops and grounds are very completely served with an elaborate track system.

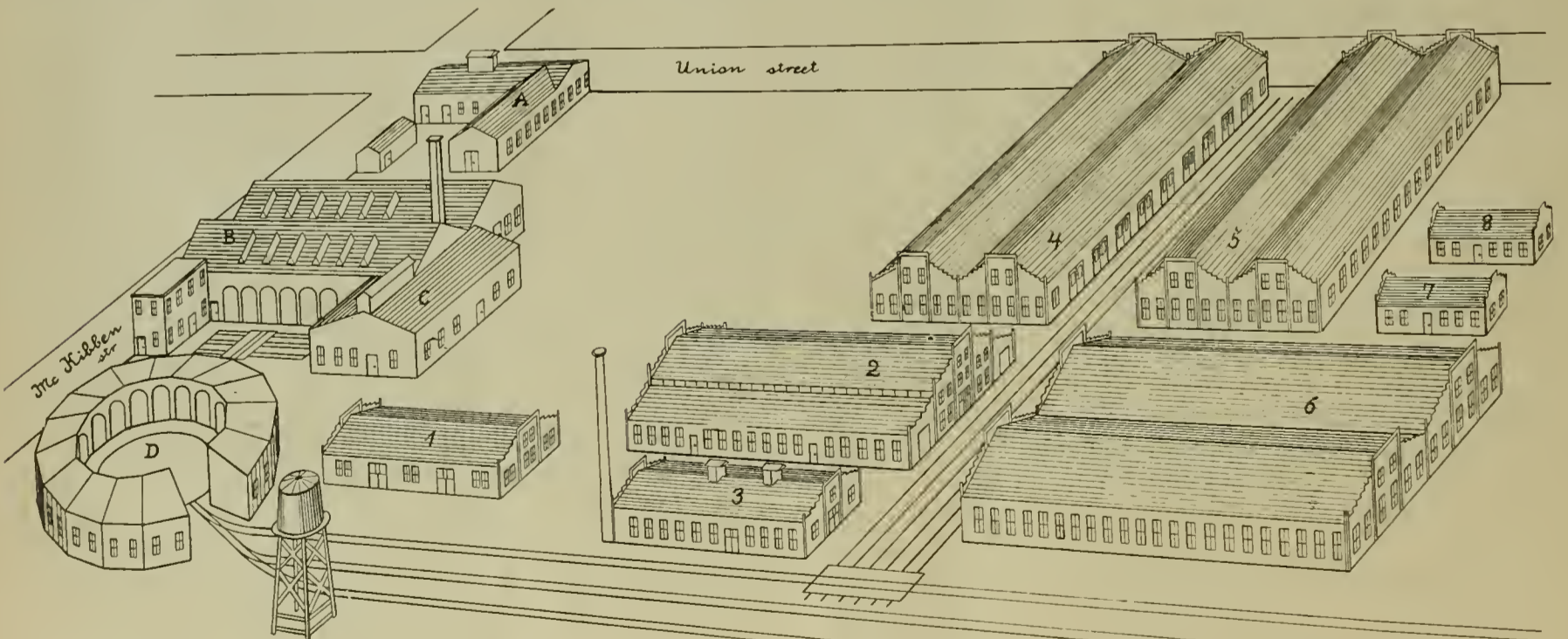

NEW SHOPS OF THE CINCINNATI, HAMILTON & DAYTON RAILWAY.

for he knew not what might happen if the train flew through Susquehanna—made his perilous way over the tank at the rear of the engine to the cab. The cab door was fastened. Cowgill forced it open and entered. The engineer lay dead before him. The fireman, with thought for the living first in his mind, shut off steam as suddenly as he dared and the wild run ended at this station.”]

p. Corliss engine, two 230 h. p. boilers, one air compressor capable of producing 600 cu. ft. of free air per minute, one hot air blower to furnish heat for the new group of buildings, a steam heater and water purifier, and an electric light plant. Building No. 4 is the passenger car erecting shop and covers an area of 23,712 sq. ft. Building No. 5, the

The power station was planned with due regard for the most thorough economy of operation. The boilers are fitted with the Hawley down draft furnace and are supplied with hot feed water from a Cochrane special heater and receiver, which is of the open heater type and fitted with a separator



for purifying the exhaust steam. Such of the exhaust steam as is not used in heating the feed water is conveyed to the coils intended to heat the air for warming the buildings, the supply for this purpose being supplemented by live steam direct from the boilers when the exhaust proves inadequate.

The wood-working shop is roomy and well lighted. All of the machinery is brand new and of the latest designs of Messrs. J. A. Fay & Co. of Cin-

injured, 6,283. The corresponding figures for the year ending June 30, 1896, were 229 killed and 8,457 injured. The casualties from coupling and uncoupling cars were assigned as follows: Train men, killed, 147; injured, 4698; switchmen, flagmen, and watchmen, killed, 58; injured, 1325; other employees, killed, 9; injured, 260. The casualties resulting from falling from trains and engines were as follows: Train men, killed, 325; injured, 2726; switchmen,

ern engines, and have also been successfully tested on the Chicago, Rock Island & Pacific, Illinois Central, Minneapolis & St. Louis, Chicago, Burlington & Quincy Chicago, Milwaukee & St. Paul, and other roads. This appliance has been patented by Mr. Williams.

Riveting by Electricity.\*

For the last two years I have been experimenting on electric riveting machines, and have finally succeeded in bringing out a type of riveting machine quite capable of superseding the two systems already existing, viz., hydraulic and pneumatic riveting. There are a good many firms in this country who have to decide which system of riveting they intend to adopt for the future. In order to keep pace with the rapidly increasing competition of other firms at home and abroad, and this is the reason that I propose to read a paper on this subject at the present meeting; especially as I have seen that some firms on the other side of the Atlantic are making great efforts to introduce the pneumatic system, and promise gigantic profits to those who decide to adopt it. The machine I am describing has closed for weeks and weeks 1200 rivets in a day of ten hours' duration, requiring the attendance of only three men and a boy.

The electric riveting machines which have up to the present been built can be carried about easily to any place in the yard, but are not made for being suspended from a crane. To the large jaw are attached two platforms at right angles, so that the riveter may be used horizontally or vertically. The system is so very simple that I need not occupy much of your time in describing it. One heavy disk is always rotating by electricity, whether the riveter is closing rivets or not. This disk can become, at the same time, an electro-magnetic coupling, so that when the current is passing this coupling a second disk, keyed on to a screw spindle, may be at once firmly attached to the revolving disk, thus the friction of the screw spindle can be regulated according to the operator's wish. The screw spindle moves a large nut at the end of the knuckle joint, which raises and lowers the die for making the rivet head. Between the two already-mentioned disks a conical friction roller can be inserted. By pressing in this roller, the motion of the screw spindle can be reversed, and the nut of the knuckle joint returned to its original position in order to be ready for a new stroke.

The pressure on the die must be regulated in proportion to the diameter of the rivet, and this is done by producing more or less friction between the two disks, which difference in friction is obtained by more or less current being admitted to the electro-magnetic coupling.

The type of the riveting machine which we are building now is made chiefly for shipbuilding purposes, and closes rivets up to 1 3/4 inch in diameter; the output is, as already stated, 120 rivets per hour. When so many hot rivets are required in a short time, the question of heating the rivets becomes very important. When we started to rivet by electricity, we could not produce the number of hot rivets required by using a reasonable number of portable forges. For this reason we have made a small fan, driven by an electric motor, to supply air to a number of small furnaces, which considerably reduces the number of boys required for heating rivets.

A NEW BALLAST UNLOADER—NORTHERN PACIFIC RAILWAY.

On the Northern Pacific Railroad there has been designed and placed in use a ballast unloader which possesses some novel and very valuable features. It was designed by Mr. H. H. Warner, Master Mechanic at the Tacoma shops of that road, and has been patented by him. Its general appearance and the principles upon which it is constructed are thoroughly shown in the accompanying engravings.

The ordinary ballast unloading plow is, as is well known, rather expensive to operate and maintain, and is, moreover, liable to injure the car. Those of the class in which the plow works on a longitudinal center timber guide are not capable of dumping or unloading material at one side of the car only, as is frequently necessary or very desirable in railroad work. Moreover, this timber guide, if of sufficient size to keep the plow in position and to prevent it from jumping off the car, adds to the cost and dead weight of the car, and occupies a considerable space which would otherwise be available for ballast or other loads. In other designs, where the plow is guided by stakes on the cars, it is ob-

\*From a paper by F. von Kodolitsch, read before the Institution of Naval Architects, England.

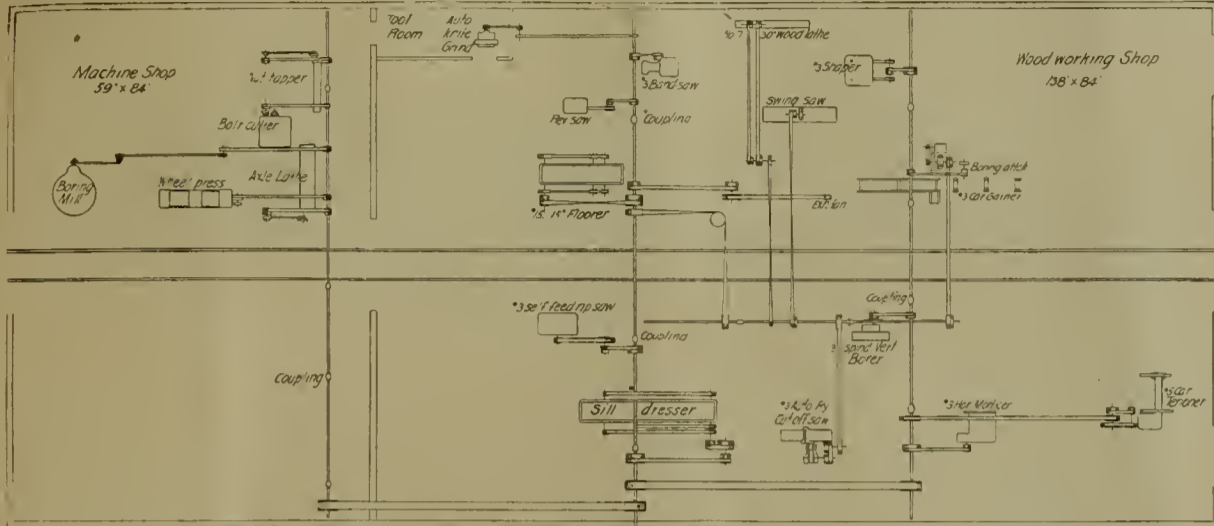

NEW SHOPS OF THE CINCINNATI, HAMILTON & DAYTON RAILWAY.

ciunati. The most modern practice for facilitating the preparation of material for car construction is represented in the department. The machine shop end of this building contains all necessary machinery for preparing car wheels for service, work which has, heretofore, been done in the machine shop of the locomotive department. The wood working shop is provided with a very complete shavings conveyor system which carries all waste products from the various machines direct to the boiler furnaces, or stores them in a vault designed for the purpose, at the will of the fireman. A considerable saving in fuel is thus affected.

The entire grounds and buildings have been provided with an ingenious watchman's check system of the pneumatic type with stations located in such a manner as to insure a thorough traversing of every portion of the property during each round of the watchman, thus reducing the danger from fires and thieves, to a minimum.

The Lima shops had, up to the first of this year, built twenty-eight passenger and freight engines and five switching engines, ten baggage and three mail and express cars. They had been rebuilding per month on an average, fifty freight cars and putting heavy repairs onto an average of 100 cars, and light repairs on an average of 290 cars per month. They had been doing general heavy repairs to an average of six locomotives per month and light repairs to fifteen to twenty locomotives during the same period. With the completion of the new buildings, which were erected to replace structures destroyed by fire late in 1896, the facilities and capacity of the plant were materially increased.

A comparative summary is presented in the report of the interstate commerce commission's statistician of the average daily compensation of the different classes of employees for the years 1892 to 1897. Another summary is given in the report which shows the total amount of compensation reported as paid to railway employees during the fiscal years 1895 to 1897. It covers the compensation of over 99 per cent of railway employees for the several years. Regarding the year ending June 30, 1897, it appears that the aggregate amount of wages and salaries paid was \$465,601,581. This amount represents 61.87 per cent of the total operating expenses of railways, or \$2,540 per mile of line. The total compensation for 1896 was \$3,222,950 greater.

The total number of casualties to persons on account of railway accidents for the year ending June 30, 1897, was 43,168. Of these casualties 6,437 resulted in death, and 36,731 in injuries of varying character. Of railway employees, 1,693 were killed and 27,667 were injured during the year. According to the three general classes these casualties were divided as follows: Train men, 976 killed, 13,795 injured; switchmen, flagmen, and watchmen, 201 killed, 2,423 injured; other employees, 516 killed, 11,449 injured. The casualties to employees resulting from coupling and uncoupling cars were, killed, 214;

flagmen, and watchmen, killed, 32; injured, 357; other employees, killed, 51; injured, 544.

COMBINATION CLINKER TONGS.

At the last meeting of the Western Railway Club, Mr. W. H. Marshall, assistant superintendent of motive power, of the Chicago & Northwestern Ry. stated, during the discussion on long locomotive runs, that excellent results in the way of maintaining clean fires had been obtained on his road by the use of combination clinker tongs. These tongs were devised by Mr. William L. Williams, general traveling fireman of that road. The design of this appliance is clearly shown in the accompanying engraving. The appliance really combines three tools in one, namely, hooks, tongs, and chisel. The hooks are used to pull up the clinkers, and the tongs to remove them, the chisel coming into play when the clinkers are found stuck to the grates. The great advantage of this appliance is that fires can be cleaned on the road without loss of time, thus effecting a saving in time and of fuel. In a recent test 22 clinkers were removed in three minutes leaving the fire in perfect condition. The tongs are made of soft steel and weigh from 17 to 20 lbs. They can be made in any shop, it is stated, for a cost of something less than \$1.50. It will be readily understood that, aside from their main function, these tongs are also useful for removing bricks from arches and for removing broken grates. These tongs are now in use on the majority of Chicago & Northwest-



jected that the plow does not unload the cars clean but carries a large amount of material back and forth. Furthermore, in designs of this nature, it is claimed that the friction upon the stakes and the deck of the car is so great that an undue amount of power is required to move the plow. Other objections to the ordinary types of plows are that they injure the car sills, and stakes and stake pockets. Moreover, with such designs, three plows, a right, left and center, are required to properly distribute the material. It has also been found in practice that when the draft is always applied to the plow at the same point, as in the ordinary con-

a discharge of material to the point desired is indicated in figure 1. As shown in the full lines in that figure, the ear is in a central position and when drawn along over the decking of the car will discharge equal portions of the loading on each side. When it is desired to discharge the loading to either the right or the left the chain connections are released and the point of the plow swung to either right or left, as indicated by the dotted lines, the chains then being readjusted. To adjust the plow to suit the character of the material which is being handled, the clevis at the point of the plow,

wagon-top type, 1546 ft. of heating surface, 22 3/32 ft. of grate area, and weigh 114,000 lbs., of which 90,000 lbs. is on the drivers. The working pressure is 190 lbs. per sq. ft.

The boiler, as stated, is of the extended wagon-top type, and has an extended front. The longitudinal seams are hutt jointed and quadruple or sextuple riveted wherever practicable, with inside and outside welt pieces. The crown sheet is supported by radial stays. The front rows are sling stays with slotted holes for expansion. The extended front end is lagged and jacketed the same

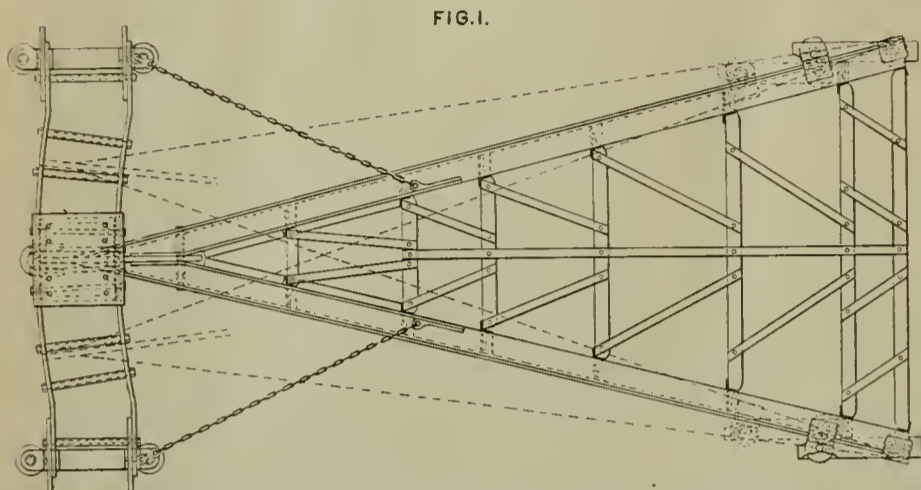

FIG. 1.

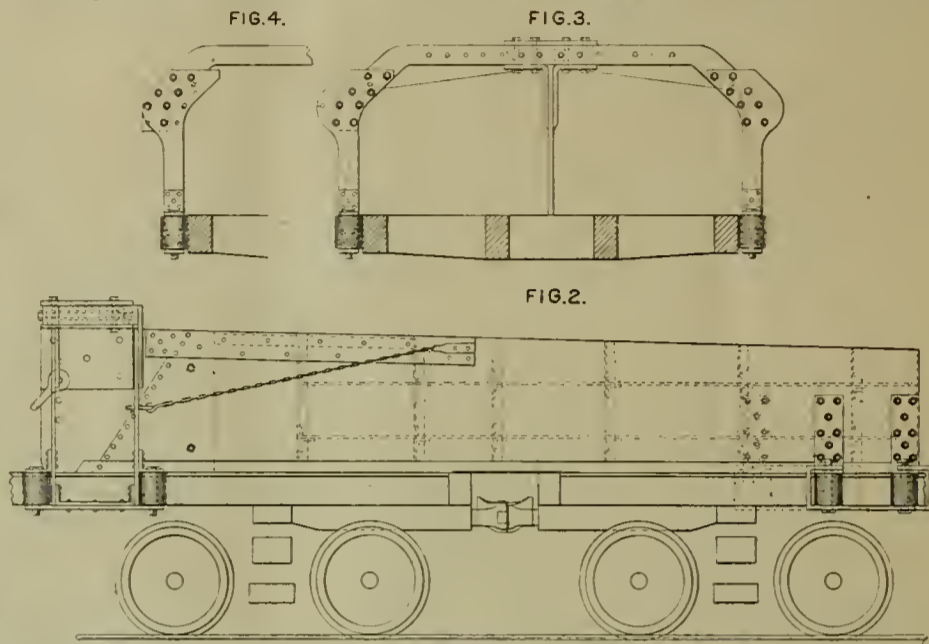

FIG. 4.

FIG. 3.

FIG. 2.

structions, the results are seldom satisfactory, as the plow is very apt to either tear the decking of the cars or ride on the material

In Mr. Warner's design these objections have been found, in practice, to be obviated. Side stakes and center guides are dispensed with, and the plow is guided by rolls on the sides of the car, thus removing the element of injury to the cars and reducing to a minimum the amount of power required to draw the plow. Moreover, a discharge to either side of the car is readily obtainable.

Reference to our detailed drawings will show how these ends are accomplished. Figure 1 gives a plan view of the ballast unloader, figure 2 a side elevation of the same in position on two cars, figure 3 a front elevation, and figure 4 a portion of the front elevation. This latter figure is given to show how the plow may be adjusted to a narrower car by moving one of the roller frames toward the center an extra set of bolt holes being provided in the frame for this purpose

The plow is guided and its true rectilinear movement over the decks of the cars insured by rolls, journaled in bearings near the rear end of the plow, on each side thereof, and to the ends of the transverse frame, shown at the front of the plow. These rolls run on the outer surfaces of the outside sills of the car-frame. In order to bridge over the spaces between the ends of one car and of the next one to which it is coupled, the rolls are disposed in pairs at each end of and on each side of the plow, each pair being set at such distance apart that one of the rolls is in contact with the sill of one car throughout the traverse of the other roll over the space between the cars, thus maintaining a constant bearing of the entire plow structure upon the sills at each of its ends. By the employment of front and rear pairs of rolls traversing on the sills as guides, friction is materially diminished, the transverse front frame and the rear end of the plow proper are independently guided, and the power required for the draft of the plow is correspondingly reduced

The rolls are journaled in suitable frames, which are connected to the side members of the plow and to the front frame-bars thereof, respectively, and in order to adapt the plow to use upon cars of different widths the bearing-frames are made adjustable, as we have before noted. Similar provision for varying widths of cars is provided at the rear, supplemental series of bolt holes being formed in the side members of the plow in advance of those used when the plow is adapted to cars of maximum width

The easy method of adjusting the plow to effect

A NEW BALLAST UNLOADER—NORTHERN PACIFIC RY.

to which is attached the draft cable, is moved up or down, suitable holes for the purpose being provided, as shown in figure 2. In this way the draft is applied to the plow according to the nature of the material, thus insuring against the plow digging into the car bed, or against riding on the ballast.

When applied to ordinary cars the rollers are given a smooth path by placing filling blocks between the stake pockets. In our photographic view,

as the boiler with sectional asbestos, covered with polished iron

The frame is of the best hammered iron, made in two sections. The pedestals are forged solid with the main frame and are protected from wear of boxes by cast iron gibs and wedges. The frames are 4 in. wide. The driving and truck axles are of hammered iron, and the wheel centers are of cast iron. The crank pins are of best quality steel, the

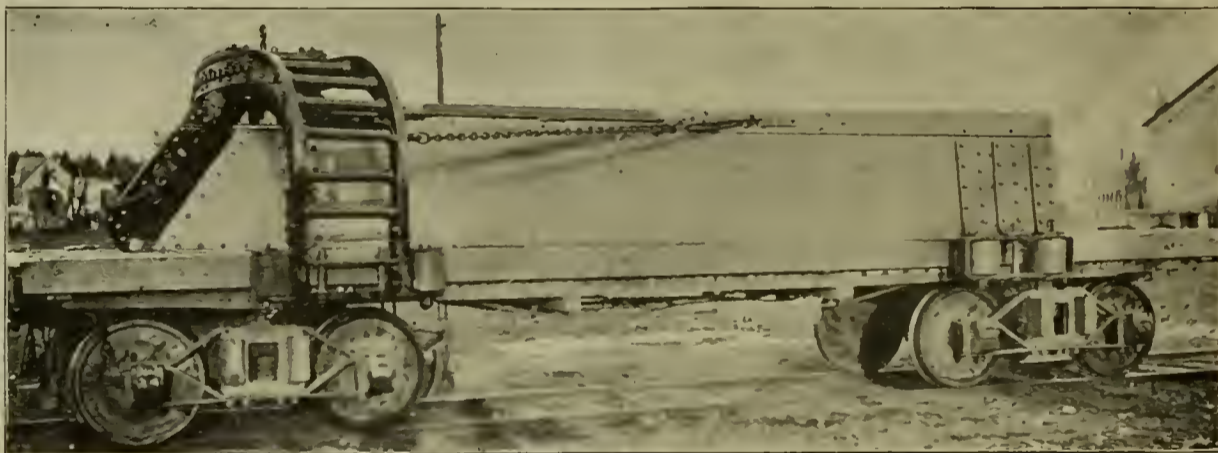

A NEW BALLAST UNLOADER—N. P. RY.—FIG. 5.

figure 5, this plow is shown in slightly modified form, all the essential details shown in the drawing being, however, preserved; and it will be noticed that the car upon which it rests has been provided with a metallic bearing for the rolls. This is, however, done only when the car is detailed for special and continuous service in ballasting work.

TEN-WHEEL FREIGHT LOCOMOTIVE—ST. J. & G. I. RAILWAY.

The ten wheel locomotive shown in the accompanying engraving is one of two built several months ago by the Rogers Locomotive Works for the St. Joseph & Grand Island Railway Company from designs prepared in consultation with Mr. A. C. Hinckley, master mechanic of that road. The engine was designed for freight service over a road containing grades running as high as 50 ft. to the mile. The engines are doing in practical service all that was expected of them, and the officials of the road and the men in charge of the engines like them very much. Two more, just like them, have recently been ordered from the Rogers works.

These engines have 17x26 in. cylinders, 60 in. driving wheels, 56 in. boilers of the extended

driving boxes of cast iron, the connection and parallel rods of hammered steel, the cross heads and guides of steel, and the piston rods of nickel steel. The principal dimensions of these engines are as follows:

Wheel base, driving.....	11 ft. 8 in.
Wheel base, total.....	22 ft.
Weight on drivers.....	90,000 lbs.
Weight on trucks.....	24,000 lbs.
Weight, total.....	114,000 lbs.
Cylinders.....	17x26 in.
Cylinders, steam port.....	1 1/4 x 16 in.
Cylinders, exhaust port.....	2 1/2 x 16 in.
Cylinders, bridge.....	1 1/4 in.
Driving wheels, diameter.....	60 in.
Heating surface, total.....	1546.50 sq. ft.
Grate area.....	22.33 sq. ft.
Working pressure.....	190 lbs.
Boiler.....	Extended Wagon Top.
Boiler, diameter.....	56 in.
Fire-box.....	.963-16 in. long, 33 3/4 in. wide, and 71 1/4 in. deep in front and 61 1/4 in. back.
Fire-box sheets.....	.....
.....Crown 3/8 in., side and back 5-16 in., tube 1/2 in.	.....
Tubes.....	219, 13 ft. 2 in. long and 2 in. diam.
Water space.....	4 in. front, 3 1/2 in. sides and back.

The engines are fitted with the following special equipment: Brakes, Westinghouse American; tender brake beam, Kewanee; bell ringer, Golmer; feed water heater, Rushforth; headlight, Pyle National Electric;

injectors, 1 Ohio, 1 Monitor; lagging, Franklin asbestos sectional; oil cups, Nathan; piston rod and valve stem packing, Sullivan's Metallic; slide valves, Amer-

in operation of a two way two position signal, this wheel comprises four spokes, a handle at the end of each spoke, a disc attached to each spoke, upon

be made the operator forms his combination in his mind; he then finds it displayed upon one of the discs, grasps the handle to which it is attached and brings it to the lock and thus has but one point to which to look for his indication, this being directly in front of him and on a level with his eye.

It will be noticed that the lock lever is provided with a paper book which is for the purpose of conveniently placing train orders or messages to be delivered, thereby acting as a reminder should they be forgotten and the operator proceed to turn the signal to clear.

It will be noticed that each disc is numbered. The number is, in fact, placed in the disc, but for the sake of clearness we here simply indicate its location. Thus in installing a division or system of road the disc indications and numbers are uniform. disc No. 5, meaning red or stop both ways being same in all offices. No. 3, meaning red, or stop, east bound and white, or clear, west bound, when once impressed upon an operator's mind in one office is likewise familiar to him in the next or any office to which he may be transferred.

A chart posted over the train dispatcher's table indicates the meaning of each number and by an operator transmitting the number at which his signal is set, the dispatcher is enabled to observe the positions of any signal, thereby checking the movements of any young or inexperienced operator.

The important features of this signal are a positive mechanism; a positive indication, at a given point to the operator of the existing positions of signal arms; absolute protection against forgetfulness in delivery of orders; and increased confidence in an important function in the handling of trains, namely the train order and block signal, by the dispatcher, operator, engineer and trainmen. This



TEN-WHEEL FREIGHT LOCOMOTIVE -ST. J. & G. I. RY

ican; sander, Houston; safety valves, 1 Coale, 1 Ashton; springs, French; tires, Latrobe and Midvale; truck wheels, McKee Fuller; tender coupler, Janney.

THE PAYNE TRAIN ORDER AND BLOCK SIGNAL.

The signal described by this article and accompanying cuts is although a new device, no longer an experiment, having been in operation on the Franklin division of the Lake Shore & Michigan Southern Railway for the past six months. It has demonstrated to all who have observed its workings that it is all its inventor, Mr. S. R. Payne, train master of that division, claims for it.

In the construction of this signal the familiar type of arms is not deviated from; any position may be used to convey the meaning desired. The control and oscillating motions, which operates the arms, is embodied in a cam mechanism attached to the pole, the irregular groove of the cam in the three position signal having nine distinct stopping places. Thus with the two arms the two cams, in nine stops, combine the two arms into nine combinations—that being all the possible combinations which can be formed. A brief study of the developments of this cam will reveal the principle of the mechanism by which the signal is operated.

which appears both in color and in raised position, one of the combinations possible in the operation of the signal. In case of a two way three position signal, such as we show, the wheel comprises nine spokes, a handle at the end of each spoke and a disc attached to each spoke, upon each of which appears, both in colors and positions, one of the possible combinations.

It will be noticed that at the lowest point on the wheel a spring lock is provided which locks any desired handle firmly at that point. The construction of the device is such that any disc and its accompanying handle when locked in the lock is the indication to the operator of the existing combination of the two signal arms.

It can readily be seen that when a change is to



The bearings for the cams and sliding rods are two brackets fastened to the pole. The rotary motion is conveyed to the cams by means of a single steel shafting. Next to the pole and next to the building knuckle joints are used. The connecting shafting between these two joints is hexagonal, each end being fastened into a hexagonal collar thereby forming an automatic compensator. The office connection consists of an upright shaft when necessary to bring the operating d'vée to the desired point, turns being made by bevel gear as shown.

The rotary motion is conveyed to the shaft by means of a wheel, placed directly over the telegraph table. The peculiarity of this wheel is that,

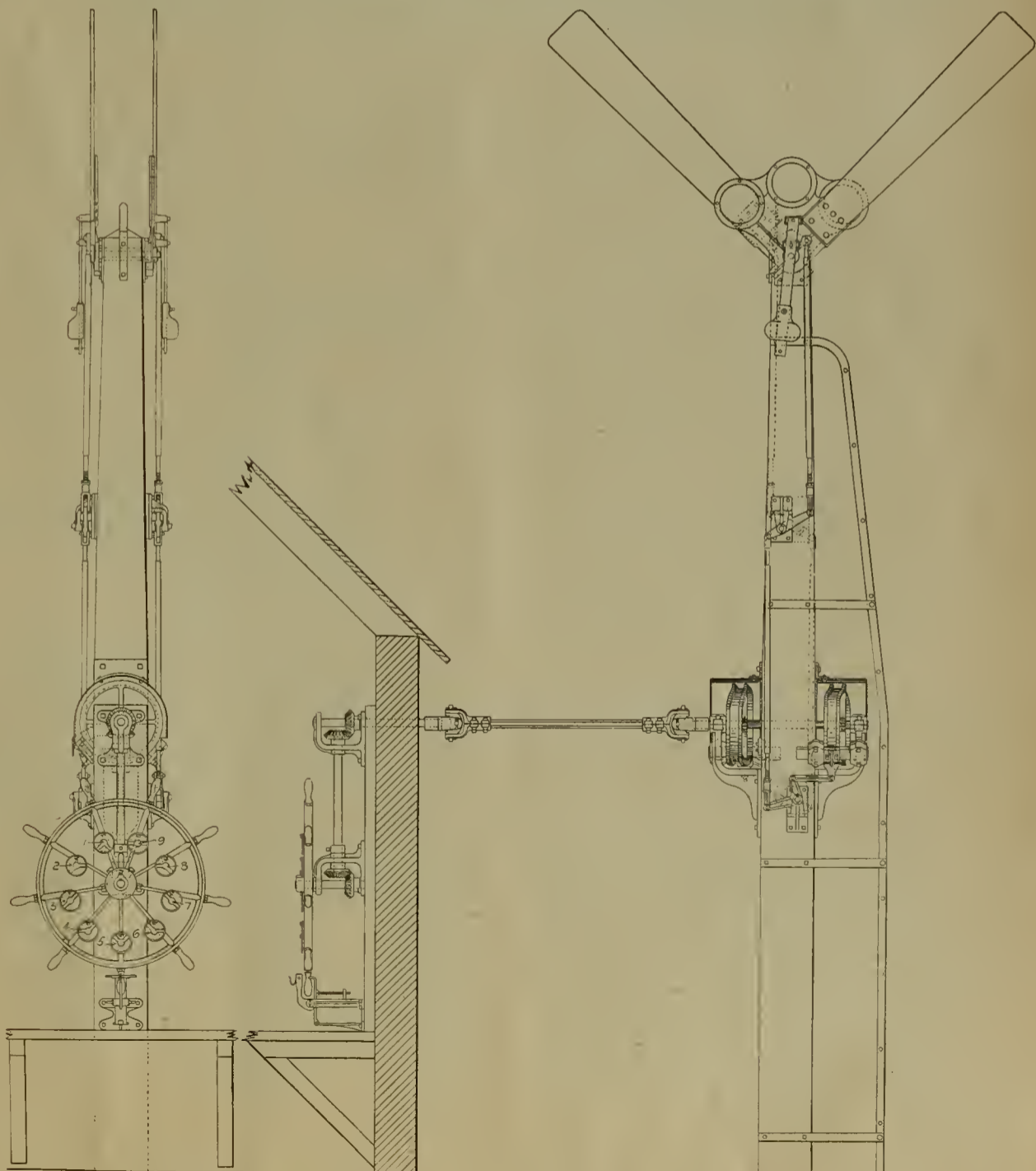

THE PAYNE TRAIN ORDER AND BLOCK SIGNAL.

signal is manufactured by the Payne Railway Signal, Switch & Equipment Company, of Ashtabula, O.

**THE FIRST RAILWAY TRAIN.**

Visitors at the World's Columbian Exposition will remember the painting, called "The First Train," which occupied the central position of the great historical exhibit of the Baltimore & Ohio Railway. A photo-engraving of the original painting has been published. It is in colors, and competent art critics pronounce it one of the best specimens of reproductive work which has been brought out in this country.

The original painting by E. L. Henry was the result of faithful study of all available historical ma-

but it is much shorter than the latter and consequently in no way interferes with the free operation of the handle A when applying the air brakes without track-sanding. The operations under the various conditions that arise in practice are thus described: For service braking and light track-sanding, operate both handles, A and B, together to service position, with one hand. For emergency braking and heavy track-sanding, operate both handles, A and B, together to emergency position, with one hand. For starting trains and light track-sanding, operate the handle C, one-half turn. For application of the brake without track-sanding, use only the handle A, and do not move the handle B.

This air valve is operated only by the engineer. It is always ready. It has no complicated parts to

daily use, and the engineers give the highest recommendations for its efficiency and adaptability. It can be applied to any track-sanding apparatus. It has been placed in the market by Theo. H. Curtis, Hickox Building, Cleveland, O., and any information concerning it will be immediately furnished on application.

**BOOK NOTES.**

The Watson-Stillman Company, 204 E. 43d St., New York, publish in pamphlet form an assortment of illustrated sheets covering railroad specialties in hydraulic tools, selected from their general catalogue. Their line of hydraulic jacks receives chief attention in this pamphlet, which also contains illustrations and descriptions of their hydraulic punches, rail benders, locomotive axle bearing presses, crank pin and wheel presses, and car axle straightening presses. The descriptive matter is rather more full than that usually found in catalogues.

We are in receipt of a catechism of the M. C. B. rules, issued by the McConway & Torley Company, of Pittsburg, Pa. It should be a very useful little book in the hands of car inspectors, and as it is of pocket size, will no doubt figure as a daily companion of car inspectors and their co-workers. An interesting appendix to the little book contains pictures of every part of the Janney, Janney-Miller, Janney-Buhoup, Buhoup-Miller, Janney freight, and Janney tender equipments. This book will be sent post free on receipt of request made to the McConway & Torley Company, Pittsburg, Pa.

"Painting to Prevent Corrosions, with Specifications," is the title of a handsome little book published by Edward Smith & Co., of New York. The work is written by A. H. Sabin, a prominent authority. The author says in his introduction that we need better and more thorough methods of painting far more than we need a new and improved kind of paint, a comparatively poor paint properly applied to a good surface being better than a good paint on a poor surface. The work is devoted chiefly to the proper method of treating and painting large structures, such as train sheds, bridges, buildings, etc. The subject in all its bearings is treated in very thorough and suggestive manner and an adequate index brings the valuable information contained in the work within easy reach of the reader. Typographically the book is a gem. The price of the book is \$1.25.

**AIR-BRAKE CATECHISM.** By Robert H. Blackall, Air-Brake Inspector and Instructor, D. & H. C. Co. R. R.; Member of Association of Railroad Air-Brake Men, American Society of Mechanical Engineers, etc., etc. For Firemen, Engineers, Air-Brake Instructors, Shop Men, and All Branches of Railroad Men. New York: Norman W. Henley & Co. Cloth. 240 pp. Price \$1.50.

This book is a complete study of the air-brake equipment, including the latest devices and inventions used. All parts of the air brake, their troubles and peculiarities, and a practical way to find and remedy them, are explained. The book is written in the familiar style of the class-room—the method used being that of the question and answer plan. The author has treated the subject in this manner, as the one best adapted to beginners; he has taken up each topic in its simplest form and then by progressive work has covered the more intricate parts of the topic as well, thus making a book valuable to men already advanced in their knowledge of the air brake. Trainmen and engine crews will find special and practical assistance to their work under the subjects Train Handling and Train Inspection. This book contains nearly 1,000 questions with their answers. It is completely illustrated by engravings and two large folding plates of the Westinghouse Quick-Action Automatic Brake, and also the 9½-Inch Improved Air Pump. These engravings were all specially made for reference in the study of the various parts and workings of the air brake. The author's many years' experience as air-brake inspector and instructor on the D. & H. C. Co. R. R. enables him to know at once how to treat the subject in a practical and plain way. Mr. Blackall stands in the very front rank of the air brake inspectors of this country and any book bearing his name upon its title page commands interested attention.



THE FIRST RAILWAY TRAIN —PAINTED BY E. L. HENRY.

terial and the greatest care to secure accuracy in detail. The portraits and costumes themselves were individual studies and not mere figments of the imagination. The artist had the advantage of consulting persons who were present at the scene depicted, and who, though advanced in years, had preserved a clear recollection of the event which proved so important.

The scene represents the starting of the first railway train on the Hudson & Mohawk Railroad, drawn by the locomotive "De Witt Clinton," September 9, 1831. The Old Hickory Inn, shown in the picture, was two miles from Albany. David Mathew was the engineer and John C. Clark the conductor, and there were well known public men among the passengers.

The picture is a most appropriate one for the railway office or for the home. It will bear careful study and will afford unfailing satisfaction. It can be seen, we understand, at almost any first-class art dealer's. It can also be obtained of the publishers, C. Klackner, 7 W. 28th street, New York. The size of the engraved surface is 14x34½ ins., and the price of artist proofs is \$15 each.

**THE CURTIS DUPLEX AIR VALVE FOR PNEUMATIC TRACK-SANDING APPARATUS.**

With the present demand for faster travel for the passenger train and the increased speed at which freight is transported, comes the demand for means, having the highest efficiency and accuracy, for controlling the speed of these trains. The air brake is now operated with the greatest accuracy and with instantaneous application. The pneumatic track-sander is now being applied to all fast locomotives. With the Curtis Duplex air valve, the air brake apparatus and the pneumatic track-sanding apparatus can be operated as one, or either can be operated independently of the other. This combination of the air brakes and the track-sanding apparatus produces the highest efficiency in controlling the speed of any train. Our engraving shows this air valve applied to the Westinghouse engineer's valve. In operation it is simplicity itself. Its operating handle, B, is directly over the handle A of the engineer's valve, when in running position,

get out of order. It has no cut-out valve which is liable to be closed at some critical moment when track-sanding is required for emergency train-braking. Prominent lines have this air valve in

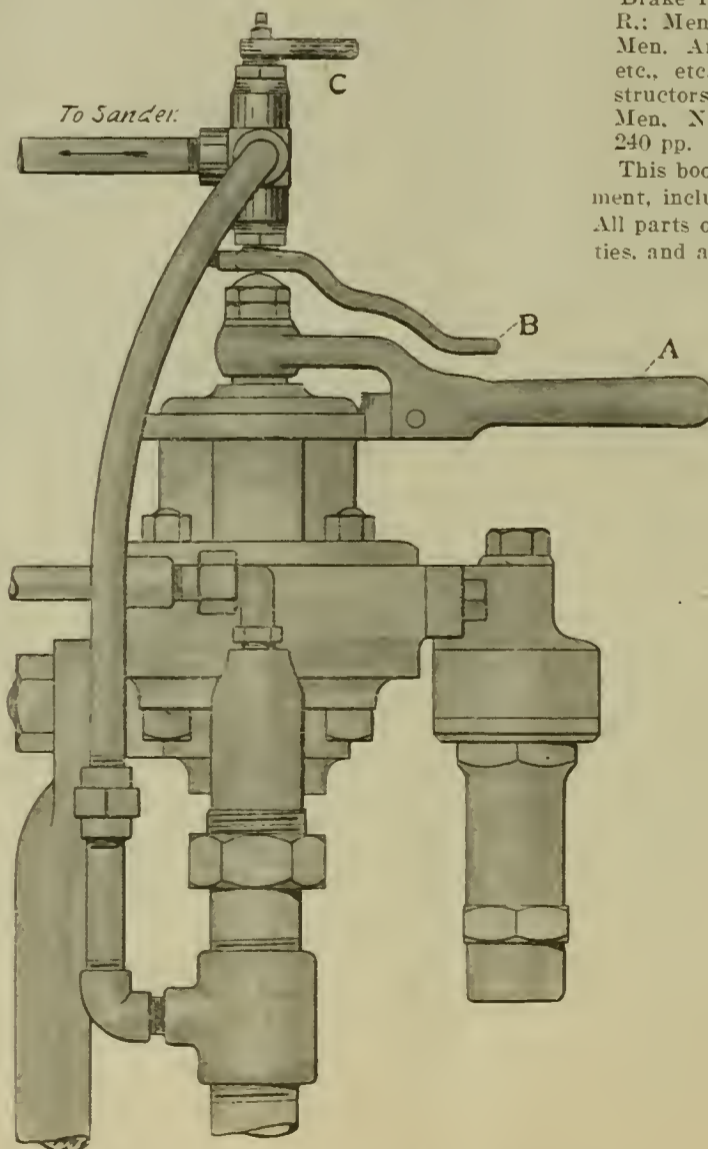

THE CURTIS DUPLEX AIR-VALVE. Applied to the Westinghouse Engineer's Brake Valve.

**PERSONAL.**

Mr. C. H. Roser has been appointed purchasing agent of the Detroit & Lima Northern, vice C. W. Taylor, resigned.

Mr. James Carmichael, superintendent of the machinery department of the Harlan & Hollingsworth Company, is dead.

Robert W. Hunt & Co. have moved their New York office from 80 Broadway to the New Empire building, 71 Broadway

Mr. B. S. McClellan has been appointed master car builder of the Fort Worth & Denver City, with office at Fort Worth, Texas

Mr. Otto Burgert has been appointed foreman of the shops of the Vandalia Line at East St. Louis, Ill., vice Mr. Charles Butler, resigned.

Mr. W. H. H. Price, foreman of car repairs of the Southern railway at Atlanta, Ga., died in that city, October 8, at the age of 58 years.

Mr. J. W. Platten has been appointed assistant purchasing agent of the Erie lines, with headquarters at 21 Cortlandt street, New York

Mr. H. T. Bentley, foreman of the Chicago & North-western shops at Belle Plain, Ia., has been appointed general foreman of the Clinton shops.

Mr. John T. Rees has been appointed acting chief storekeeper of the Denver & Rio Grande Railroad, vice Mr. Wm. C. Fergus, resigned

Mr. A. F. Agnew has been appointed roundhouse foreman of the Duluth, South Shore & Atlantic, at Marquette, Mich., vice G. A. Gallagher.

Mr. E. D. Jameson has been appointed assistant master mechanic of the western division of the Grand Trunk, with office at Battle Creek, Mich

Mr. E. C. Palmer, secretary and general manager of the Standard Tool Company, of Cleveland, Ohio, died at Stockbridge, Mass., October 13th.

Mr. T. W. Sloan has been appointed foreman of car department at the New Orleans terminals of the Illinois Central, vice B. S. McClellan, promoted.

Mr. C. A. Delaney, formerly superintendent of the Richmond Locomotive Works, has been appointed superintendent of the Dickson Locomotive Works.

Mr. A. D. Hart has been appointed superintendent and master mechanic of the Manistee & Grand Rapids, with headquarters at Manistee, Mich., vice W. H. Herbert, resigned.

Mr. L. A. Jackson, chief clerk in the office of Purchasing Agent R. T. Evans, of the Pittsburg & Lake Erie Road died suddenly at Pittsburg, early in October, aged 50 years.

Mr. A. S. Work, formerly traveling engineer of the New York, Chicago & St. Louis, has been appointed traveling engineer of the Wabash, with headquarters at Moberly, Mo.

Mr. Peter Gable, for the past five years master mechanic for the Iron Mountain Railroad Company at Texarkana, has resigned, and has been succeeded by Traveling Engineer Beck.

Mr. W. H. Garlock is master mechanic, W. L. Wilson, purchasing agent and J. W. Young, general storekeeper of the White Pass & Yukon Ry. The headquarters are at Skaguay, Alaska.

Mr. J. S. Chambers, formerly with the Illinois Central, has been appointed superintendent of motive power of the West Virginia Central & Pittsburg Railway, 1898, vice Mr. J. S. Turner, resigned.

Mr. Paul J. Myler, at present secretary of the Westinghouse Mfg. Co., Ltd., at Hamilton, Can., will succeed Geo. F. Evans as manager when the latter leaves for St. Petersburg, Russia, to establish a plant there.

Mr. Charles Butler has been appointed general foreman of the Chicago & Eastern Illinois, with headquarters at Moline, Ill. Mr. Butler has hitherto been foreman of shops of the Vandalia at East St. Louis.

Mr. S. K. Hart has been appointed road foreman of engines of the Altoona and Cambria, and Clearfield divisions of the Pennsylvania Railroad, and of the engines and engine crews assigned to the Altoona shop yards.

Mr. J. B. Boyer has been appointed chief motive power clerk of the Pennsylvania Railroad with office at Altoona, vice B. F. Custer, deceased. Mr. Boyer has been acting as chief motive power clerk since February 14, 1898.

Mr. Charles H. Felske, foreman of the shops of the Wabash at Montpelier, Ohio, has been appointed foreman at Delray, Mich., to succeed Mr. H. K. Mudd, resigned, and Mr. George F. Hess has been appointed foreman of the Montpelier shops.

Mr. W. H. Russell, traveling engineer of the Southern Pacific, between Bakersfield, Cal., and El Paso, Tex., has been appointed assistant master mechanic of the road at Oakland, Cal., and Mr. Jesse C. Martin has been made traveling engineer.

Mr. B. F. Snyder, formerly general foreman of the machinery department at the Conneaut shops of the New York, Chicago & St. Louis, has been appointed master mechanic of the Columbus, Sandusky & Hocking, vice T. M. Downing, whose resignation we have previously noted

Mr. John Lundie has removed from Chicago to New York to act as Consulting Electrical Engineer for the Brooklyn Elevated Railroad and he is now preparing the preliminary plans for changing the motive power of the Fifth and Lexington avenue lines in Brooklyn, from steam to electricity.

Mr. H. E. Passmore has been appointed master mechanic of the Western Maryland, with headquarters at Hagerstown, Md. David Holtz has been heretofore master mechanic, with headquarters at Union Bridge. Mr. Passmore has been heretofore foreman of the Philadelphia & Reading shops at Tamaqua

Mr. S. E. Busser has been appointed superintendent of reading rooms of the Atchison, Topeka & Santa Fe system. It will be his duty to visit all reading rooms on the system and see that they are kept in proper condition, and to report to the general managers of the several roads as to what changes, if any, are needed.

Mr. John Lawrence, general foreman of the Norfolk & Western, at Columbus, O., has resigned and his position has been filled by the promotion of George Burdell, for some time foreman of the Norfolk & Western trains at the Columbus Union station. Mr. Burdell is succeeded at the Union station by W. Loveberry.

Mr. Thomas A. Fraser, superintendent of the Wells & French Car Shops, shot himself at his home in Chicago Oct. 13, dying instantly. Illness and consequent despondency are cited as the causes leading him to take his life. Mr. Fraser was widely and favorably known, not only through his connection with the Wells & French Company but through his former position in the railway world as master mechanic of the Minneapolis, St. Paul & Sault Ste. Marie Railway.

Mr. J. S. Turner, superintendent of motive power of the West Virginia Central & Pittsburg, has resigned, to enter the service of the Standard Pneumatic Tool Company. The Railway Age gives the following account of Mr. Turner's railway career: Mr. Turner began his railway career in 1875, and served an apprenticeship of four years in the shops of the Cumberland & Pennsylvania road. He was then for five years machinist in the Altoona shops of the Pennsylvania Railroad, and in 1884 went to Mexico as master mechanic of the Mexican Central. From 1886 to 1891 he was with the Eames and New York Air Brake companies, and returned to the Mexican Central in 1891 as master mechanic. The following year he accepted the position of assistant mechanical superintendent of the Mexican International, and left that road in 1894 to become superintendent of motive power of the West Virginia Central & Pittsburg.

Mr. W. B. Snow, well remembered as the master mechanic of the Illinois Central, died at his home in Chicago Oct. 20, age 78 years. Mr. Snow was born Feb. 13, 1821, at Bellows Falls, Vt. where he received a common school education and early became an expert in the use of woodworking tools and machinery in his father's shop. In 1844 he entered the railway service in which he was destined to work so successfully for nearly half a century. He was at first with the "Western Railroad" of Massachusetts, and in 1850 became foreman of the passenger car department of the American Car Company at Seymour (then Humphreysville), Conn. In 1852 Mr. Snow came to Chicago and contracted to build six coaches for the Chicago & Galena Union Railroad, the nucleus of the present Chicago & Northwestern system. Mr. Snow next took the contract to build all the passenger coaches for the American Car Company. In 1857 he began the connection which lasted until 1891, save three years—from 1872 to 1875—when he was traveling inspector for Pullman's Palace Car Company. In the last named year Mr. Snow was made master mechanic of the Illinois Central Railroad, a position which he held continuously until he withdrew from all business activity in August, 1891. Mr. Snow leaves a wife and daughter.

**CAR FOREMEN'S ASSOCIATION OF CHICAGO.**

**OCTOBER MEETING.**

The Car Foremen's Association of Chicago held its regular monthly meeting at the Great Northern Hotel, Chicago, on Monday evening, October 17, 1898, President Hunt in the chair and a large number of members in attendance. Among these present were:

- Anderson, A.
- Boheu, W. J.
- Blohm, Theo.
- Baikie, J. C.
- Burnett, R. W.
- Callahan, J. P.
- Coleman, J.
- Cook, W. C.
- Constaut, E. J.
- Davies, W. O., Sr
- Davies, W. O., Jr
- Fritz, Chas.
- Groohey, Geo.
- Grieb, J. C.
- Goetzen, R. J.
- Guthenberg, Bruno
- Greco, C. E.
- Hansen, A.
- Holtz, Christ.
- Hagge, Wm.
- Hermig, Henry.
- Harrigan, W. C.
- Hook, Fred.
- Johannes, A.
- Jones, R. R.
- Kroff, F. C.
- Krump, M.
- Kramer, Wm
- Kennicott, Geo
- Kamen, Fred.
- La Rue, H.
- Longfellow, F.
- Miller, M. M.
- McLaren, J. G.
- Nordquist, Chas
- Olsen, Louis.
- Rapp, M. E.
- Stuckie, E. J.
- Smith, E. B.
- Stagg, C. S.
- Stocks, Jas
- Shannon, S.
- Schocneberg, C
- Showers, G. W.
- Senger, Wm
- Silvus, W.
- Thiverge, J. C.
- Trixler, A. F.
- Thrull, Jno.
- Williams, Thos.
- Wentsel, Geo.
- Wolfe, Chas

On motion, the reading of the minutes of the previous meeting was dispensed with; they were approved as published in the Railway Master Mechanic.

Under the head of unfinished business, the motion made by Mr. T. R. Morris at the previous meeting respecting certain changes in the by-laws, was taken up, considered, and there being no dissenting vote, was carried.

**Reports of Officers.**

The secretary and treasurer's report was then presented as follows.

Chicago, Ill., October 17th, 1898.

The first year's work of our Association is marked by the growth in membership, the high-class work and the notably well-prepared papers presented at our meetings.

This Association was organized on Oct. 6th, 1897, with nine charter members. We now have seventy-four members. When organized our by-laws provided that only those who were actively engaged in car work were eligible to membership. Since that time our by-laws have been revised and at this date we have representative members from all branches of the mechanical department, as well as the supply salesmen who have so materially aided us in making this day a successful peace jubilee

When first organized we held our meetings in the afternoon, but, finding that our average attendance was small, owing to the fact that it was difficult for foremen and inspectors to absent themselves from their respective places of business, it was thought advisable to change to evening sessions. This resulted in an increase of the average attendance from sixteen to eighty-five.

The financial statement for the year is as follows: Amount on hand Oct. 6th, '97, \$00.00 (date of organization.

Amounts received during the year from all sources .....	\$74.00
Amount of disbursements for the year.....	62.22

Cash balance on hand, .....	\$11.78
Itemized statement attached.	

Respectfully submitted,

Will E. Sharp, Secretary.

Approved:

Richard Wharton, Treasurer

The report was approved as read; and later an auditing committee reported approving the report and the books of the officers

Mr. S. J. Kidder, of the Westinghouse Air Brake Company who had expected to be present and address the meeting, was unable to attend on account of absence from the city. His paper prepared on the subject of Air Brakes was sent in, the same being read by Mr. W. O. Davies, Jr

**Mr. Kidder's Paper on Air Brake Practice.**

There was a time not so very long ago when the general sentiment among railway people was that air brakes for freight cars were more of an expensive luxury than a necessity and that if adopted they would fail to prove sufficiently advantageous to justify the innovation. But practical experience since that time has convinced the most skeptical of their error and today the air brake is looked upon as one of the most, if not the most, important adjunct to railroad operation—for safety is the ruling consideration and its mission is largely in that direction.

This being true their neglect, which can be frequently observed, leads to the conclusion that the air brake is too often assumed to be automatic in maintenance as well as in action; and perhaps to this may be attributed the neglect to which they have been, and still are to a very considerable extent, subjected, until some glaring defect demonstrates itself, which must be corrected to prevent the brake being utterly useless or,

perchance, a barrier to the proper operation of the other brakes in the train.

No railway device, with the possible exception of the vertical plane coupler, has forged its way into general use with the rapidity which has characterized the air brakes, and it would seem that prudence alone would be a sufficient incentive to cause earnest efforts to be made in the direction of maintaining at a high degree of efficiency this important factor of railway operation. It is a gratifying fact, however, that with the rapid increase of power brakes in freight train service a commendable effort can be observed in many directions to maintain the brakes in a condition to render them capable of performing the important duties for which they are intended.

It is a well recognized fact that no matter how perfect the mechanism of the locomotive and other rolling stock, the track, the bridges or even the suspended telegraph wires, which latter would be presumably out of harms way, all require frequent repairs and attention, and I fail to comprehend why the air brake should not receive equal care and consideration.

The air brake occupies a position peculiar to itself, inasmuch as the working of the brake on one car is so intimately connected with the operation of all the others in the train that a little oversight or negligence in the maintenance or repair of the individual brake may, and not unfrequently does, seriously interfere with and influence the performance of all causing results of a more or less undesirable character.

Now, assuming that what has been said is true, and I believe you will all agree with me to whom must we look for this needed care and attention to insure effective brake service. Obviously to the car foreman and his subordinates, for upon them properly devolves the work, and if his department maintains the air brake equipment in even a fairly normal condition desired results will be realized and the air brake will be then the potent factor of safety intended, and the oft repeated assertion of "air-brake failure" will be relegated to the archives of visionary platitudes, at least so far as the responsibility of the car foreman is concerned.

That portion of the air brake with which the car foreman has to do is largely the car equipment, of which the triple valve is the vital part. In the repairs of this valve the substitution of gaskets too thick or too thin, springs of improper tension or a poorly fitting piston packing ring, are all defects of a serious character. Repairs of triple valves should not be made by car inspectors or repairers who have not had the special training necessary for the proper performance of the work, but rather placed under a limited number of men, at one or more convenient points on the road, possessed of the necessary qualifications and with the requisite tools at hand to do the work efficiently.

The only triple valve repairs that should be permitted at other than the special repair points are, in addition to cleaning and oiling replacing of gaskets other than the leather ones, changing defective emergency valves for perfect ones, renewing broken bolts or displacing a triple valve otherwise in bad order by a perfect one.

Another important matter that demands the attention of the car foreman is the replacing of removed levers by others of the same proportions, for in the event of ignorance on the part of the repairman a lever with the proper number of holes, regardless of its proportions, may replace the removed one, resulting in furnishing a prolific source for skid wheels.

In adjusting piston travel it should not be done with a pressure far below that usually employed in service, as this low pressure may not be sufficient to deflect the brake beams or take up the lost motion which prevails in the connections, tilting of and lost motion in the trucks, etc. When the car is in motion, and the brakes are applied with nearly or quite a full pressure, the taking up of the lost motion results in a considerable increase of piston travel and a reduction of the braking power of the car several thousand pounds to say nothing of the possible danger of the piston striking the cylinder head.

The pipes, cylinders and reservoirs and cocks must also receive their share of attention to insure reliable brake performance. The cylinder and reservoir, of freight cars particularly, require substantial attachment to the car sills, for the entire strain from the cylinder pressure is exerted on the bolts which support them. The pipes should always be firmly clamped to prevent vibration and shifting, and to avoid the possible dismemberment of the piping of a car in the event of a break-in-two of the train when hose couplings happen to be frozen or otherwise fail to detach. The position of the angle cocks should be such as prescribed by the Master Car Builders' Association, for many break-in-twos, with attendant damage to draft gear, have resulted from improperly located angle cocks which did not permit of sufficient sag in the hose to make suitable provision for long draw bar couplings.

Red lead or other substances of a similar character should never be put inside the angle cock or fitting before screwing on to the train pipe. If this is done the lead sooner or later finds its way to the triple valve strainer or the valve itself, or the brake valve, where

its presence, to say the last, is by no means desirable.

I believe it very important that every car foreman should familiarize himself with the formulas for calculating leverage. It may be stated as a general proposition that skid wheels are the result of one of two conditions; either an excessive leverage or a too high air pressure. In designing brake gear 60 pounds per square inch is always assumed as the maximum pressure that is brought to bear upon the cylinder piston. Taking this as a basis the force applied to each brake beam can be readily determined by ascertaining (a two foot rule is all that is required) the proportions of the different levers through which the power is communicated from the cylinder to the beams, and noting the different classes of levers employed.

Every well regulated division point should be provided with a plant for testing brakes on cars and trains. The one thing needed is ample main reservoir capacity, as with a medium size pump it will furnish the requisite quantity of air. The large reservoir gives a volume of air which maintains a good pressure during the time consumed in charging the auxiliary reservoirs, while if the pump is depended on much useless time is consumed, when charging medium or long trains.

Opening the angle cock or parting the hose couplings is not a proper method of testing brakes, for with this procedure the brakes will often perform in an apparently proper manner, a manner which in fact may be widely at variance from their performance in actual service.

A standard brake valve, mounted on a carriage for convenience in moving about the yard, with an air gage and suitable connections for the main reservoir and train pipe is preferred for with such outfit the brakes are intelligently tested and under practically the same conditions as when handled from the engine.

The maintenance of air brakes on freight cars has not been secured when a few of the roads have established suitable testing plants and inaugurated a systematic care of them, for, under these conditions, the maintenance ceases when a car enters the line of a road not prepared to do the work. The object sought for will only be attained when some plan is universally adopted whereby an air brake will have attention when it is away from home the same as when it is on its own line.

In order that the good condition of air brakes on freight trains may be maintained it will be necessary for railroads to do two things, i. e., adopt some protective system whereby brakes coming on their line from other roads shall be in first-class condition before the car is accepted, and establish a defect card system so that disorders, arising en route may be reported upon reaching the terminal. While this may appear to be outside the province of the car foreman it is in his power, to some extent at least, to exert an influence among those who have the authority, but do not realize the importance of such an innovation, or the benefits to be derived in keeping the air brakes in a suitable condition to render the service for which they are intended.

The passenger air brake equipment is so well maintained generally that it is perhaps unnecessary to consider it at this time, but there is one element which is intimately connected with the passenger car apparatus, on many of the fastest and most important trains, which demands more than passing consideration. I refer to the water-raising system of Pullman cars. The water raising system has introduced a feature of occasional erratic brake performance that is not generally understood, but with which the car foreman and his men should be familiar. The water pressure apparatus when in proper condition is not a detriment; when otherwise it becomes a disturber of the brake's stability, and mysterious actions of the brakes may at times be cleared up by an understanding of the water raising system. The system will not become an abundant success, so far as the brakes are concerned until measures of inspection and maintenance shall have been established whereby water and back pressure will be prevented from leaking into the air brake system. The former is liable to cause trouble with the triple valve in cold weather; the latter to skid the wheels of the car.

In the foregoing I have endeavored to point out a few of the prominent features pertaining to air brakes. To attempt to do the subject full justice would tax both your time and your patience.

If anything I may have said takes root and results in improved brake service, if only in a very limited degree, I will feel amply repaid for my efforts to entertain and possibly to some extent enlighten you.

The following report of a committee on resolutions was read and adopted:

#### Report of Committee on Resolutions.

Whereas, through the courtesy and liberality of a number of railway supply men, railways and other companies and other individuals the "Car Foremen's Association of Chicago" has been enabled to offer to its members and their friends an excursion over the Belt Railway Line, and a visit to railway shops, steel works, and other points of interest; therefore, be it resolved, that the Association extends to the various

parties its heartiest thanks and appreciation for the favors shown; and be it resolved further, that the secretary of the Association be instructed to forward to each individual and company shown below, who contributed to our enjoyment, a letter embodying the sense of the above, explaining the sentiments of the Association.

First—To Mr. J. M. Warner, superintendent; Mr. P. H. Peck, master mechanic, and Mr. J. W. Callahan, general yardmaster of the Belt Railway, for transportation facilities.

Second—To Mr. Geo. A. Coe, superintendent C. & E. Ry., for the use of passenger cars.

Third—To the various railway supply men for their cash contributions.

Fourth—To Mr. F. W. Getty, superintendent dining and sleeping cars, and Mr. Hollingsworth, his assistant, of the C. M. & St. P. Ry., for their services in arranging for the lunch on train.

Fifth—To Mr. C. A. Schroyer, superintendent car department C. & N. W. Ry.; Mr. F. W. Brazier, assistant superintendent machinery, and Mr. J. W. Luttrell, master mechanic, of the I. C. Ry., and to the officials of the Illinois Steel Works, for courtesies extended to us in our visit through their respective works.

#### Election of Officers.

The nominating committee presented the following names as candidates for the various offices:

President, T. R. Morris.

Vice-President, W. E. Sharp.

Secretary, W. C. Cook.

Treasurer, E. B. Smith.

Upon motion, the nominating committee's report was accepted; the nominations closed, and the secretary instructed to cast the ballot for the nominees, who were thereupon declared duly elected.

Mr. Hunt then made the following address:

#### President Hunt's Address.

I suppose it will be in order for me, and probably expected of me as retiring president of this association, to say a few words before stepping aside that my successor may be ushered in.

While I have had a very pleasant official term, and appreciate the honor bestowed upon me by being made your first president, I am willing and, in fact, pleased to step down and join the ranks in order that our worthy member, Mr. Morris, may be placed in command. As I said before, my official term has been a pleasant one, made so by having the full support of the association and its officers, and I shall be more than pleased if our president-elect receives the hearty support that has been given me, and I feel assured that he will, and can assure you that I shall be very greatly disappointed if he doesn't—but we will have no fear of this.

I believe that it will not be out of order at this time for me to give a short history of our association and its first year's work, because we are not nearly all of us charter members, so to speak, and therefore possibly do not know all that has transpired as to organization, etc. I do not mean to tell you all that has transpired, as that would take too long, but only some of it:

To begin with, I will ask you to bear with me while I look backward a few years before the present association was launched. I think it was about fourteen or fifteen years ago or somewhere in that neighborhood that an association of this nature was started here by the car foremen. The association met regularly once a month, it assumed some proportions, had by-laws governing it and was conducted in the regular order of associations of this nature; but it was short-lived, there was evidently something lacking, it soon got the disease known as "members losing interest," the attendance became smaller from month to month and, consequently, it soon ceased to exist.

In 1892 another association was organized with Mr. Thomas Doig, at that time car foreman of the C. & G. T. Ry., as chairman. A great many of the foremen and inspectors in this district joined the association; we met regularly once a month in Mr. Doig's office at their passenger yard, near 12th street and the Grand Trunk tracks. This association was not well organized and, like its predecessor, it too dwindled to almost no attendance at all, and finally it passed out of existence.

To come down to our present association: On Friday, Sept. 24, 1897, a meeting of the car foremen of some of the roads converging in this Chicago terminal was held in room 560, Old Colony building; the meeting being called by Mr. W. E. Beecham, car accountant of the C. M. & St. P. Ry., for the purpose of discussing the matter of handling bad order cars in this terminal and the advisability of adopting some uniform method of carding and marking the same that they might be handled with dispatch. The following roads were represented: L. N. A. & C. Ry.; C. R. I. & P. Ry.; Wisconsin Central Lines; C. G. W. Ry.; A. T. & S. F. Ry.; B. & O. R. R.; Wabash R. R.; C. B. & Q. R. R.; Pennsylvania Company; P. C. C. & St. L. Ry.; C. M. & St. P. Ry.

The subject was very thoroughly discussed and a motion was made by Mr. Morris of the C. M. & St.

P., that a committee of five be appointed to confer with a like committee of the car service officers in regard to the marking and carding of bad order cars and their disposition thereafter. This motion prevailed and the chair appointed the following committee:

Mr. T. R. Morris of the C., M. & St. P. Ry.; Mr. J. P. Callahan, of the B. & O. R. R.; Mr. R. R. Jones, of the C., G. W. Ry.; Sidney Upton, of the Wabash R. R.; and myself, as chairman, representing the Pennsylvania Company.

There being no further business before the meeting it was adjourned to meet again at the same place on Oct. 6th to hear the report of the committee. The meeting of Oct. 6th was held and the business gone through with, after which Mr. Beecham requested that the meetings be continued and a permanent organization be formed. This was thought well of by all present and a call was made for October 20th and was responded to by the following, who were the charter members:

T. R. Morris, R. R. Jones, H. H. Manthey, J. P. Callahan, S. Upton, C. Deen, R. Wharton, W. E. Sharp and myself.

We met regularly on the second Thursday of each month at 2:00 o'clock p. m. We began taking in new members and, while there was great interest taken by those who attended, still the attendance was small, mostly owing to the time of day meetings were held, and it was thought by some that by changing the meeting time to evening instead of afternoon the attendance would be greatly increased. This was done with very flattering results, as you are all well aware of; our membership has grown from nine charter members to one hundred members. Hence, we feel very much encouraged. We are now entering upon our second year of existence and I am glad to say that the outlook is bright. As to our meetings in the past, I think I can safely say that we have looked forward to them with pleasure. There have been a great many questions brought up from time to time by some of the members who had knotty questions come before them in their regular business, and in order to settle them and get the greater weight of opinion they have asked to have the association discuss them. In this way our meetings have been made interesting and we feel that some good has been accomplished. Where there was a difference of opinion on some question arising in the matter of interchange of cars, if they so agreed, the matter was laid before the association. They both could not be right but had to submit to the preponderance of opinion, and the one to come down did it gracefully and with no hard feelings, so that our meetings have been very harmonious indeed and any show of temper was never carried beyond the discussion. Hence, good-fellowship has reigned during this our first year of existence and I hope it may continue and that the second year just ushered in may be one that will far excel the first in every way, in well-doing so far as the association work is concerned, also socially and financially.

Therefore, feeling that the several officers who are just about to take their chairs will get the fullest support from all the members, and to make room for our worthy president-elect, I cheerfully stand aside. Gentlemen, I thank you.

#### Responses of New Officers.

The newly elected officers then responded to calls as follows:

President Morris: Gentlemen, I thank you very much for the honor you have conferred in electing me your president, and I will do the best I can, with the help of all, in making the Association a success. Mr. Hunt has spoken about what we have done in the past, and I can only hope that we will continue to do good in the future. But in order to do so, we must have the help of all; two or three cannot do the work and make a success of it. I thank you again.

Vice-President Sharp: You have heard from me once this evening and I hardly think I can add to what the retiring president has said. We have now come to a point where we can meet and agree, and if there is a difference of opinion about a car, you will notice that it is held and disposed of, and extra switching avoided; and I think that to the organization which we are here to-night to celebrate some of the credit is due. The first year of our work has been good and will materially assist us in the future. I thank you.

Secretary Cook: Mr. President: I think that the newly elected secretary, not having been among you to any great extent, should be exempt from being called upon for any speech. I think he will have to do considerable between this and the next meeting in order to get in trim for what he will be compelled to do. However, I appreciate the honor in being elected secretary of the Association and will do all in my power to fill the position in an acceptable manner, and also endeavor to make as great a success of it as did my predecessor.

Treasurer Smith: Mr. President: The old treasurer not being here to respond, I, of course, will not be expected to make a long speech. I thank you, gentle-

men, for the trust you place in me in electing me your treasurer. I will do my best to fill the position.

President Morris: As the hour is very early, we might take up some questions, if any one is laboring under difficulty, and by discussion perhaps help him out.

#### Second-Hand Hose on Foreign Cars.

Mr. Grieb: I think in view of the peace jubilee we ought not to bring up any questions that could disturb the harmony that prevails. We all have our little troubles, of course; but still it may not be out of place to broach some of them and have them ventilated. There is just one point that occurs to me now that might be taken up for discussion. That is the matter of using second-hand air hose on foreign cars under conditions that would warrant a bill being rendered against car owner. We have had several cases in which we have been presented with bills covering defects which, if properly repaired, would have been subject to bill under the rules. We were compelled to take exception to these bills for the reason that second-hand air hose had been applied. We maintain that we were entitled to new air hose. This point is not very explicitly covered by the rules as they exist at present. It seems that since '96 there is no provision made either for or against the use of second-hand air hose. In '97 a provision was inserted allowing the use of second-hand couplers and metal brake beams. This, previous to '97, was not permitted. When this change authorizing the use of second-hand M. C. B. couplers and their parts, and metal brake beams, was put in, some how or other the matter of air hose was not covered.

President Morris: This is something we are all interested in and something that is apt to come up at any time, and all ought to be posted on the subject.

Mr. Showers: We have been bothered but very little with this matter, but at the same time I know it is customary not only to use second-hand air hose, but (I will add a little more to the statement made) there are cases where spliced hose have been applied and bill made. It is an imposition upon the owner. In my judgment, I think such material should be used up at home, as bills are liable to be made through the clerical department not knowing whether second-hand material was used or not.

President Morris: Has your attention been called to any cases where they have charged you with a new hose and applied a second-hand one?

Mr. Showers: There have been a few cases. I had a case a short time ago where they applied a spliced hose and billed us for an air hose. When their attention was called to it they said it was the fault of the clerical department. As you do not discover this until bill is rendered, this causes considerable trouble.

Mr. Callahan: I did not understand Mr. Grieb; that is, whether they should be applied at all or not, or whether the price should be at 75 per cent as other second-hand material.

Mr. Grieb: I would say for the gentleman's information that the point I raised was whether the use of second-hand air hose should be allowed on foreign cars under circumstances allowing a bill under the existing rules—simply in those cases where a bill could be presented if the right kind of material had been used.

Mr. Hunt: Second-hand air hose or spliced air hose is rather an uncertain quantity. You can't tell much about it. They may last a long time and they may go to pieces the day they are applied; therefore, I think it would be better to apply new hose to our neighbor's cars. I think that they would rather pay the price of a new hose and have it applied, than to pay the second-hand price and have a second-hand hose applied. I think the car owner would be more benefited by having a new hose applied to his car.

President Morris: What is the custom in charging for spliced hose? Are they considered in the same class as second-hand hose? Some roads object to spliced hose altogether, where, perhaps, they would not object to second-hand hose at second-hand prices.

A Member: Is there a work card applied charging new material for old, or simply charging for a hose, not specifying whether new or old?

Mr. Showers: In response to that I would like to ask a question. Is there anything in the rules fixing the price for second-hand air hose? In addition, I will say that we bill for one air hose applied, and I think that most of the bills that are made do not state whether they are new or old. They just specify "one air hose applied" and give the cause as "removal." If there is any price for second-hand air hose it is something I have not discovered.

President Morris: I believe the rules do not specify a price for second-hand air hose.

Mr. Groobey: I think at the last meeting of the Western Railway Club that the subject of spliced hose came up, and it was stated by the roads that took part that it was not intended to apply spliced hose to foreign cars at all; they simply prepared them for their own cars.

A Member: The rules state what second-hand material may be used on foreign cars. As I understand it, there is no mention made of hose in that section;

therefore, I think that second-hand hose should not be used on foreign cars.

Mr. Grieb: I agree with the gentleman. I favor the idea that none but new hose should be applied to foreign cars; but I cannot agree with the course of his argument. That would exclude the use of second-hand bolts, oil boxes and arch bars, which, while they have seen a previous service, are always charged as new, they being as good as new. I would like to hear as to whether a road can charge for second-hand air hose under conditions that make such charge allowable under the M. C. B. rules. If they acknowledge that the hose was good, though second-hand, they should state on their repair card it was second-hand. But the price charged in bill accompanying it charges that same hose at the price fixed for the hose new.

Mr. Jones: I don't know that we apply second-hand hose. If I should get a car with a repair card on it, I should return the car.

Mr. Smith: I move that the sense of this meeting be that only new air hose be applied to foreign cars.

Motion seconded.

Mr. Krump: I would like to ask what you would do in a case like this. We often find a bad gasket in a hose on a car made up in a train and don't have time to go and get a gasket and put it in, so we put on a new hose. Now we can't charge for the new hose which we give to the car owner and get an old hose in its place.

Mr. Stuckie: The practice on the Atchison when we have a case of that kind is to get a good serviceable hose for the one we remove. Some roads charge for the gasket.

The motion put by Mr. Smith was here put and carried.

#### Miscellaneous Business

Upon motion of Mr. Sharp it was voted to appoint a committee to draft resolutions of thanks to Proprietor Eden of the Great Northern Hotel, for the courtesies extended in the way of a meeting room, etc. The following were appointed as such committee: Messrs. Sharp, Showers and Davis, Jr.

Upon motion of Mr. Callahan it was voted to appoint a committee to confer with the general managers with reference to securing a place of meeting for the association, and a permanent down town office for the secretary. The following were appointed as such committee: Messrs. Callahan, Hunt and Burnett.

Upon motion of Mr. Smith it was voted that the chair be instructed to appoint a committee of three on introductions, whose business it shall be to introduce strangers. President Morris left the appointment of this committee to some future time.

Upon motion of Mr. Groobey it was decided that the present committee on publication should be continued.

President Morris then announced that the executive committee for the following year, in addition to the officers, would be as follows: T. B. Hunt, P. F. W. & C.; S. Shannon, L. S. & M. S.; Wm. Gierhke, C. & E. The president then said: "I would like to say in connection with this that the executive committee meetings in the past year have not been a success in the matter of attendance, and I think it would be a good idea in notifying the several gentlemen of their appointment to ask that they give the meetings some little importance by going there and trying to do what they can to help the association along. Unless this is done we are apt to come to a standstill instead of going forward as we ought to."

After giving a vote of thanks to the committee of five who had charge of excursion of the day the association adjourned.

The programme for the next meeting, which will be held at the Great Northern Hotel at 2 p. m., Oct. 10, is as follows.

Discussion of Mr. S. J. Kidder's paper on "Air Brake Practice," which paper is published in full in this issue.

Discussion of a case in dispute between two members on a question of interchange. An outline of this case will be sent to each member by mail.

Topical Discussions—(1) "Should brasses changed account of removal of wheels for defects that owners are not responsible for, be charged to owners?"; (2) "What is the customary practice as to treatment of hot boxes on freight cars by train men on the road. Should a cooling compound be used?"

#### The Excursion Over the Belt Line.

It will be remembered that the association had planned for a trip over the Chicago & Western Indiana Belt Line to occupy the day prior to the regular evening meeting. Notwithstanding the inclemency of the weather this plan was carried out and proved an undoubted success. About 100 members and their friends participated in the excursion and at its conclusion voted that the day had been well spent.

The train, which consisted of a Chicago & Erie baggage car and two coaches, left Dearborn Station at 9 a. m. and went directly to the Chicago & Northwestern shops, at West 40th street. Here the party was cordially greeted by Mr. Robert Quayle, superintendent of motive power, and by Mr. C. A. Schroyer, superintendent of car department of the Northwestern road. These gentlemen escorted the party through the vari-

ous departments of the shops and described the numerous features of interest examined. Among the features that especially engaged the attention of the party were the diversified uses to which compressed air was applied. It was noticed that a great amount of labor-saving was accomplished by the use of air in the handling of wheels, mounted and unmounted. It was noticed, also, that air was used in connection with gasoline for the burning off of paint from passenger cars, and for the melting off of old solder from the seams of passenger car roofs, leaving the seams in perfect condition for resoldering, thus avoiding all scraping of seams. A very ingenious staging for use in painting the outside of passenger cars was also noticed. This staging consisted of stationary posts fitted with movable brackets so arranged as to swing around to clear when not in use. The staging was counterbalanced so that one man could readily adjust it to any position required. The transfer table had electricity as a motive power, a surface trolley being used. This appeared to be a very neat arrangement and seemed to be a decided improvement over the overhead trolley. The wire was enclosed in a box or trough. Oil was found to be used exclusively as fuel for the boilers in the power plant and for furnaces in the blacksmith shop.

After a thorough inspection of these shops had been made the party returned to the cars at 12 o'clock and the train started for the Illinois Central shops at Burnside. On the way lunch was served in the baggage car and was found to be very satisfactory. This feature of entertainment was arranged by Mr. F. W. Getty, superintendent of sleeping and dining cars of the Chicago, Milwaukee & St. Paul.

The Illinois Central shops were reached at 1:30 p. m. and the party was there taken in charge by Mr. F. W. Brazier, assistant superintendent of motive power, and Mr. J. W. Lintrell, master mechanic, of the Illinois Central. These gentlemen conducted the party over their very modern and completely equipped shops. One feature that attracted particular notice was the arrangement for natural light in the various buildings. The party also could not fail to comment upon the extreme neatness of the grounds and buildings as a whole. The car shops were well filled with cars in process of construction and undergoing repairs. The paint shop was found to be very roomy, and the arrangements for taking care of paint, oil, etc., very elaborate and extremely neat and clean. The shops are heated by the hot air system.

At about 3 o'clock the party left for the Illinois Steel Company's works, at South Chicago, and upon arrival there was met with an official and escorted over the grounds and through the mills. The manufacture of rails and sheet steel was followed through the various processes from the ore to the finished product. These processes were particularly interesting to the majority of the party, many of whom had never before witnessed anything of this nature.

Departure for the city was made at 5 p. m. and nearly all the party attended the regular meeting in the evening at the Great Northern hotel. It had been the intention to stop at the principal interchange points on the Belt Railway but on account of the heavy rain this was found to be impracticable.

#### COMMENT BY CAR FOREMEN.

This column is edited by the Publication Committee of the Car Foremen's Association, and the RAILWAY MASTER MECHANIC is not responsible for any of the views expressed therein. Communications and items of interest to car men are solicited. T. R. Morris, chairman.

#### Consolidation of M. C. B. and M. M. Associations.

The proposed consolidation of the Master Car Builders' and the Master Mechanics' Associations is a question that has vital interest for the car men of this country.

It is to be hoped that the movement has not yet reached that stage, where, as has been claimed, the merging of the associations is a foregone conclusion.

No one will attempt to deny that the work of the Master Car Builders since the time of organization, has been of incalculable value to the railroads of this country, and to relegate these officials to the rear at this time seems to be rank injustice. While this is an element that perhaps should not be considered, there are many others which have a greater bearing. Has the M. C. B. Association accomplished its work? If so there is no longer an excuse for its existence. Can, or will, the master mechanics take the same interest in car matters that the master car builders do?

A superintendent of motive power is first and foremost a locomotive man. It requires a peculiar training to fit a man for the responsible position of master car builder as it does for that of master mechanic and a lack of that training means that either department will suffer.

So far as interest and attendance in the conventions of these associations is concerned, the master car builders take the lead, and if there is to be a consolidation why should not the most important one control and the master mechanics be made subordinate to them?

#### Sect on 20 of Rule 3 Again.

The action taken by the car foremen at their meeting in September on the construction to be placed on the above section, especially wherein it concerns worn-out brake shoes on cars offered in interchange, seems to be indorsed by a number of officials of lines centering in Chicago.

Evidence of this is shown by the fact that a number of the roads having terminals here have arranged with one another to pass cars back and forth between their respective roads, leaving it to the receiving line to decide whether shoes should be removed or not, the latter to charge owners in case it is decided in the affirmative and the work is done.

This seems to be the only rational way to handle this section, and the practice should be adopted universally. It expedites the movement of cars, saves clerical work in reducing the number of requests for defect cards, puts the expense of replacing worn out shoes on the owner (where it belongs) and, in fact, simplifies and straightens out matters generally. It is difficult to see what arguments of any merit whatever can be brought against this arrangement.

Further, it appears to be a subject worthy the attention of the arbitration committee of the Master Car Builders' Association. Previous cases that have been ambiguous in meaning, and which have caused disputes, have been settled by the committee's decisions, which were published in leaflet form and generally distributed, resulting in a uniform practice, greatly benefiting all concerned.

Would it not be well for the members of the committee to consider this?

#### Communications.

##### Responsibility for Worn Out Brake Shoes. October 14, 1898.

To the Editor:

Replying to Mr. Valentine's article of Sept. 14 in the matter of responsibility for worn out brake shoes, in which he scores the Car Foremen's Association of Chicago for having entered into a mutual agreement not to ask for defect cards from each other for worn out brake shoes on cars offered in interchange, covered by Section 20 of Rule 3:—

I think Mr. Valentine is unnecessarily severe in his criticism, and makes some statements which are not in accordance with the spirit displayed at the meeting in which the above action was taken. In the first place, Mr. Valentine interprets the mutual agreement referred to as a resolution to ignore the rules. This assumption is not warranted by the facts. When the question was brought up it was leisurely and thoroughly discussed, both pro and con, and the resolution was adopted by an almost unanimous vote.

No one could be found who volunteered an excuse for the existence of the rule which held delivering me responsible for a car delivered with a worn out brake shoe. Mr. Valentine questions the right of this association to formulate agreements under the M. C. B. rules that will expedite the movement of cars and best serve the interests of all roads centering into Chicago. I do not think there is one who will deny that the M. C. B. rules as revised at Saratoga in June, 1898, are the best that we have ever enjoyed, nor do I think that we should be quite so orthodox as to maintain that these rules are not subject to slight improvement. The action of the Car Foremen's Association thus far illustrates that there are some minor points in the rules which, if literally adhered to, would defeat the object of the framers of the rules as outlined in the preface—namely, that car owners are chargeable with the repairs to their cars necessitated by ordinary wear and tear in fair service. The parties interested know that the action taken by the Car Foremen's Association is fully endorsed by their superior officers, and that railroads not represented in this association are even now entering into the same agreement.

I am unable to find from the proceedings by whom the rule to hold delivering lines responsible for worn out brake shoes was introduced, nor have I found anybody who could give cause for its existence. The only reason apparent seems to be to give the receiving line the prerogative to demand card for such worn out parts, if it were found desirable to do so; either on account of their not having suitable material for repairs, or if an undue number of cars in such condition were being foisted upon them. This prerogative the roads entering Chicago, represented by the Chicago Car Foremen's Association, have agreed amongst themselves to waive, having sufficient confidence in each other to believe that no undue advantage of this nature will be taken. It seems to me that the parties introducing this provision in the M. C. B. rules have striven to make a fine point, which the men represented in the association do not consider necessary nor practical.

The point I wish to lay particular stress upon is that the Car Foremen's Association has not attempted to ignore the rules. We simply desire to enter into such an agreement under the rules as will prove of mutual interest and expedite the interchange of cars. Its right to do this should not be questioned, as I think

there is no one who would claim that parties interchanging at any particular point should not be allowed the privilege of doing so on record instead of demanding defect cards. I would like to know what Mr. Valentine has to say about the agreement entered into by the Chicago roads, which was known as the New Interchange Association, which contemplated an entire revision of the M. C. B. rules, and which, after two years of trial, was pronounced satisfactory and adopted by the Master Car Builders' Association in lieu of its own code. Mr. Valentine's remarks cast a serious reflection on the action taken by the Foremen's Association, and as they seem unwarranted, I hope you will insert these remarks in your column headed "Comments by Car Foremen." J. C. G.

#### SUPPLY TRADE NOTES.

McLeod & Clark, of Cincinnati, Ohio, recently contracted for the sale of a large number of their Buckeye portable torch lights to the British government.

The Chicago Grain Door Company has received an order for grain doors and security lock brackets for the 500 Soo Line cars building at Wells & French Company.

The Carbon Steel Company, of Pittsburg, Pa., is furnishing a special oil-treated steel for the boilers and fire boxes of eight Oregon Short Line 10-wheel locomotives.

The Warren (Mass.) Steam Pump Company recently received orders for two 10x16x18 horizontal air pumps and two No. 5 boiler feed pumps for the Norfolk & Southern Railway.

The Detroit Railway Supply Company has been incorporated, with headquarters in Detroit. It will enter the business of manufacturing general railway supplies. The incorporators are H. D. Miles, W. P. Harris, R. M. Brady and F. S. Harris.

The Safety Appliance Company, Ltd., are equipping all the coaches and baggage cars of the Dayton & Union Railroad, Dayton, Ohio, with their "Brake Equalizer" and "Dead Lever Take-Up," and during the past month they have received orders to equip over 900 cars.

The Schoen Pressed Steel Company, of Pittsburg, finds its capacity for the production of steel cars, which equals about 150 steel cars per week, to be fully engaged for a considerable time to come. It is receiving inquiries from all over the world concerning the costs, capacities and details of construction of steel cars.

The Pearson Jack Company, of Boston, has recently placed its ratchet jack upon a large number of roads, including the Union Pacific, Wabash, Wisconsin Central, Northern Pacific, Norfolk & Western, Oregon Short Line, Lake Shore & Michigan Southern, Elgin, Joliet & Eastern, New York, Ontario & Western, and International & Great Northern Railways.

The Hilles & Jones Company, of Wilmington, Del., recently shipped a set of plate bending rolls, capable of bending  $\frac{3}{4}$ -in. plate 12 ft. wide, to the Oregon Short Line. This company also recently shipped one of its No. 4 combined punches and shears, with 14 ins. depth of throat on each side, to the Cleveland shops of the Lake Shore & Michigan Southern Railway. This machine is to be used specially on heavy car work.

The C. H. Haesler Company, of Philadelphia, has recently sold large numbers of improved pneumatic drills to the Baldwin Locomotive Works, to the Newport News Ship Building and Dry Dock Company, and to the Cramps Ship Building Company. The same company has recently supplied a complete pneumatic plant to the Brooklyn Navy Yard, and also a number of tools to the Port Royal and Mare Island yards.

An interesting exhibition of pneumatic riveting was recently made at the shops of the Boyer Machine Company, of St. Louis, for the benefit of attendants at the convention of the American Boiler Manufacturers' Association. The riveter used weighed 140 lbs., and had a piston  $1\frac{3}{4}$  in. in diameter, by 6 in. stroke. With this machine  $1\frac{1}{4}$  in. rivets were driven through  $1\frac{1}{2}$  ins. of metal in from 10 to 15 seconds of actual hammering.

The property of the Boyden Air Brake Company, which was some months ago bought by the Westinghouse Air Brake Company, has been transferred to the latter. This transfer arose out of a decision of the United States supreme court upholding the validity of the Boyden patents. It is understood that the consideration for the transfer is \$900,000. Mr. Geo. A. Boyden has, we understand, accepted a position with the Westinghouse Company.

**WANTED**—To know where a steam railroad or trolley line is wanted and will pay. Address B. C. Davis, Att'y. 156 Remsen street, Brooklyn, N. Y.



# RAILWAY MASTER MECHANIC

WALTER D. CROSMAN, Editor.

EDWIN N. LEWIS, Manager.

PUBLISHED MONTHLY BY

THE RAILWAY LIST COMPANY.

Devoted to the interests of railway motive power, car equipment, shops, machinery and supplies. Communications on any topics suitable to these columns are solicited.

Subscription price \$1.00 a year, to foreign countries \$1.50, free of postage. Advertising rates given on application to the office, by mail or in person. Address

THE RAILWAY LIST COMPANY,

315 Dearborn St., Chicago, Ill.

*The Official Railway List is published by this Company.*

Vol. XXI. CHICAGO, DECEMBER, 1898. No. 12.

THE offices of the Railway Master Mechanic have been moved from the Rookery building to 315 Dearborn street, where, in room 1308, they are more conveniently and commodiously housed. The location is very convenient for visitors, being more centrally located with reference to the railway and railway supply offices of the city.

A SUGGESTION that should be heeded by passenger car designers and builders is made in our car foremen's department this month, viz.: that the work of car repairers should be borne in mind when designing cars. The writer develops the fact that only too frequently our modern traveling palaces are so built that the car repairer meets with the greatest difficulty in getting at his work. The point merits careful consideration.

A PIONEER in the development of the locomotive has passed away, in the person of Mr. Robert Sinclair. This man strongly marked his impress on the early history of the locomotive. From a brief account of his work given in another column of this issue it will be seen that he is credited with having introduced, in England, the conical locomotive stack and the Bissell locomotive truck, and with having been one of the first to use steel for locomotive details, to use injectors on locomotives, to work to standard patterns and gages, to provide ample bearing surfaces for valve gear, etc., to provide suitable cab shelter for enginemen and to experiment with roller bearings for car axles (which latter, by the way, he abandoned). An exhaustive history of Mr. Sinclair and of his work would be of great value to the student of locomotive design, and we hope that it may be written.

THE value of exhaust steam as used for heating water in locomotive tanks is not accurately determined. As we said last month Mr. Barnes, on the Wabash, claims a saving in fuel of 10 per cent by carrying the air pump exhaust to the tender by his method. On the Northern Pacific (whose similar appliance we illustrate in this issue), no definite claims are made. Mr. Herr, formerly superintendent of motive power of the latter road, said at a recent meeting of the Western Railway Club, that his understanding of the theoretical case was that for every 11 degrees of increase in temperature of feed water a saving of 1 per cent in fuel should result, and further that he had found an injector that would handle water up to 124 degrees. But he made no estimate of the saving made on the Northern Pacific. It would be well if careful tests could be made to get at some determinate figures on this matter.

THE subject of trains parting has finally come to be recognized as one of very great importance. It will be remembered that it was suggestively reported upon by a Master Car Builders' committee in 1897, and that it received a good measure of attention at the last Master Car Builders' convention, even though the committee to which it was assigned had no report. This year's committee has now taken the matter up in earnest and we give its circular of inquiry elsewhere in this issue. It will be seen that

a very wide range of information is sought, and that the committee has evidently very carefully thought out its proposed line of work. If answers are systematically prepared, by even a few of our larger railway systems, the committee will have material upon which to have a very thorough report. It should be able to so clear up the ground that the field would be fully prepared for the standing committee on the subject which Mr. Waitt last June urged should be appointed.

COMMITTEE work has commenced in earnest for the season, as is evidenced by the circular of inquiry given in another column—the first circular, we believe, of the year. Long years of experience have shown that "circulars of inquiry" are not answered as fully or as promptly as they should be, and it is the ever present duty of all interested in the associations to exhort the slow and the indolent and the neglectful to do their duty in the way of aiding committee work. Answers to circulars of inquiry are not of course the sole dependence of committees, but they may, by prompt and thoughtful preparation by association members, be made a tremendously big help. Some topics, in fact, are such in nature that the answers to circulars are absolutely essential to the proper development of the subject in the report. The trains parting committee work, for instance, must in the nature of things, lie almost wholly in a study of varied practice and experience that can be known only through success in getting response to circulars of inquiry.

AT A recent meeting of the Western Railway Club a remark was made by Mr. Rhodes which seems sufficiently important to be emphasized here lest it may have escaped the attention of many persons who should bear it well in mind. It was to the effect that locomotive ash pans should be so constructed as to provide the quickest and safest methods of removing the refuse from the pans. It is desired to emphasize the word "safest" because there is a tendency to overlook this requirement. Formerly it was quite common to provide openings at the sides of the pans so that the cleaner could hoe out the refuse while he stood entirely outside of the wheels, but in general now it is necessary for the cleaner to get under the locomotive to do the work because the only openings provided are at the ends of the pans. This requires that he place himself in a very dangerous position and, unless the locomotive is standing over a pit, one in which it is very difficult for him to perform his duties. It is believed that arrangements much safer than the present general practice can be made and that such arrangements may result in expediting the work to be done.

## REVIVING OLD DESIGNS.

THE old saying that "History repeats itself" is used just as frequently, probably, when referring to the reappearance of railway devices as when referring to any other particular class of devices or acts, and too frequently it is used with a semblance of a sneer. The reappearance of an old idea, even though in a new dress, is too apt to be cast aside with the remark that the thing was "tried years ago."

Those who have followed railway equipment for years are frequently brought in contact with revivals, sometimes survivals, of devices or methods which have been called to their attention at more or less extended intervals during their railway careers. But it is a decidedly mistaken position to take that because something was not suited to some particular service a number of years ago it is not worthy of consideration at the present; conditions may have changed, or the device may have been improved in such a way as to make the thing very timely.

The extended smoke box fought hard for existence, but finally came into very general use—and now there seems to be a decided tendency to cut it off. This does not mean, necessarily, that at the time the long smoke box came into general use it was not better than the short one, simply because there is a tendency now to cut it off, nor even though some roads did continue to use the short end; nor does the present tendency to a shorter box substantiate, alone, such position. The changes which the other parts of the locomotive are continually undergoing may have made it advisable to use now a shorter front end.

This leads up to the point which it was intended to make that, before passing judgment on a device or arrangement and passing it with the remark that, "it is old," the much better plan is to consider what

changes may have been made in the mean time in other co-related parts which might affect the one directly under consideration. In the example taken, changes in the valve gear or in the valve itself may have resulted in prolonging the effect of the exhaust on the fire or in reducing the sharp, quick effect to such an extent that it is advisable to cut off the extended front end and by so doing remove considerable weight from the engine truck without seriously affecting the effect of the exhaust on the fire. This example is taken not because it is the most pronounced, but because it was the first in mind that could be used to the point which it was desired to make; there are many other cases and many of them will appeal, perhaps, more strongly to different individuals.

## THE PURCHASE AND INSPECTION OF RAILWAY SUPPLIES.

The above was the subject of a paper read by Mr. H. B. Hodges at the October meeting of the New York Railroad Club, and in referring to the paper in these columns it is not with the intention of criticizing so much as with the intention of showing the application of some of his remarks and to show also that the rules, if they may be so called, as laid down by Mr. Hodges should not be followed blindly.

The position is taken that the ultimate, if not the initial, economy of buying only the best quality of material justifies a uniform practice in this regard, but Mr. Hodges wishes this idea qualified to the extent that when the cheaper article fulfills the purpose as well it is best not to purchase the more expensive one. But it is just here that the question arises as to who is to determine whether the cheaper material will do as well.

If the purchasing agent has developed from the engineer of tests, the experience gained in the latter position will frequently dictate to the purchasing agent what decision to make, and this will be true for a longer or shorter time, depending upon circumstances, after the duties of the testing department have been relinquished for those of the purchasing department, or they may continue indefinitely if the two departments are consolidated under one man. It is very doubtful whether one man could, with entire satisfaction, fill both the position of purchasing agent and of engineer of tests on the very large systems now common, but were it possible, such an arrangement would well equip the purchasing agent to decide in many cases whether a cheaper material would fill the requirements with as much satisfaction as a more costly, or better quality, material. On the other hand, if the purchasing agent relinquishes the duties of the engineer of tests it must be only a question of time when he will become less competent to judge of the fitness of various kinds of material for different requirements, the length of time depending upon his efforts to keep informed as well as possible on such questions as usually arise in the testing department, and also upon the changes occurring, almost daily, in the method of manufacturing.

The above arguments demonstrate, in a general way, that the purchasing agent should be, so far as the selection of quality is concerned, an agent of the one who is responsible for the service obtained from the material, unless the purchasing agent has authority also over the testing department; under the latter conditions he is in a position to advise what should be purchased and what should not be purchased, but it is extremely doubtful if even the engineer of tests should dictate what should and what should not be purchased. It will be the same with this as with other questions arising between different departments of railroads; if there is in mind always the best interests of the road and that is done which best conserves such interests, even though one department is favored at the expense of another, there will be little left for improvement.

There is one way in which the needs of the various users can be satisfied through the purchasing agent without making that official a "price clerk" and the method is meeting with much success. The officer who is responsible for the service given by the material should be the best informed concerning the requirements and should know also something about the methods followed in the manufacture of the same and how far those methods might affect the product; with such information it should be possible to formulate specifications which when filled would give material suited to the requirements. With such specifications drawn sufficiently close to insure the material wanted and not too close to shut

off competition, the purchasing agent should have a free hand to buy wherever the most favorable price could be obtained. It will be safer, generally, to make such specifications follow very closely the conditions met in service and then a fulfillment of the specifications should be insisted upon.

One of the most objectionable qualities of material purchased by railroads is that which is "just as good" as something which has been giving satisfaction, and the "just as good" assurance, when accompanied with a slight "shading" of the price, has caused much friction between the purchasing and the other departments and has raised the generally false impression that the average purchasing agent is not much of a judge of quality. Under such conditions it may not be surprising if the question is raised whether it is safe to allow the average purchasing agent the discretion of buying the "best."

There is a feature of the question of buying supplies which is too often not considered, that is the amount of the waste, and it will be found sometimes that although a good quality of material might give a somewhat longer service, yet the cost of the waste, which would be the same for good or bad material, might be sufficiently reduced when the poorer material is used to more than repay for the extra replacements necessary when such material is used.

Reference was made in the paper under discussion to the yearly records made in the purchasing department; this comparison, surely, should not be necessary unless the purchasing agent is entirely responsible for the quality of the material to the extent of saying what shall be purchased. Each department should be held separately responsible for the cost both for material and labor for operating the department and the head of the department will then interest himself to learn what is being purchased for him and what the cost may be, and it will then be necessary for the salesman to approach the man who is in the best position to judge quality and service, with the inducement of "just as good."

**DUTY TO INSPECT FOREIGN CARS APPLIES TO ALL THOSE HANDLED.**

That it is the duty of a railway company to use reasonable care to see that the cars employed on its road are in good order, and fit for the purposes for which they are intended, and that its employes have a right to rely upon this being the case, as also, that this duty of a railroad, as regards the cars owned by it, exists likewise as to cars of other roads received by it, sometimes designated as foreign cars, the supreme court of the United States pronounces settled.

But it was proposed, in the recent case of the Texas & Pacific Railway Company against Archibald, to limit this general duty of reasonable care as to the safety of its appliances resting on the railroad by confining its performance to such foreign cars as are received by a railroad "for the purpose of being hauled over its own road;" in other words, the proposition was that, where a car is received by a railroad for the purpose only of being locally handled, the railroad, as to such local business, is dispensed from all duty of looking after the condition of the cars by it used, and may, with legal impunity, submit its employes to the risk arising from its neglect of duty, says the court.

The argument in support of this contention, the supreme court, however, declares, wanted foundation in reason, and was unsupported by any authority, in reason, because, as the duty of the company to use reasonable diligence to furnish safe appliances is ever present, and applies to its entire business, it is beyond reason to attempt by a purely arbitrary distinction to take a particular part of the business of the company out of the operation of the general rule, and thereby to exempt it, as to the business so separated, from any obligation to observe reasonable precautions to furnish appliances which are in good condition.

**CORROSION OF IRON AND STEEL.**

Prof. R. H. Thurston, of Sibley College, sends an interesting communication concerning the relative corrosion of iron and steel to the Engineering News. He says:

Years ago, I endeavored to secure reliable and sufficient data on the subject to serve as a guide in practice. I found very little available material. There should be to-day much more, now that the use of steel has come to be general in all departments of engineering. The results of my researches in technical literature and reports are published in Sec. 192, Vol. II., of my "Mate-

rials of Engineering," page 328, et seq. In brief, they were:

- (1) Corrosion can ordinarily only occur in the presence simultaneously of oxygen, moisture and carbon-dioxide (Calvert).
- (2) The gases of the locomotive accelerate corrosion by their peculiar acid quality, arising from their contents of sulphur-oxides, iron and steel absorbing acids somewhat greedily (Kent).
- (3) Cast iron, in dilute solutions of acids, is rapidly acted upon, especially in warm water—in the flow of water of condensation, from engine condensers, for example—losing the metal, and often leaving the carbon and other matters: the piece retaining its form and general appearance unchanged, but with enormously reduced density. The metal is said by the uninformed to have been "changed to plumbago" (Calvert).
- (4) Corrosion is rapidly effected with cast metal irregularly and quickly cooled in the mold, less rapidly where slowly and regularly cooled (Mallett).
- (5) The rate of corrosion is ordinarily constant over

**FEED WATER HEATER—NORTHERN PACIFIC RAILWAY.**

On the Northern Pacific Railway there has been in successful use for some time—about a year, we believe—an arrangement for heating the feed water in the locomotive tank with the exhaust steam from the air pump. This arrangement is the subject of the accompanying illustration. It is, in effect, an adaptation of the arrangement devised by Mr. J. B. Barnes, Superintendent of Motive Power of the Wabash Railway, which we briefly described in our issue of April, 1897, page 49. Before proceeding with a description of the Northern Pacific arrangement, we may say that Mr. Barnes carries the exhaust back to the tank through a 1 1/4 in. pipe. Upon reaching the tank the exhaust passes into a 2 1/2 in. pipe, which extends around the bottom of the tank, from which pipe extend 15 vertical pipes

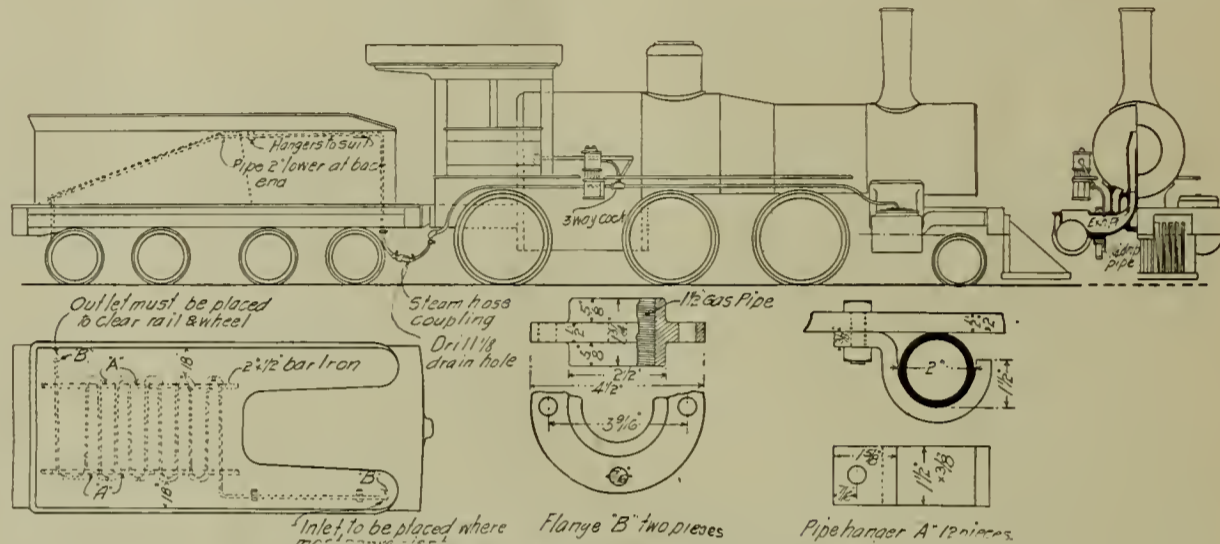

FEED WATER HEATER—NORTHERN PACIFIC RY.

long periods of time; but the removal of the rust retards oxidation, as it destroys the voltaic couple composed of metal and of oxide.

(6) Hard iron, rich in combined carbon, rusts slowly. The presence of graphite or of a different quality of iron in metallic contact with it, increases the rate of oxidation—presumably by forming local voltaic couples. Hard steel rusts less rapidly than soft.

(7) Foul sea-water, as the bilge water of a ship, corrodes iron and steel rapidly.

(8) The rate of corrosion is too variable to be stated in exact terms. The hulls of iron ships have been found to average a rate of not far from 1-16 inch in 25 years, when carefully painted. Iron roofs exposed to smoke and gases of locomotives are sometimes ruined in three or four years.

(9) The observations of Thwait are as follows: The time of endurance in years may be expected to average about:

$$T = \frac{W \times C}{L}$$

where W is the weight of metal in pounds per foot length of the member, L is its length of perimeter, inside and out, if hollow, and C is a constant, which has the following values, and the magnitude of which measures the relative loss by corrosion.

Material.	Water.			River.	Im- Clear or pure air.
	Sea.	Foul.	Clear.		
Cast iron	.0656	0.0636	0.0351	0.0113	0.0476
Wrought	.1956	.1255	.1440	.0123	.1254
Steel	.1944	.0970	.1133	.0125	.1252
Cast iron, no skin.	.23	.0880	.0728	.0109	.0854
Galvanized	.09	.0359	.0371	.0048	.0199

Average for sea water: Cast iron, in contact with brass, copper or gun bronzes, 0.19 to 0.35; wrought iron, in contact with the same, 0.3 to 0.45.

This is for unpainted metal, of course. For painted iron or steel it is safe to multiply the endurance, as above, by two or more.

The precision of the above figures would seem to indicate accurate measurements, and to settle the question as respects the various metals; but, unfortunately, the quality of the steel and the influence of varying proportions of carbon remain unmeasured, although soft and hard steels were compared with variable results. It has been assumed by the writer that the very softest steels, which contain less of the hardening elements than common iron, would oxidize more rapidly and the harder steels less rapidly, than wrought iron while the rate of corrosion of wrought iron is subject to great variation with the variation of the chemical composition, and the mechanical structure, of its always heterogeneous mass. Graphite in cast iron, and cinder in wrought iron, make with the adjacent metal rather effective voltaic combinations, and may be assumed to thus influence greatly the rate of corrosion.

tipped with goose neck vents. A valve operated from the cab diverts, in Mr. Barnes' arrangement, the exhaust to the stack when the tank water is sufficiently heated

It will be seen that the Northern Pacific arrangement differs in several essentials from that on the Wabash. The pipe in the tank is taken immediately to the top thereof and is carried back about half way, with a slight drop of 2 inches. It is thence zigzagged backward and downward until it reaches an outlet placed sufficiently far to one side to clear the rail and the wheel. It will accordingly be seen that there is no actual discharge of the exhaust into the water of the tank—thus removing the necessity for the oil separator used on the Wabash. It will also be noticed that the pipes in the tank are put in slanting, so that, as the water in the tank lowers there will be less surface of the pipe exposed to the cold water. In this way excessive heating is provided against. We have heard of no trouble arising with this arrangement in the way of so excessively heating the water as to interfere with the proper working of the injector. From the three-way cock operated from the cab to divert the flow of exhaust from the tank when the water in the latter becomes sufficiently heated, leads a pipe to the forward end of the engine, where the exhaust steam enters the locomotive exhaust passage, as shown, instead of entering the stack in a separate pipe through the smoke arch.

At a recent meeting of the Western Railway Club Mr. E. M. Herr, lately superintendent of motive power of the Northern Pacific, testified that the exhaust could be used to heat the feed water with entire success under certain conditions. He referred to the device which we have just described, and went on to give some account of its workings, as follows: "When the tank was full, of course the water came in contact with more heating surface and more heat was absorbed by the water. If the engineer ever did get caught with water so hot he could not work the injector, it always occurred with the right-hand injector first, because the pipe went into the right side, entering near the feed valve opening. In such a case he can always readily start the left-hand injector, because in the left leg of the tank there is no heating pipe, and there is a considerable reservoir of cold water which can be used in an emergency and to supply cold water enough to be used by the left injector until the next water station is reached. I was surprised to find



"Mr. Sinclair's position as the head of important railway works adjoining the metropolis naturally brought him in contact with a large number of inventors and introducers of novelties who wished to more or less revolutionize railway practice. To inventions containing promise he was always ready to give consideration, while, on the other hand, he was able to effectively relieve himself of the attentions of the mere 'faddist.' Amongst many things to which he gave attention was the use of roller bearings for railway vehicles, and now that the use of roller bearings in many forms has become so general, it may be interesting to note that during the early sixties the up morning express train from Ipswich to London and the corresponding down train in the afternoon were run for months with roller bearings fitted to all the axles with the exception of those of

FALSE VALVE SEATS.

BY FRED. E. ROGERS.

A locomotive valve seat an inch or an inch and a quarter high, with a properly balanced valve and which always has a just proportion of good lubricant, ought to last as long as it is practicable to keep the whole structure in running condition.

It is a fact, however, that many locomotives which have been in commission for only a few years are in a condition so that it is a question of either false seats or new cylinders.

While it is not necessary to go over the various causes which lead to this undesirable condition, the importance of always having a slight blow attended to, as soon as noticed, cannot be overestimated.

which they are fitted. It does not require much of this treatment before the man in the cab discovers that he has hived a swarm of bees in the stack, and now is the time to have the matter attended to or his valve seats will be worn more in a month than they ought to be in a year.

A blow of this sort has the peculiarity of dragging with it the greater portion of the oil fed through the lubricator, so that when this condition is reached it aggravates itself and the oil account begins to be a nightmare to the unhappy runner.

When, however, the seats have been nearly worn down by neglect or otherwise to the surface on which the steam chest joint rests, the question of false seats or new cylinders looms up.

The experience of many is that it is a question

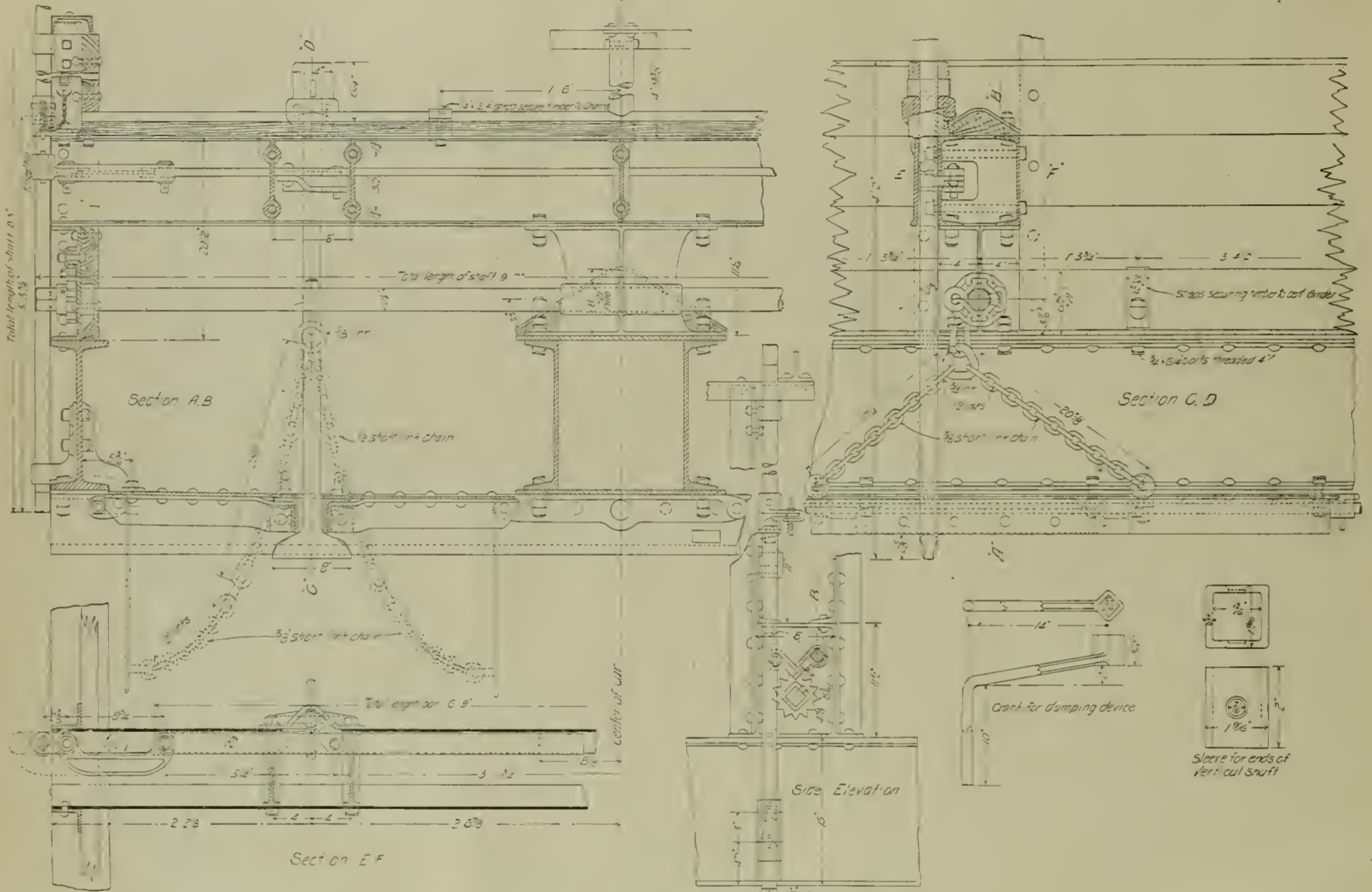

DROP DOORS FOR N. P. 100,000 LBS. STEEL COAL CAR.

the guards' vans. Notwithstanding much trouble in trying various forms and materials for such bearings, however, they could not be made sufficiently trustworthy for extended use, and ultimately they were abandoned."

DROP DOORS FOR NORTHERN PACIFIC 100,000 LBS. STEEL COAL CAR.

In our issue of October, 1898, we gave quite full illustrations of the 100,000 lbs. capacity steel coal car built for the Northern Pacific Railroad, as designed by Mr. E. M. Herr. We now give the full details of the drop doors and the arrangements for operating the same. As the drawings are very complete and are reproduced so clearly, but little description is needed. It will be noticed that the suspension rods are connected in pairs by a rod inclosed between the cross channels. This horizontal rod is connected in turn to a vertical shaft on the side of the car so the door may be unlatched either from the ground or from the top of the car. The suspension rods have helical planes at the tops which assist in overcoming the friction of the crow feet at the bottom. The doors are closed by winding the chains on the shaft. The doors are made of 1 1/4 inch plate reinforced with angles, and their hinges are of cast steel and bolted to the under frame.

There are many forms of balanced valves in use—good, bad and indifferent—any of which will resent bad treatment, and the result is always cumulative; that is, the condition which brought on a slight blow is aggravated by the balancing rig itself.

To illustrate, the Richardson balance, which is probably used in this country to a greater extent than any other, will be taken. As is well known, it consists of a rectangular space on top of the valve inclosed by thin packing strips of cast iron held up to the planed surface of the steam chest cover by flat springs. This space communicates with the exhaust cavity by means of a half-inch hole drilled through the valve. This hole is for the purpose of allowing the small quantity of vapor, which will always work through with any balancing device in the best of condition, to escape, and thus avoid accumulating a pressure in this space equal to that in the chest around the valve. This hole will also allow a vast quantity of steam to escape if the packing strips become badly worn.

Now, if an engineer neglects his valves he not only starts a destructive wear on his valve seats but also on these packing strips, and as they are dragged back and forth by the valve, they resist with considerable force a change of direction of movement, with a consequent wear on the slots in

of the devil or the deep sea as far as expense goes. The new cylinder is expensive in itself and requires considerable time for fitting. The false seat, while inexpensive at first, proves in some instances to be very expensive in delays and repairs.

If a few points are observed in making and fitting false seats much trouble can be avoided, and although never as good as the original, they can be made quite durable and effective.

A seat of this kind should always be made as thick as possible; never tolerate one much under an inch in thickness, as they will warp and twist under the action of the valve. No attempt should be made to fasten them down by bolts or screws, as it invariably proves a snare and delusion.

The sketch shows the form of seat used on the Fall Brook locomotives and a description of the method pursued in fitting may be interesting. It is planed and slotted in the usual way so that it is a duplicate of the original, and then put in position on the cylinder with the chest on top and some of the studs screwed in place. The lugs A A A A are then scribed off to fit the inside of the chest. After these have been planed off closely to the lines the seat is fitted by the file to the chest, as shown by the dotted lines. Care should be taken to have it fit closely, but not tight enough to spring it out of shape.

A piece of cast iron of this shape and these dimensions is almost invariably slightly warped and out of true when the machine work is done, and so the practice is to file and scrape the under side to a surface plate before attempting to fit it in place on the cylinder.

The usual method of "spotting down" is followed, and after this a slight grinding with oil and emery is given. Here is where considerable care is required to avoid defeating the object sought, that is, a uniform hearing between the two surfaces.

After the first application of oil and emery the grinding should be continued not more than five minutes, when the two surfaces should be cleaned and the seat laid in place and tested by rapping for

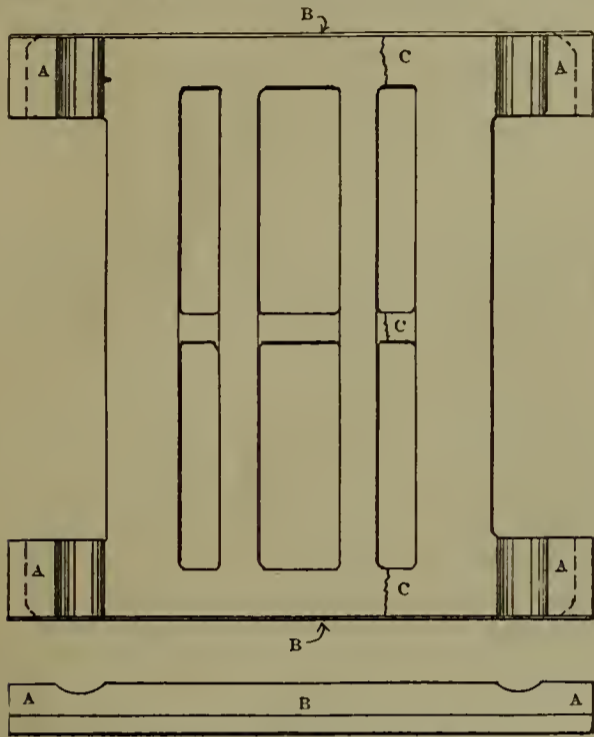

VALVE SEAT—FALL BROOK RY.

the hollow places. By judiciously scraping the high points and careful use of the emery in the places required the seat can be rapidly brought to a condition that when laid in position with no oil between the two, it will sound solid in all places. When this condition is obtained no doubt need be feared of its leaking as long as the valve remains in good shape.

Occasionally one of these seats will crack in two, as shown by the lines C C C. When this occurs there is a liability of the pieces raising up and catching the edge of the valve and thereby wrecking the motion work. To avoid this, the chest is planed with an undercut on the sides, corresponding to B B, and the seat has projections B B to engage with it, so that when in place the pieces cannot raise up and cause a wreck. Clearance is, of course, allowed so that the chest is not held off the joint by the projections.

**THE PURCHASE AND INSPECTION OF RAILWAY SUPPLIES.\***

The purchasing agent should be something more than a mere price clerk and medium of communication between the chief engineer or superintendent of motive power and the dealer or manufacturer; he should, before he is competent to hold this responsible position, become familiar with the different classes of supplies used in all departments, the service required of them and the peculiar uses to which they are to be put. He should furthermore post himself as to the different kinds and qualities of railroad supplies on the market, with which object some study of the processes of manufacture at the mills and factories is of great advantage, so that he may be able to select his supplies with some judgment, and not make the selection depend solely on price—frequently a very expensive practice in the long run.

No sensible man who has enough money to buy a pair of strong, well-made shoes for his own use, would for an instant think of purchasing a pair made of imitation leather with paper soles, knowing that they would not survive a single rainstorm, and that the money he would spend for shoes of this description in a year would be more than the cost of a good pair which would outlast all of the poor ones, and yet that same man would perhaps buy for the railroad supplies poorly made or of inferior material, merely because they were

\*Extracted from a paper read before the New York Railroad Club, Oct. 20, by H. B. Hodges, purchasing agent and superintendent of tests of the Long Island Railway.

cheap, no doubt conscientiously believing that he was acting for the best interest of his company. Of course the other extreme—buying an unnecessarily high grade of supplies at a correspondingly high price—is to be equally avoided, for it frequently happens that, for the special use to which the material is to be used, what for convenience might be called a "fancy" grade would last no longer and give no better practical service than one less expensive. It is here that the purchasing agent must rely on his experience and judgment, and upon buying on the basis of definite standards of quality, as shown by rationally constructed specifications or standard samples.

By "rationally constructed" specifications are meant those which require only what is essential for satisfactory and long service, and entirely within the power of the manufacturer to produce, without revolutionizing his processes of manufacture, putting in new and special machinery, etc. It would, for example, be foolish to specify for bar-iron used in general car-repairs, a grade possessing the strength and toughness requisite for staybolts, as this would greatly increase the cost of such repairs without any corresponding advantage in the way of increased life or better service, and it is therefore the practice of roads buying under specifications to require a higher tensile strength and greater elongation for iron to be used for stay-bolts, than where it is to be used in general repairs of cars. It would be equally absurd to require for hose used to convey water to the drinking tanks in cars the same quality of rubber and the same resistance to pressure that are required of air-brake hose. For this reason it is customary in hose specifications to have one set of requirements for water-hose and another for air-brake hose, so far as the quality of the rubber of the inner tube and the friction of the plies are concerned, and to divide each group in various subdivisions regulated by the diameter and number of plies according to the special uses to which the different classes of hose are to be put.

Furthermore, in order not to demand something which the manufacturers cannot furnish, it is desirable to consult with them before finally adopting and issuing specifications, and to submit to them the original draft for their criticisms and suggestions, and this method is frequently employed with mutually satisfactory results.

In many instances—probably in the majority of them—there is no intention on the part of the manufacturer or dealer to deceive the consumer in delivering goods which may reasonably be classed as adulterated. It is another application of the law of supply and demand. There is unquestionably a large demand for cheap goods, irrespective of quality, in all lines of trade, and it is perfectly right for the manufacturer to meet that demand, so long as he does not claim for these cheap goods qualities which he knows they do not possess, and as long as he is willing to acknowledge these products of his mills. The responsibility should fall on the purchasing agent who is willing to buy poor stuff because it is cheap, or who does not take reasonable precautions to ensure his getting supplies free from adulteration, and of the quality best suited to the service they are to undergo. To protect the railroad company, himself and the honest manufacturer, there is, to the best of my belief, but one method—that is, to specify in all cases where there is any room for doubt, just what quality of material is wanted and what kind of inspection and tests they are expected to pass, and then to provide for such inspection. Many of the largest roads in the country have a testing department or a corps of mechanical engineers, chemists and inspectors attached to either the supply or motive power departments, and a thorough system of inspection and tests.

Some of the smaller systems have one or two experienced men to make mechanical and chemical tests of the most important classes of material, and have their mill inspection done by outside firms of engineers. Still others have such work of this description as they have found almost indispensable done exclusively by these outside bureaus of inspection, and generally, I believe, with satisfactory results. Even if the management of a road does not see its way clear to maintain testing laboratories of its own, it can, at a comparatively small expense, have its material bought under specifications and have occasional tests and inspections made as a check on the quality of their supplies, and if the manufacturer is instructed to hold all material until inspected or until he is notified to make shipments, even if he were disposed to be lax in living up to the requirements of the specifications, it would be unwise for him to do so, knowing that he was liable to have any shipment inspected or tested on its arrival at its destination, and returned if not found up to the mark.

No engineer of a railroad would, I imagine, think for an instant of having a steel bridge constructed without specifying what he deemed requisite as to strength and workmanship and arranging for rigid tests to be made by competent inspectors representing the railroad and not the bridge manufacturer, and if this necessity is generally recognized in the case of bridge material, why not also in the case of axles, firebox steel, stay-bolt iron and wheels, as defective material or faulty manufacture is in these cases also likely to cause serious accidents, as well as the expense of renewals, which might be largely avoided or lessened by intelligent inspection? And this same argument applies to a greater or less degree to many other classes of materials.

If a wheel breaks in service and causes a wreck, of what consequence is the assurance that the maker will replace that wheel? He is not held responsible for the loss of life and of thousands of dollars worth of equipment, which might have been averted by preliminary tests, at the paltry cost of a single car wheel, by which the defective wheels, represented by the sample tested, might have been rejected, and therefore never have been put in service. Moreover, the system of buying only of firms of long-established reputation, because they can be trusted in the opinion of the buyer, does serious injustice to younger houses, equally honest and often turning out goods of equal quality. By adopting intelligent specifications, supported by a subsequent inspection, the purchasing agent can safely invite all respectable houses to compete for his business on an absolutely fair and impartial basis, and in this way he can safely give the order to the lowest bidder, knowing that he is protected by the tests to be made later.

In my opinion, the maker of high grades of goods is benefited by this system as much as the consumer. He is protected against the makers of inferior or adulterated articles who, in a competition based on prices alone, would get the business. The profit on high-priced goods is, I suppose, greater, as a rule, than on cheap ones and the only reason why a dealer should prefer to sell the latter would be the fact that the poorer goods would wear out so rapidly that the quantity sold would more than make up the difference—an argument which should induce the consumer to avoid buying them.

It frequently happens that the cost of labor in making renewals is so much greater than that of the material used that it is an economy to pay twice as much for material which will last twice as long as some other. Take, for instance, staybolts, and consider the following figures, representing actual practice on one of our large roads:

Average length of radial staybolts, 7½ in.; diameter, 7/8 in.; weight, 1½ lb.	
Cost of labor, removing and putting in new bolt.	\$0 20
Cost of bolt, at 6 cents a lb.	9
Cost of bolt, at 3 cents a lb.	4½
Cost of labor and material, removing old bolt and putting in one bolt costing 6 cents a lb.	29
Cost of labor and material, removing two bolts and putting in two bolts costing 3 cents a lb.	49

The above figures are based on the assumption that the 6-cent iron will last twice as long as that costing 3 cents, and if this assumption is correct, as it doubtless is in the case of some of the cheaper grades of iron, the use of the better grade shows a marked saving, due to the labor saved by making renewals only half as often with the good iron as with the poor.

A marked saving due to the longer service obtained from high-priced goods than cheap ones, is also readily shown in the case of other supplies, such as shovels and scoops, lamp chimneys, lantern frames and globes, galvanized-iron pails and cans, switch-lamps made of steel instead of the frail ones made of thin sheet iron, brooms, brushes and car-washers made of genuine bristles instead of horse-hair, etc. In these cases, as in others, I have satisfied myself that it is an economy to pay the difference in price in view of the longer life and better service obtained. The purchasing agent does not put himself at the mercy of the dealer in confining his purchases to these higher grades of material; for having once decided on his standards, he can always find more than one reputable house ready and able to furnish goods up to these standards, and he thus has the benefit of the competition between these dealers.

The advantage of using a high grade of material is shown in other ways than increased service. Car brasses made according to the proper formula, of a clear, uniform mixture, free from dross and oxidation, with smooth bearing surfaces under the soft lining, and having the proper radius, will show an astonishing reduction in hot boxes, if introduced on a road which has been using brasses bought at a lower price than that at which it would be possible to make a good bearing, or where the brasses were not bought under any specifications and the manufacturer was allowed to furnish anything he pleased. In my own experience, I have seen a startling improvement effected by the introduction of specifications and a rigid inspection of bearings.

Another cause of hot boxes is the use of a cheap, shoddy, so-called "wool-waste," which has no elasticity and settles down in the box and fails to feed the oil up to the journal, and is soon thrown out by the inspector, even if it does not cause the journals to run hot, while an elastic, long-fiber wool will far outlast the other, and keep the bearings well lubricated.

The inspection of illuminating oils is of great advantage to a railroad, preventing the explosion of lamps sometimes caused by the use of oil of too low a flash-point. Where roads do not employ a chemist, these tests can be made by any intelligent man, after a little practice. The danger of using in signal lamps an oil which is liable to fail at a critical moment is too evident to require demonstration, and can be avoided by testing the oil before it is issued for use on the road.

No man can be infallible, however, with the best intentions, and all purchasing agents are liable to errors of judgment, and I am conscious of having made them, and am liable to make them in the future, but I believe the policy I have outlined and defended will tend to benefit the road for which the purchases are made, and



**THE HORNISH MECHANICAL BOILER CLEANER**

The Hornish mechanical boiler cleaner, which is the subject of the accompanying engravings, has been in use for something over 10 years upon several thousand stationary and steamboat boilers, and also upon several hundred locomotive boilers, notably upon the Peoria, Decatur & Evansville, and Evansville & Terre Haute Railways. The inventor has recently developed his appliance to the form shown in the present illustrations. The perfected cleaner is in two parts, which are entirely within the boiler, excepting the air valves and blow-off pipes. Figure 1 shows the application of the device, and figures 2 and 3 give enlarged detail of the parts at the front end of the boiler and in the leg, respectively.

The part that is in the forward end of the boiler reaches from side to side, using the front head of the boiler as a back. The space between the flues and the dry pipe is used as a skimmer. It is so ar-

claimed, does not interfere at all with the proper working of the device.

Referring now to that part of the device which is in the leg of the boiler, and which, by the way, cannot be put in except when the boiler is first built or a new fire box put in, it will be seen that it is practically the same device that empties the skimmer so effectively. It sets on the top of the mud ring, and its suckers, which face the same, are raised 1/2 in. from the mud ring. These suckers all have the same size openings, but vary, from center to ends, in size at the small end of the sucker. This variation is made for the reason that if they were all of the same size the openings nearest the center would pass all sediment, and those farther along the head would not draw their share.

The sediment surrounding this head is always water soaked and is a soft slush which is easily removed by the pressure in the boiler, which pushes them out through the suckers to the blow off pipe before any water or steam can pass through. There

Confederates, and hauled across the country by pike to Staunton, Va., under direction of Col. Thomas R. Sharp. President John W. Garrett, after the war was over, hunted up Col. Sharp and appointed him Master of Transportation, in recognition of the ability displayed in that unparalleled achievement.

**RADIAL AND SLING STAY BOLTS, C. & O. RY.**

There were shown in the October, 1898, issue of the Railway Master Mechanic, engravings of the heavy consolidation locomotive for the Chesapeake & Ohio Railway, designed by Mr. W. S. Morris, superintendent of motive power of that road, and in the description of the locomotive reference was made to the design of sling-stay, and the promise there made to show the stay in more detail is now fulfilled. The illustrations at hand show both the radial stay bolt as well as the sling-stay. The bolt, as also the lower part of the sling-stay, is provided with a substantial hexagonal head under the fire-box crown sheet and a soft-iron washer is placed between the head and sheet to make the joint. The design of the sling-stay will be readily understood and the features appreciated. The bolt and eye arrangement makes it possible to insure that each stay will carry its proportion of the load on the crown sheet, and such assurance is quite impossible with the usual construction of eye-rods with pin connection top and bottom, the rods to be shrunk into position. The present arrangement allows, also, some upward motion of the fire-box but resists any motion downward below the position at which it is set. Mr. Morris' practice on these engines is to use stay bolts 1 inch and 1 1/8 inch diam-

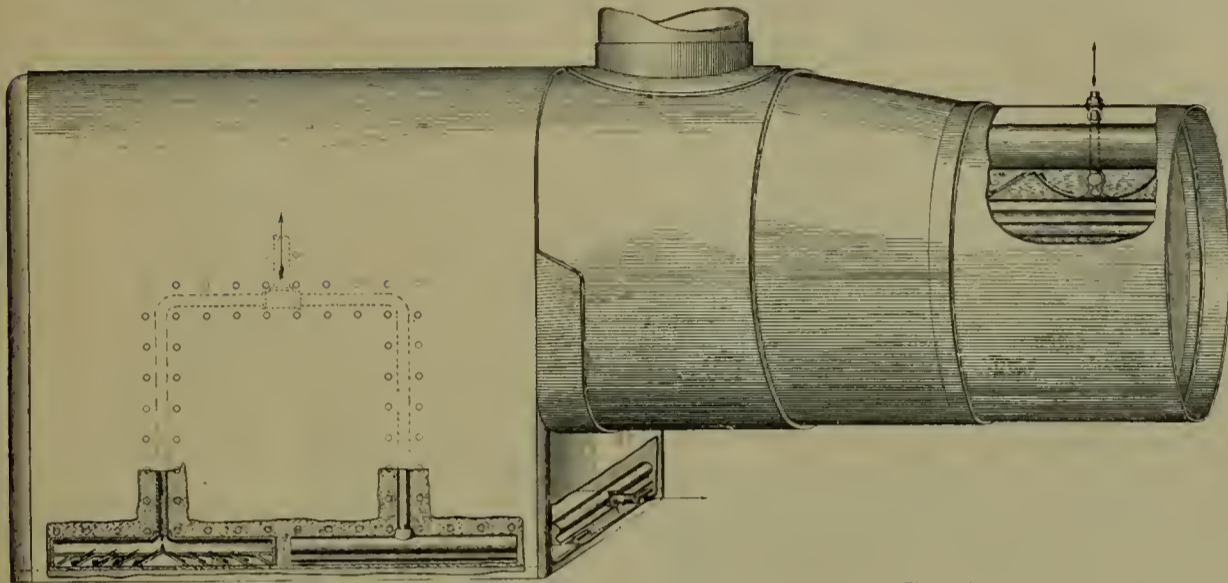

THE HORNISH MECHANICAL BOILER CLEANER—FIG. 1.

anged as to make a perfect surface skimmer, the full width of the boiler, and at the same time it forms a basin of from 20 to 25 gallons capacity, which holds skimmings and settlings, to be blown off at the will of the engineer. The device for blowing off the solid matter that the skimmer catches is so arranged that there is no water wasted at all that is fit to use. When the skimmer is blown off it makes a perfect surface blow-off the full width

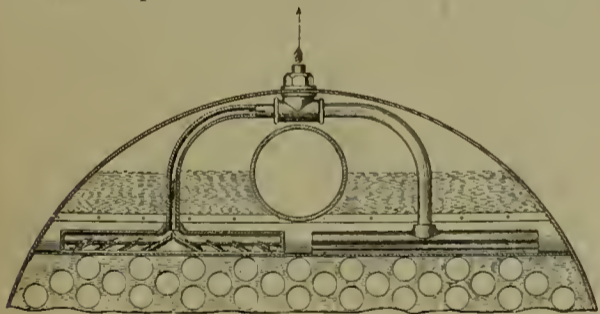

FIG. 2.

of the boiler. Moreover, there is a continuous automatic draw off, with a large storage capacity, to collect and settle all impurities that the skimmer takes from the surface, these impurities being carried to the skimmer by the natural circulation of the boiler. The fluctuation of the water line, it is

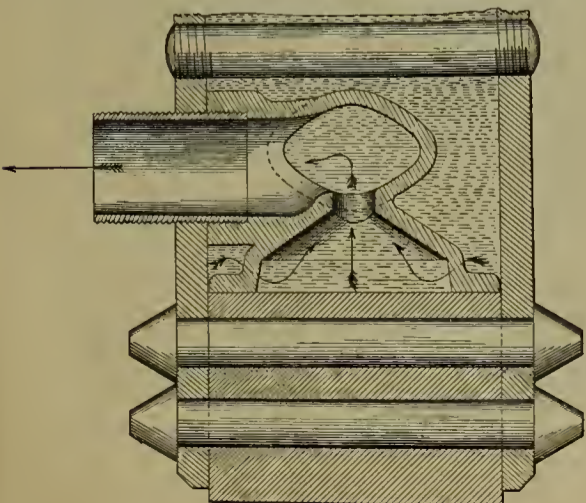

FIG. 3.

is thus no waste of water, as it is shut off as soon as it shows clear

If scale should form from neglect to use the cleaners, or from any other cause, compounds can be used, and what they dissolve and throw down the cleaner will remove at the surface and the leg without resorting to plugs or hand hole plates.

As long as there is a circulation in the boiler, this cleaner is at work, while the engine is idle in the round house, or on the road, skimming the surface and storing up the impurities in the skimmer, to be blown off at will: this reduces the number of blow-offs and waste of water. As both cleaners are blown off before entering the round house, there is little or nothing left in the water, and what there is, is caught while engine is idle, to be blown out again as soon as it leaves the round house. This makes a clean boiler at all times

The advantages to be derived from the use of an effective boiler cleaner are obvious and need not be dwelt upon now. On the Chicago & Northwestern road this device has been given a practical test with very satisfactory results, even though that portion of the cleaner intended for the boiler leg was not used in the test. One report from this road states that an engine equipped with the appliance in the forward end of the boiler made 1304 miles without washing out, whereas 550 miles is stated as the limit with the same engine without the cleaner. One of the mechanical officials of this road, in speaking of the work of this cleaner on one of his engines, says: "It has been of material advantage in preventing foaming, and because of its excellence in this respect, and the fact that it removes considerable sediment from the water in the boiler, we have been able to run twice as many miles between the times of washing out, as formerly. I am pleased to give you this testimony." This device is offered by The Hornish Mechanical Boiler Cleaner Company, 908-909 Masonic Temple, Chicago.

Baltimore and Ohio engine No. 99, which has just been laid aside at Grafton, W. Va., and will be consigned to the scrap pile, has quite a history. It is one of the Ross Winans camel engines and was built in 1851. There are only four of this class of engines now remaining. During the late war this engine was one of several captured at Martinsburg by the

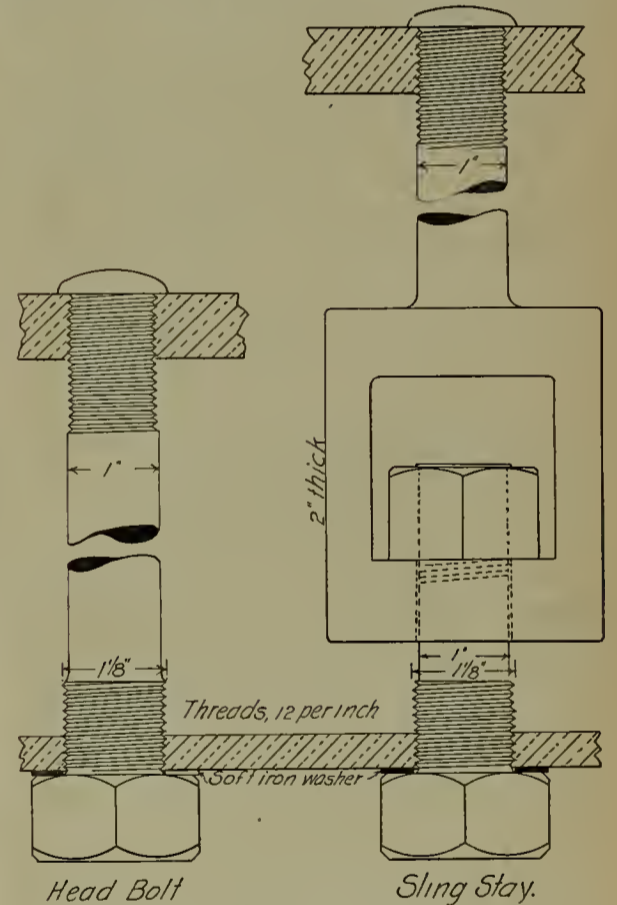

RADIAL AND SLING STAY BOLTS—C. & O. RY.

ter, screwed and riveted to sheets, and not over 4 inch centers. The crown sheet is supported by 1 1/8 inch stay bolts, with four rows having heads on the inside, and two rows of sling stays in front, threads to be 12 per inch.

In order to obtain knowledge at first hand of the conditions obtaining in the rubber producing regions of South America, the Peerless Rubber Company, New York, of which Mr. C. H. Dale is president and manager, recently sent a representative, Mr. Leonard J. Lomasuey, to Brazil. This gentleman has now returned and has made an interesting report of his observations. He believes that the production of crude rubber will be largely increased in the near future, as the higher prices offered for this product of late have caused a large increase of the labor force engaged in the work. That there is room for an almost unlimited increase in this direction is evident, for Mr. Lomasuey says: "As to the extent of the unworked rubber forests, it is almost beyond computation." Even the districts which have long been worked are by no means exhausted and new ones are being frequently dis-

covered. Mr. Lomasney says that the Brazilians have a preference for goods of American manufacture and some permanent trade has already been established. It seems, however, that the efforts of some American concerns to establish their business there have not always been guided by good judgment, and he tells of one New York exporting house which sent a lot of advertising matter down there all printed in English, which their hoped-for customers could not read a word of! From the information obtained Mr. Dale expresses the opinion that the outlook favors a decrease rather than an increase in the present prices of crude rubber.

**TESTING LOCOMOTIVE MATERIALS AT THE LOCOMOTIVE WORKS OF THE MIDLAND RAILWAY.\***

By W. Gadsey Peet, Chief of the Locomotive Testing Department.

The mechanical testing of materials for commercial purposes is now carried on to such a large extent, and is of such great importance, that the following description of the system adopted by the Midland Railway Company at Derby will doubtless be of interest to the members.

All the tests at Derby are made as nearly as possible under the same conditions, so that the results may be comparable one with another; and the material is tested as far as possible in exactly the same condition in which it is received from makers. To this end the test bars are invariably cut from each axle, tyre, etc., from one position and in the same direction. They are machined in the same way, and bars of each particular class receive the same finish. The testing machine is always worked by the same man under the supervision of the test inspector. Thus every bar receives the same treatment and care in handling from start to finish, and no loophole is left to question the results of the tests on the grounds of improper manipulation.

The testing machines in general use are: A 50-ton Whitworth hydraulic testing machine, a Deeley torsion testing machine, a drop testing machine, and a chair and spring testing machine.

Hydraulic Testing Machine.—Figs. 1 to 4 represent the 50-ton Whitworth hydraulic testing machine. It is horizontal and direct-acting, and was originally intended for testing tensile and compression bars 0.5 sq. in. area by 2 in. long; but it has since been considerably modified by Mr. T. G. Iveson so as to meet modern requirements, and bars up to the following sizes can now be tested: For tensile strain up to 24 in. long; for compression up to 30 in. long; for bending up to 5-ft. centers and 16 in. wide. This machine is in general use for making tensile, compression, and bending tests; but it is not by any means a modern one, and does not give absolutely accurate direct readings owing to the frictional resistances met with in the moving parts; these errors, however, are so slight that they may be disregarded for all practical purposes, and may be accurately measured by a method to be described.

It will be seen that the machine consists of two headstocks A and B, Fig. 1, one of which A, contains a hydraulic cylinder 7.98 in. in diameter or 50 sq. in. area, fitted with a ram of 6 in. stroke, having a cup-leather packing, and working under a maximum oil

\* Paper read before the Institution of Mechanical Engineers. Text and engraving reproduced from London Engineering.

Fig. 5. Loaded Ram for Testing Pressure Gauges.

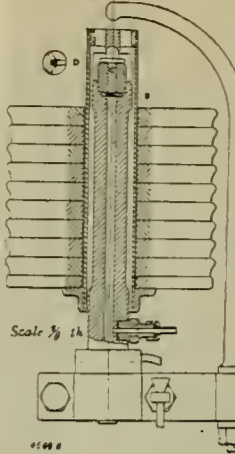
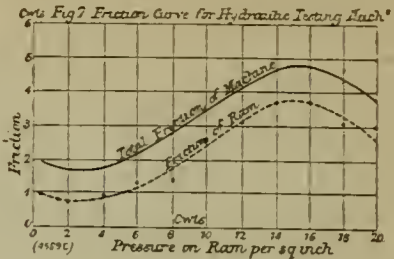
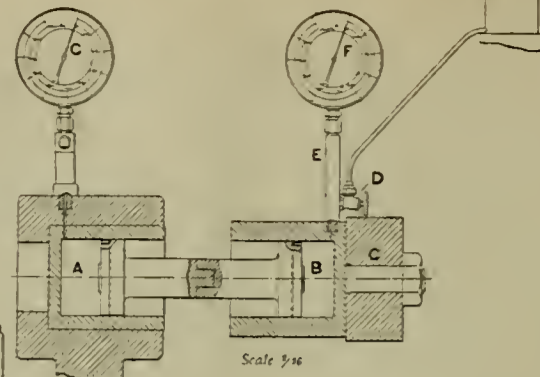

Fig. 6. Arrangement for Testing Friction of Cup Leather.



Carrier and Thrust Piece for Transverse Tests.

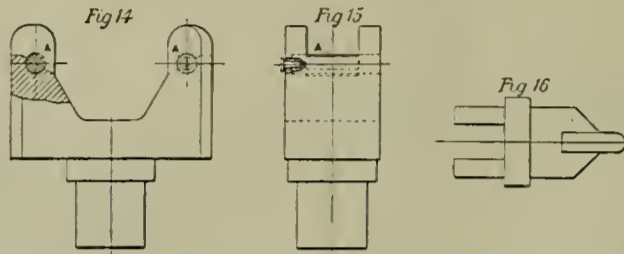
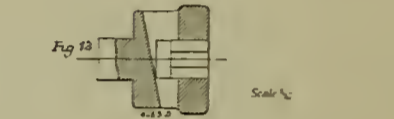
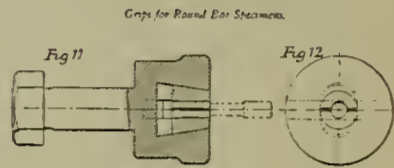
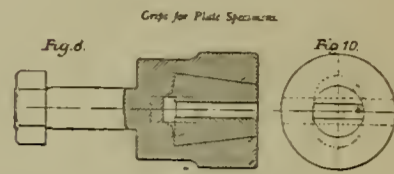

Fig. 17. Tensile Tests on Tubes.



FIGS. 5 TO 17.—TESTING LOCOMOTIVE MATERIALS—MIDLAND RY. OF ENGLAND.

pressure of 1 ton per sq. in. The headstocks are connected by longitudinal tie-bolts C, whereon rest two sliding thrust-blocks D and E, which are actuated by the cylinder ram and move together, being connected by struts F; G, Fig. 1, is the resisting block, and is fixed on the screwed tie-bolts C by nuts back and front; its position can thus be altered to suit varying lengths of test-pieces. Holes are cut in the center of the blocks D, G, E, for attaching the shackles that hold the test-pieces. Tensile test-bars are secured to the blocks G and E; the compression and bending bars are placed between D and G. For enabling the bars to be conveniently fixed, D and E are made to slide longitudinally by a hand lever H, attached to a rack and pinion shown in Fig. 4; and this lever is also used to force the ram back after each test is completed.

The machine is worked by means of a set of belt-driven three-throw pumps, 0.565 in. in diameter and 2 in. stroke, which force the oil through an accumulator, and are thrown out of gear automatically before testing. From the accumulator a steady and gradually increasing load is brought to bear on the specimen, the supply of oil to the testing machine cylinder being regulated by a screw-down valve 0.318 in. in diameter, which has a fine adjustment, so that any desired speed of travel may be given to the ram, and the yielding point may be seen easily. A hand-pump is attached at J, Figs. 1 and 2, and was originally the only means of working the machine; it is now used only when the

three-throw pumps are not available, the pipes being so arranged that either the hand-pump or the belt-driven pumps can be worked without breaking any of the joints.

Two Schäffer and Bndenberg pressure gauges with ordinary Bourdon tubes are placed in communication with the cylinder; one is graduated to 100 tons and gives the stress on a bar 0.5 sq. in. area; the other, which is used for light loads only, is graduated to 10 tons. From these is read to 1-10 ton and 1-100 ton respectively, the yielding point maximum stress, and breaking point of the specimen. These pressure gauges have been graduated by the use of carefully adjusted weights, resting on a frictionless cylindrical oil-tight ram of 1-10 sq. in. area, sliding in a vertical cylinder connected by a pipe to the main cylinder, as shown in Fig. 5, from which it will be seen that there are 10 weights A carried on a sleeve B, having a spherical bearing on the small ram C. The weights are accurately adjusted to 22.4 lb. each, the sleeve and vertical ram going to make up part of the bottom weight. Each load of 22.4 lb. on the 1-10 sq. in. area thus balances 224 lbs. per sq. in., or one-tenth of the maximum load in the testing machine cylinder. It follows, therefore, that, by admitting pressure to the apparatus until the ram head just rises from its seat, the gauge can be marked at various points corresponding with the number of weights placed on the sleeve. Whilst the readings are being taken, the weights are revolved in order to neutralize the vertical sliding friction of the ram C. A piece of wire D is introduced between the ram head and its seat, so as to avoid any surface tension there might be if these faces were in actual contact. The readings obtained are checked by substituting a valve of double the area and repeating the operations. This apparatus is fixed to the testing machine at K, Figs. 1 to 3, and is used for checking the gauges when desired; and various sizes of valves and weights are kept for testing pressure gauges from 10 lb. per sq. in. upwards.

From the description of the testing machine it will be evident that the whole of the pressure in the hydraulic cylinder is not transmitted to the test specimen, part of it being absorbed in overcoming—first, the friction of the thrust-blocks sliding on their supports; and, second, the friction of the cup-leather packing of the ram against the cylinder. In order to determine the amount of the friction of the thrust-blocks, a Salter's spring balance was attached, and the pull necessary to move these blocks was found to be 112 lb. In Fig. 6 is shown the arrangement made for ascertaining the friction of the cup-leather. A represents the testing machine cylinder with its ram and cup-leather packing and pressure gauge G. Attached to a fixed support C is a duplicate cylinder B, having a ram and cup-leather packing exactly similar to those in A. The ends of the two rams are connected, so that they travel together. There are, therefore, two cylinders working under precisely the same conditions, and, presumably, with the same amount of friction in each. The cylinder B is filled with oil drawn through a pipe and small cock D, which is placed on the pillar E of the gauge F. On pressure being admitted to the testing machine cylinder

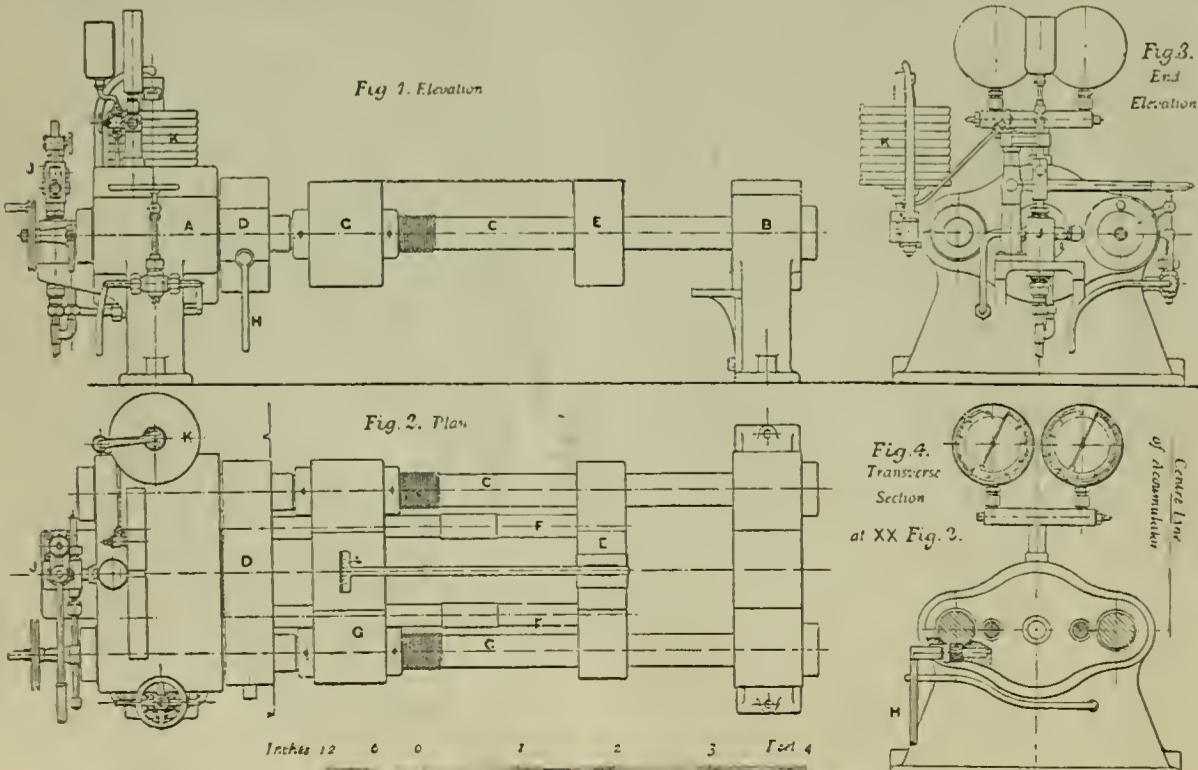

FIGS. 1 TO 4.—TESTING LOCOMOTIVE MATERIALS—MIDLAND RY. OF ENGLAND.



A, the oil in B may be compressed; and any required pressure within the limits of the machine may be obtained by regulating the admission valve to A, and leaving the cock D slightly open to give a continuous travel to the rams. It is clear that, when there is pressure in the two cylinders and the rams are moving, a lower pressure will be registered on the gauge F than on the gauge G, owing to the friction of the leathers; and, the conditions being the same in each cylinder, half the difference between the gauge readings will be the friction of one cup-leather packing.

Previous to this experiment being made, great care was taken to insure the accuracy of the pressure gauges F and G. They were tested immediately before and after the trial, and the readings at the particular pressure at which the experiments were recorded were compared and found to coincide with one another exactly; this being so, the value of the results would not

Fig 18 Tensile Test of Locomotive Fire-box Stays under heat

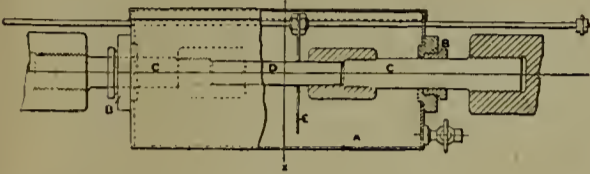
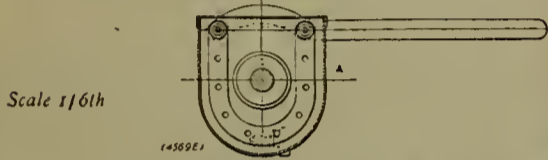

Fig 19 Transverse Section on line X



FIGS. 18 AND 19.—TESTING LOCOMOTIVE MATERIALS—MIDLAND RY. OF ENGLAND.

be affected, even if the gauges did not register absolutely the correct pressure, though there is no reason to doubt that they did. Dewrance pressure gauges graduated to 240 lbs. per sq. in. were used for the readings up to 224 lbs. or 2 cwt. per sq. in.; and all the higher readings were taken from Schäffer and Budenberg gauges graduated to 2240 lb. per sq. in. Both the cup-leathers had been in use for some time, and were quite pliable; and the insides of the two cylinders were in an equally polished condition. There was found to be a discrepancy in the size of the cylinders equal to 0.017 in. in diameter, for which a correction has been made in the results about to be given. The travel of the rams was adjusted to about the same speed as in ordinary testing; but a second series of tests with the cock D shut, and with the rams moving only to an extent due to the compressibility of the oil in B, gave the same results. Simultaneous readings were taken from the two gauges, the pressure on the two rams being carefully balanced; that is to say, the admission of oil into the cylinder A balancing the egress from B, so that the gauge fingers were stationary at the moment of taking the readings. The readings were taken at thirteen different pressures, and were repeated several times with but slightly varying results, the mean of which has been plotted in Fig. 7, after correcting for the above difference in area of the two cylinders. From this diagram it will be seen that the friction is not a constant quantity, but reaches a maximum at a pressure of from 1650 lbs. to 1750 lbs., or from 14½ cwt. to 15½ cwt. per sq. in., after which it falls again. It is interesting to note that this curve confirms more or less the experiments of Professor Thurston, who found that the static friction of lubricated metallic surfaces does not increase uniformly with the pressure.\* The width of the cup-leather bearing on the cylinder is ¼ in.; and assuming the full pressure of the oil to bear over the whole of this surface, the coefficient of friction works out at an extremely low figure.

In order to see how the tests made in this machine compared with a lever machine, the results of 500 tests of steel boiler plates have been selected at random, and compared with tests made from the same plates by the manufacturers at their own works, the test-pieces for the railway company being in each case cut from the portion of the same plate adjacent to that tested by the manufacturers. Four makes of plates were taken; and of the 500 tests compared 85 were found to be below the stress tests of the makers, 383 above, while 32 gave the same stress. Taking the mean of these, the Midland Railway tests came out at 0.54 tons per sq. in. above the manufacturers' tests; and after deducting for the friction of the machine, amounting to, say, 0.11 tons, the results are as close as might reasonably be expected.

A simple apparatus is attached, for enabling diagrams to be taken by hand. It consists of a scale L, Fig. 2, resting on the resisting-block G, and connected by an arm to the sliding thrust-block E, the movement of which, as the specimen yields, causes the scale to travel over the paper. The pressures are read off the gauge, and recorded by hand as dots, through which a curve is afterwards drawn.

\* "Friction and Lost Work in Machinery and Mill-work," by R. H. Thurston, page 316.

Method of Holding Test Specimens.—The shackles, etc., for holding the various specimens are shown in Figs. 8 to 12. Figs. 8, 9 and 10 represent the grips used for plates, in which the dies are circular on the back, instead of flat, as is usually made, which enables them to adjust themselves to plates of uneven thickness. Two sets of dies are used, capable of taking plates up to 1 in. in thickness; their taper is 3½ in. per foot. Figs. 11, 12 and 13 represent the grips used for round tensile bars; they are similar in design to those used for plates. Figs. 14, 15 and 16 represent the carrier and thrust-piece used in making transverse tests. Two rollers of hardened steel are introduced at A to support the ends of the bar. This is found to be preferable to the previous arrangement, in which fixed supports were used, because these in time wore away on the inner side, causing the distance between them to be increased, and so giving inaccurate results. The thrust-piece at B, Fig. 16, is faced to a radius of ⅝ in. The bars are first bent to right angles in the carrier, and then taken out, the operation of bending being completed by applying pressure to the ends of the bent bar. Fig. 17 shows the method of making tensile tests of tubes. The test-pieces are short lengths of tube tested whole, that is to say, without flattening out the tube. The ends are first expanded by means of cones A, nuts B with a corresponding taper being previously placed on the outside of the tube; these nuts are then

the cast bars of No. 4 bronze which were not appreciably affected by testing at the higher temperature, it was thought that this degree of heat had an annealing effect on the rolled bars, and thus reduced their tensile stress; but when bars of the same material were annealed in oil at 370 deg. Fahr. and afterwards tested cold, practically the same results were obtained as from the unannealed bars. The copper in these tests was of ordinary commercial quality, containing about 99.2 per cent of pure copper. The bronzes were of various mixtures, which have been analyzed by Mr. Leonard Archbutt, F. I. C., with the results given in the preceding column.

(To be continued.)

A PNEUMATIC BAGGAGE HANDLER.

A very clever use of air, as a labor saver, has been made on the Grand Rapids & Indiana. Mr. G. H. Wall, of Cadillac, who is connected with that road, last spring built and applied the pneumatic baggage handler shown in our engraving. This device proved itself, in daily work, able to handle heavy baggage more rapidly than it could be otherwise handled, and to, moreover, do away with breakage of baggage. It consists of a very simple arrangement of

air cylinder and baggage support. The cylinder rests on the threshold of the car door. The upper portion of the baggage support is semi-tubular in form and is swiveled to the cylinder; and one side of this tubular portion is cam shaped and bears against a plate placed just above the door. Thus when the support is rising it is automatically swung around by the cam action, carrying the baggage into the car. The device is operated by air drawn from the train line to a special reservoir and is handled by

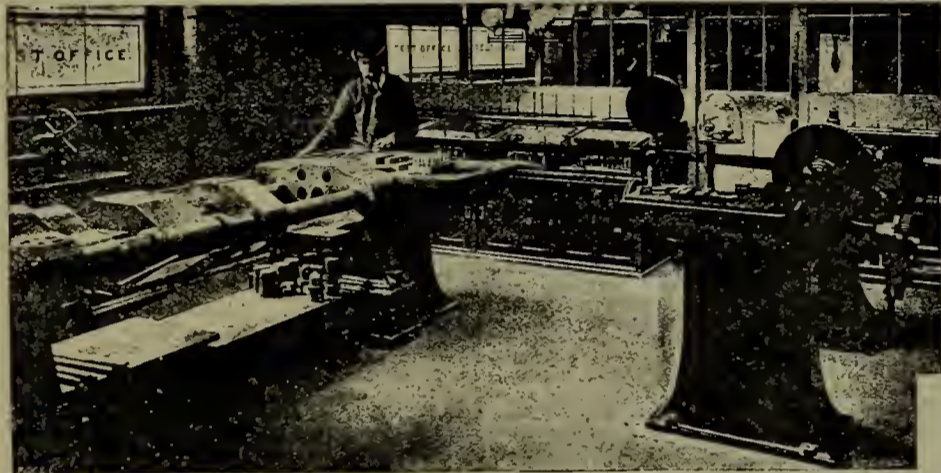

TESTING ROOM—MIDLAND RY. OF ENGLAND

screwed into sockets C secured to the testing machine, and the ends of the tube are thereby gripped, the cones A being left in to prevent them from collapsing when the nuts are screwed up. Figs. 18 and 19 represent the apparatus used for testing locomotive firebox stays, etc., under heat. This consists of a light copper casing A, having a stuffing-box B at either end, through which pass steel bolts C, secured to the testing machine at their outer ends, and connected by a screwed coupling by a firebox stay D inside. The casing is filled with mineral oil, having a high flashing point, heated by means of a Bunsen burner, and kept in circulation by a perforated stirrer E.

Tensile Strength and Elongation of Copper and Bronze Firebox Stays. Cold and Hot.

Material.	Number of Tests.	Tested at 60 Deg. Fahr.		Tested at 370 Deg. Fahr.		Loss of Tensile Strength.
		Tensile strength per Square Inch.	Elongation.	Tensile strength per Square Inch.	Elongation.	
Copper.....	6	Tons. 14.9	Per ct. 52.0	Tons. 17.2	Per ct. 50.7	P. c. 18.1
Bronze No. 1.....	2	35.8	31.0	28.0	27.5	21.8
" No. 2.....	6	23.7	58.2	20.4	64.3	13.9
" No. 3.....	4	22.8	44.0	20.7	42.0	9.2
" No. 4.....	8	13.1	6.6	13.0	8.5	0.8

Analysis of Bronzes.

Bronze .....	No. 1.	No. 2.	No. 4.	No. 4.
	Per cent.	Per cent.	Per cent.	Per cent.
Copper.....	58.86	61.89	97.18	83.81
Zinc.....	35.15	36.18		0.14
Tin.....	0.72		2.85	12.22
Manganese.....	3.64	0.85		0.06
Lead.....	0.51	trace		1.56
Iron.....	1.27	0.63		
Nickel.....		0.60		
Antimony.....			trace	0.23
Phosphorus.....		trace	0.01	
Bismuth.....		trace		
Total.....	100.15	100.15	100.04	100.02

A series of tests have been made with this apparatus to determine the loss of tensile strength in copper and bronze stays, etc., at a temperature of 370 deg. Fahr., which is the temperature of steam at 165 lbs. boiler pressure. The mean results are given in the accompanying table, the elongation being measured on a length of 2 in.

With the exception of bronze No. 4, which is used for such purposes as slide valves and axle boxes, and was cast from an ingot into bars 1¼ in. in diameter, the tests were taken from rolled rods intended for firebox stays. In each case the specimens were turned down to the size of the ordinary test-bar. As it was only



PNEUMATIC BAGGAGE HANDLER.

scale device, located at about the center of the vertical length of the baggage support, provides for weighing the baggage as it is handled.

## CAR FOREMEN'S ASSOCIATION OF CHICAGO.

## November Meeting.

The regular monthly meeting of the Car Foremen's Association of Chicago was held in the Great Northern Hotel, Thursday, Nov. 10. President T. R. Morris in the chair. Among those present were the following:

Burnett, R. W.	Johannes, Albert.
Bates, B.	Krump, M.
Blohm, Theo.	Morris, T. R.
Cook, W. C.	Nordquist, Chas.
Coleman, J.	Olsen, Louis.
Constant, E. J.	Sharp, W. E.
Davies, Jr., W. O.	Smith, E. B.
Deen, C.	Smith, R. G.
Depue, Jas.	Schoeneberg, C.
Grieb, J. C.	Schultz, Aug.
Groobley, Geo.	Showers, G. W.
Gordon, Lewis.	Stuckie, E. J.
Gehrke, Wm.	Thrall, John.
Hennessey, J. J.	Van Vliet, J.
Hansen, Andrew.	Weaverson, F.
Holtz, Christ.	Wentzel, Geo.
Holtz, Chas.	Williams, Thos.

Pres. Morris—The minutes of the October meeting have been published in the Railway Master Mechanic, and no doubt have been read by all present. If there are no objections they will stand approved as published.

## New Members.

Secy. Cook—The following have made application for membership in this association, and having been approved by the executive committee, will be enrolled as members.

Jos. Lutz, M. C.; H. LaRue, C. & A.; Chas. Wolfe, Wm. Senger, Geo. Thomson, and Jas. P. Baikie, L. S. & M. S.; E. J. Constant, C. Jet. Ry.; C. L. Saum, J. G. McLaren, and Chas. Nordquist, C. & E.; P. H. Peck and Wm. Hagge, Belt Ry.; J. Boker, C. C. C. Co.; F. W. Brazier, I. C. C. S. Stagg and K. Davies, C. & G. T.; Jno. Van Vliet, Chas. E. Green, Henry Herwig and M. M. Miller, C. L. S. & E.; Thos. Donlin and A. A. Jones, C. G. W.; Wm. Kramer, P. F. W. & C.; L. Etten, L. R. L.; B. Bates, C. & N. W.; Aug. Schultz, P. C. C. & St. L.; Henry Goehrs, Chas. Cork, E. R. Campbell, W. A. Parker, Gust. Larson, M. D. Furey, M. Parkinson, C. McCullom and A. P. Hansen, C. M. & St. P.; T. B. Kirby, Armour Car Lines.

## Miscellaneous Business.

The committee on entertainment here made report, giving an itemized list of expenditures in connection with the excursion of Oct. 17. It showed a cash balance after all accounts were paid, of \$38.92. The report was approved and the committee discharged.

Pres. Morris—If there are no objections this cash balance in the hands of the committee will be turned into the treasury, to be used to meet the general expenses of the association.

The committee appointed to draw up resolutions of thanks to Mr. Eden, proprietor of the Great Northern Hotel, for favors shown, here presented suitable resolutions which were accepted and approved, and the secretary was directed to forward copy of same to Mr. Eden.

Pres. Morris—I want to say that I have appointed as committee on introductions, Messrs. Davies, Jr., Callahan and Sharp. In explanation of the appointment of an advisory committee, I will state that through a misunderstanding of the by-laws as revised, the executive committee had to be reduced to conform to the number allowed by the by-laws and it was thought advisable to appoint as advisory committee the following members: P. H. Peck, chairman; F. W. Brazier, J. C. Grieb, H. V. Kuhlman, L. T. Canfield and R. Wharton. In addition to the officers the executive committee will consist of T. B. Hunt, S. Shannon and William Gehrke.

Secy. Cook—I have received a letter from Mr. J. C. Grieb of the C. M. & St. P. Ry., transmitting a bound copy of a complete file of the decisions of the arbitration committee from decision No. 1 to the last decision.

Pres. Morris—This is a very complete and valuable reference work and I think there is no question but that it will be used and appreciated by the members.

On motion of Mr. Davies the association extended to Mr. Grieb a vote of thanks.

## Discussion of Disputed Case.

Pres. Morris—There is a case in dispute between two members representing Chicago lines, which came before the meeting in September, but which was not settled at that time. It has been written up and placed in the hands of all members, and is as follows:

"A" receives a car from "B" ("B" being a switching road) with door stop broken. "A" asks "B" for defect card. "B" claims that they received car from "C" in same condition. "A" then takes the matter up direct with "C." "C" claims that a broken door stop is owner's defect. "A" claims that from the nature of the defect and marks on the car, it is very apparent that car had been raked. "C," while not denying the defect and having no record of its claims that the record of both "A" and "B" is "Door stop broken" only and that no

mention is made, in their records, of the car having been raked or having met with unfair usage, "C" refuses to issue card.

Mr. Sharp—In order to get the members started to talking on this, I would like to ask why it was necessary for "A" in this case to show how the door stop was broken. The mere fact that the door stop was broken—and A has so stated in correspondence which passed back and forth with the request for defect card—it seems to me should be sufficient. The ground on which C declines to issue card is that there is no mention made in either the records of A or B as to how the door stop was broken. I infer from that that C takes the ground that the record has got to say "broken by unfair usage." I do not think this is necessary.

Mr. Davies, Jr.—If A made a request for broken door stop I believe that he should have said whether the stop was broken on account of unfair usage or not. If it had not been raked of course it would be an owner's defect, and in making request for door stop broken it should have been stated that the stop was broken on account of being raked.

Mr. Showers—I don't quite understand this case. Reading it we see A received the car with door stop broken. A asked B for defect card. B says he received it in same condition from C. A then takes the matter up with C. In the first place why should A take the matter up with C. A is not supposed to know C in the case. The matter should be taken up with the road that delivers the car to them. There is a question whether there was any unfair usage or not. I would like to hear a reply to that part of it.

Mr. Sharp—As I understand the case Mr. Showers is right in the fact that the matter should be taken up direct with B, but it is a practice to some extent at least around Chicago that an intermediate road furnish its records and the railroad companies correspond direct. I do not know how general that is, but I know that was our practice when I was with the Erie R. R. The request for card which was handled by clerk in the office merely said "broken door stop." Now, that is evidence that door stop was broken by unfair usage, otherwise card would not have been requested. C was asked for defect card and answered that it was an owner's defect. Then A in turn answered him and stated how the door stop was broken. It is not a question of veracity, it is a question that C has raised and stated in his correspondence that in order to get defect card records should show that the door stop was broken by being raked or unfair usage. The car was inspected by A's inspector and also by B's inspector jointly and both agreed that damage occurred account unfair usage.

Mr. Grieb—I would like to inquire if such joint inspection as represented in this particular case is general. It seems to me that the only question at issue is to ascertain whether the damage to the door stop was due to unfair usage or otherwise. There is no principle involved. It is just an attempt to get at the facts in the case. It is generally conceded that a door stop broken by fair usage is chargeable to the owner.

Mr. Davies, Jr.—According to this statement C refuses to issue defect card merely because A's and B's records do not show that stop was broken on account of being raked. That is all he has for refusal of card on. The receiving line is the judge and I think that C should issue card.

Mr. Grieb—I would like to raise another inquiry, which is, is it not customary in interchange of cars in Chicago to accept statement of receiving line as final and as a basis on which demand for card is made.

Pres. Morris—It is pretty generally conceded that the mere fact that A asked for a defect card is evidence that the defect was cardable or in other words was caused by unfair usage.

Mr. Deen—The receiving road is supposed to be the judge. If they consider the damage done by unfair usage they ask for a defect card. If broken by fair usage they undoubtedly would not ask for a card.

Mr. Thrall—I would like to say that I made a joint inspection of the car in question and found marks on the side showing car had been raked.

Mr. Grieb—I would like to say that in view of the fact that in interchange of cars at Chicago it is customary to accept the record of the receiving line the latter is the judge, and when its treatment is of such a positive character, it should carry with it more force than that of the delivering line, which is more of a negative character.

Mr. Davies, Jr.—I move that it is the sense of this meeting that as the receiving line is the judge of the condition of the car C should issue defect card.

Carried.

Discussion of the paper on "Air Brake Practice," presented by Mr. Kidder was postponed until December meeting.

## Arbitration Case No. 502.

Pres. Morris—Mr. Wentzel of the Belt Ry. has requested that arbitration case No. 502 be brought up for discussion. We would like to hear from Mr. Wentzel on the subject upon which he wants light.

Mr. Wentzel—We are getting a great many cars from our connections with air hose torn off and of course the

coupling gone. When we give the cars to connecting lines on the other side they demand defect card and if we turn around and ask the party from whom we received the car to protect us they say "charge to owners." Now, when the arbitration committee decided this case it was simply meant for parties doing damage and making repairs themselves. A car in interchange with air hose torn off is about the same as one with a brake shoe lost. If a railroad delivers a car with brake shoe lost it is responsible and I think it should be the same with a torn off hose.

Pres. Morris—In order that members may speak intelligently upon the arbitration case mentioned I will read it. (Reads case.) Now, as I understand it, Mr. Wentzel wants to get the sense of the meeting on the liability of the road that delivers a car to another with a torn off hose.

Mr. Wentzel—These repairs are chargeable to owners if the party who does the damage makes the repairs, but if they offer it in interchange, they, and not the owner, are responsible.

Mr. Grieb—It seems to me that Mr. Wentzel's position is correct. Section 20 of rule 3 covers the case.

Mr. Showers—I move that it is the sense of this meeting that when a car is offered in interchange with hose torn off the delivering line is responsible.

Carried.

The first topical subject relating to change of brasses was, after a short discussion, laid on the table to be taken up at some future time if the association decided to do so.

## Treatment of Hot Boxes.

Pres. Morris—The next question for discussion relates to hot boxes and is the second topical subject.

Mr. E. B. Smith—I have had but little experience with cooling compounds. They are all right if used properly. If a cooling compound is put in its proper place it might be of some service, but otherwise not of much use.

Mr. Showers—I was once running an accommodation train and had lots of trouble with hot boxes on our engine tank. We once stopped at a station and a man came up and told me to pack the boxes with soft soap. I did so but did not use a particle of oil and it never ran hot for 30 days.

Mr. Gehrke—My experience with hot boxes is very limited and I don't think I could give you any information. I agree with Mr. Showers that soft soap is a very good thing.

Mr. Hennessey—That is a question that has been discussed for quite a number of years. There may be cooling compounds of some value, but the great majority are not equal to the common black oil used to-day on cars. I think the best thing to do is for cabooses to carry a pail of waste well soaked in oil. First remove the old waste and then repack with freshly saturated packing. Tallow is the only cooling compound in my opinion that is effective.

Mr. Deen—I agree with Mr. Hennessey that the best thing to use is the oil that is in use every day. A good thing for a hot box on the road is a handful of air slacked lime.

Mr. Showers—I look at the matter in this light. Black oil is all right in packing boxes, but it should not be used when boxes are exceedingly hot. What we want to find out is it practical to furnish trainmen with a dope to use on the line.

Pres. Morris—That, I believe, is what the question is intended to bring out.

Mr. Showers—If the cooling compound will make an attempt at cooling the journal so that you can get out of the way of other trains it is all right.

Mr. Wentzel—I have found that soap is as good as anything to cool off journals. Cut a bar of soap in two, put it in the box and I will guarantee that your box will cool off.

Mr. R. G. Smith—I mixed up a compound of my own made of tallow, brimstone, lye of hard wood ashes and a little borax. I have tried it on hot boxes and found it cooled them off all right. The train men said it worked all right.

Mr. Davies, Jr.—My idea is if a cooling compound will bring a car to its destination it is a good thing to use. Railroads don't care if the journal is cut or not if they get the car to destination. Trainmen have no time to repair a box. They never touch a box till it is very hot, when it is at a white heat and oil is no good then. That is the time to use cooling compound.

After some further discussion it was decided to hold the subject over to the December meeting. Some of the members promised to have trainmen on hand at that time to give their views. It was also suggested that representatives of the manufacturers of cooling compounds be requested to be present to explain the use of it.

This closed the discussion and the association adjourned to meet December 8. The

## Program for Next Meeting

is as follows:

(1) Postponed discussion on Mr. Kidder's paper on air brake practice.

(2) A continuation of discussion on the subject of treatment of hot boxes on the road.

(3) A question of interchange in dispute between two members will be discussed.

(4) An address from Mr. J. N. Barr, supt. of motive power of the Chicago, Milwaukee & St. Paul, is expected, provided his duties will permit.

#### COMMENT BY CAR FOREMEN.

This column is edited by the Publication Committee of the Car Foremen's Association, and the RAILWAY MASTER MECHANIC is not responsible for any of the views expressed therein. Communications and items of interest to car men are solicited. T. R. Morris, chairman.

#### Merging of Car and Locomotive Departments.

The policy of merging the car and locomotive departments and giving the same in charge of one official is probably not considered a good one by a single car man. The locomotive man, with a few notable examples, knows very little about cars and probably has no time to learn. Most of them being placed in the position mentioned, delegate to a practical car builder the work of running the car department.

The latter's advice is sought upon all occasions, he does all the work and shoulders the responsibility, while the other receives the glory. The wood shop and the paint shop are mysteries to the average engine man. His experience in painting locomotive tanks hardly qualifies him as a judge when it comes to the painting and varnishing the outside of a sleeper or finishing the woodwork on the inside.

In this age of specialties it would seem that the responsible and supreme head of the car department should be one educated to that branch of railroad work.

#### Treatment of Hot Boxes.

What is the best treatment for train-men to give hot boxes on the road? This question would probably be answered by train-men in as many different ways as there are men of this class and the more or less ingenious ways of handling this problem would vary according to the ability or experience, or a combination of both these requisites, possessed by the man.

Most of the freight trains are "fast" and it is desirable to make as nearly schedule time as possible. A delay means missing connections, failure to deliver freight to consignee promptly and sometimes loss of business. It also means a black mark for the conductor, and a succession of them a "lay off."

The proper way to handle a hot journal, is perhaps to allow it to cool, and if not cut, apply a lead lined bearing, finally repacking it carefully with good clean waste well soaked in a lubricating oil, but the item of "time" comes in and prevents this in most cases. On many lines a cooling compound is used, but a number of serious objections are found to this.

The ingredient which is most effective as a cooler is not a lubricant and it forms a crust between the packing and the journal through which the oil will not feed and the result is a cut journal and a most dangerous one at that—dangerous inasmuch as it does not blaze nor smoke to signal to the train-men that it is again hot, and the result is perhaps a burnt off journal.

Train-men have ways and means of their own of cooling hot boxes; some will swear by soft soap, others hard soap, others again lime, and so on.

While there seems to be but little doubt that good oil is the best lubricant, it is impossible to use it on a hot journal, for the reason that the heat will cause it to run from instead of being carried up to the point where it is required.

A compound of a consistency capable of being so placed in the box that it will retain the position until the heating has been reduced is most desirable.

The question of mechanical defects has not been considered, for the reason that when they exist to any great extent, ordinary means of cooling off a hot journal will be unavailing.

#### Defects in Construction.

The highly artistic wood work and ornate finish of first-class passenger cars, both sleeping and day coaches, that have recently been built and put into service on the limited trains of our most prominent roads, show that the general managers and master car builders are alive to the importance of keeping up with the times. Nothing, apparently, is left undone that will in any way contribute to the pleasure and comfort of the traveling public. Elaborate details are worked out, and miracles almost, performed in utilizing every inch of space. When the cars are finished they are inspected, criticized, written up and pronounced perfect.

For weeks previous to the time set for these gorgeous palaces on wheels to go into service, those who travel have their attention called, in various ingenious ways known to the advertising agent, to the luxuries which the railway company intend placing at the disposal of those who will patronize that particular line.

The auspicious "opening day" arrives and all, from the president of the road down to the grimmest car repairer or the least significant calico jacketed car cleaner metaphorically hold their breaths until the train has left the station and has safely started on its way. The subsequent day there is a trifle less interest taken in the departure of the train, and in a week's time its going and coming is a matter of routine.

We are then confronted by another phase of the ques-

tion, one whose importance is not always appreciated. This is proper maintenance. It is to be regretted that in drawing plans and specifications due consideration is not given this matter.

In the sleeping car of today the item of plumbing is a serious one and it is very necessary that the pipes should be so arranged that there is the minimum danger from frost. Also access to them should be made easy, as it is the particular part that is farthest away and most difficult to reach, that is found usually to be the seat of the trouble.

The toilet apparatus should be as simple and as free from complicated parts as good service will allow. Hundreds of instances could be given of its requiring three or four hours to take down and put up parts, while the actual work of repairing the defects was accomplished in fifteen minutes.

Take the matter of heater pipes. Unless they are closely watched, the steamfitters, when doing their work, will consider their own convenience rather than that of the man who comes after them. In fact it sometimes appears that special effort had been made to cause the item of repairs to be as costly as possible. It is a great mistake to be economical in the use of right and left couplings and ells in steam or heater pipes. It is a little more trouble to put them in originally, perhaps, but in the matter of repairs their absence is felt when it comes to taking up half the seats in a car, not to speak of removing woodwork, or taking out nearly the whole piping on one side.

The setting of the Baker heater is another illustration of this. It is a difficult matter to convince the ordinary repair man that the heater was not placed in position and the partition built around it. In the modern sleeper a distance of two inches between the heater and the side of the heater room is considered an extravagant waste of valuable space. The consequence of this economy is that when a steamfitter discovers a leak in a joint back of the heater, he finds the only way he can reach the defective part is by taking the heater apart. After this job of 4 or 5 hours is concluded he oftentimes finds the source of the leak is a loose joint and remedies the difficulty by giving the pipe a couple of turns with the tongs, which is done in a few minutes.

The water tanks which are placed close to the roof are apparently put up with the idea that while the vibration and pounding of the car may rack the framing and loosen the points of the woodwork, the tanks themselves and the pipe connections thereto are made of "sterner stuff" and will never require attention. But the illusion is dispelled so far as the repair man is concerned when he discovers a leak. Five minutes with the soldering iron repairs it, but from 20 to 25 hours is consumed in taking the tank down and putting it up again.

Nor must the car cleaner be forgotten in this tale of woe. He has troubles of his own, caused by lack of foresight, or ignorance on the part of the builders of the conditions that obtain when cars are put into active service. Steam or heater pipes placed too close to the floor, or seat stands improperly arranged, collect dirt that is difficult to dislodge.

Carvings and deep recesses in woodwork gather dust that quickly assumes a whitish appearance and causes reports from the inspector.

An unnecessary amount of time is spent in cleaning the glass of double windows with the space of a fraction of an inch between the inner and outer sashes to work in. This could be obviated by an arrangement of hinges on the outer sash.

The list could be drawn out to an almost indefinite length, but the above will perhaps be sufficient to "point a moral."

In the matter of freight car construction it is pleasing to note that the tendency in the past few years has been to embody features whereby repairs to the parts can be easily and quickly made. It is to be hoped that this will continue and the use of any contrivance not so designed be discouraged. T. R. M.

#### Communications.

##### Electric Lighting of Trains.

To the Editor:

One of the principal requisites of a strictly modern and first-class train is that it be well and properly lighted.

Among the foremost of present means to attain this end is electricity, which, though in somewhat of an experimental stage in this capacity, is rapidly forcing its way to the front and bids fair to become the light of the future.

Its safety, cleanliness and adaptability to position render it a boon to the traveler and a source of satisfaction to the railroad company, while its brilliancy is apparent to the most casual observer.

The existence of electric lights properly installed is a guarantee to the occupants that the danger of conflagration from lamps in case of accident or wreck is practically eliminated.

In the matter of cleanliness, its superiority over dripping oil lamps and smoky gas jets must certainly be appreciated by all passengers, especially the feminine portion thereof.

Another feature is the ease and cheapness with which it may be placed in positions most desirable, thereby

making it a source of pleasure and comfort to the business man as well as the tourist.

The pioneer method of applying electric lights to trains was from a small generating plant in the baggage car. While this system is still in use in a much improved form, the storage battery is asserting its advantages.

Experiments are being made daily with results which indicate that future developments will see it universally adopted.

There are many problems yet to be worked out, the principal one of which is economy both as to construction of cells and maintenance and operation of the same.

In order that the best results may be obtained it is necessary that those upon whom the responsibility for the success of the light directly depends, should possess proper intelligence.

They should have a certain amount of technical knowledge of the subject that they may meet emergencies and improve upon conditions.

It is then safe to assert that the storage battery with its anticipated improvements and with proper handling by experienced men will undoubtedly become permanently established.

W. J. B.

##### Worn-Out Brake Shoes in Interchange.

To the Editor:

The understanding recently arrived at by the different roads in Chicago relative to Rule 3, section 20, where it refers to worn out brake shoes, seems to be working very well.

None of the complications that some thought would come up have materialized and it has been the means of saving lots of writing and requests for cards.

I think the association did a good thing when it took this matter up and settled it in this way.

There are many other questions that could be taken care of and disposed of and they probably will in time.

J. E. S.

#### THE AIR-BRAKE SITUATION.

The Westinghouse Air-Brake Company authorizes the following statement in regard to the New York and Boyden companies:

The purchase by the Westinghouse Air-Brake Company of the patents and business of the Boyden Brake Company is the final conclusion of a long and interesting litigation relating to air brakes.

The course of these suits has been followed with interest by railroad men, because to a considerable extent they involved the right of the Westinghouse people to the sole manufacture of what is known as the "Quick Action" brake. By the purchase of the Boyden inventions, which the Supreme Court said were highly meritorious, the Westinghouse Company still claim to control the situation, although this is contested in the United States courts by the New York Air-Brake Company. The Westinghouse company have been successful in compelling the New York Company to cease making three different forms of brakes, and they claim that a fourth one which they are now putting on the market is also an infringement of their patents. This question will be finally determined by the Court of Appeals, probably in November or December, the opinion of the lower court having been favorable to the New York Company. Should the decision be favorable to Westinghouse, then the New York Company will once more be enjoined, and prevented from making their present style of brake.

In addition to this particular suit, it appears that the Westinghouse people have brought three other suits against the New York Company, and it would therefore look as if litigation between these two concerns was to be, if anything, more protracted than that between the Boyden and Westinghouse companies.

#### A NEW UNIVERSAL GRINDER.

The Universal grinder shown herewith is the latest pattern machine manufactured by the Diamond Machine Co., of Providence, R. I. They have been making Universal grinders for 10 or 15 years, but their first machines were crude in comparison to this, the highest and best evidence of their mechanical skill. The increasing nicety with which machine shop work must be done had demanded within the last few years a machine which would embody all the finest possible adjustments and facilities for doing a large variety of work. The machine that most nearly fills the use of the average machine shop is the universal grinder, as on this machine any cylindrical or concave surface may be ground, and, by means of attachments, cutters, reamers, etc., may be sharpened; internal grinding of all sorts can also be done, and surface grinding to within the limit of the

machine, which is usually small for this class of work.

The machine here shown has wheel spindle, head stock and foot stock of steel, carefully ground and run in bronze boxes adjustable for wear and protected from emery dust.

The wheel-stand slide swivels, and has a graduated base. The end of spindle is drilled to take taper mandrel for carrying small wheels for facing work. The head is removed when the internal grinding fixture is used. The wheel stand is moved by hand wheel graduated to thousandths of an inch on diameter of the work. It has an adjustable stop, so that the wheel may be run back and brought up to the same place as before. When internal grinding is done the wheel stand is removed and the internal grinding fixture shown is substituted.

The sliding table carries a swivel table turning upon a center pin. The swivel table is provided with tangent screws in order to set it accurately, and has graduated scales.

The sliding table may be fed in either direction by hand or automatically, the amount of travel being controlled by dogs which engage a lever on the front of the machine. The slides are carefully scraped to straight surfaces and are protected from emery dust.

The head stock is clamped to the swivel table. It swivels and has a graduated base and may be set at right angles for grinding work on face plate or chuck, or at any degree for grinding centers. The front end is threaded and fitted with a No. 1 Morse

New York, Philadelphia, Baltimore and Washington. This train consists of the usual complement of up-to-date cars. The cars were built especially for this service by the Pullman works. They are beautiful specimens of the car builder's art and when ex-

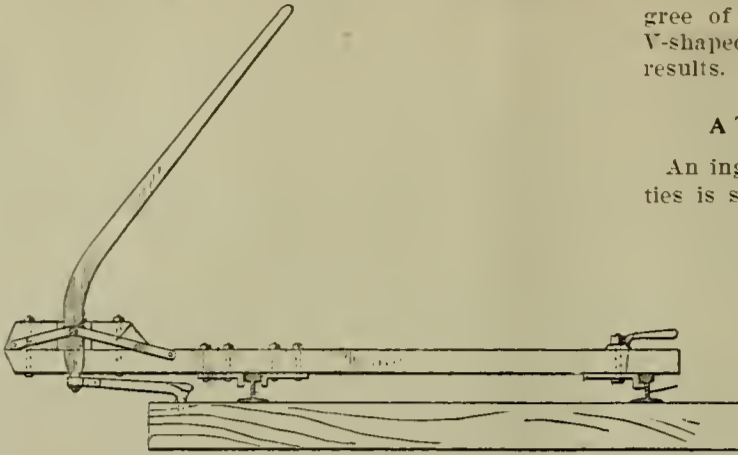

THE SMITH TIE EXTRACTOR AND REPLACER.

hibited at various points commended the warmest praise for their beauty of design and finish.

### THE SHEARING AND PUNCHING OF METALS.

The shearing and punching of metals was treated recently in a paper before the Institution of Civil

Engineers of England. The author had made experiments, with the aid of an especially devised dynamometer and an elasticimeter, to determine the point absorbed by and resistance overcome by shearing and punching machines. He found that space has no influence on the amount of power required for shearing, his diagrams being practically constant whether the machine is run quick or slow. He also finds, by examining the striations in the interior of iron submitted to the operation of shearing, that the curves produced therein are concentric instead of parallel, and that the effect is one of traction, the fibers being gradually attenuated in curving until the point of rupture is reached. A similar result was observed in the case of punching (on a counter-sunk bedplate), the displacement produced being effected by the drawing

out of the fibers until their final rupture is completed by the edge of the punching tool. He considers that the resistance offered by the metal to the entrance of the nipple of the punch can be utilized as an indication of the degree of hardness of the former.

Another subject dealt with is the advantage of making the matrix of the punching machine of a somewhat larger area than that occupied by the face of the punch, since otherwise an effort of compression is exerted laterally on the lower strata of fibers in the metal subjected to the operation, and results in the bending of the rod or sheet and in the production of internal fissures. This compression also gives rise to deterioration of the metal, and renders it more brittle, an effect proved by removing in the lathe a thin collar of the metal surrounding the punched hole, which collar proved harder and less ductile under pressure than a similar one removed from the same metal perforated by boring. The detached collarette of metal at the upper part of the punched core varies inversely with the amount of play left between the punch and the matrix, and disappears when this play is equal to about one-fourth of the thickness of the metal punched.

After discussing the question of shearing tests as a substitute for breaking-strain tests, the author concludes by dealing with the best form of punch for producing a perfectly cylindrical aperture without deterioration of the punched metal. For fine work, such as punching boiler plate, he finds the

best effect produced by a punch in the form of a stepped screw, the successive cutting edges of which gradually widen the upper part of the otherwise conical hole with a minimum of deformation. In the case of ordinary rivet holes, where an inferior degree of precision is required, a punch with one V-shaped step will, he claims, produce satisfactory results.

### A TIE EXTRACTOR AND REPLACER.

An ingenious device for extracting and replacing ties is shown in the accompanying engraving. In

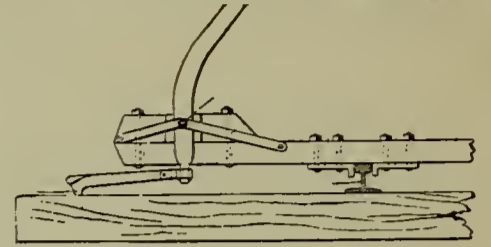

Fig. 1 the machine is shown in operation pulling out a tie. The machine is placed across the rails directly over the tie that is to be removed; the dog is then driven into the tie, as shown, and the lever is then drawn down firmly, and thus any tie can be removed with ease from under the rails without disturbing or raising the track or digging out the roadbed. In Fig. 2 the machine is shown replacing a tie. This machine, which has done excellent work in actual service, is made only by the Smith Manufacturing Company, Columbus, O

### PERSONAL.

Mr. William Cormack has resigned as master car builder of the Wisconsin Central.

Mr. William Robb, master mechanic of the Louisville & Nashville at Decatur, Ala., is dead.

Mr. J. W. Stokes has resigned as master mechanic of the Detroit & Lima Northern at Tecumseh, Mich.

Mr. Franklin Gardner, organizer of the Carlisle Car Company, died in Carlisle, Pa., Nov. 18. Aged 78 years.

Mr. C. E. Slayton has been appointed division master mechanic of the Chicago Great Western at Dubuque, Ia.

Mr. C. H. Sutherland, mechanical engineer of the Grand Trunk Railway, died very suddenly a short time ago.

Mr. John Hoffman has been appointed purchasing agent of the Bangor & Portland, with office at Bangor, Me.

Mr. C. A. De Haven has been appointed master mechanic of the Omaha, Kansas City & Eastern at Stanberry, Mo.

Mr. C. A. Coffee has been appointed master mechanic and car builder of the Oconee & Western, vice A. J. Mentor.

Mr. John Stranahan has been appointed traveling engineer of the Delaware & Hudson, with headquarters at Oneonta, N. Y.

Mr. B. C. Gesner has been appointed general air brake inspector of the Intercolonial, with headquarters at Moncton, N. B.

Mr. Charles B. Cramer has been appointed foreman of the engine houses at Allegheny, Pa., of the Pennsylvania Railway.

Mr. J. C. Chapman, inventor of the Chapman valve and other devices, died on Nov. 4 at his home in Boston, Mass., aged 76 years.

Mr. Edward T. Worman has been appointed general foreman of the shops of the Louisville, Evansville & St. Louis, at Princeton, Ind.

Mr. Martin Brown has been appointed master mechanic of the Washburn, Bayfield & Iron River, with headquarters at Washburn, Wis.

Mr. W. J. Spain of the Roanoke Machine Works has been appointed general foreman of the Atlantic & Danville shops at Lawrenceville, Va.

Mr. John Foulk has been appointed master mechanic of the Litchfield, Carrollton & Western, with office at Litchfield, Ill., vice Mr. B. F. Bond.

Mr. D. P. Kellogg has been appointed superintendent of air equipment and coach trucks of the Southern Pacific, with headquarters at Oakland, Cal.

Mr. T. J. Shellhorn has been appointed master mechanic of the Fort Worth & Rio Grande, with office at Fort Worth, Tex., vice B. G. Plummer, resigned.

Mr. John Forster, Jr., has resigned as master me-

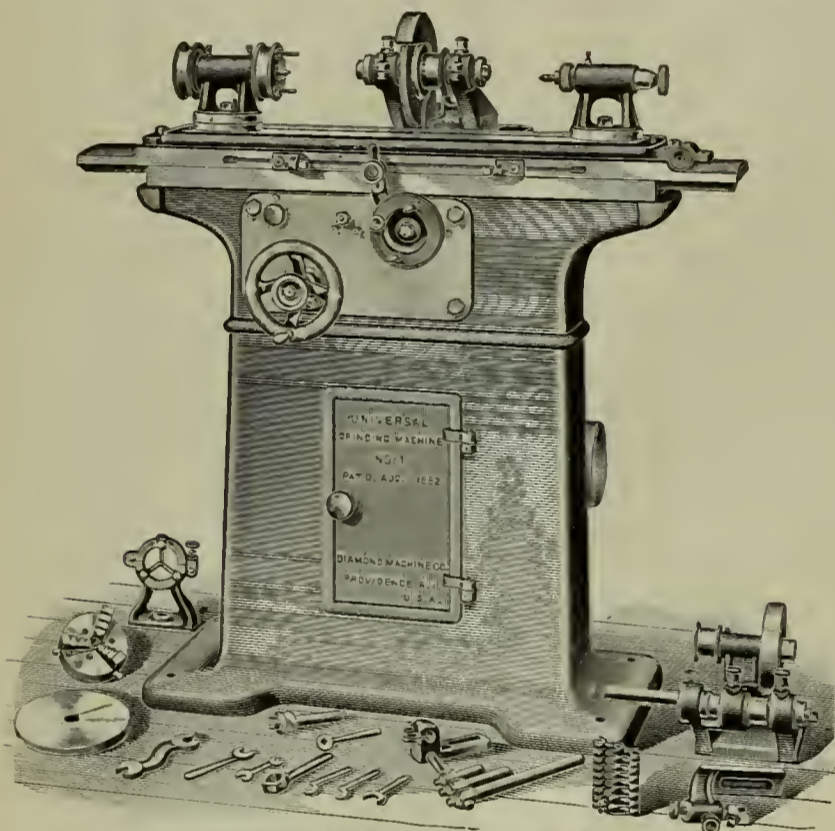

A NEW UNIVERSAL GRINDER.

taper hole. If work is to be ground on dead centers, the spindle may be locked and the work revolved by means of a pulley on the front end of the spindle. There is a special device for taking up the wear.

The foot stock is clamped to the swivel table. The spindle is adjusted by a screw and a spring is provided to adjust the spindle if the work expands.

All this company's Universal grinders are provided with pump and water tank, and ample provision is made for taking care of the water. Universal grinders of the Diamond Machine Co. are made in five sizes, as follows: No. 1 takes work 18 in. long, 8 in. diameter; No. 2 takes work 24 in. long, 10 in. diameter; No. 3A takes work 30 in. long, 12 in. diameter; No. 3B takes work 40 in. long, 12 in. diameter; No. 3C takes work 60 in. long, 12 in. diameter.

The "Pacific Coast Limited" has been placed in service between Chicago and San Francisco by the Chicago & Alton, the St. Louis, Iron Mountain & Southern, the Texas Pacific, and the Southern Pacific. The train is made up of a composite car, a compartment sleeper, standard sleepers and a diner. It is a handsome train and received a handsome christening when on Nov. 4 it carried an invited party of railway men from Chicago to Joliet and return. The fittings and finish of the cars making up the train are of the finest nature.

The Baltimore & Ohio has placed in service a brand new "Royal Blue Limited" train between

chanic of the Atchison, Topeka & Santa Fe at La Junta, and H. E. Clacas of Pueblo has been appointed as his successor.

Mr. H. J. White has been appointed Master Mechanic and Superintendent of Transportation of the Boyne City & Southeastern, with headquarters at Boyne City, Mich.

Mr. Robert H. Harrison, foreman of the Pittsburg, Fort Wayne & Chicago shops, at Fort Wayne, Ind., has resigned. He has been an employee for 40 years, and retires on a pension.

On the Southern Pacific the position of fuel expert, held by J. C. Martin, has been abolished. Mr. Martin has been appointed road foreman of engines, vice W. H. Russell, assigned to other duties.

Mr. John Medway, formerly superintendent of motive power of the Fitchburg, has accepted the position of master car builder for Swift & Co., with headquarters at the Union Stock Yards, Chicago.

Mr. E. J. Dedman has been appointed chief clerk in the office of the general superintendent of the El Paso & Northwestern, with office at El Paso, Tex. He also has charge of the purchasing department.

Mr. T. M. Downing, late master mechanic of the Columbus, Sandusky & Hocking, has been appointed master mechanic of the Detroit & Lima Northern at Tecumseh, Mich., vice Mr. J. W. Stokes, resigned.

Mr. Frank Miller, who has been lately in the employ of the Baldwin Locomotive Works, has returned to his old position as traveling engineer of the Cincinnati, Hamilton & Dayton, with headquarters at Lima, O.

Mr. Wm. Percy has been appointed master car builder of the Wisconsin Central, with headquarters at Stevens Point, Wis., vice W. Cormack, resigned. Mr. Percy has hitherto been general foreman of the Brainerd shops of the Northern Pacific.

Mr. Norman E. Sprowl has been appointed division master mechanic of the New Jersey Central division of the Central Railroad of New Jersey in charge of all shops and machinery, with office at Elizabethport, N. J. The appointment dates from Nov. 15.

Mr. D. K. Fullerton, heretofore assistant foreman of the Northern Pacific at Brainerd, Minn., has been appointed general foreman of the Brainerd shops to succeed Mr. William Percy, who was recently appointed master car builder of the Wisconsin Central.

The Lake Shore & Michigan Southern management has abolished the office of master car painter and Mr. Geo. R. Cassie, who has held that position for several years, has become connected with the Carrara Paint Company and will travel in its interests through the United States.

Mr. H. H. Vaughan, mechanical engineer of the Philadelphia & Reading Ry., and previously mechanical engineer of the Great Northern, has accepted the position of mechanical engineer of the Q. & C. Company. His headquarters will be at that company's Chicago office, Western Union building.

Mr. W. H. Harris, master mechanic at the De Soto shops of the St. Louis, Iron Mountain & Southern, has tendered his resignation, to take effect as soon as his successor is appointed. For over a year Mr. Harris has been in poor health, and recently has been confined to his home. He has been with the company for over 20 years.

Mr. J. S. Turner, heretofore superintendent of motive power of the West Virginia Central & Pittsburg, has been appointed superintendent of motive power of the Union Pacific, Denver & Gulf, vice M. F. Egan, resigned. Mr. Turner's headquarters will be in Denver. The statement current that Mr. Turner was to enter the service of a pneumatic tool company, is incorrect.

Mr. W. C. Ennis, for twenty years master mechanic and car builder of the New York, Susquehanna & Western R. R., has connected himself with the Chicago Pneumatic Tool Company, and will travel from the New York office of that company. Mr. Ennis enjoys a wide acquaintance among the railroad men of this country, and will be a valuable addition to the working force of the Chicago Pneumatic Tool Company.

Mr. William B. Baldwin, division master mechanic of the Illinois Central, at McComb City, Miss., was killed at Areola, La., Nov. 5. The accident, as explained to a New Orleans Picayune reporter by the engineer in charge of the train, was clearly shown to have been avoidable. Mr. Baldwin was riding from McComb City to New Orleans on engine No. 930, which had just come out of the shops at the former city, and as the train ran into Areola he saw two red signal lights, which he evidently took to be upon the rear of a train standing upon the main line, and he and the fireman, George Maccullum, jumped. Mr. Baldwin was thrown violently against a switch stand and died instantly. The latter, however, escaped with no serious injury. The signal lights which Mr. Baldwin saw were, in fact, on the caboose of a freight train on the siding.

## SUPPLY TRADE NOTES.

—The Niles Tool Works Company has completed the last of fourteen 10-inch gun carriages.

—The Modern Machine Company has been incorporated in Cleveland, O., with a capital of \$10,000.

—The Chicago Grain Door Company furnishes grain doors and "Security" lock brackets for the 500 new "Soo Line" cars.

—The decision of the lower court sustaining the patents of the United States Mitis Company has been affirmed in the court of appeals.

—The placing of an order for 2500 tons of 83-lb. steel rails for a railroad in Ireland with the Maryland Steel Company is a very suggestive fact.

—The Vulcan Iron Works of Toledo have moved into new offices at 916 Summit street and report business very good.

—Bement, Miles & Co. are building two large gun lathes on an order from England. This company is now employing nearly 900 men and will, in addition, run a night force.

—The Drake & Weirs roof is to be put on 200 box cars being built by the Union Car Co. for the Fitchburg Ry., and also on 200 cars being built by Wells & French for the St. Paul & Duluth Ry.

—Gould & Eberhardt, Newark, N. J., have shipped eight drills built for United States government arsenals. They have other governments orders for shapers and automatic gear cutting machines.

—The Chicago Pneumatic Tool Company is breaking the record in the matter of growth of business. Its business is now stated to be double what it was a year ago and is increasing every week. It is a remarkably successful concern.

—The stockholders of the American Brake Company, St. Louis, Mo., have voted to consolidate with the Westinghouse Air Brake Company. Two \$50 shares of the latter company are given for three \$100 shares of the first named.

—The Cambria Iron Company has leased all its property to the recently organized Cambria Steel Company. No change is made in the official force and the step has doubtless been taken to give this immense concern a name more in keeping with its business.

—J. A. Fay & Co., Cincinnati, O., manufacturers of high grade woodworking machinery, have just sent us an elegant folder, printed in red and green, showing some fifty of their new improved machines, for working wood, and they advise us that if any one writes for one, stating that this paper told him to do so, they will send one free, postpaid.

—Manning, Maxwell & Moore are now selling the machine tools of the Pntnam Machine Company, of Fitchburg, Mass., instead of the product of the Pond Tool Works as heretofore. They are also selling agents for the Betts Machine Company, of Wilmington, Del.; the Bausch & Harris Machine Tool Company, of Springfield, Mass., and the Fifield Tool Company, of Lowell, Mass.

—The Harrison Dust Guard Co. of Toledo recently equipped 2700 cars with their dust guard in one month. They have also furnished the Ohio Falls Car Co., the Illinois Car & Equipment Co., the Lenoir Car Company, the Jackson & Sharp Car Co., the Barney & Smith Car Co., the Elliott Car Co., the Missouri Car & Foundry Co. and the Michigan Peninsular Car Co., a large number of these guards.

—Gould & Eberhardt, Newark, N. J., are just shipping eight of their improved drills to the U. S. government at Rock Island, Ill., and some for Brooklyn, N. Y. They also have a number of other government orders for their patent extension base shapers for the various arsenals, as well as for some automatic gear cutting machines. The works have been very busy for some time back working on orders for the improved tools.

—The advertising departments of the various Westinghouse companies have been consolidated into one under the management of Mr. Arthur Warren, formerly in charge of the advertising department of the Westinghouse Electric & Manufacturing Company. This work is now being pushed with much energy and also, as a reference to the advertising pages of this number of the Railway Master Mechanic will show, with skill and good taste.

—It is an "off year" when the Dayton Malleable Iron Co. is not building an addition to its works and off years have been scarce in its history. It is now finishing an enlargement which will add nearly 30 per cent to its capacity. There is still some land left adjacent to its location, but not much. This company has fairly earned its prosperity for it has always sincerely (and successfully) endeavored to produce the very best grade of malleable iron and it has also established a reputation for fulfilling its agreements in the matter of deliveries.

—During the past summer the Joseph Dixon Crucible Company of Jersey City, N. J., have added an extension to their pencil factory, 40 by 90 ft., three stories high. The same is driven by electric power from gener-

ator placed in the main factory. No expense has been spared in the equipment of this addition in the way of up-to-date elevators, furnaces, dry-rooms, etc. The company will also put down an artesian well, several hundred feet in depth, for a supply of water for factory use, and sometime during 1899 various other additions will be built to the Dixon company's very extensive plant.

—The thirty new freight locomotives ordered by the receivers of the Baltimore & Ohio Railroad about three months ago, twenty of which are from the Baldwin Locomotive Works and ten from the Pittsburg Locomotive Works, have been delivered and are now in service. These engines are the same type that have been used between Cumberland and Baltimore, and over one hundred of them are now in service. They are the Consolidation type with 21x27 inch cylinders and were constructed from designs furnished by the motive power department of the Baltimore & Ohio Railroad.

—The Russell Snow Plow Co. advise us that they have recently received orders as follows: From the New York Central & Hudson River Railroad Company for one Russell wing-elevator snow plow, size No. 2, and for one Russell standard snow plow, size No. 2 for the western division of their main line; also for two Russell wing-elevator snow plows, size No. 2, for their Rome, Watertown and Ogdensburg line; from the Saginaw, Tuscola & Huron Railroad Company for one Russell snow plow, size No. 3, with air flanger; from the Washington County Railway for two Russell snow plows, with hand flanger, size No. 4, and for one ditto, size No. 3.

—The humming of the wild winds through Page wire fences in all the states and territories has caused poetic vibrations in the mind and soul of Dr. J. H. Reynolds, manager of the advertising department of the Page Woven Wire Fence Company. He has produced a ballad concerning the Page fence, its making and its use, which shows correct feeling for rhyme and rhythm. The ballad has been set to music by T. P. Rinchart and is issued under the title "A Page Fence Waltz." The music looks musical and will no doubt be sung in thousands of homes all over the country. On the same sheets a stirring "Page Fence March" by the same composer is given.

—Mr. T. W. Harvey, Jr., has opened an office in the Monadnock Block, Chicago, Room 1256, for the sale of railway supplies. Mr. Harvey was for some time superintendent of the Harvey Car Works at Harvey, Ill., and has a good acquaintance with railway officials, especially in the west. He handles the Harvey steel truck and the Harvey steel bolster, also car axles, turnbuckles, journal bearings and general railway supplies. In addition to these he represents a large car-building concern, and the Rouemus draft gear and is the general agent of the Payne Railway Signal, Switch & Equipment Company, whose train order and block signal was illustrated in the November number of this paper. He also expects to handle car lumber. Mr. Harvey has, it will be seen, an excellent line of supplies and is meeting with much encouragement at the very beginning of his work.

—The Damascus Steel Company, Pittsburg, Pa., is the name of the recently reorganized Pittsburg Tool Steel Company. Mr. J. C. Jamison is president of the new company; Mr. H. J. Williams, secretary, and Mr. Walter J. Scott, superintendent. The Damascus brand of steel for lathe, chisel and die work has been favorably known for some years, and the new company has put in additional facilities which enable it to turn out all sizes of tool steel, in bars, and to make forgings of tool steel, bessemer, open hearth and nickel steel, such as crank shafts, spindles, locomotive wrists, die block axles, and other kinds of work. It makes a specialty of large round bars of the proper temper and quality, for rolls, milling cutters and discs of all sizes, and heavy blocks for cutting and drop force dies. The company makes a nickel steel which has shown remarkable properties, a recent test showing a tensile strength of 237 pounds to the square inch.

—Contracts for tools for the new shops of the Chicago Great Western Railway at Oelwein have been let as follows: With Manning, Maxwell & Moore for one 15-ton electric traveling crane, and one 65-ton electric engine hoist of special design; with the Industrial Works, of Bay City, Mich., for one 125-ton electric transfer table, with a maximum speed of 400 ft. per minute; with the American Hoist & Derrick Co., of St. Paul, for one 5-ton electric boom crane; with the Niles Tool Works Co., S. A. Woods Machine Co., and the Robinsou & Cary Co. for various machine tools; with the Arnold Electric Station Co., for boilers, engines, dynamos, motors, heating plant and air compressor.

—The control of the Pond Machine Tool Co., of Plainfield, N. J., passed, during the month, from Manning, Maxwell & Moore to the Niles Tool Works interests. Officers of the Pond Works have been elected as follows: Thos. Gaff, president; Robt. C. McKinney, treasurer; W. R. Clark, secretary. It is understood that Mr. Charles A. Moore and Mr. A. C. Stebbins will hold the positions of vice-presidents, and that Mr. Stebbins will continue as general superintendent of the Plainfield works.

# THE NEW HORNISH MECHANICAL LOCOMOTIVE BOILER CLEANER

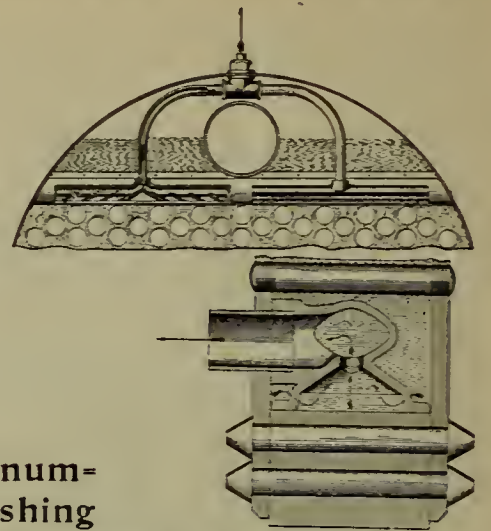
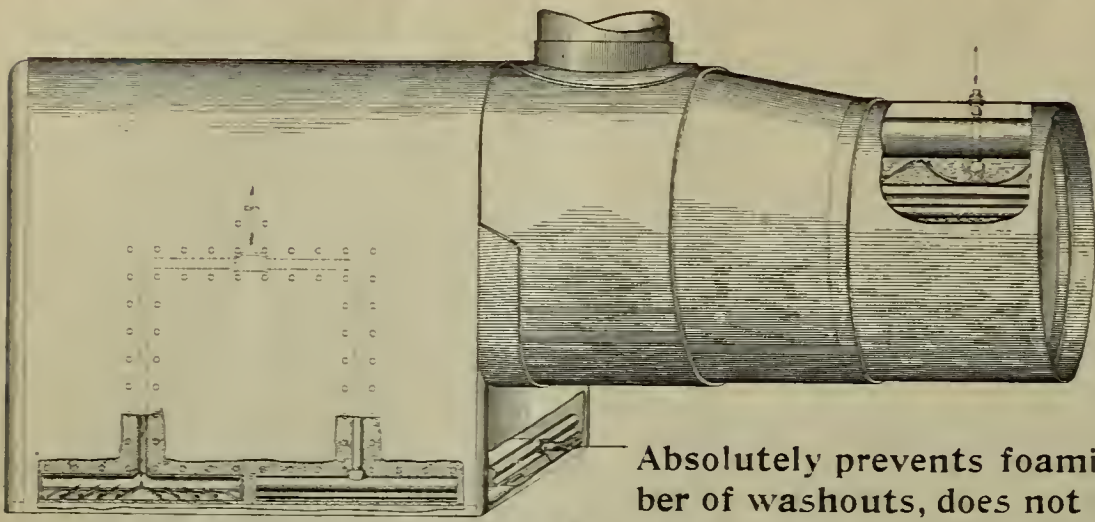

Absolutely prevents foaming, reduces the number of washouts, does not interfere with washing out the old way, and avoids the use of compounds. Send for Blueprints and Descriptive Pamphlet to THE HORNISH MECHANICAL BOILER CLEANER CO., 908-909 Masonic Temple, Chicago, U.S.A.

## THE CLOUD STEEL TRUCK FRAME

FOR FREIGHT CARS OF ALL KINDS AND LOCOMOTIVE TENDERS.

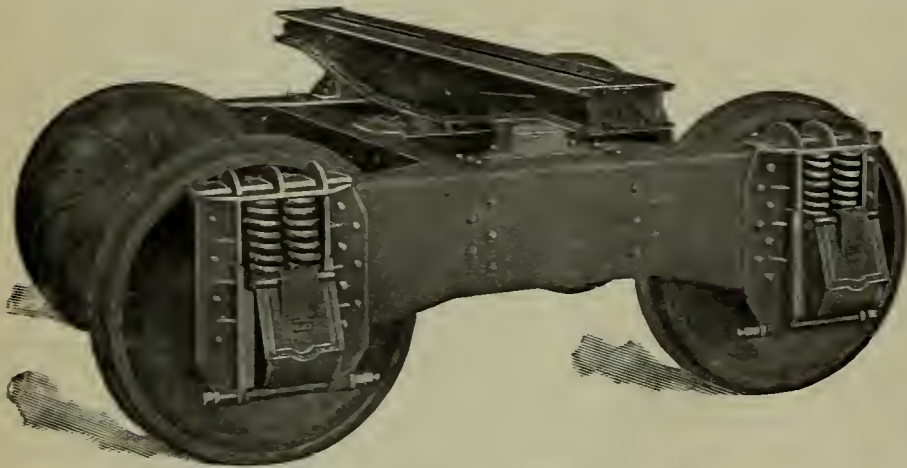

THE CLOUD STEEL TRUCK FRAME WITH BETTENDORF I BEAM STEEL BODY BOLSTER

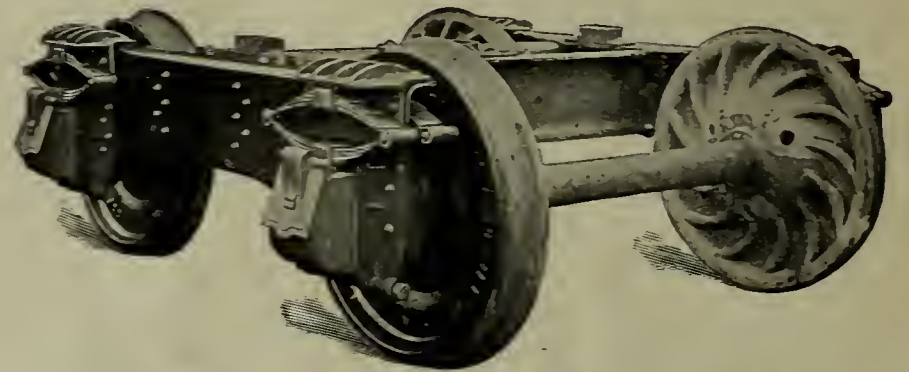

THE CLOUD STEEL TRUCK WITH ELLIPTIC SPRINGS—FOR LOCOMOTIVE TENDERS, STOCK CARS, ETC.

### SPECIAL ADVANTAGES.

Fewest Parts—Straight Line Flanging—Ease of Making Repairs—Perfect Spring Action—Use of Small Section Coil Springs, insuring thorough tempering—Wide Bearing of Pedestals against Boxes—Use of Elliptic Springs instead of coil when desired—Best Materials and Workmanship.

"These elements—lightness, stiffness, squareness, are earning money every mile that a truck runs"—*The Railroad Gazette*. The Cloud truck is in extensive and successful use. Send for further particulars regarding this and our I beam steel bolsters. Works at South Chicago.

### Bettendorf I Beam Steel Bolsters



SIDE VIEW BODY BOLSTER.



BOTTOM VIEW BODY BOLSTER.

THE CLOUD STEEL TRUCK CO., 1425 Old Colony Building. Chicago.

# THE GRAVITY CAR COUPLER.

## AN ABSOLUTELY AUTOMATIC COUPLER.

Cuts the Cost of the Vertical Plane Type in Two.



NO PINS TO BUY,

NO KNUCKLES TO BREAK.

THIS COUPLER takes the ordinary Link. Is always ready to couple. Works on heaviest curves. Gives a center draft. Is compact, light and strong.

The latch cannot jump up, or creep up, and release link by motion of the cars.

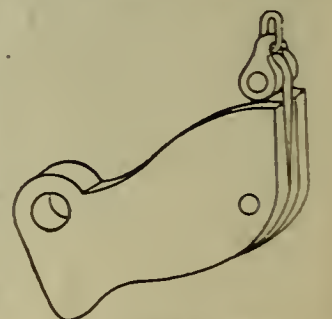

The Latch.

IT HAS STOOD THE SEVEREST SERVICE TESTS IN MOUNTAIN AND YARD SERVICE FOR MONTHS. WEIGHT, COMPLETE, 145 LBS.

For details address

The Gravity-Car Coupling Co.,

Colorado Springs, Col.



