

HAROLD E. EDGERTON

PAPERS

MC 25

Series III

Laboratory Notebooks

Number 18

Dated Jan 28, 1948 to July 1948



Notebook # 18

Filming and Separation Record

9 unmounted photograph(s) negative strip(s)18 unmounted page(s)
(notes, drawings, letters, etc.)was/were filmed where originally located between page and .
inside front cover

Item(s) now housed in accompanying folder.



Calibration of PM 931 Tube with
Naphthalene Using a Radio Active Source

A one curie radio active source from Los Alamos was used to make a direct calibration of the 931-Naphthalene combination. With the source at a six inch distance from the Naphthalene, a current of 25 microamperes was measured. The number of gamma rays per second from the radio active source was assumed to be 3.7×10^{10} .

We will now calculate the gamma ray flux density that is necessary to produce a $5/8$ inch deflection on the cathode ray tube screen. A voltage of 125 is required across a 1000.ohm input resistor for the above condition. Thus the PM current must be 125 milliamperes. The necessary gamma ray flux density can then be calculated from the calibration data.

$$\text{Sensitivity} = \frac{25 \times 10^{-6}}{3.7 \times 10^{10} / 4\pi(6 \times 2.54)^2} = 20 \times 10^{-13} \text{ amp/Gamma ray/cm}^2$$

then for 125 ma the pickup will require

$$\frac{.125}{20 \times 10^{-13}} = 6.3 \times 10^{10} \text{ gamma rays per second per cm}^2$$

The corresponding gamma ray intensity for the 935 photo electric cell is a million times larger.

The absorption and scattering of the gamma rays reduces the flux as it goes from the bomb to the pickup. Assuming a m.f.p. of 300 yards, this reduction factor is computed to be

$$e^{-1300/300} = 0.013$$

This is the factor that was used in calculating the gamma ray flux that comes from the bomb. For example with the 931 PM tube;

$$\text{Flux} = 6.3 \times 10^{10} \cdot 4\pi(1300 \times 36 \times 2.54)^2 \times \frac{1}{.013} = 8.32 \times 10^{23} \text{ gamma rays per second.}$$

The corresponding figure for the 935 photo electric cell is a million times larger.

There is considerable uncertainty about the 300 yard mean free path value that is used above. Should any other value be found later to be more accurate, recalculation of the bomb flux output can be made to correspond.

Calibration of PM 931 Tube with
Naphthalene Using a Radio Active Source

A A one curie radio active source from Los Alamos was used to make a direct calibration of the 931-Naphthalene combination. With the source at a six inch distance from the Naphthalene, a current of 25 microamperes was measured. The number of gamma rays per second from the radio active source was assumed to be 3.7×10^{10} .

We will now calculate the gamma ray flux density that is necessary to produce a 5/8 inch deflection on the cathode ray tube screen. A voltage of 125 is required across a 1000.ohm input resistor for the above condition. Thus the PM current must be 125 milliamperes. The necessary gamma ray flux density can then be calculated from the calibration data.

$$\text{Sensitivity} = \frac{25 \times 10^{-6}}{3.7 \times 10^{10} / 4\pi(6 \times 2.54)^2} = 20 \times 10^{-13} \text{ amp/Gamma ray/cm}^2$$

then for 125 ma the pickup will require

$$\frac{.125}{20 \times 10^{-13}} = 6.3 \times 10^{10} \text{ gamma rays per second per cm}^2$$

The corresponding gamma ray intensity for the 935 photo electric cell is a million times larger.

The absorption and scattering of the gamma rays reduces the flux as it goes from the bomb to the pickup. Assuming a m.f.p. of 300 yards, this reduction factor is computed to be

$$e^{-1300/300} = 0.013$$

This is the factor that was used in calculating the gamma ray flux that comes from the bomb. For example with the 931 PM tube;

$$\text{Flux} = 6.3 \times 10^{10} \frac{4\pi(1300 \times 36 \times 2.54)^2}{.013} = 8.32 \times 10^{23} \text{ gamma rays per second.}$$

The corresponding figure for the 935 photo electric cell is a million times larger.

There is considerable uncertainty about the 300 yard mean free path value that is used above. Should any other value be found later to be more accurate, recalculation of the bomb flux output can be made to correspond.

Sensitivity estimates are based upon these assumed sensitivity values from the ^{RCA. tube handbook.} ~~handbook, etc.~~

935 phot cell. 40 microamperes/lumen.
cathode area = 0.6 square inches.

931 Photomultiplier, 40 amperes/lumen
cathode area = .25 square inches.
(Estimated for 150 volts per stage).

Searchlight factor = 600 (measured)

931 naphthalene, 8.6×10^{-13} amperes.
~~20 microamperes~~ per
gamma ray per second
per square cm.

(calibrated with a Curie radium source which is assumed to emit 8.5×10^{10} gamma rays per second)

935 naphthalene, assumed to be 10^6
~~+ $\frac{1}{10}$ that of~~ 931 naphthalene combination
less sensitive than the

~~Distance~~
Light ~~reduction~~ ^{transmission} per mile = ~~80~~ ⁸⁰ percent
(Values given by O'Brien ~~et al.~~)

Total Light ~~reduction~~ ^{transmission} Pasgebi-Parry = $.8^{20.2} = 1.4\%$
" " Comon-Parry = $.8^{16.1} = 3.32\%$
" " Runit-Parry = $.8^{10.3} = 10.1\%$

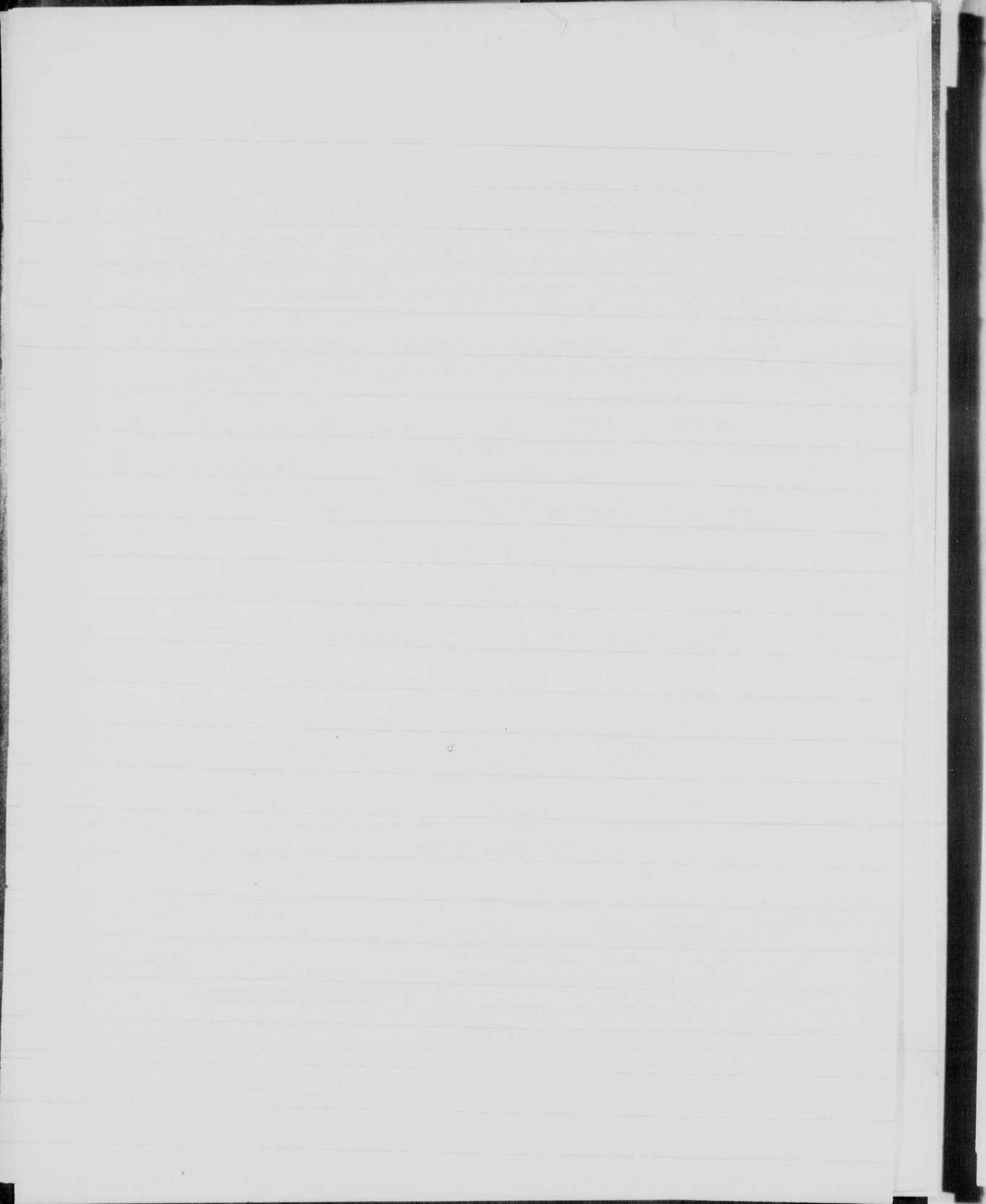

cell current in 4 amp.

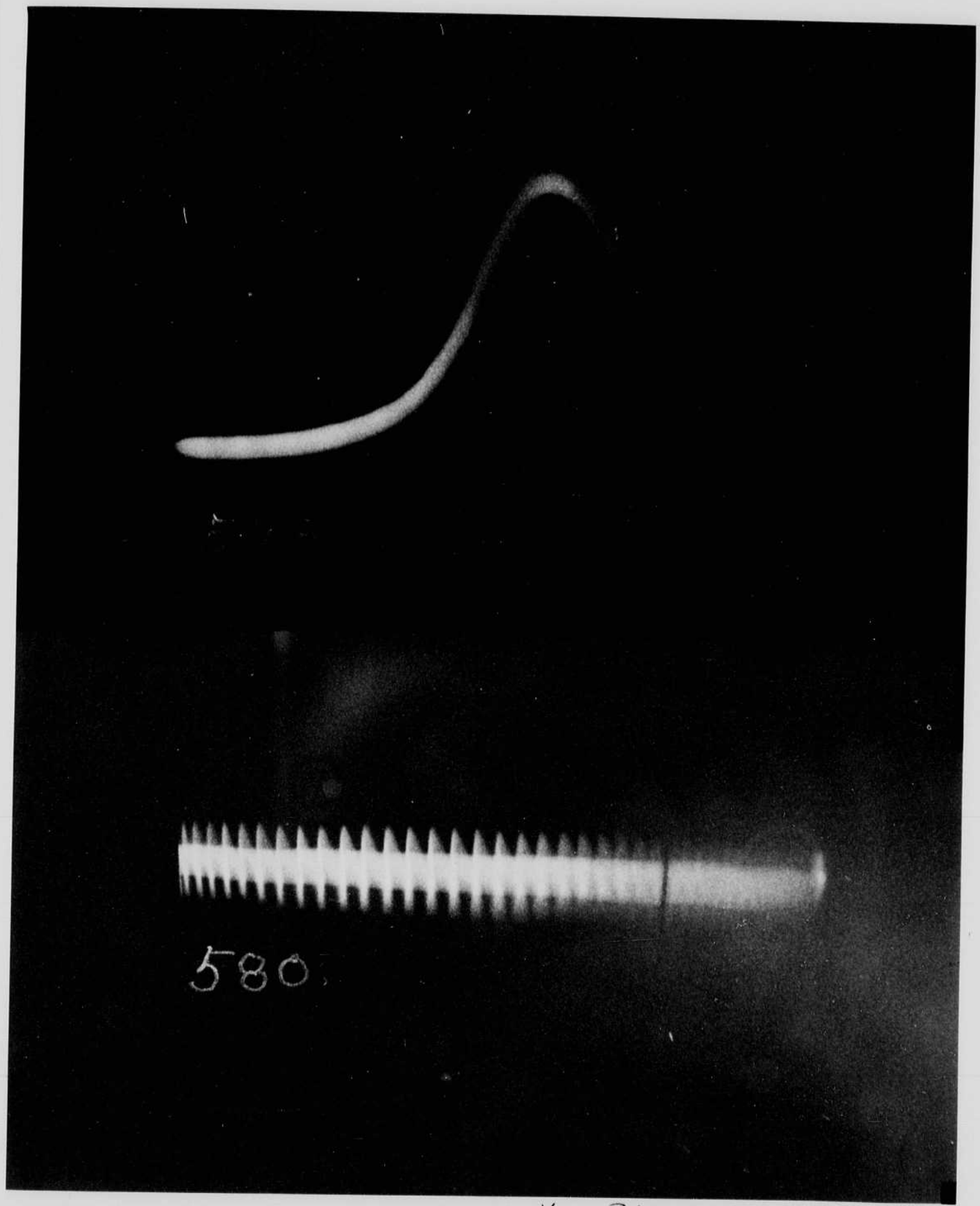

580.

V. - PARRY

907

INTENSITY
0.2



Cell current in 4 amp.

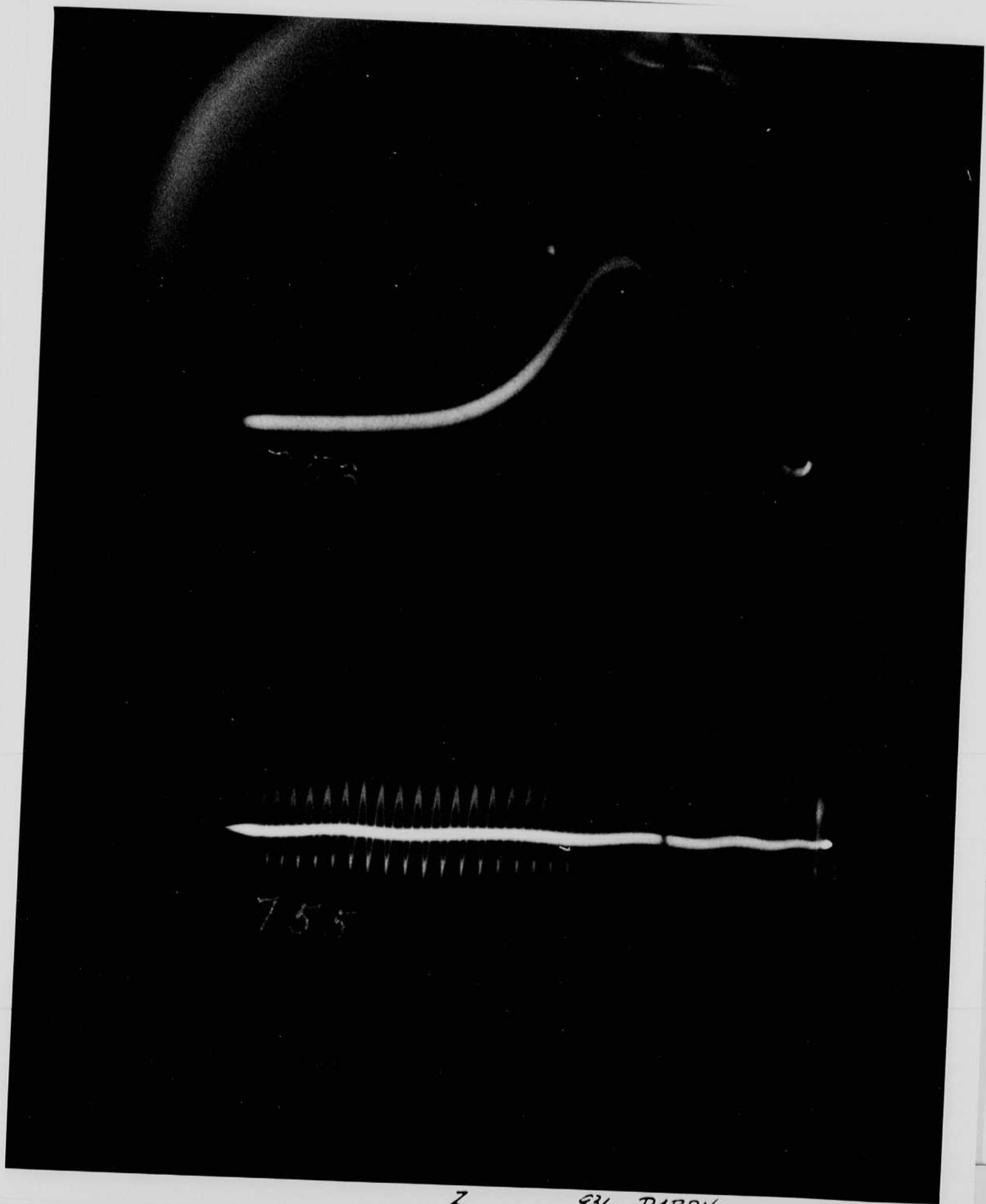



Cell current in 4 amp.

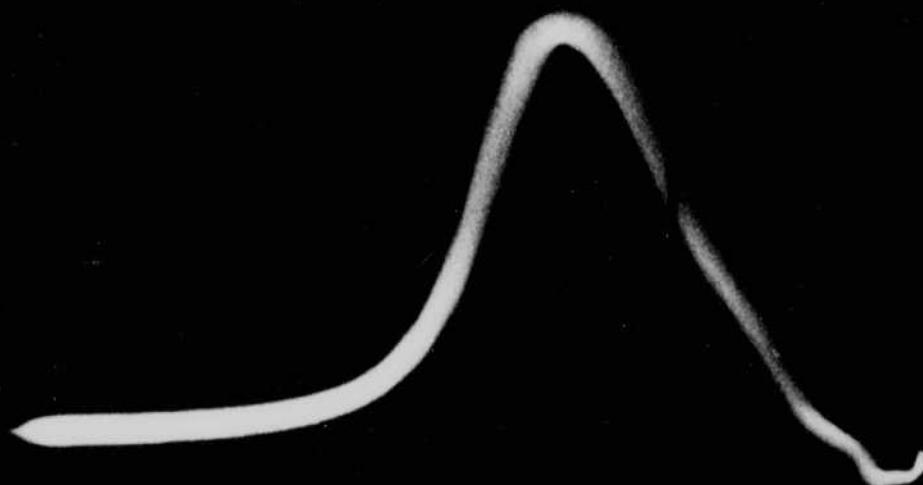

579



588



cell current in 4amp.



402

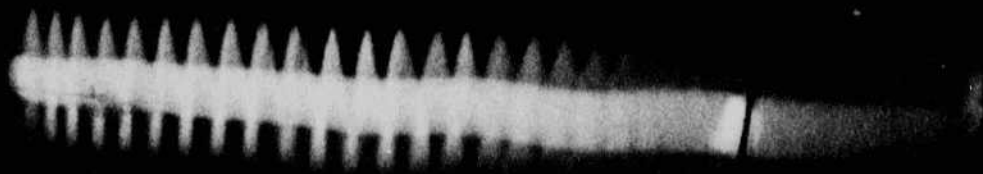

365

X-PARRY



Cell current in 4amp.

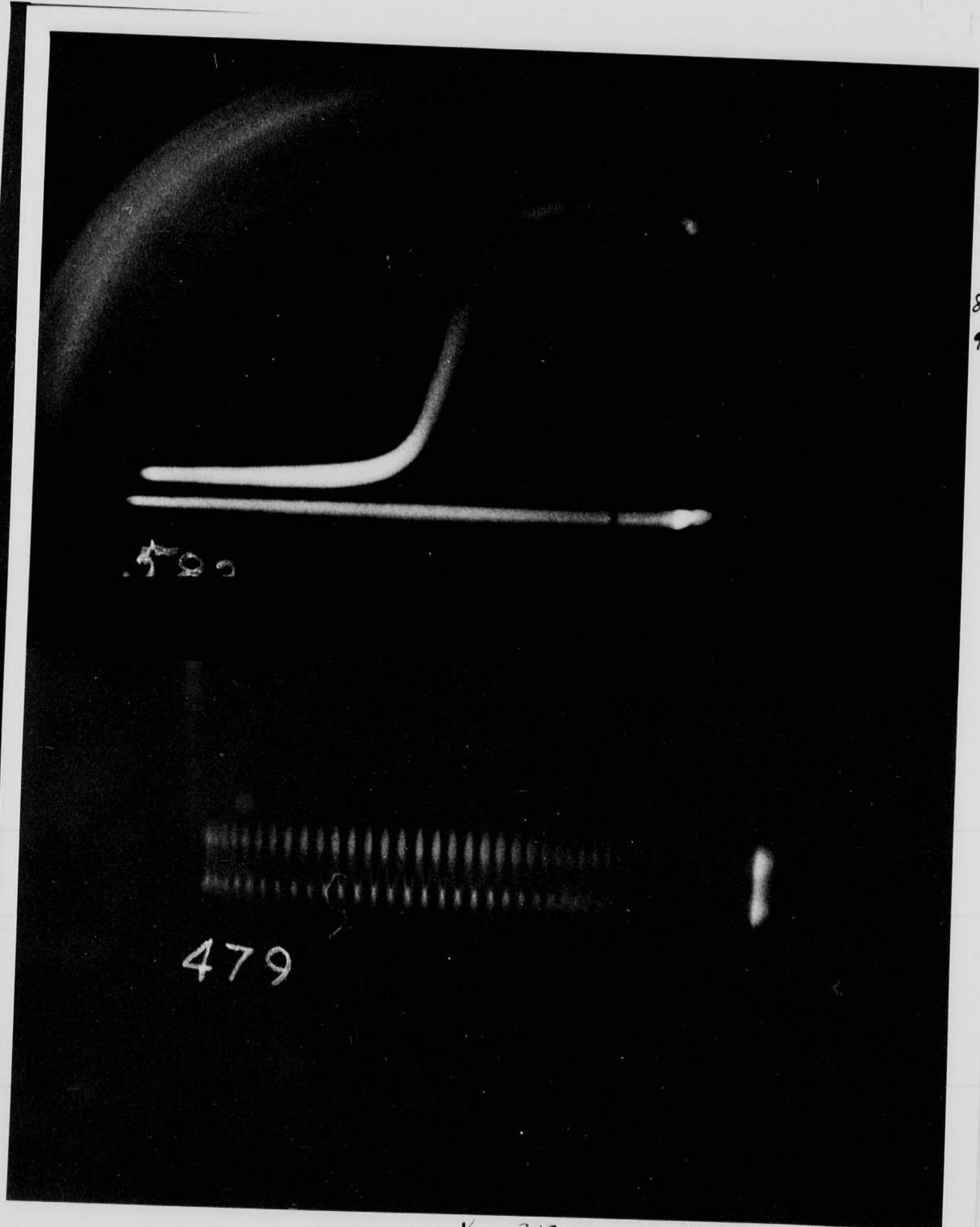

89
91

479

y 900 S.L.

907



Cell current in 4amp.

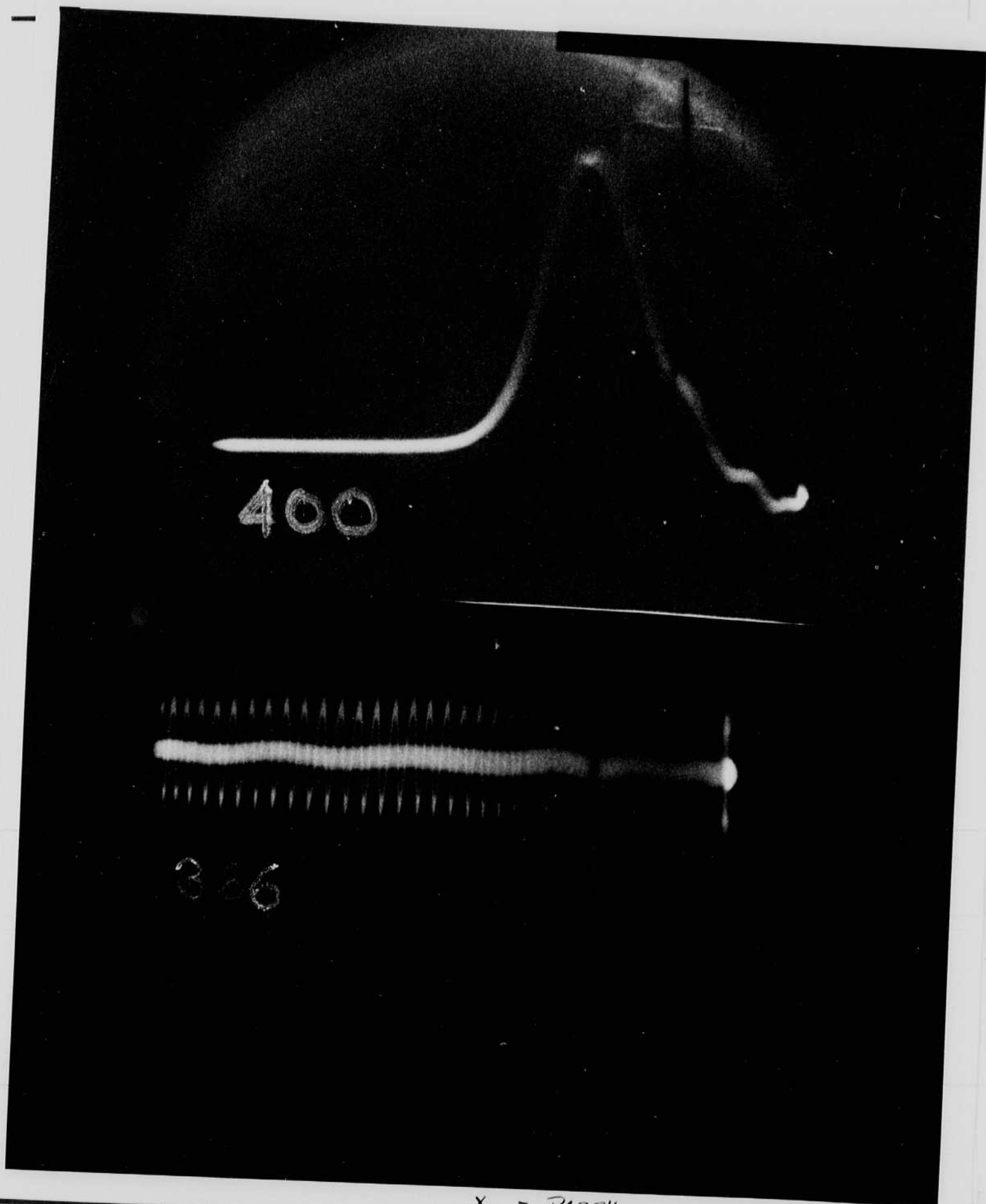

x - PARRY

z 935 S.L.

97



Cell current in 4amp.

0 20 40 60 80 100 120 140 160

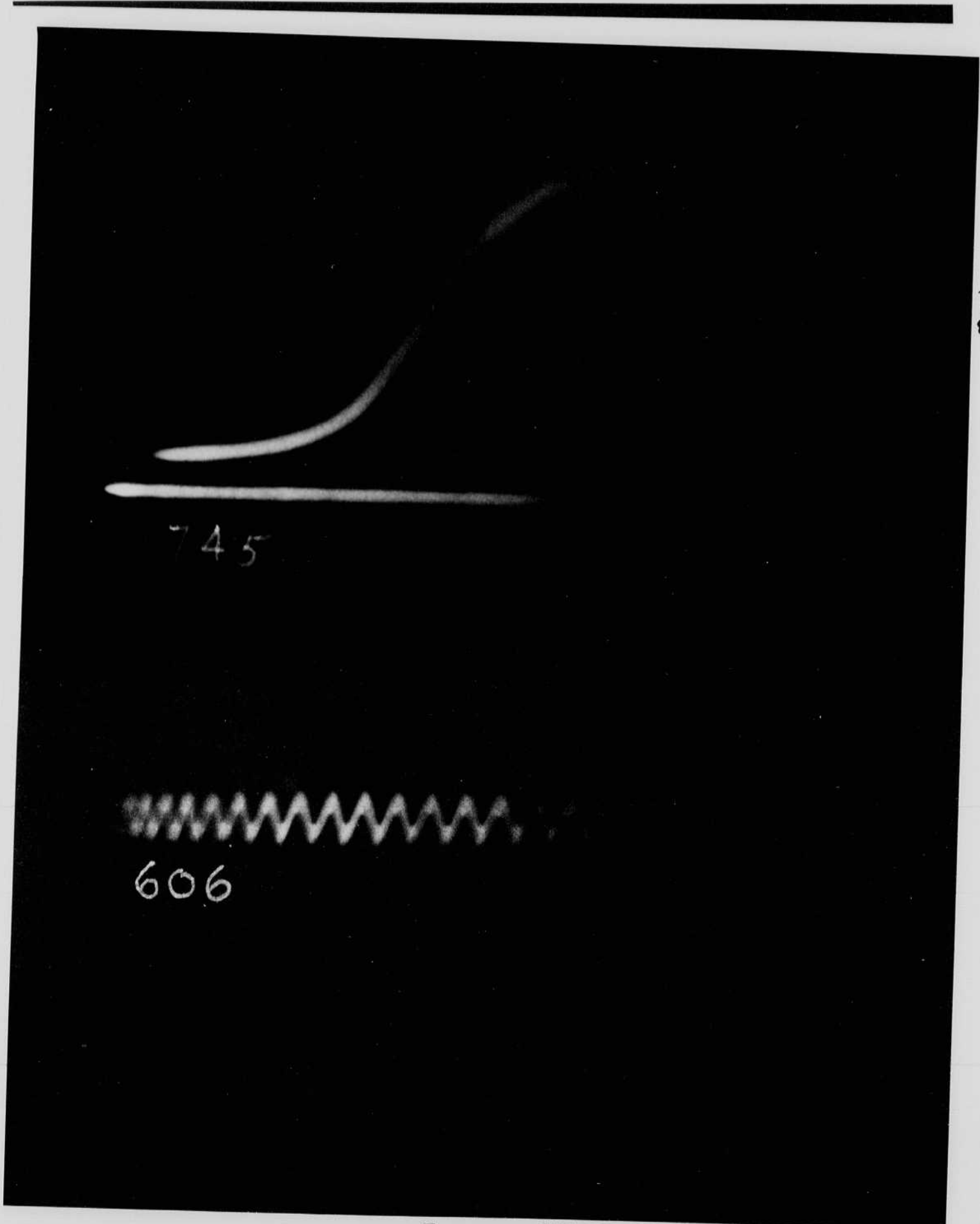

745

606

76
87



2

93.5 S.L.

95



Cell current in 4 Amp.

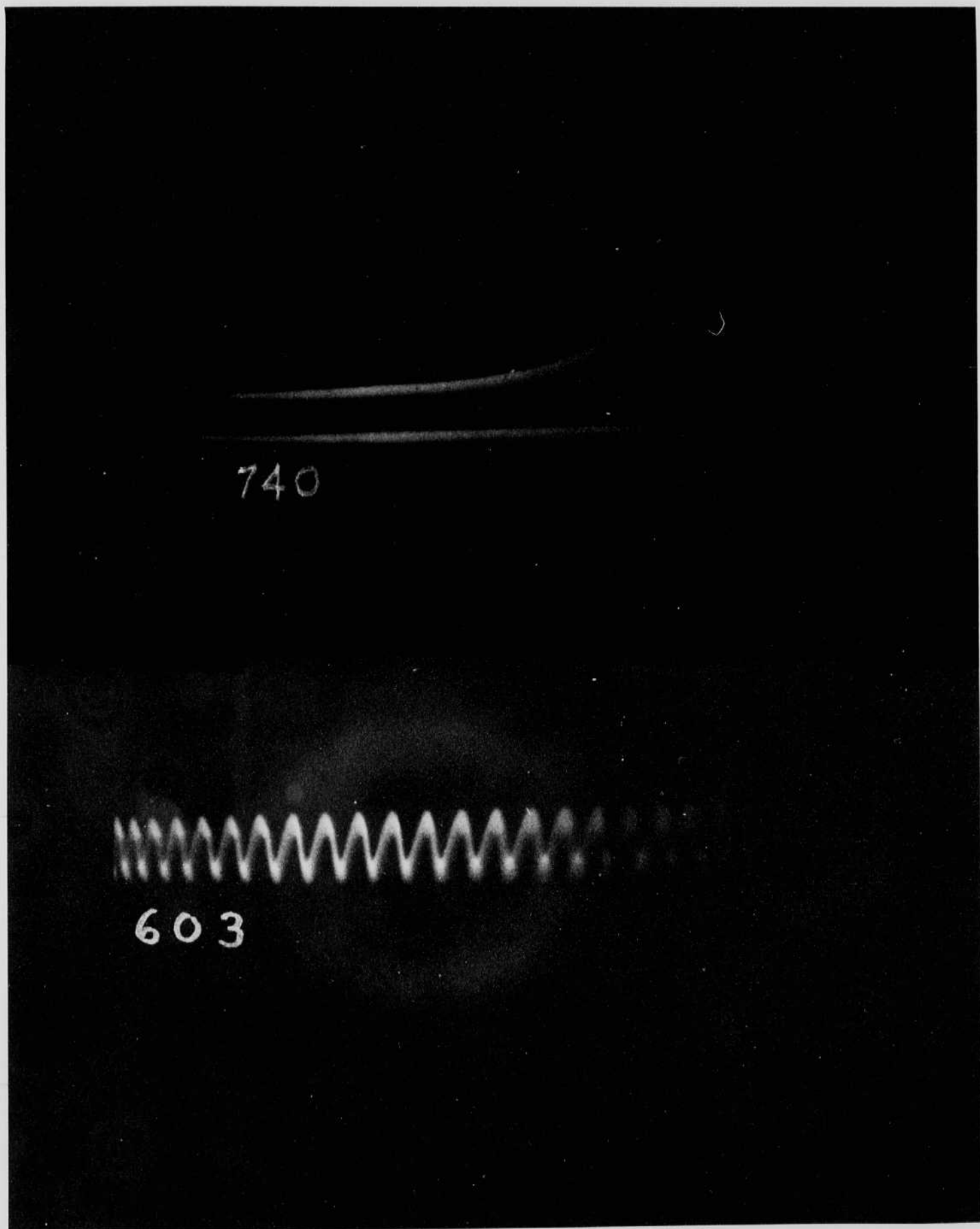

2

931 NAP

NT



Cell current in 4 amp.

0 20 40 60 80 100 120 140 160 ...

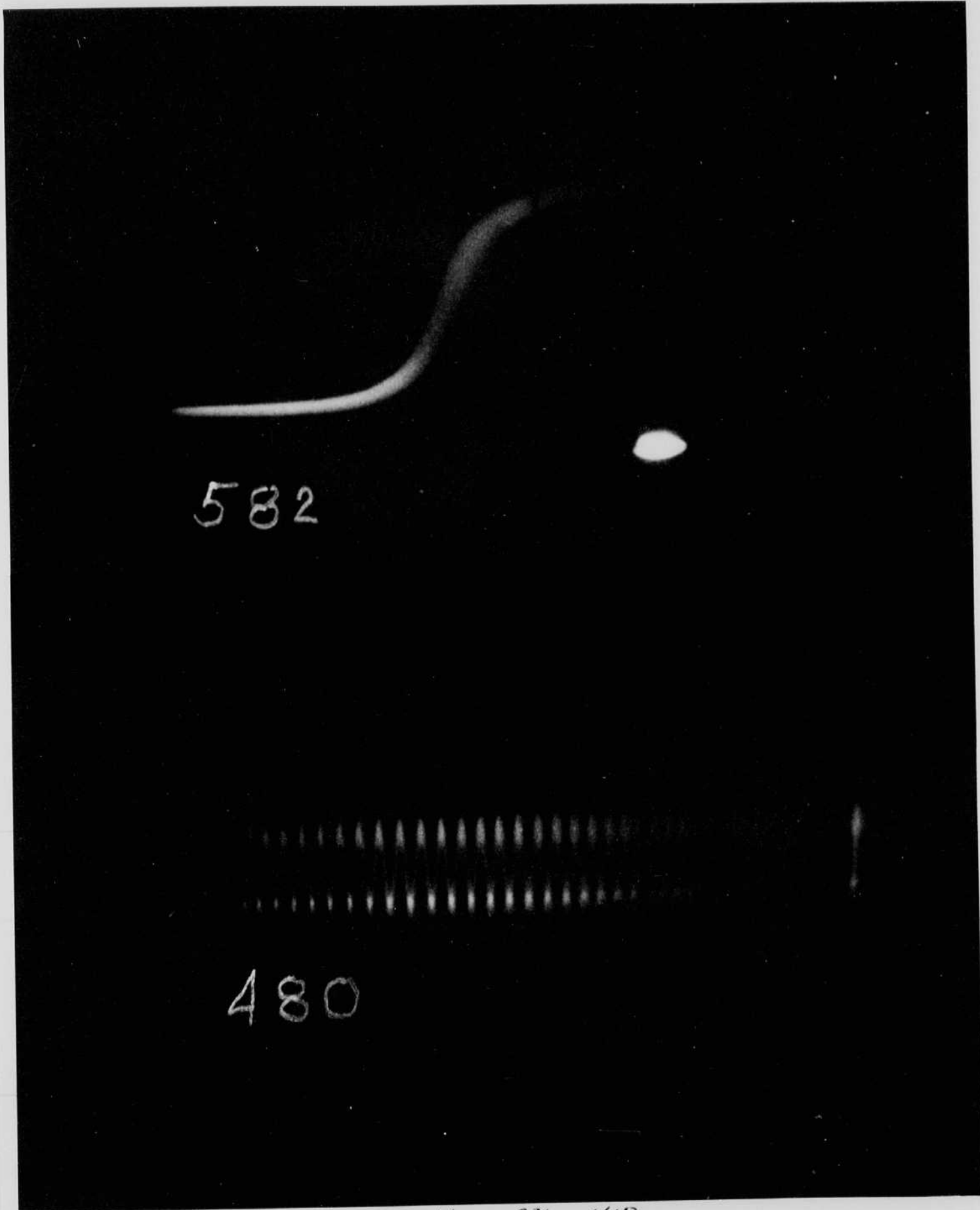

582

480

Y 931 NAP

97

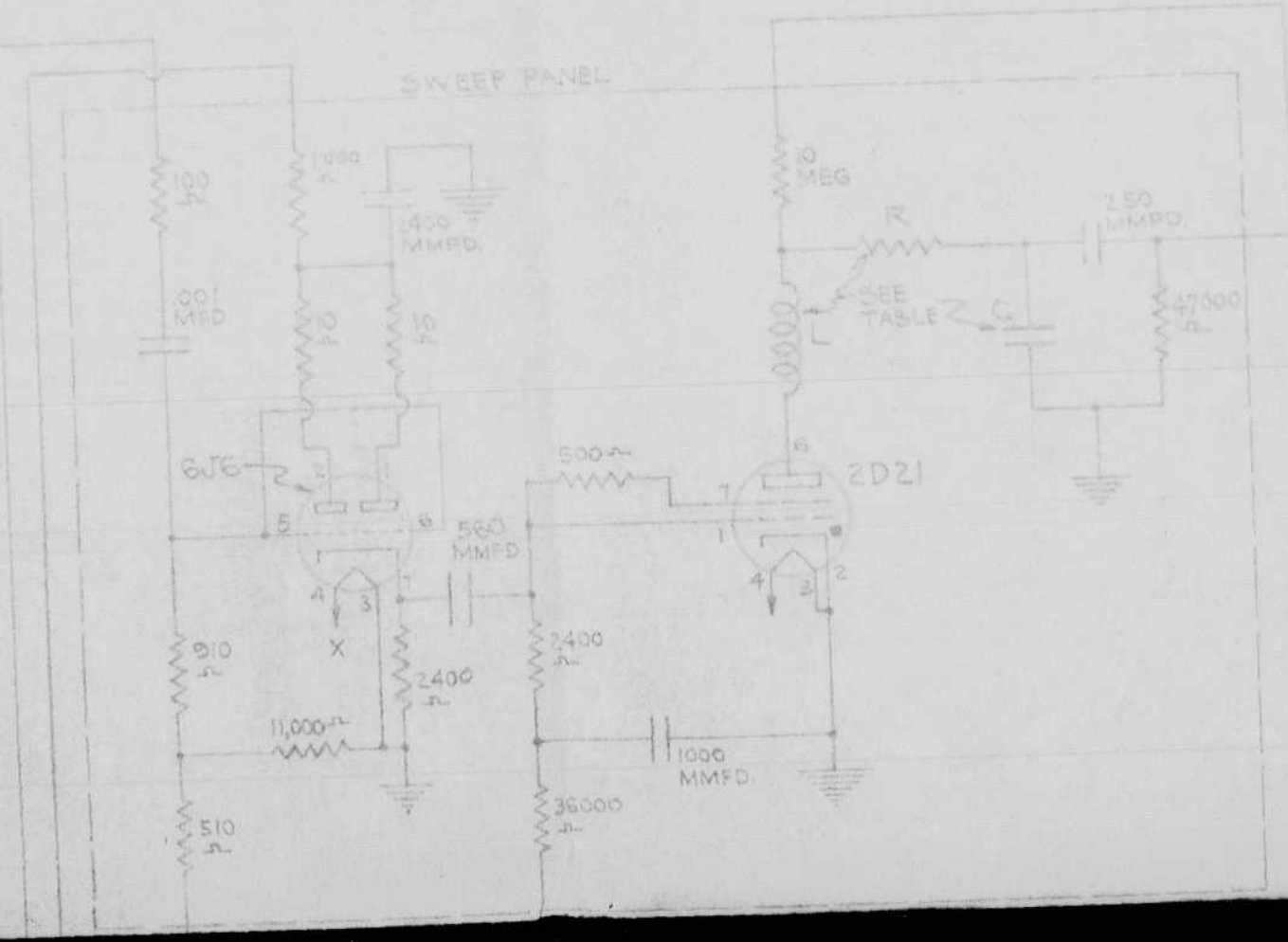
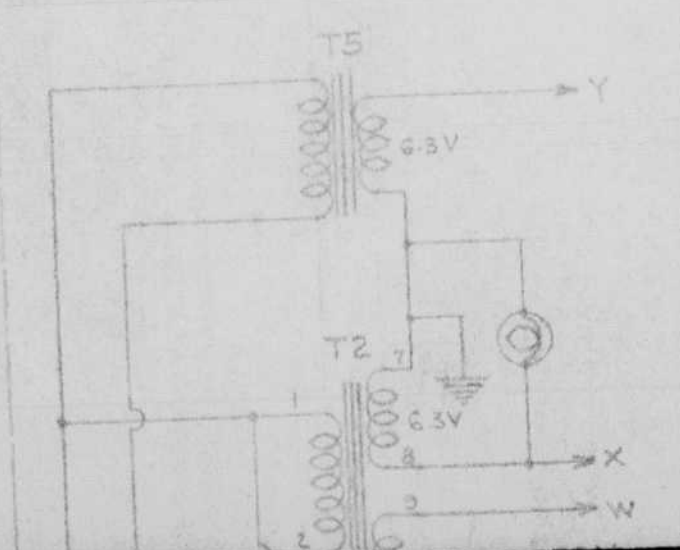
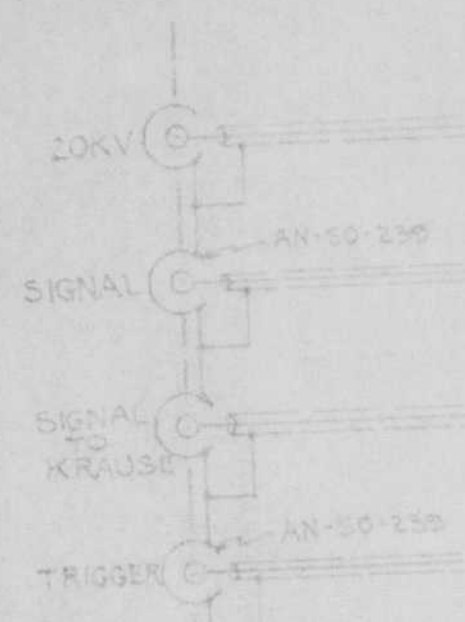

20V/0.5A
 250V/0.5A
 250V/0.5A
 250V/0.5A
 250V/0.5A

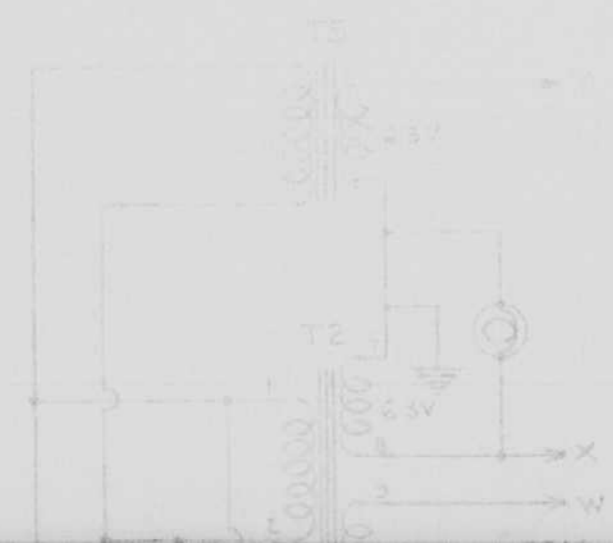

INTENSITY

POINTS A-B-C-D ON SOME SCOPES.

21 KV.

SHOT	X-RAY			YOKE			ZEBRA		
	R	L	C	R	L	C	R	L	C
SCOPE 113 ENGBI-RUNIT	134	46T	700	-	-	-	91	46T	500
SCOPE 105 PARRY	130	46T	700	130	46T	700	130	46T	700
SCOPE 106 PARRY	130	46T	700	130	46T	700	130	46T	700
SCOPE 111	130	46T	700	-	-	-	91	46T	500
SCOPE 122	-	-	-	130	46T	700	130	46T	1300
SCOPE 119	-	-	-	130	46T	800	-	-	-
SCOPE 121	-	-	-	130	46T	700	-	-	-

NOTE - TABLE ABOVE -

1. VALUE OF R GIVEN IN OHMS.
2. VALUE OF L GIVEN IN TURNS # 24 WIRE CLOSE WOUND ON 3/8" DIA. BAKELITE ROD.
3. VALUE OF C GIVEN IN MICRO-MICROFARADS

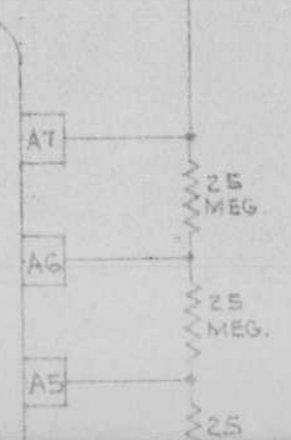

X-RAY

COMPONENT	X-RAY			YOKE			ZEBRA		
	R	L	C	R	L	C	R	L	C
SCOPE 115 ENGINEERING	134	46T	700	-	-	-	91	46T	500
SCOPE 108 PARRY	50	46T	700	130	46T	700	130	46T	700
SCOPE 109 PARRY	50	46T	700	130	46T	700	130	46T	700
SCOPE 111	30	46T	700	-	-	-	91	46T	500
SCOPE 122	-	-	-	130	46T	700	130	46T	1300
SCOPE 124	-	-	-	130	46T	500	-	-	-
SCOPE 127	-	-	-	30	46T	700	-	-	-

NOTE: TABLE ABOVE:-

1. VALUE OF R GIVEN IN OHMS.
2. VALUE OF L GIVEN IN TURNS #24 WIRE CLOSE-WOUND ON 3/8" DIA. BAKELITE ROD.
3. VALUE OF C GIVEN IN MICRO-MICROFARADS



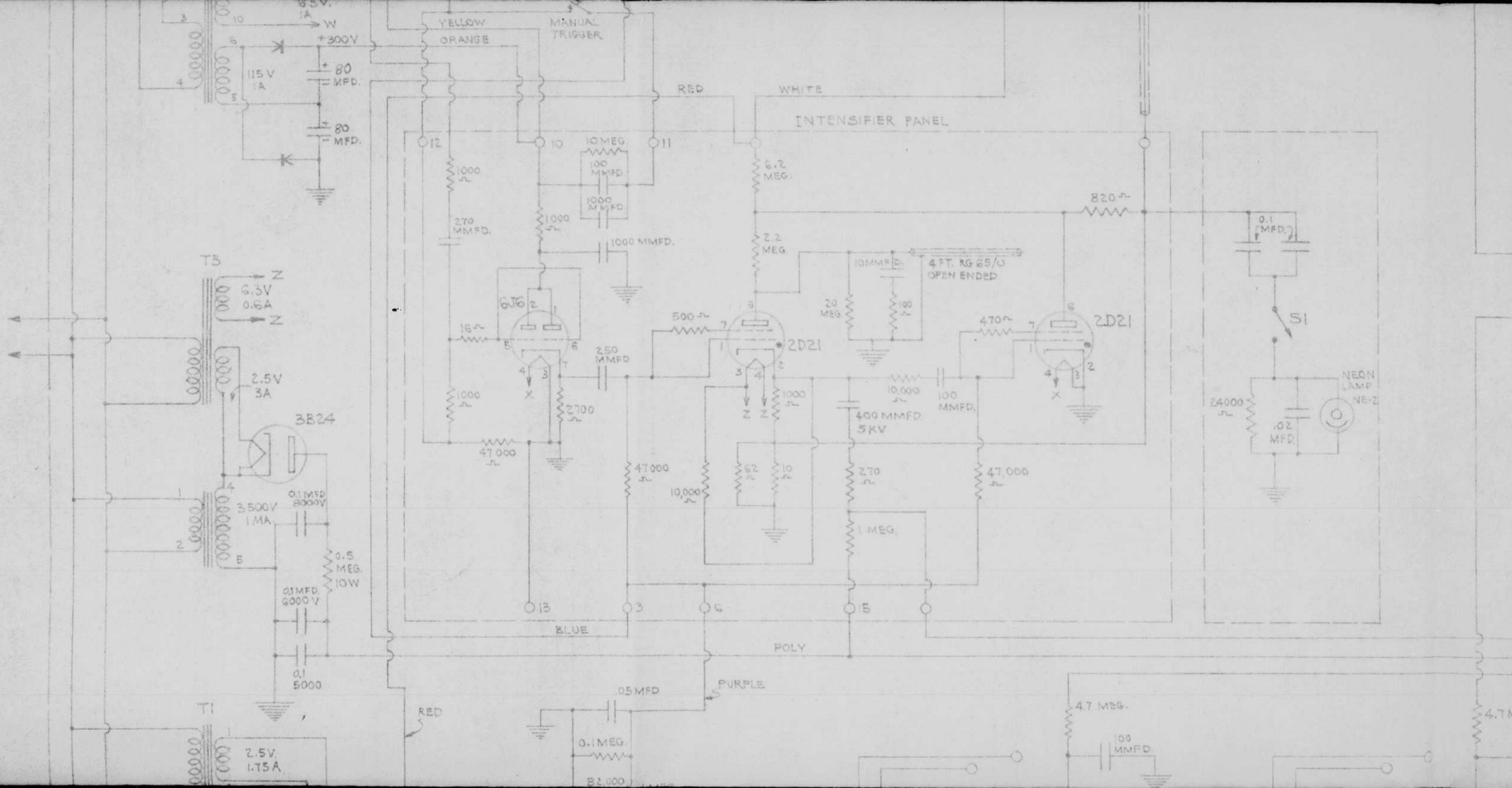

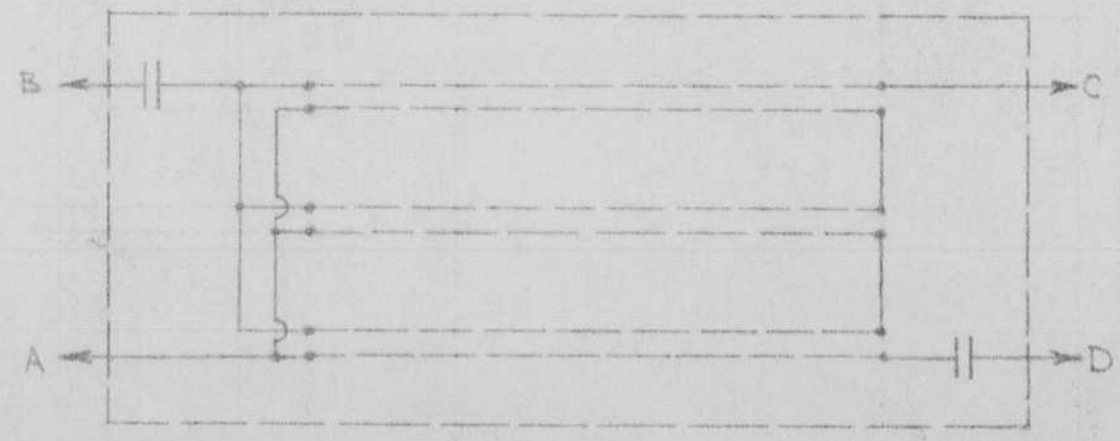
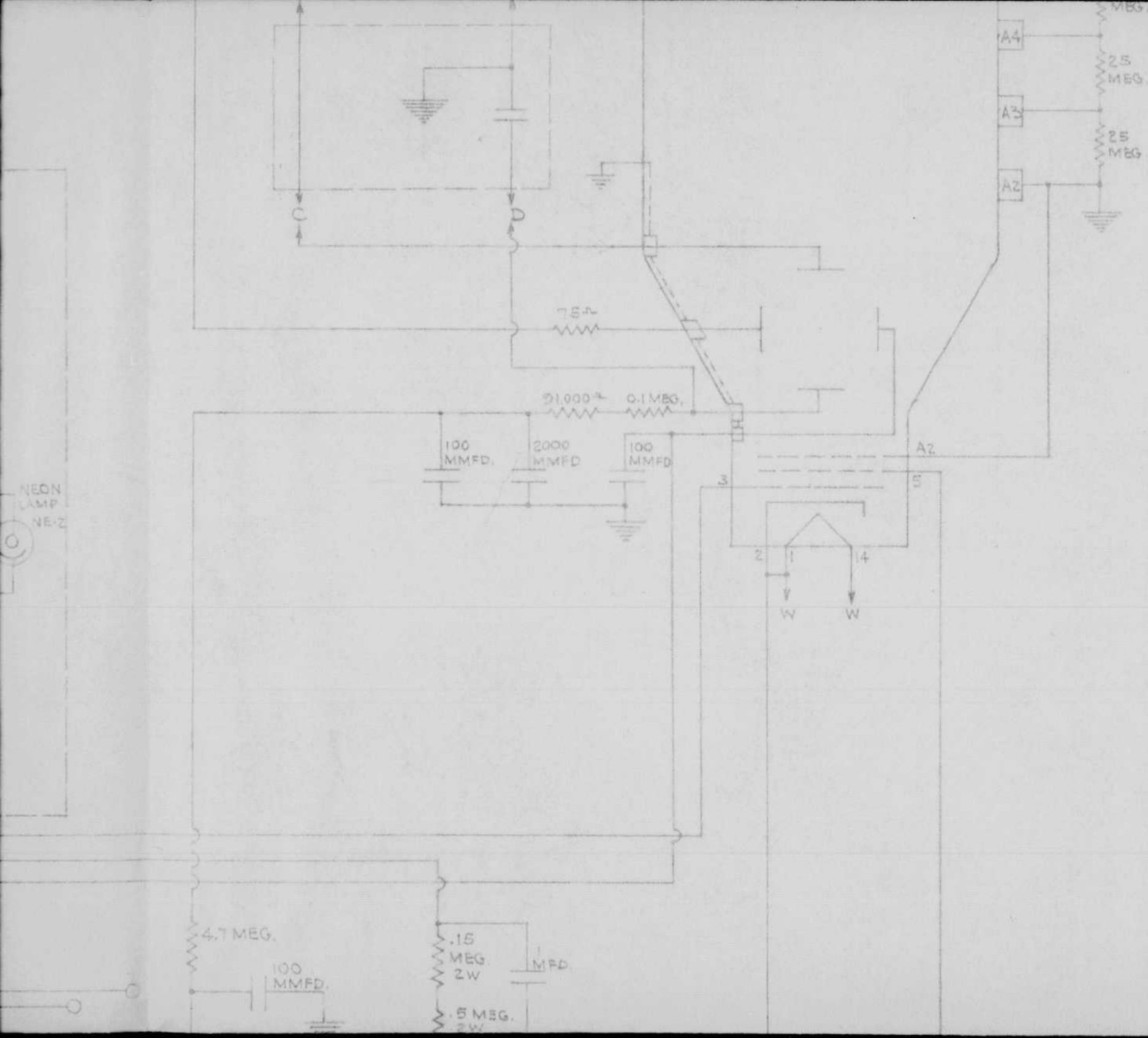

NOTE -
1. PULSE TRANS. SHOWN ABOVE SUBSTITUTED AT

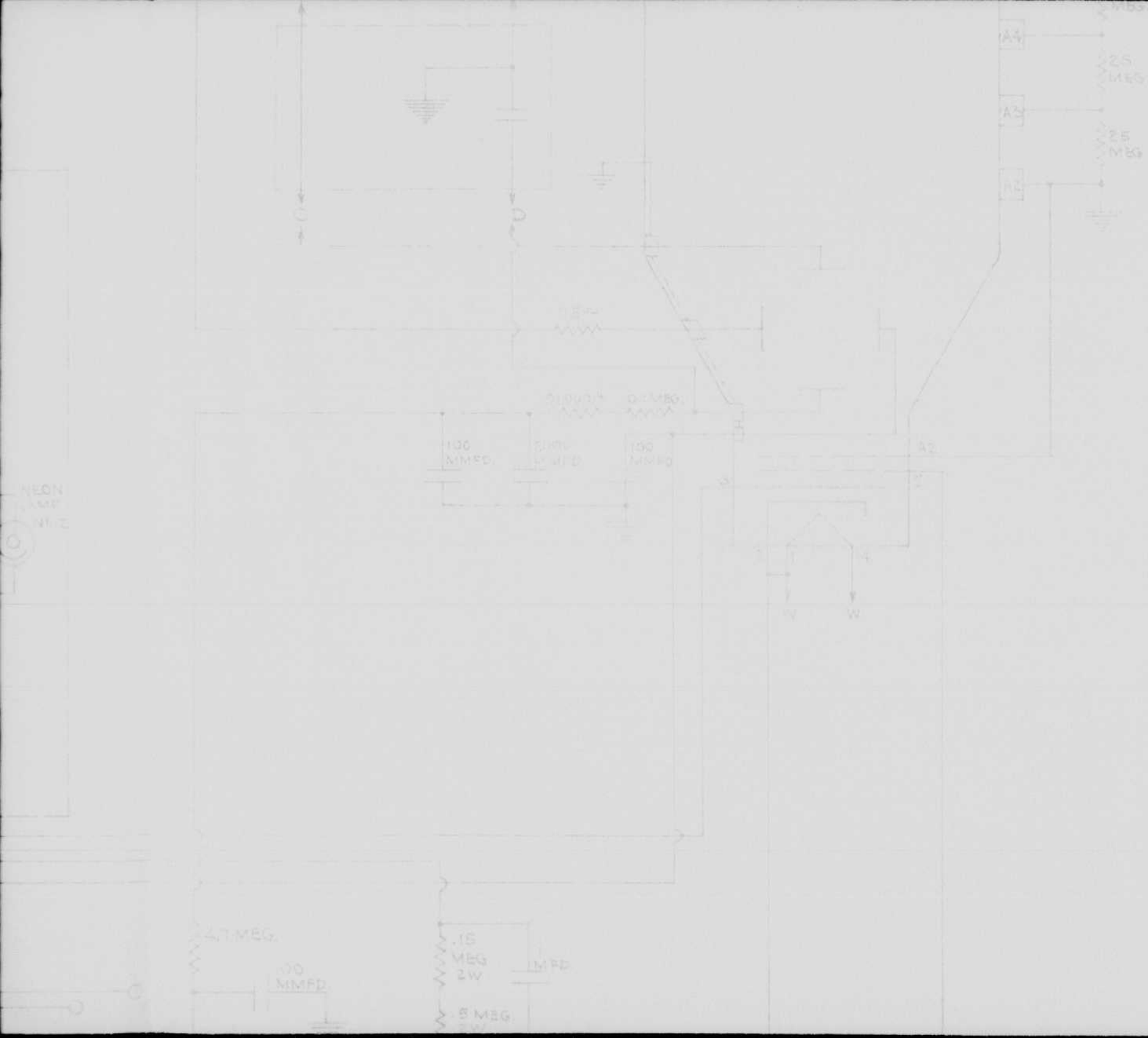

NOTE -
PULSE TRANS SHOWN ABOVE SUBSTITUTED AT

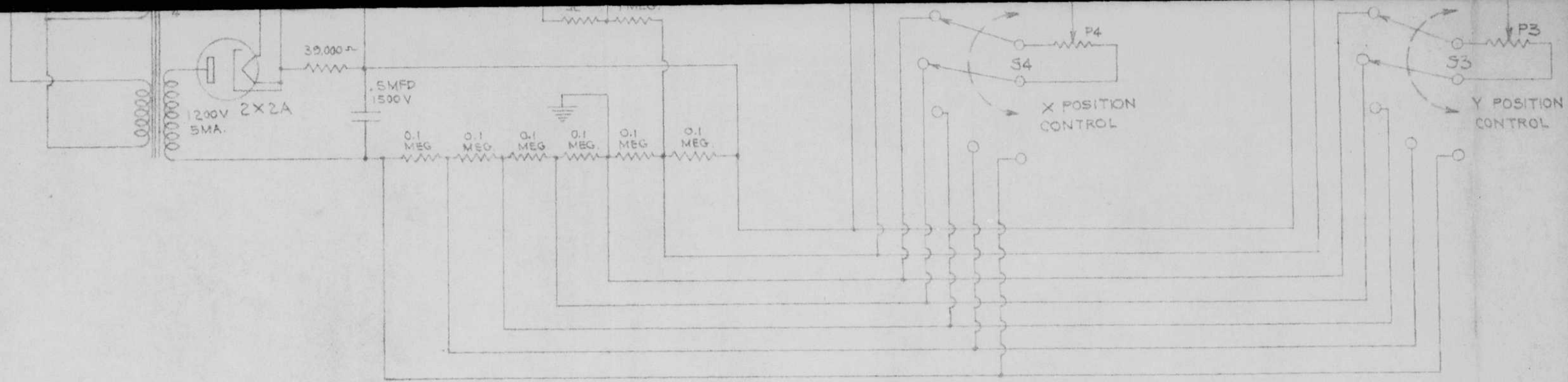

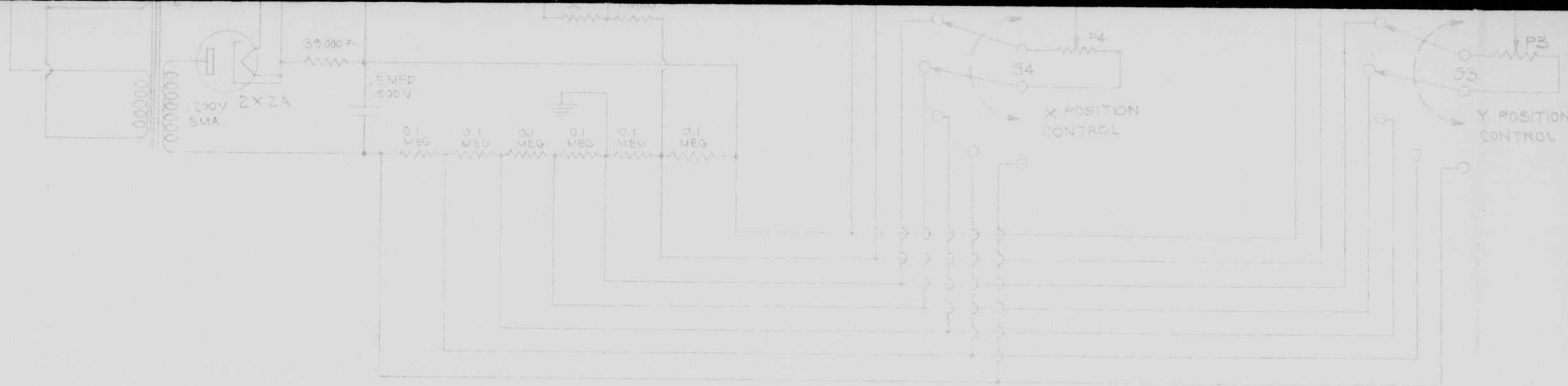

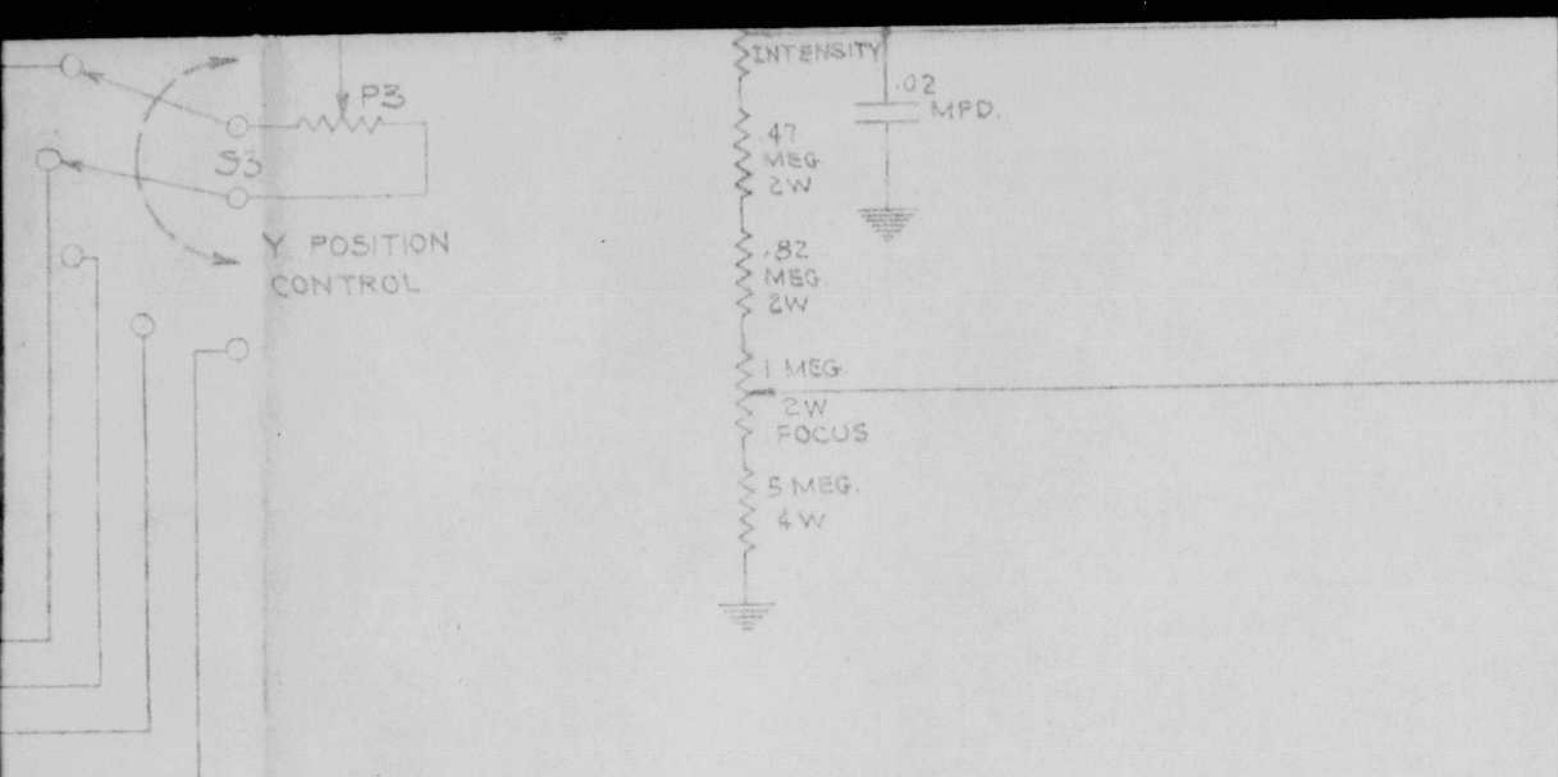

POINTS A-B-C-D ON SOME SCOPES.

REV. LETTER	CHANGED ITEM WAS	DATE	CH'G'D BY	CH'K'D BY	
REVISIONS					
EDGERTON GERMESHAUSEN & GRIER, Inc. CAMBRIDGE, MASSACHUSETTS					
FRACTIONAL	TOLERANCE DECIMAL		ANGULAR		TITLE
	SIGNATURE	DATE	GROUP REPRESENT.	DATE	CATHODE RAY INDICATOR
ORIGINATED					
DRAWN	DALLER	7-9-48			
CHECKED					
PROJ. ENG.			SCALE	CLIENTS #	DWG. #
APPROVED					3102DIOF
PART NO.					

July 12 1948 #258y.

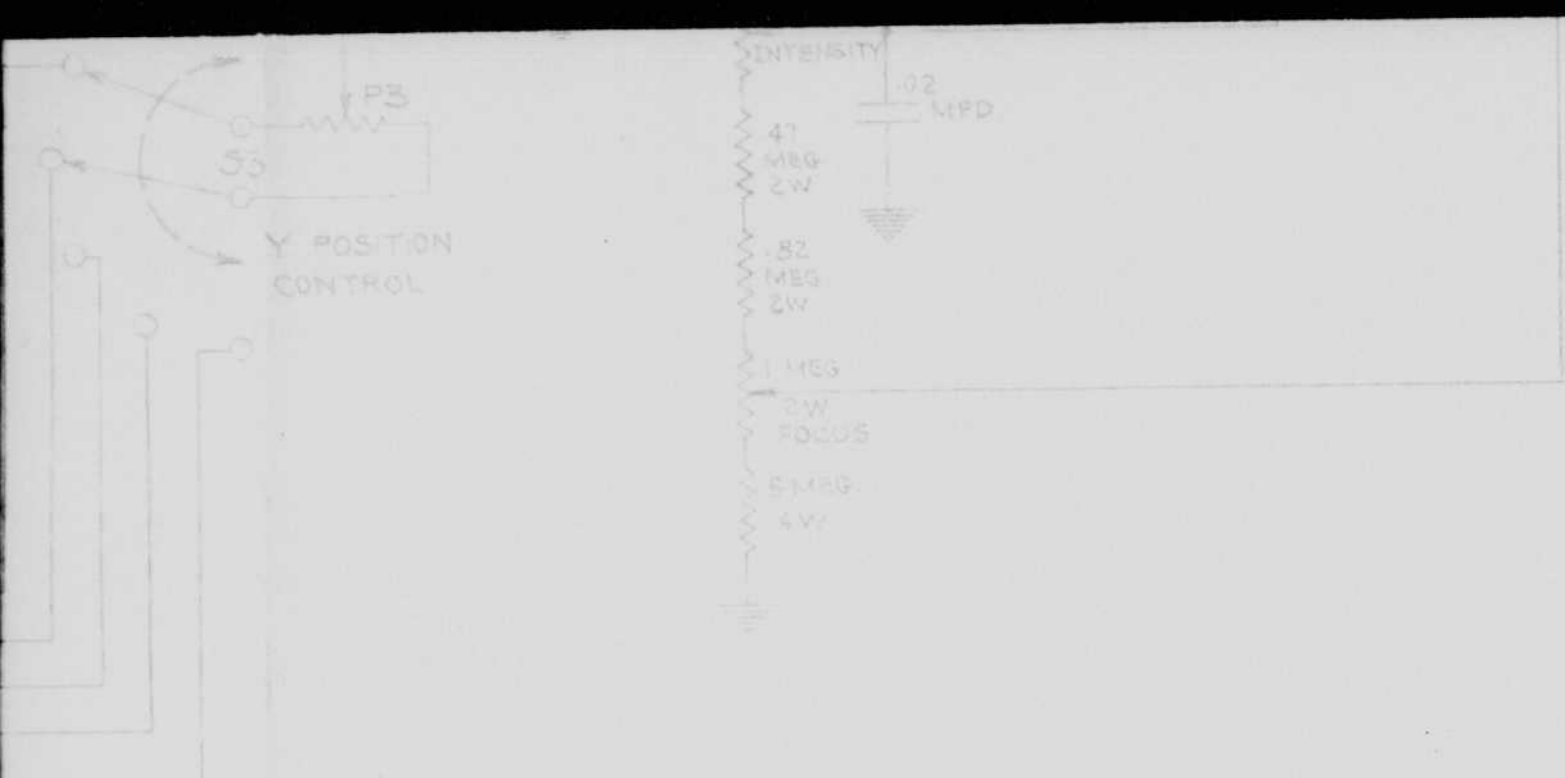

POINTS A-B-C-D ON SOME SCOPES.

REV. LETTER	CHANGED ITEM WAS	DATE	CH'G'D BY	CHK'D BY	
REVISIONS					
EDGERTON GERMESHAUSEN & GRIER, Inc.					
CAMBRIDGE, MASSACHUSETTS					
FRACTIONAL	TOLERANCE DECIMAL		ANGULAR		TITLE
	SIGNATURE	DATE	GROUP REPRESENT.	DATE	CATHODE RAY INDICATOR
ORIGINATED					
DRAWN	DALLER	7-9-48			
CHECKED					
PROJ. ENG.			SCALE	CLIENTS #	DWG. #
APPROVED					3102DIOF
PART NO.					

July 12 1948 #958.

POINTS A-B-C-D ON SOME SCOPES.

SHOT COMPONENT	X-RAY			YOKE			ZEBRA		
	R	L	C	R	L	C	R	L	C
SCOPE 113 ENGBI-RUNIT	134	46T	700	-	-	-	91	46T	500
SCOPE 105 PARRY	130	46T	700	130	46T	700	130	46T	700
SCOPE 108 PARRY	130	46T	700	130	46T	700	130	46T	700
SCOPE 111	130	46T	700	-	-	-	91	46T	500
SCOPE 122	-	-	-	130	46T	700	130	46T	1300
SCOPE 119	-	-	-	130	46T	800	-	-	-
SCOPE 121	-	-	-	130	46T	700	-	-	-

NOTE - TABLE ABOVE -

1. VALUE OF R GIVEN IN OHMS.
2. VALUE OF L GIVEN IN TURNS #24 WIRE CLOSE-WOUND ON $\frac{3}{8}$ " DIA. BAKELITE ROD.
3. VALUE OF C GIVEN IN MICRO-MICROFARADS

Time	Volts	ya	Time	Volts	ya
0515	700	3	0630	800	2
	1000	22		1000	7
	1200	74		1200	22
	1300	140		1300	46
0530	700	2		1400	84
	1000	22		1500	145
	1200	72	0635	700	2
	1300	130		1000	20
0545	700	2		1100	40
	1000	14		1200	76
	1200	24		1300	140
	1300	78	0640	700	6
	1400	130		900	35
	1500	200		1000	74
0600	700	2		1100	190
	800	4	0645	700	14
	1000	9		800	4.3
	1200	25	61?	900	10.6
	1300	45	0640	700	50
	1400	70		800	150
	1500	110	0643	800	200
	1600	155	0645	700	200
0615	800	2	0659	600	200
	1000	5	0703	500	200
	1200	15			
1300	1400	29			
	1500	64			
	1600	92			
	1800	180			

POINTS A-B-C-D ON SOME SCOPES.

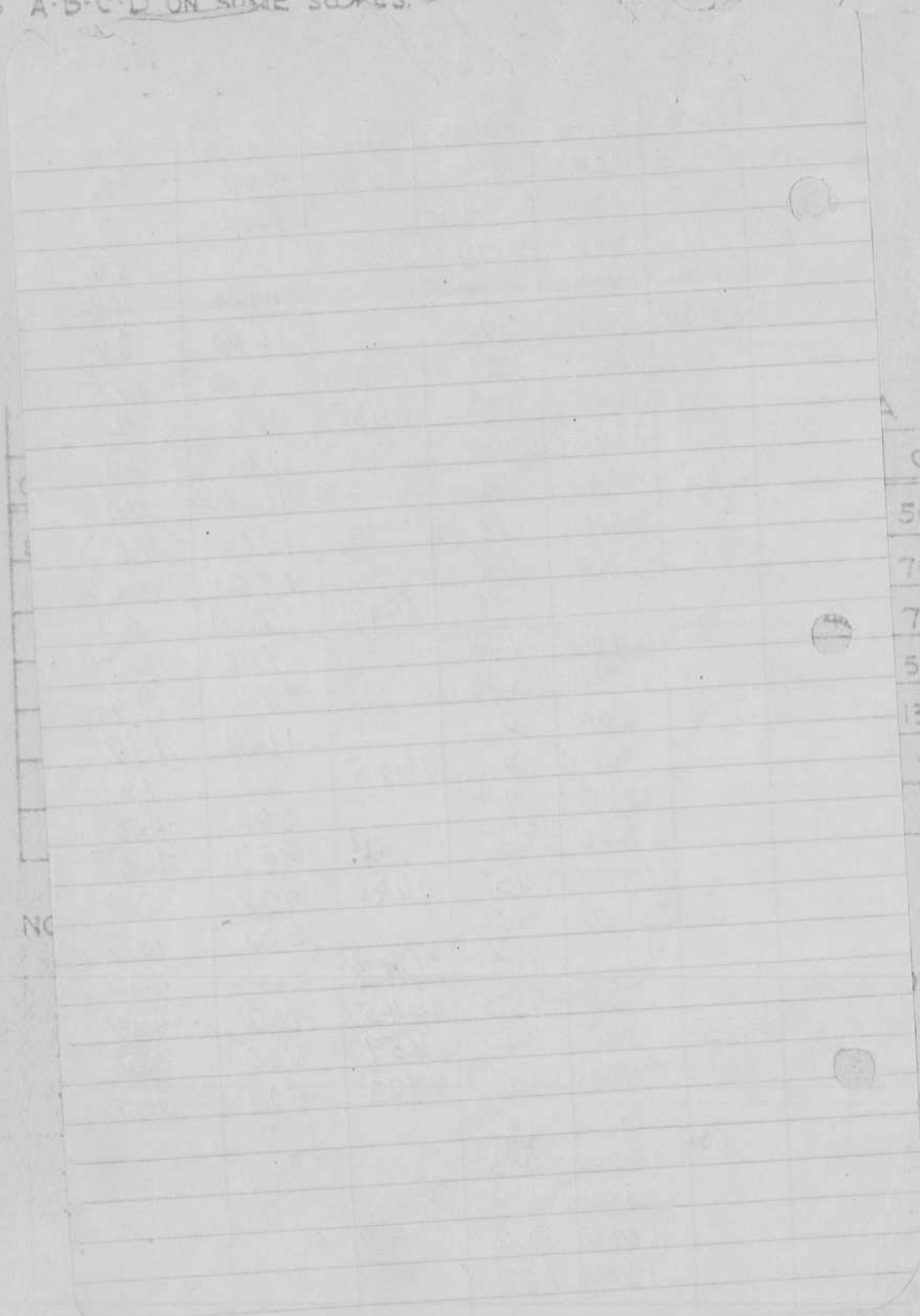

A
C
500
700
700
500
1300
-
-

NO

IND

Moon 30° left of LOS

- 0515 - Scattered horizon clouds
& haze - overhead more -
stricter - moon bright (nearly full)
- 0545 - moon brightness reduced by
haze - slight overcast at horizon
- 0600 - Moon beginning to go down behind
horizon clouds - slight horizon
haze
- 0615 moon totally obscured by
horizon clouds - sky just beginning
to perceptibly lighten towards the east
- 0630 - sky perceptibly lightening in
west - heavy overcast coming
up in east

POINTS A-B-C

OFF

[Lined area for notes]

A
C
500
700
700
500
300
-
-

NO

ND

Run #2 - March 25

Anode-cathode voltage - 1300 volts
Night light measurement of Photomultiplier

1200V		1300V	
Time	Current μ a	Time	Current μ a
0500	115	0500	200
0515	95	0515	170
0530	125	0530	>200
0545	125	0545	>200
0600	110	0600	200
0615	70	0615	125
0627	60	0627	115
0630	50	0630	105
0635	95	0635	170
0640	170	0640	>200
0641	200		

POINTS A-B-C

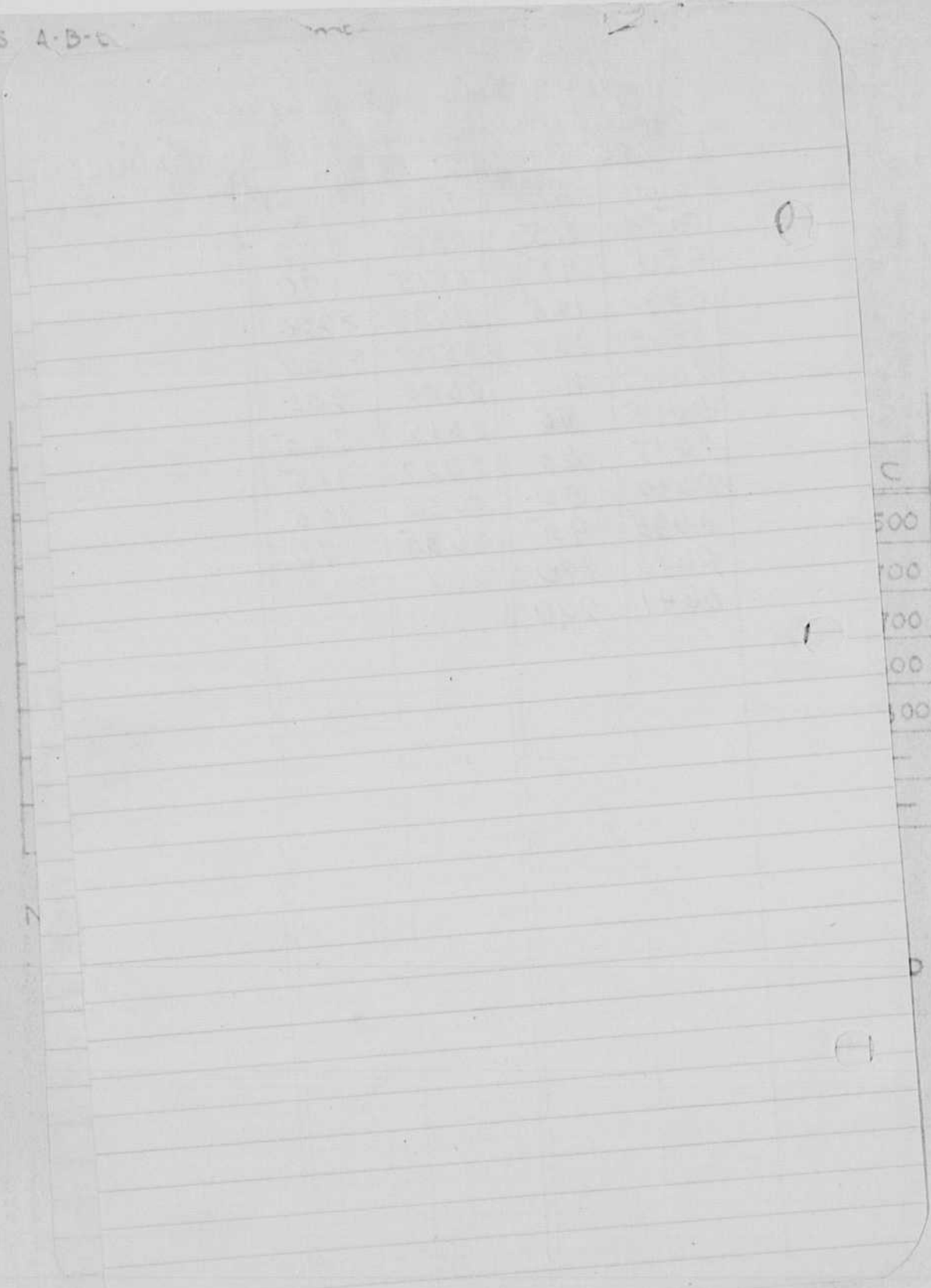

C
500
700
700
00
500

D

- 0500 - scattered clouds 20-30%
moon full - very faint haze
ring around moon
- 0515 - scattered clouds 10% at horizon
overhead unlimited except for
haze - moon 45° left of LOS
- 0530 - Same as 0515
- 0545 - Same as 0530
- 0600 - scattered clouds 20%
- 0615 - clouds 50% up to 20° above
horizon
- 0627 - Taken as comparison before
moon was obscured by large
black cloud
- 0630 - moon behind cloud - sky
otherwise clear - sky begin-
ning to brighten in east

POINTS A

C

00

00

00

00

00

Z

Harry Smith
 N 3 Series

Cell current in μ amp.

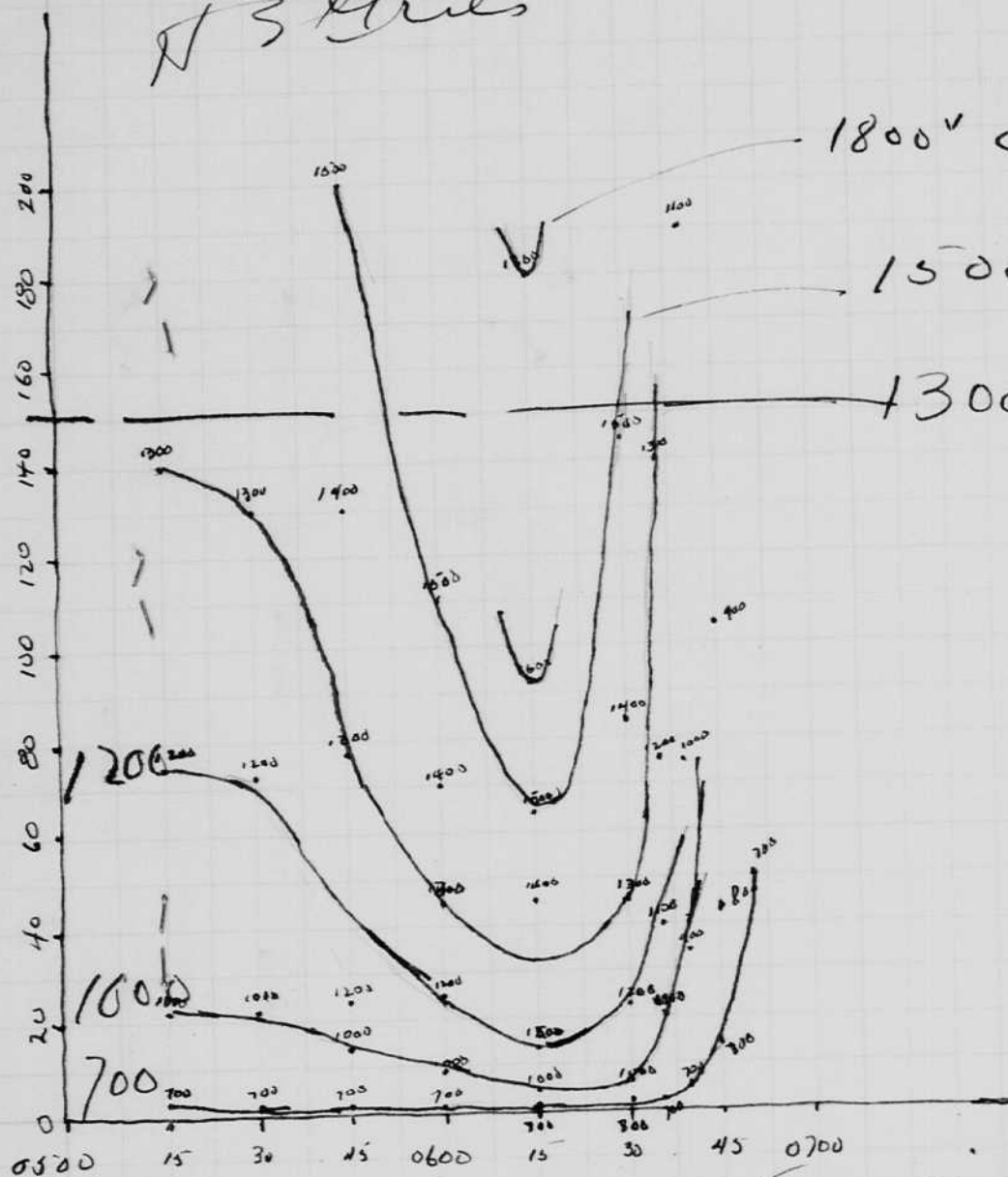

Limit of Voltage on
 this cell = 1500^v
 operate at 1300
 \therefore We could operate
 up to 06.30

Moonlight

Sunrise

Time

Photocell current from night sky

Figure 3 -

3-2 4-48
A3 Grier

Data taken by Harry Smith

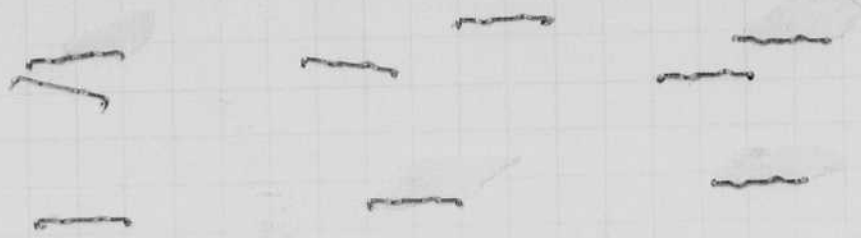

— — —

YA121 583 935 S.L.

EUGENE DIETZEN CO.
MADE IN U.S.A.

NO. 340-1210 DIETZEN GRAPH PAPER
SEMI-LOGARITHMIC
2 CYCLES X 10 DIVISIONS PER INCH

SCOPE DISPLACEMENT - VOLTS

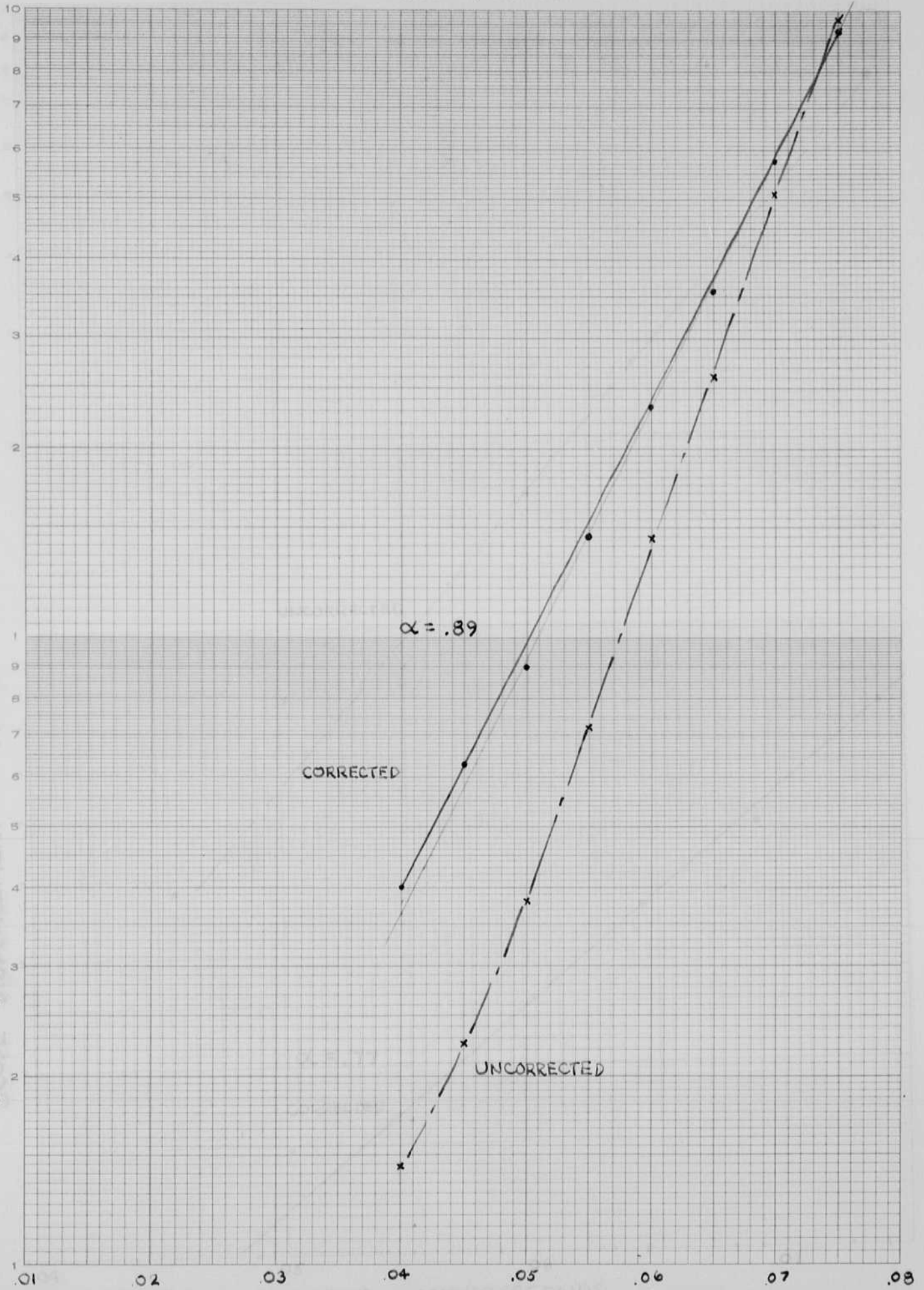

TIME - MICROSECONDS

Y AIRI 289 982 2-4

3

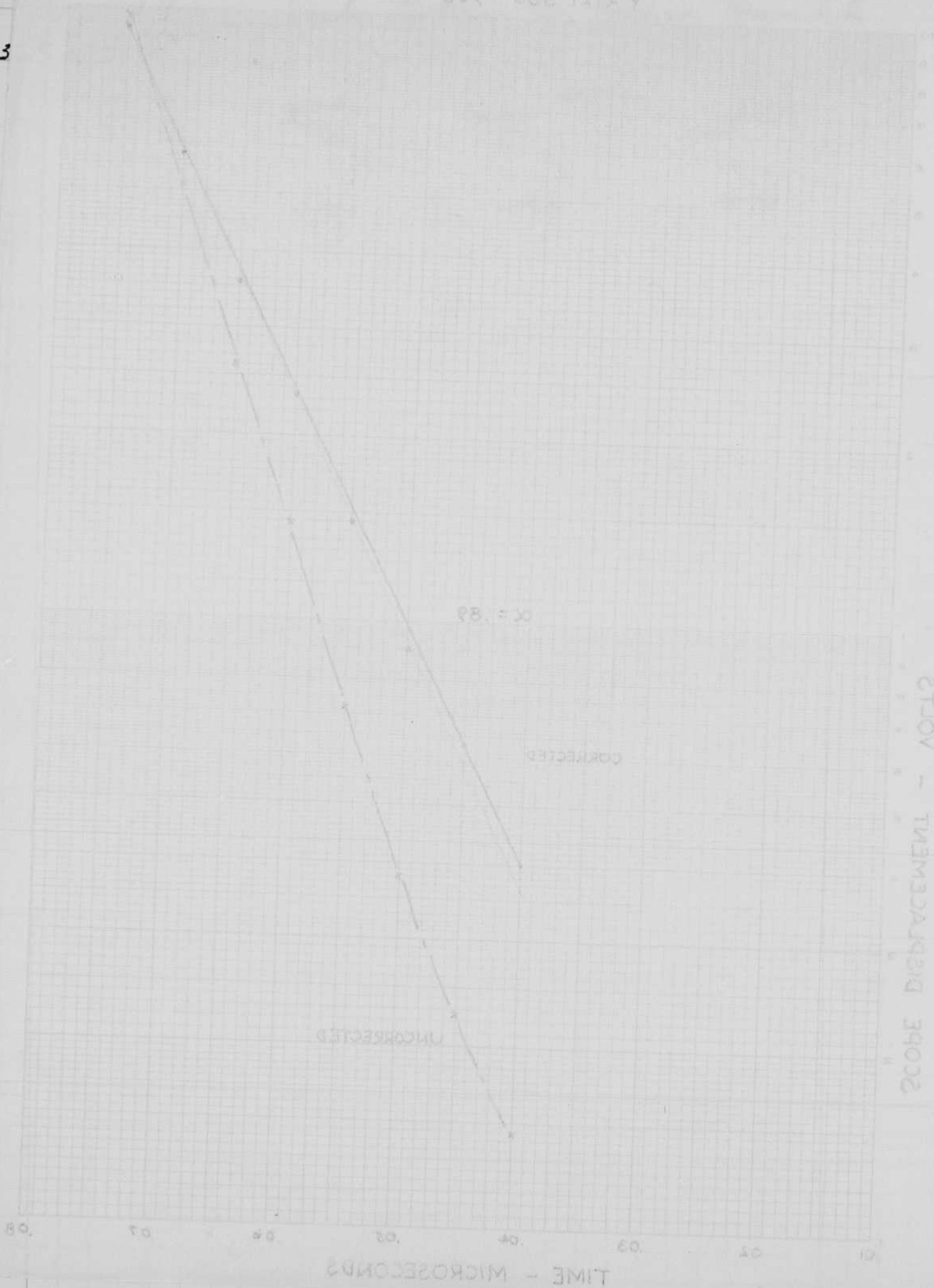

SCOPE DISPLACEMENT - VOLTS

TIME - MICROSECONDS

0.88

CORRECTED

UNCORRECTED

Y 931 NAP

PARRY

EUGENE DIETZGEN CO.
MADE IN U.S.A.

NO. 340-L210 DIETZGEN GRAPH PAPER
SEMI-LOGARITHMIC
2 CYCLES X 10 DIVISIONS PER INCH

SCOPE DISPLACEMENT - VOLTS

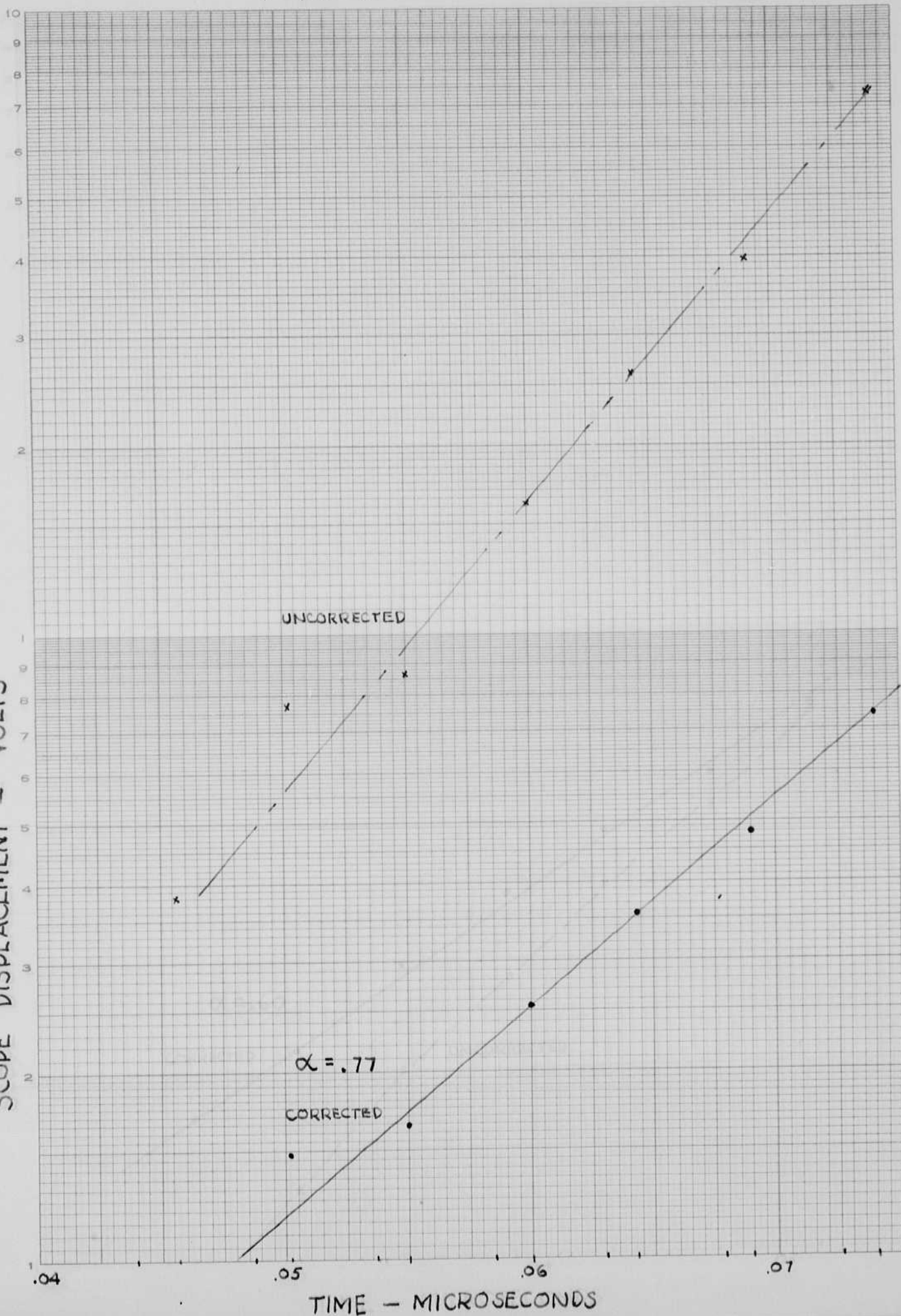

Y 231 MAP

3

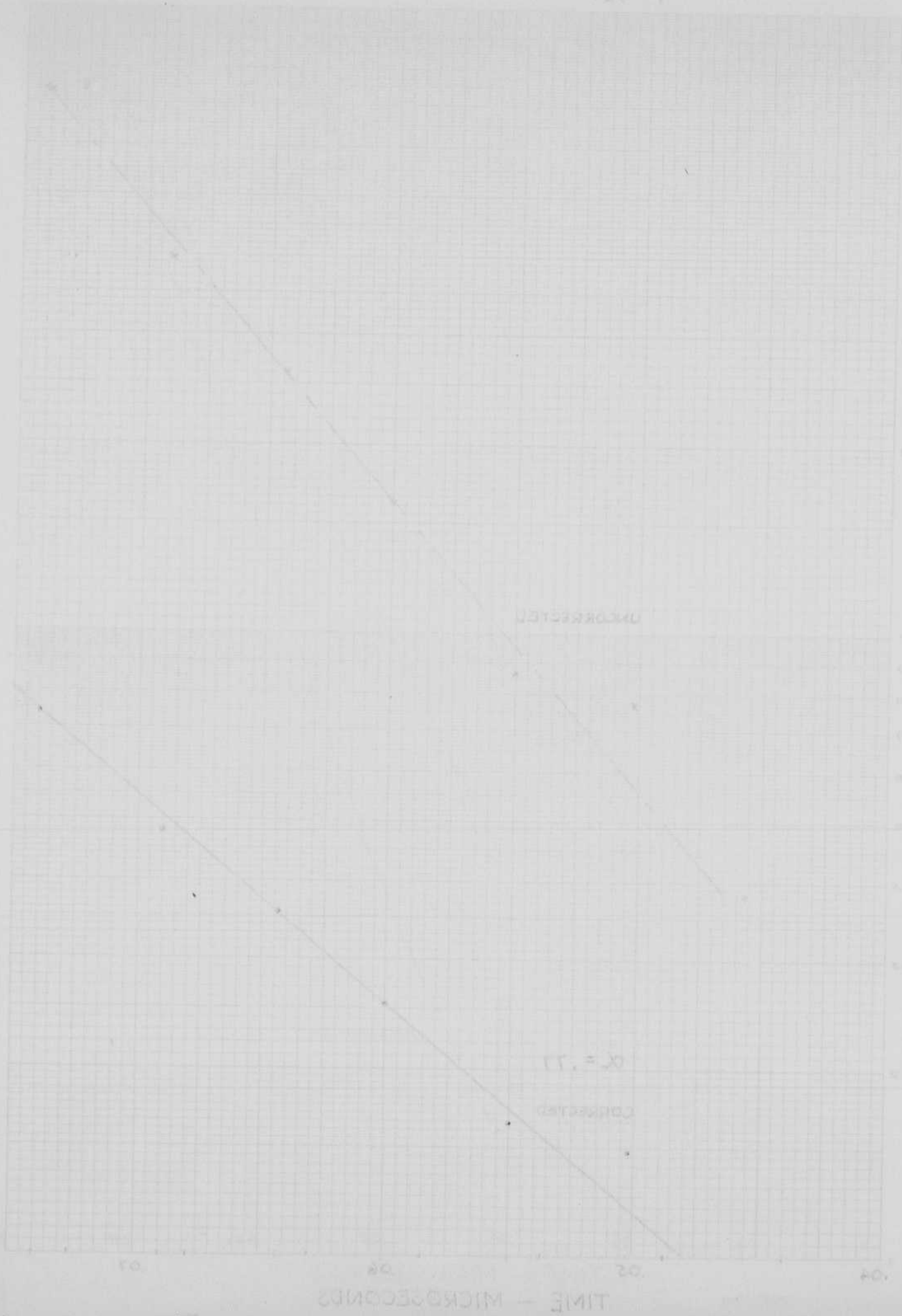

SCOPE DISPLACEMENT - LOG12

$\alpha = 17.1$
CORRECTED

TIME - MICROSECONDS

Y 931 S.L. PARRY

EUGENE DIETZGEN CO.
MADE IN U.S.A.

NO. 340-L210 DIETZGEN GRAPH PAPER
SEMI-LOGARITHMIC
2 CYCLES X 10 DIVISIONS PER INCH

SCOPE DISPLACEMENT - VOLTS

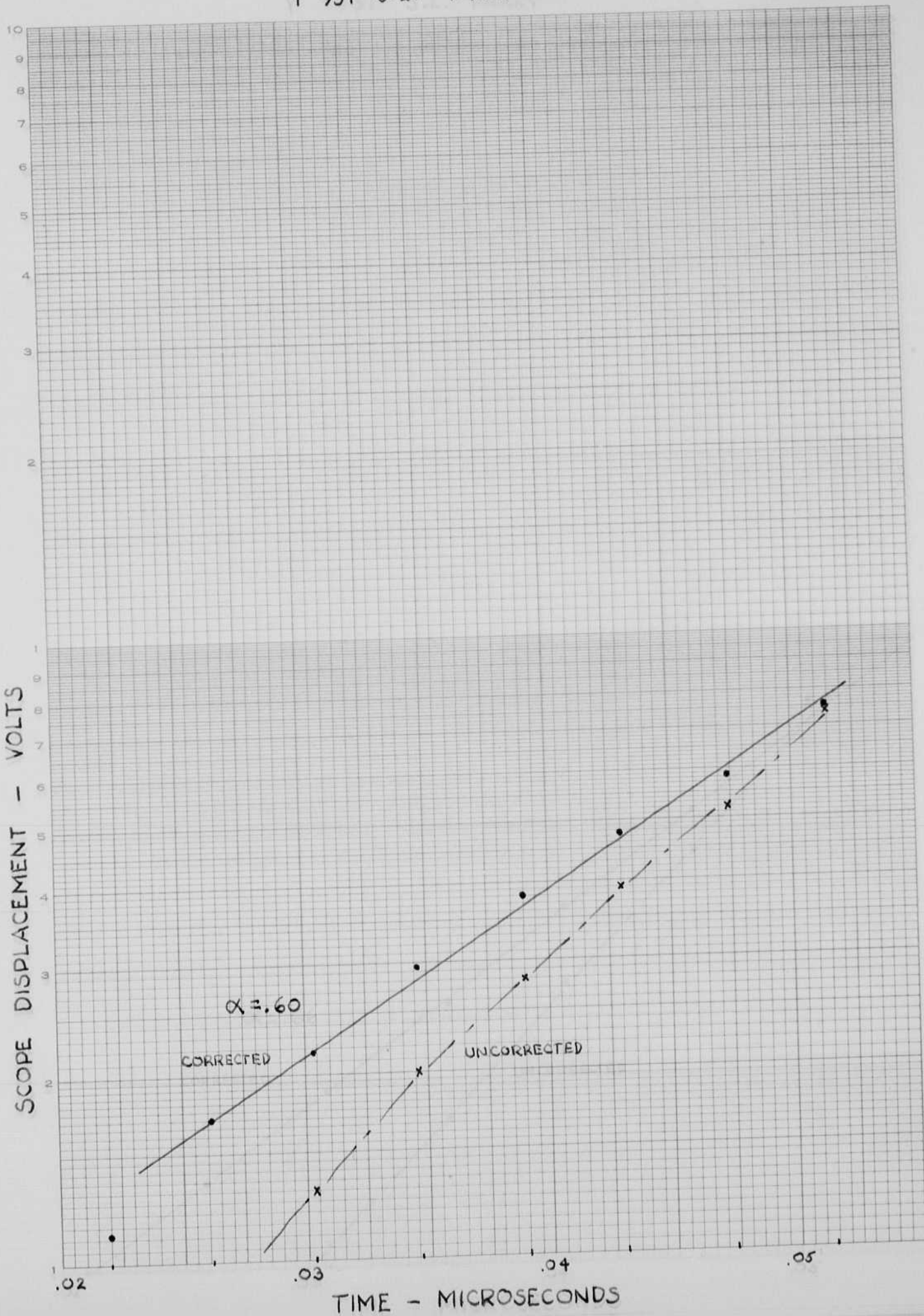

TIME - MICROSECONDS

Y 931 6 L. PARKY

3

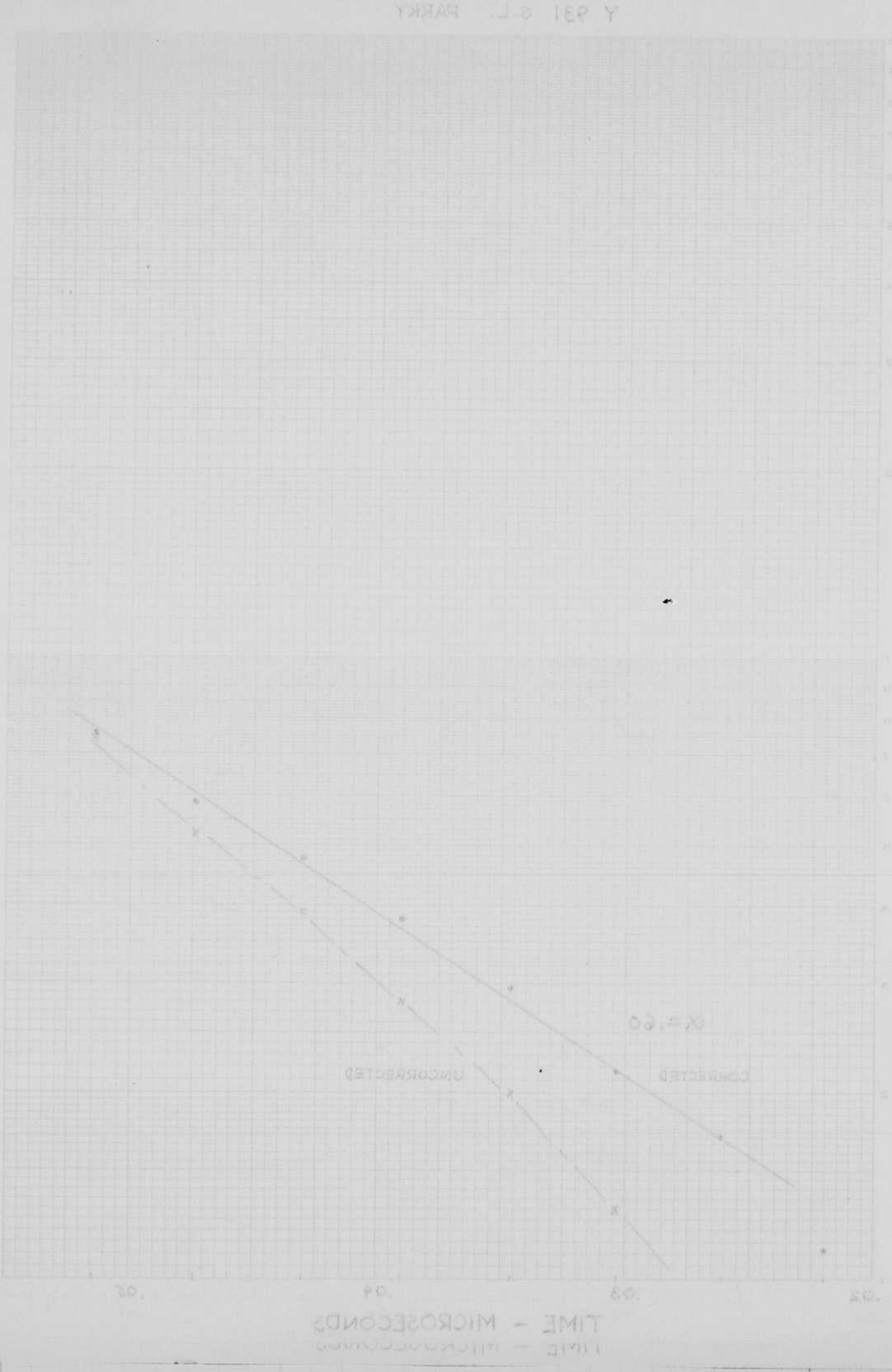

SCOPE DISPLACEMENT - VOLTS

TIME - MICROSECONDS

K=1.60

UNCORRECTED

CORRECTED

PHOTO COPY

PHOTO COPY

Y 931 S.L. PARRY

EUGENE DIETZGEN CO.
MADE IN U.S.A.

NO. 340-L210 DIETZGEN GRAPH PAPER
SEMI-LOGARITHMIC
2 CYCLES X 10 DIVISIONS PER INCH

SCOPE DISPLACEMENT - VOLTS

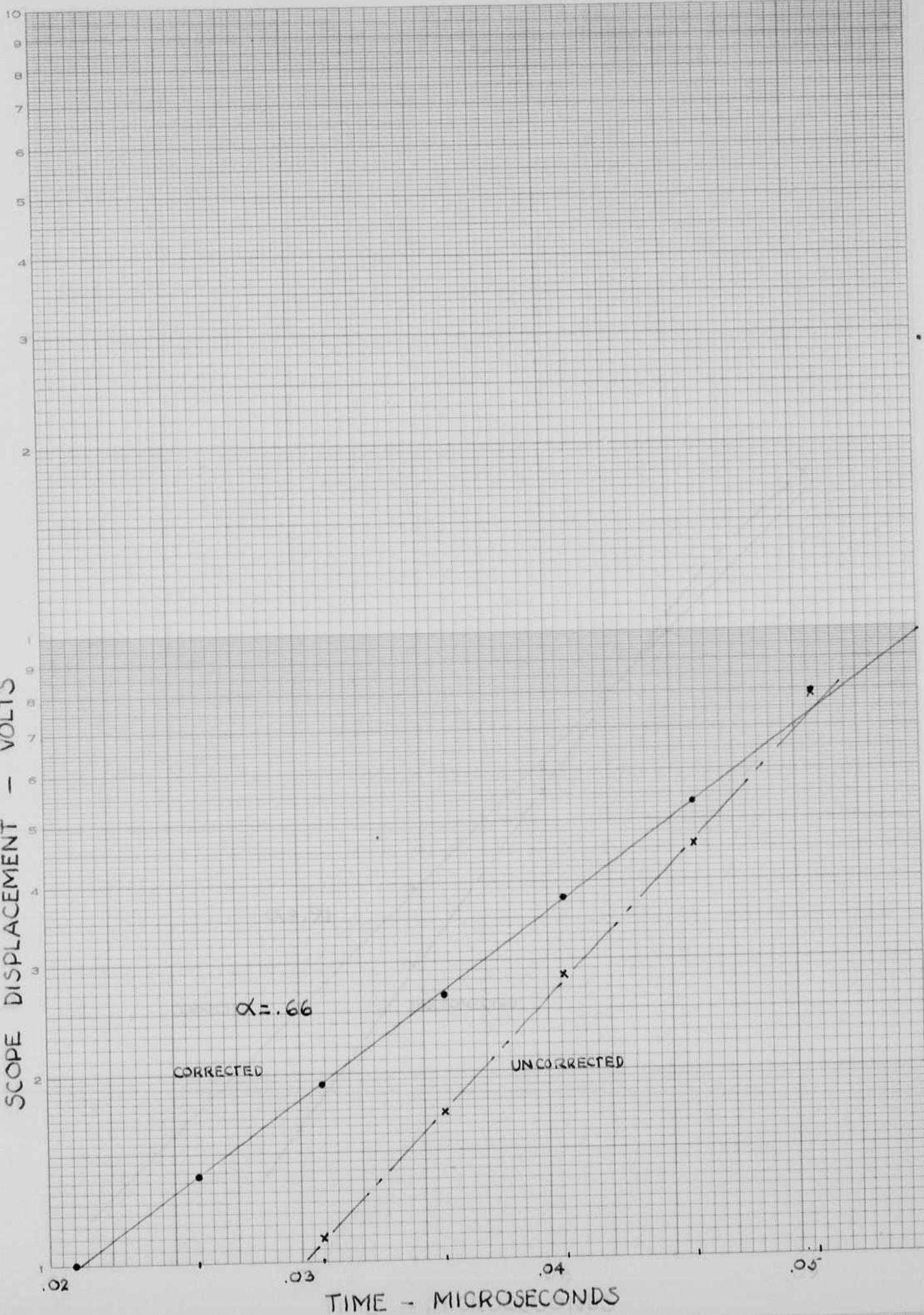

Y 931 2-L PARRY

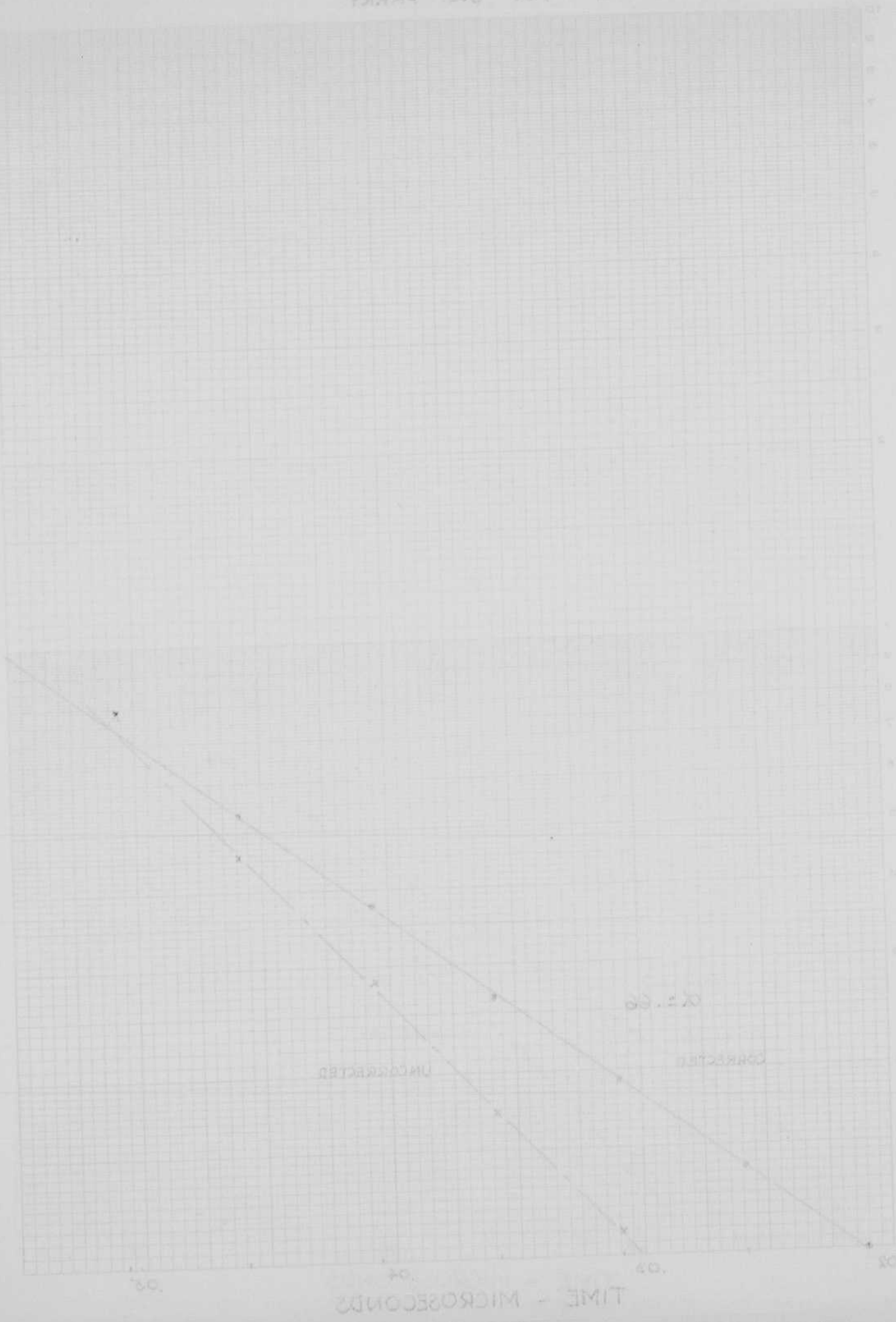

SCOPE DISPLACEMENT - LOG12

TIME - MICROSECONDS

0.150

UNCORRECTED

CORRECTED

0.8

0.4

0.2

0.0

12

8

4

0

X 931 S.L. PARRY

EUGENE DIETZGEN CO.
MADE IN U.S.A.

NO. 340-L210 DIETZGEN GRAPH PAPER
SEMI-LOGARITHMIC
2 CYCLES X 10 DIVISIONS PER INCH

SCOPE DISPLACEMENT - VOLTS

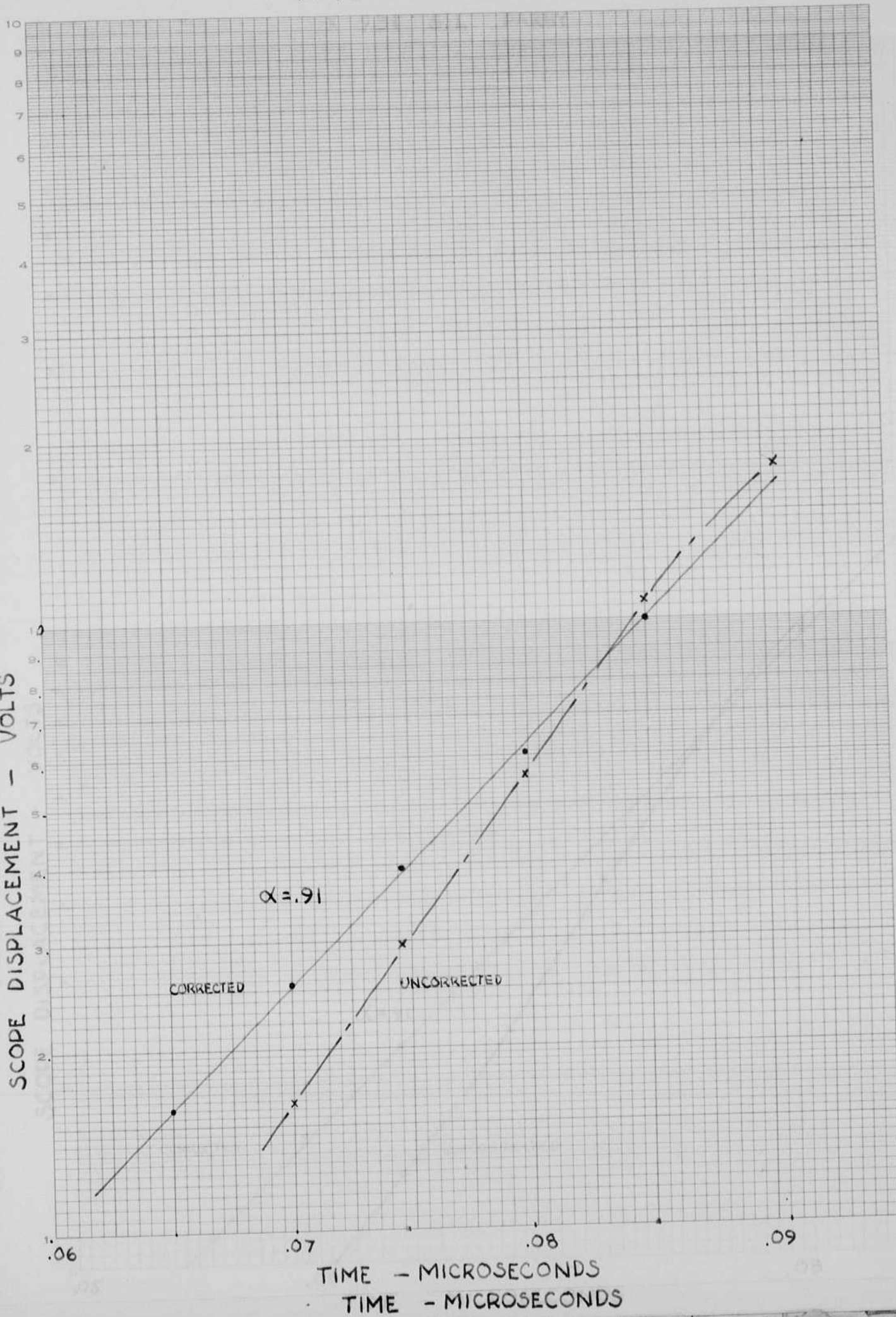

TIME - MICROSECONDS
TIME - MICROSECONDS

X 231 2.T. PARKY

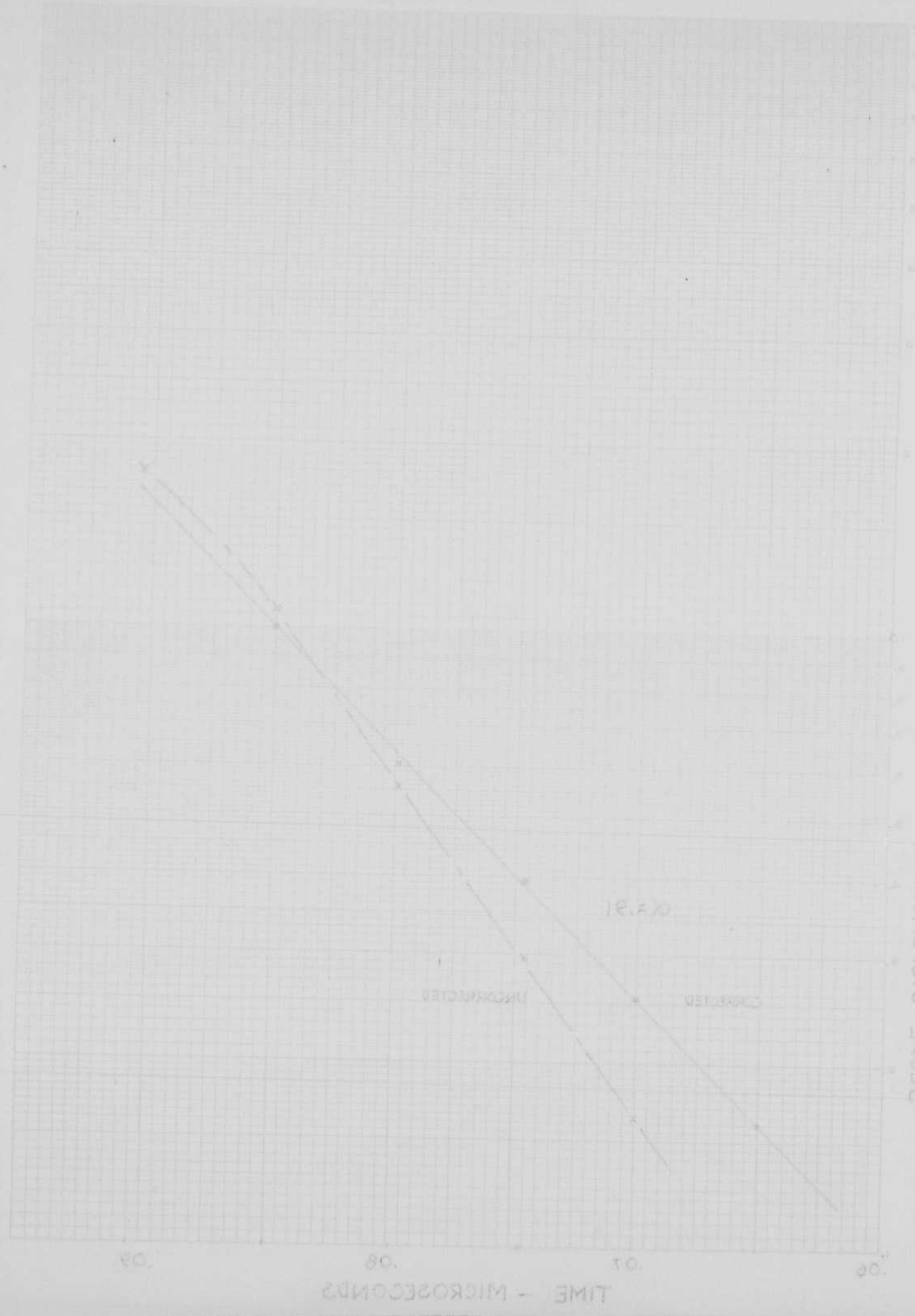

SCOPE DISPLACEMENT - VOLTS

TIME - MICROSECONDS

18.20

UNCORRECTED

CORRECTED

X 931 S.L. PARRY

EUBENE DIETZGEN CO.
MADE IN U.S.A.

NO. 340-L210 DIETZGEN GRAPH PAPER
SEMI-LOGARITHMIC
2 CYCLES X 10 DIVISIONS PER INCH

SCOPE DISPLACEMENT - VOLTS

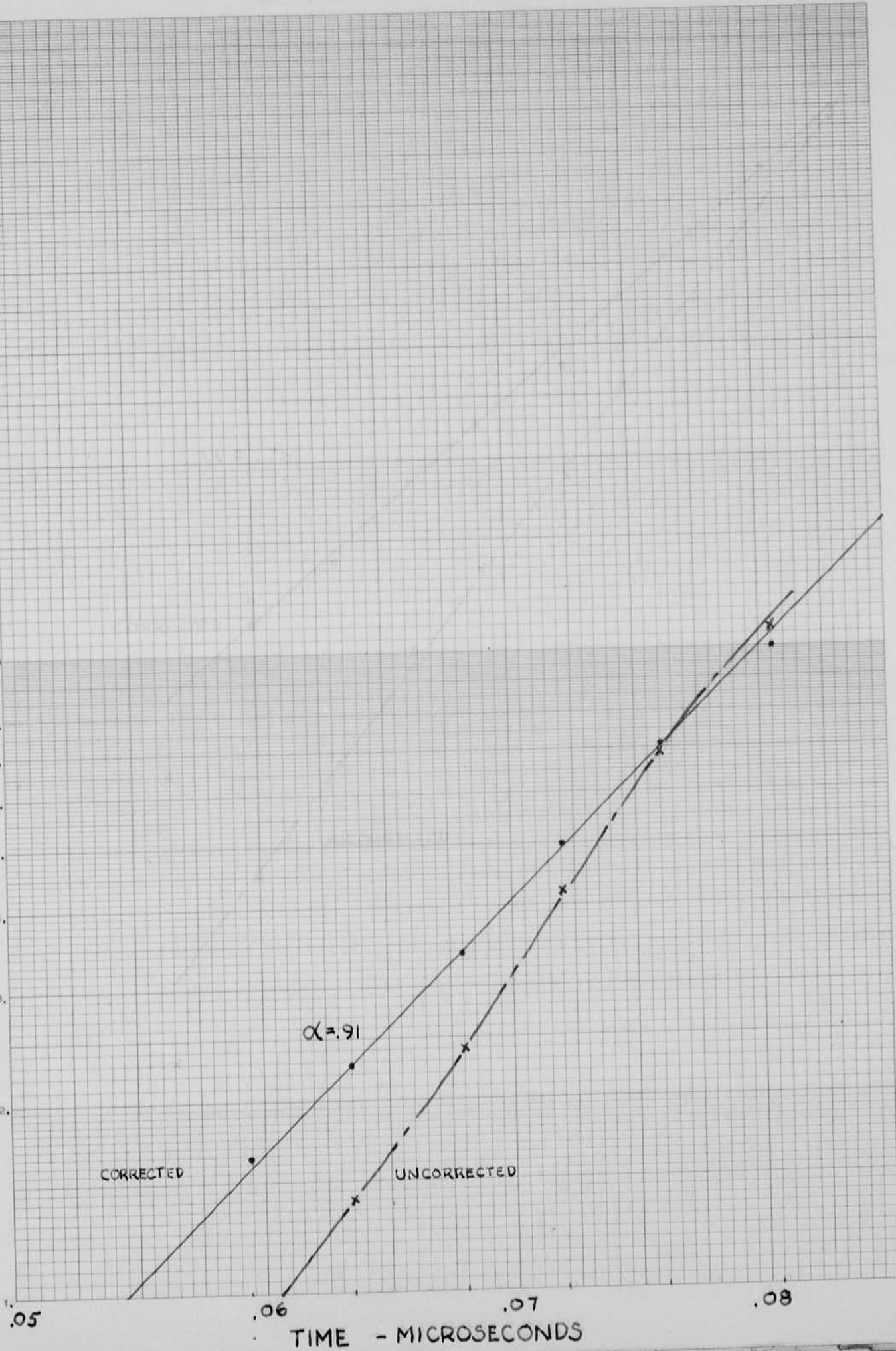

TIME - MICROSECONDS

X 931 S.L. PARRY

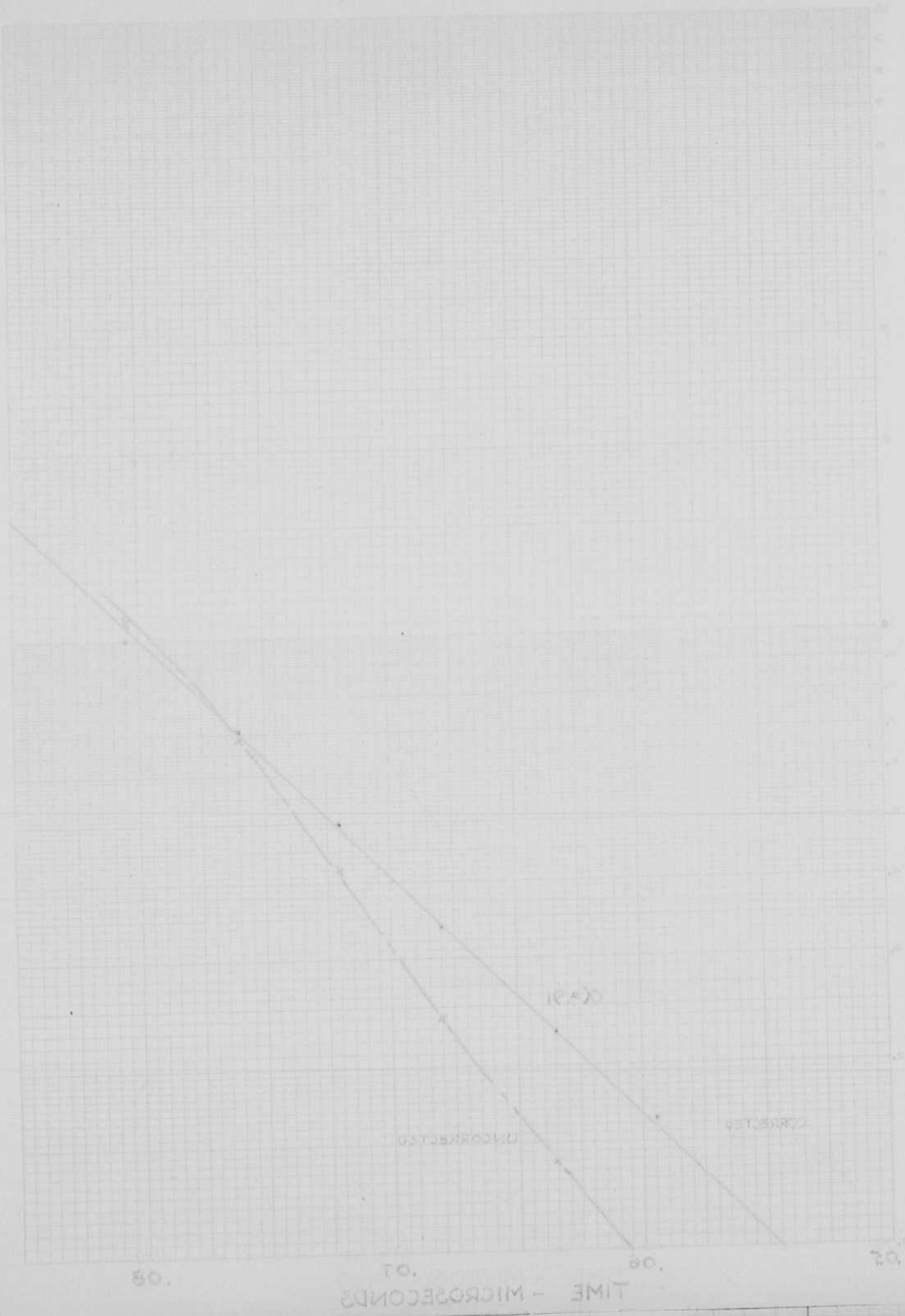

Vertical text on the right side of the page, possibly a reference or identification number.

Vertical text on the right side of the page, possibly a reference or identification number.

Z 935 S.L.

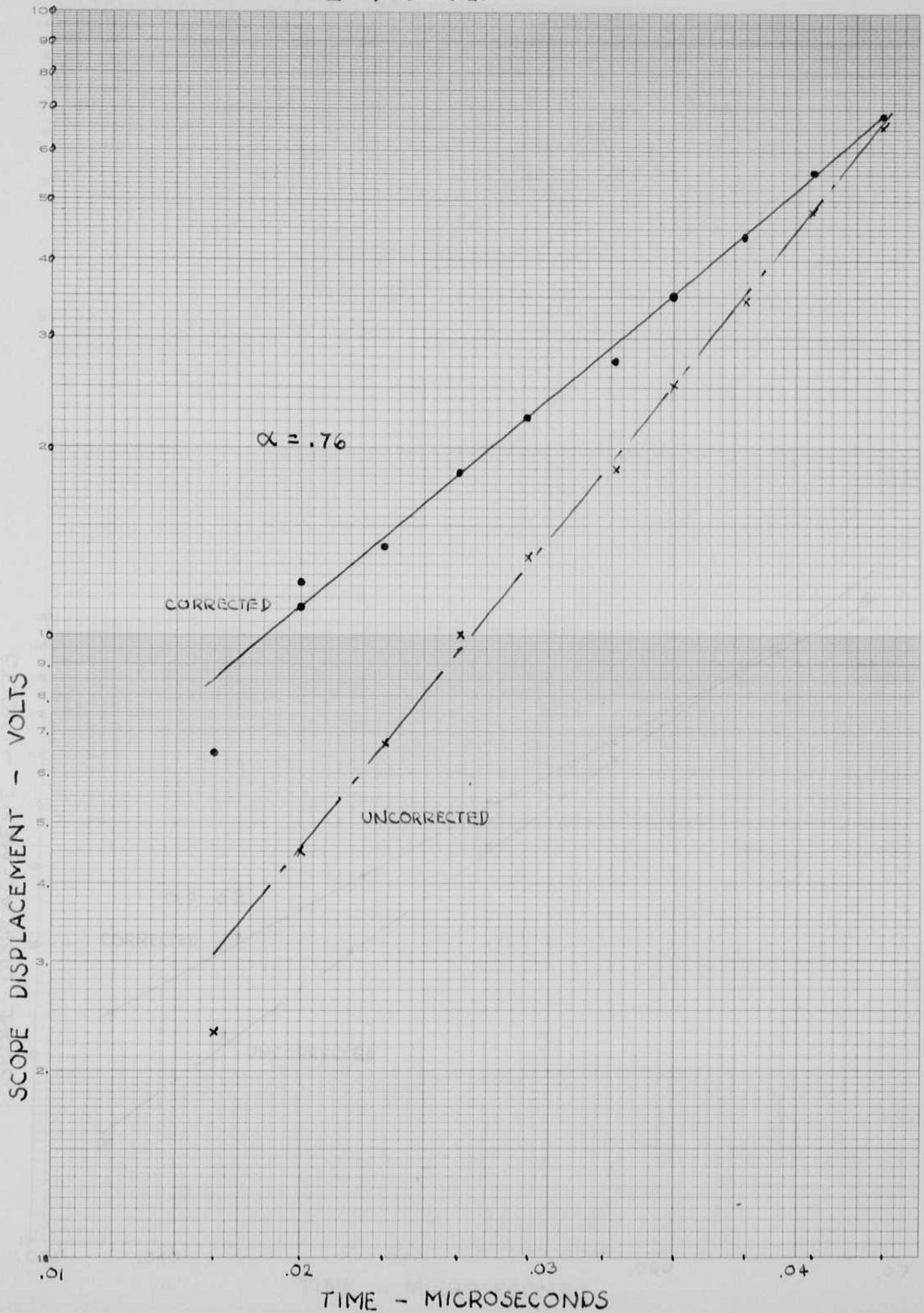

EUGENE DIETZGEN CO.

EUGENE DIETZGEN CO.
MADE IN U.S.A.

NO. 340-1210 DIETZGEN GRAPH PAPER
SEMI-LOGARITHMIC
2 CYCLES X 10 DIVISIONS PER INCH

SCOPE DISPLACEMENT - VOLTS

TIME - MICROSECONDS

Σ 982 81

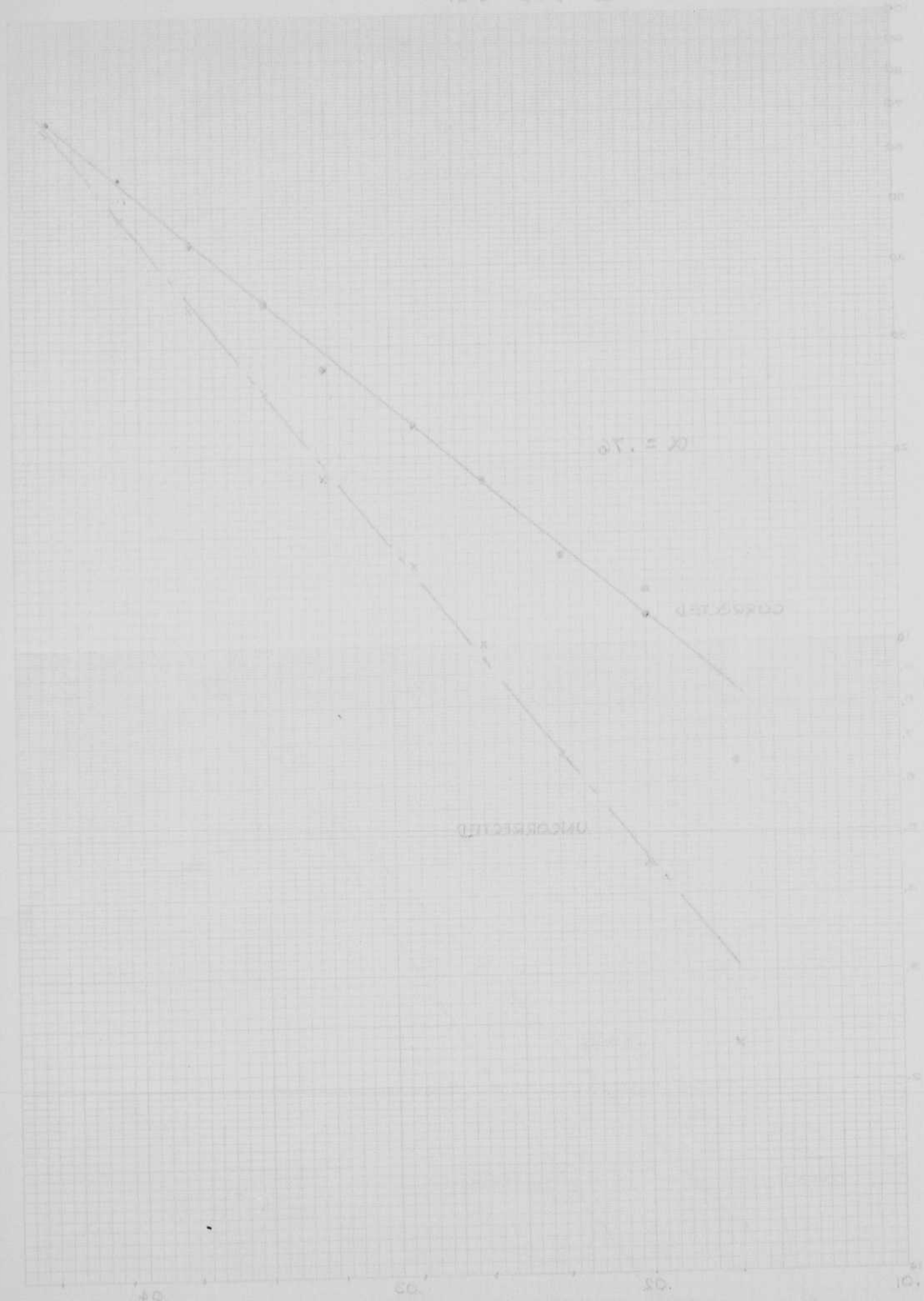

SCAPE DISPLACEMENT - LOG12

TIME - MICROSECONDS
TIME - ΜΙΚΡΟΨΕΥΔΑΝΑ

Handwritten notes and markings on the right side of the page, including a vertical line and some illegible text.

Z 931 S.L. P.

EUGENE DIETZGEN CO.
MADE IN U.S.A.

NO. 340-L210 DIETZGEN GRAPH PAPER
SEMI-LOGARITHMIC
2 CYCLES X 10 DIVISIONS PER INCH

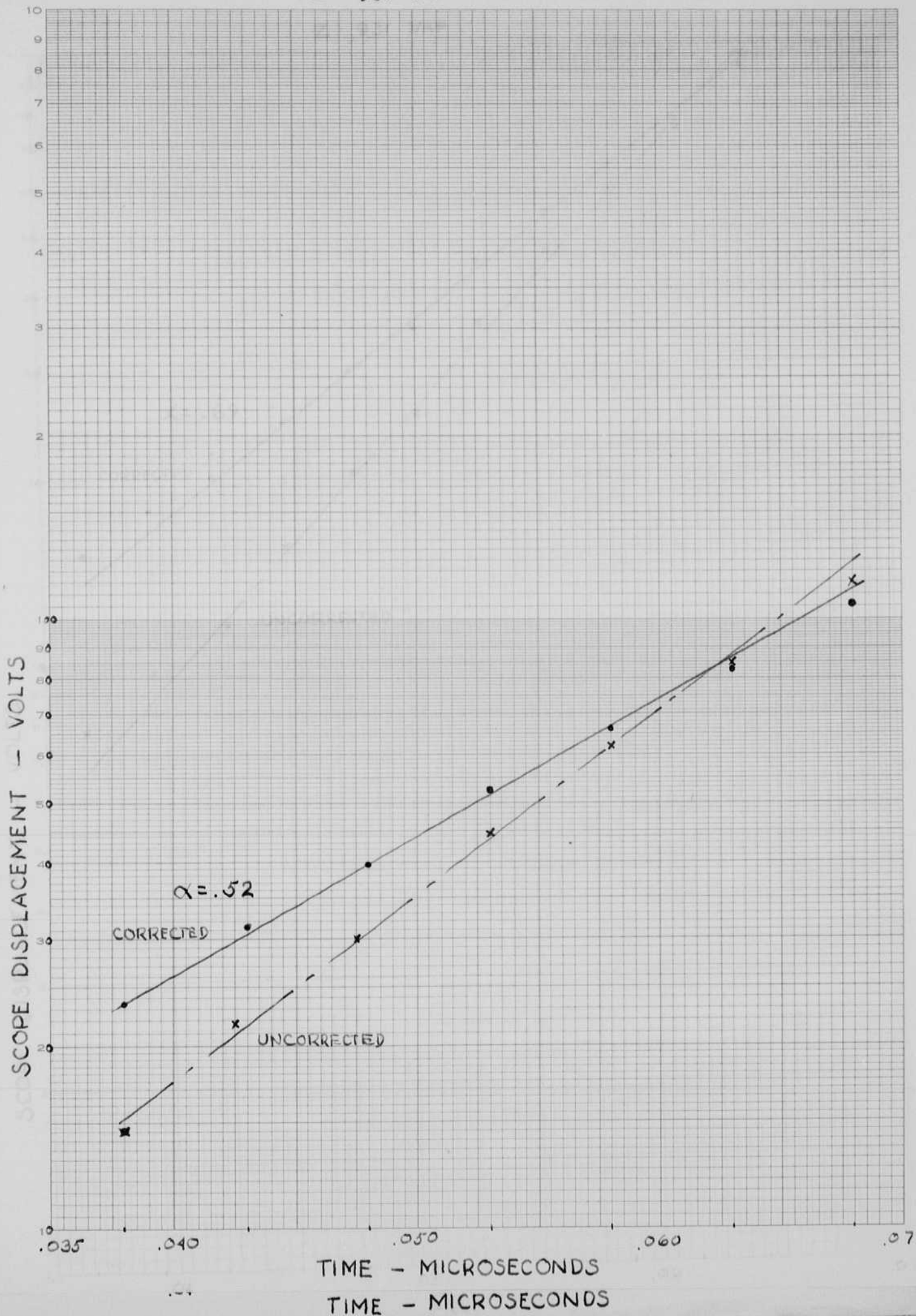

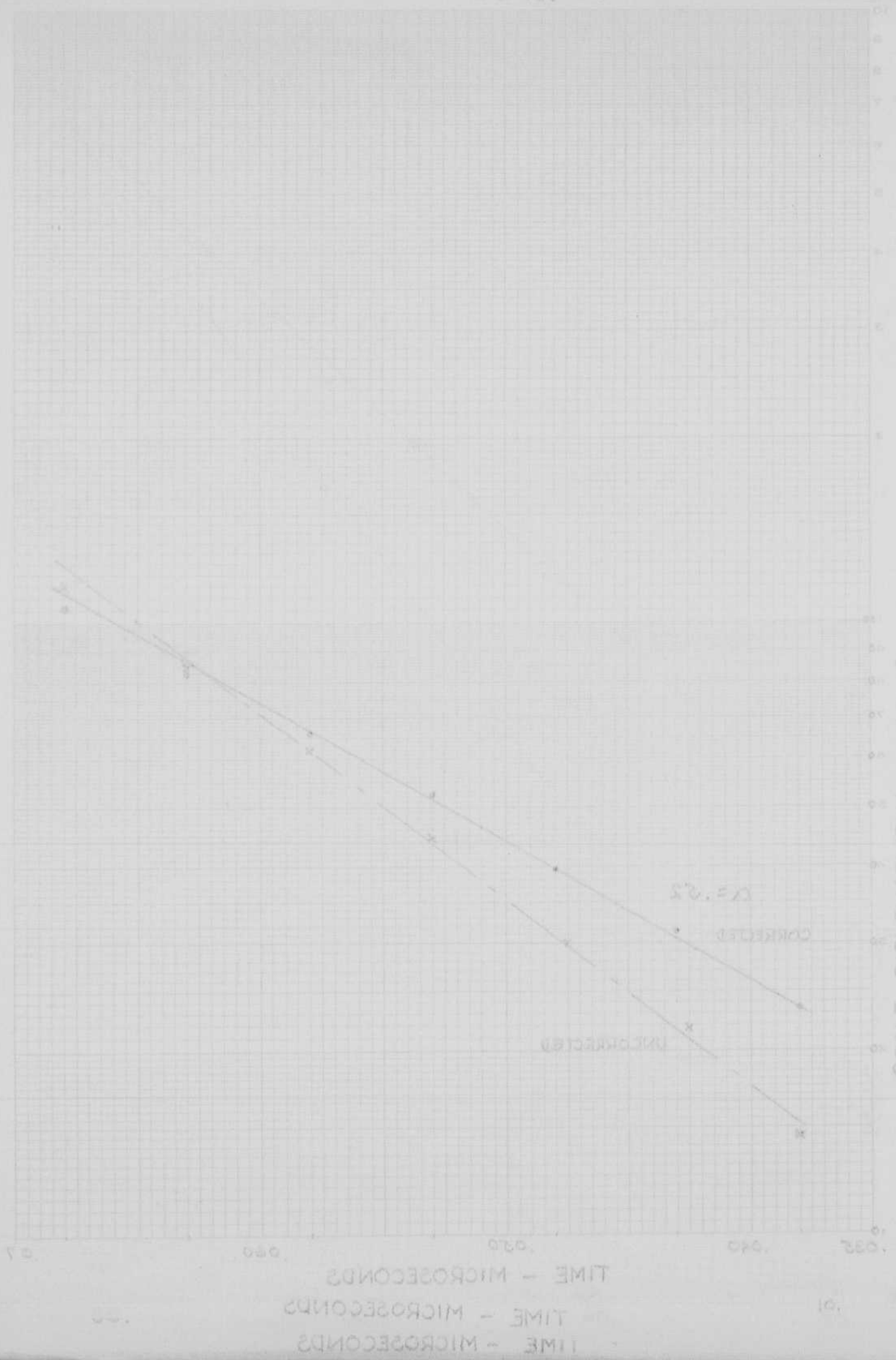

SCOPE DISPLACEMENT - VOLTS

SCOPE DISPLACEMENT - VOLTS

SCOPE DISPLACEMENT - VOLTS

0.07

0.050

0.030

0.010

0.00

TIME - MICROSECONDS

TIME - MICROSECONDS

TIME - MICROSECONDS

0.01

EUGENE DIETZGEN CO.
MADE IN U.S.A.

NO. 340-L210 DIETZGEN GRAPH PAPER
SEMI-LOGARITHMIC
2 CYCLES X 10 DIVISIONS PER INCH

SCOPE DISPLACEMENT - VOLTS

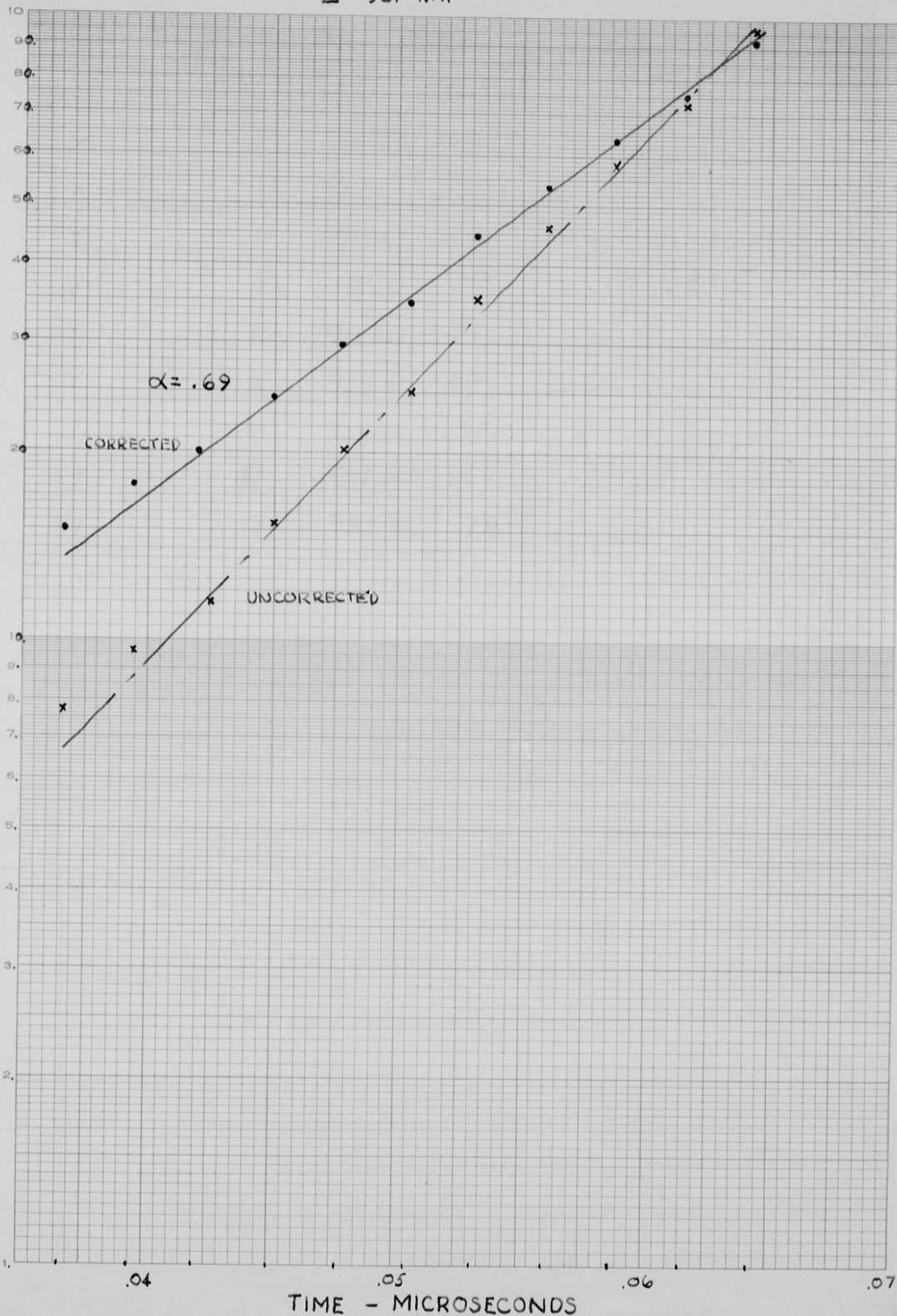

2 321 MAP
P

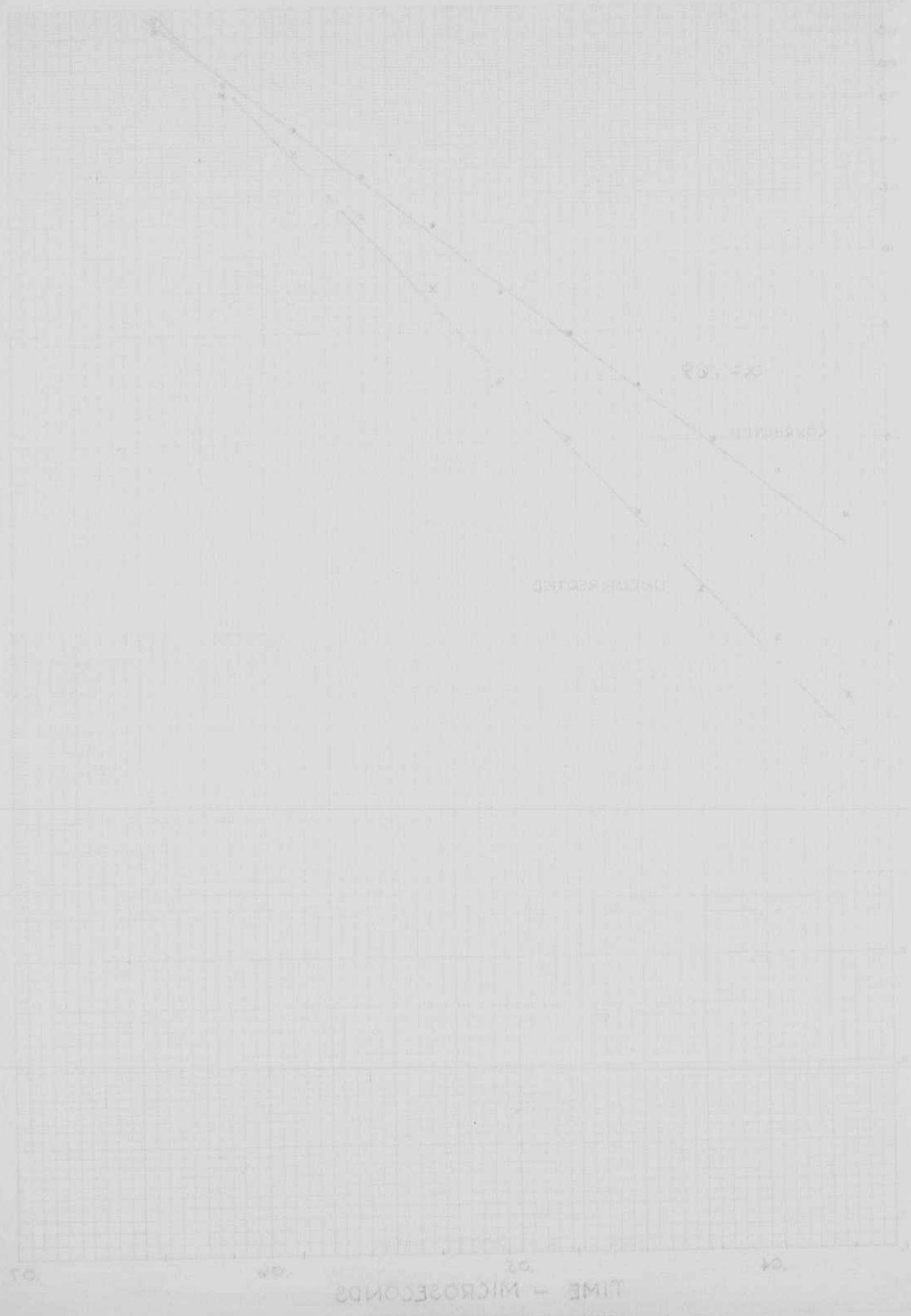

2006E DISPLACEMENT - 10/12

TIME - MICROSECONDS

Shot	Position	tube	α	K
X	P	931 SL	.89	
X	P	931 SL	.91	2.17
Y	P	931 SL	.60	
Y	P	931 SL	.70	.815
Y	A	931 NAP	.77	
Y	A	935 SL	.89	
Z	P	931 SL	.51	
Z	R	931 NAP	.67	.74 .75
Z	R	935 SL	.78	

56
12

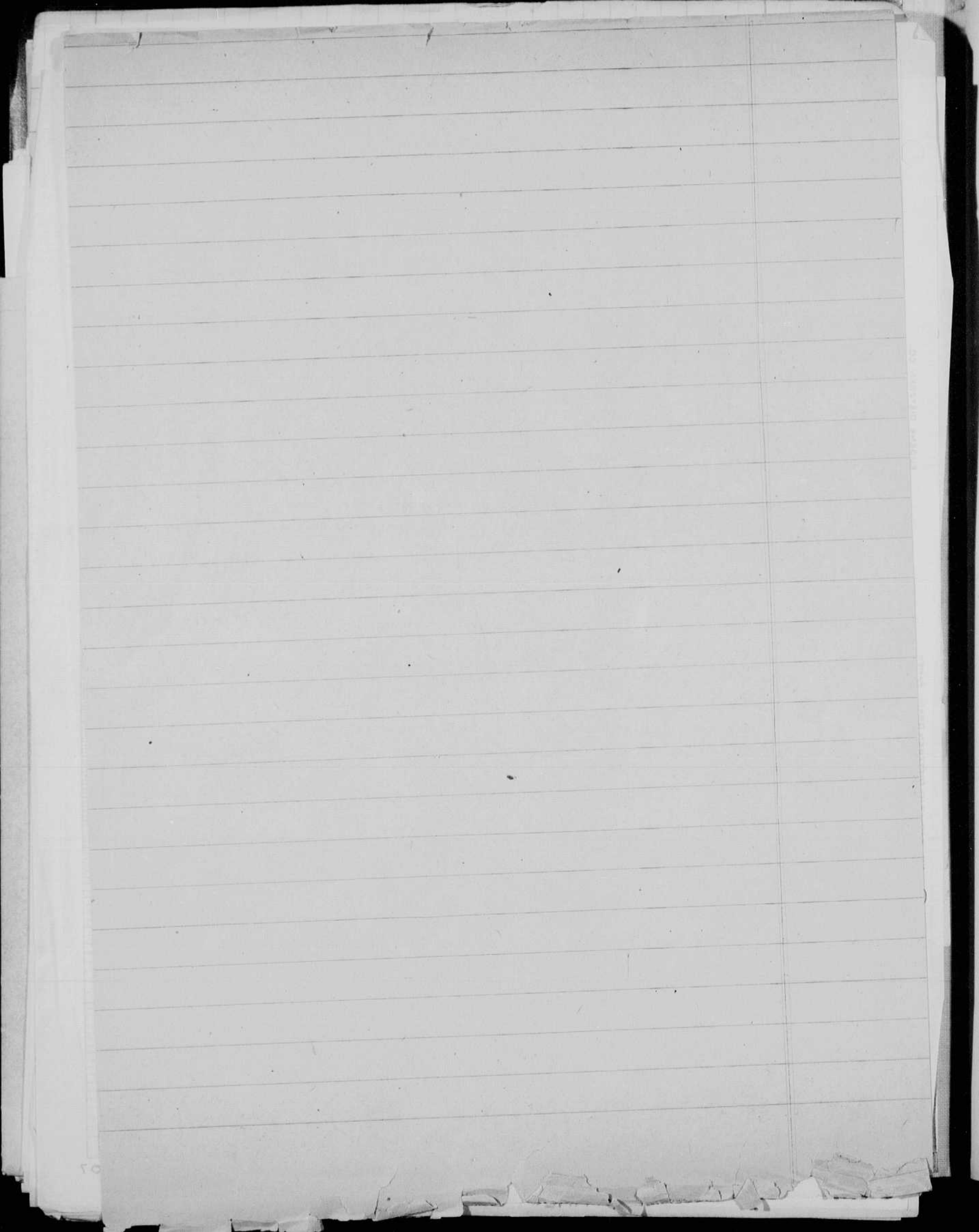

Please return to

Harold E. Edgerton

Room 20D-102

Mass. Inst. of Tech.

Cambridge, Mass.

449 8-12 Apr 15. Group Photo. Braucato

Px 546 7-12.

Magibi P.M. from search lights. 1/200 f 32.

547 - 1

COMPUTATION BOOK

GENERAL INSTRUCTIONS

In all work in which *accuracy* and *ease of reference* are important, much depends upon carrying out the computation in a systematic manner. The following instructions, taken from the *Engineering Department Figuring Book of the Allis-Chalmers Co.*, serve as a guide in this matter.

"All computations, of whatever kind, are to be made in these books, except in cases where special blanks may be provided for specific kinds of computation. Computations may be made in ink or pencil, whichever may be more convenient. Pencil figuring should be done with a soft pencil. All the work of computation should be done in these books, including all detail figuring."

"Each subject should begin on a new page, no matter how much space may be left on the previous page. The subject, with the date of beginning it, should be plainly written at the top of the first page of the subject."

"Work should be done systematically, and as neatly as consistent with rapidity. The books are, however, intended for convenience, and no unnecessary work should be done for sake of appearance only. Errors should be crossed off instead of erased, except where the latter will facilitate the work. Work should not be crowded. Paper costs less than the time which would be expended in attempting to economize space in making erasures."

"Where curves drawn on section paper (or sketches) are necessary parts of a computation, they should be pasted in the book, except where specifically otherwise provided for."

"Computations should be indexed, in the back of the book, by the person using the book."

* * * * *

Notebook # 18

Filming and Separation Record

___ unmounted photograph(s)

___ negative strip(s)

1 unmounted page(s)
(notes, drawings, letters, etc.)

was/were filmed where originally located between page 0 and 1.

Item(s) now housed in accompanying folder.

COMPUTATION BOOK

GENERAL INSTRUCTIONS

In all work in which *accuracy* and *ease of reference* are important, much depends upon carrying out the computation in a systematic manner. The following instructions, taken from the *Engineering Department Figuring Book of the Allis-Chalmers Co.*, serve as a guide in this matter.

"All computations, of whatever kind, are to be made in these books, except in cases where special blanks may be provided for specific kinds of computation. Computations may be made in ink or pencil, whichever may be more convenient. Pencil figuring should be done with a soft pencil. All the work of computation should be done in these books, including all detail figuring."

"Each subject should begin on a new page, no matter how much space may be left on the previous page. The subject, with the date of beginning it, should be plainly written at the top of the first page of the subject."

"Work should be done systematically, and as neatly as consistent with rapidity. The books are, however, intended for convenience, and no unnecessary work should be done for sake of appearance only. Errors should be crossed off instead of erased, except where the latter will facilitate the work. Work should not be crowded. Paper costs less than the time which would be expended in attempting to economize space in making erasures."

"Where curves drawn on section paper (or sketches) are necessary parts of a computation, they should be pasted in the book, except where specifically otherwise provided for."

"Computations should be indexed, in the back of the book, by the person using the book."

* * * * *

Notebook # 18

Filming and Separation Record

___ unmounted photograph(s)

___ negative strip(s)

1 unmounted page(s)
(notes, drawings, letters, etc.)

was/were filmed where originally located between page 0 and 1.

Item(s) now housed in accompanying folder.



935 phototubes. V.A. char.
Cathode follower. 6SN7 parallel.

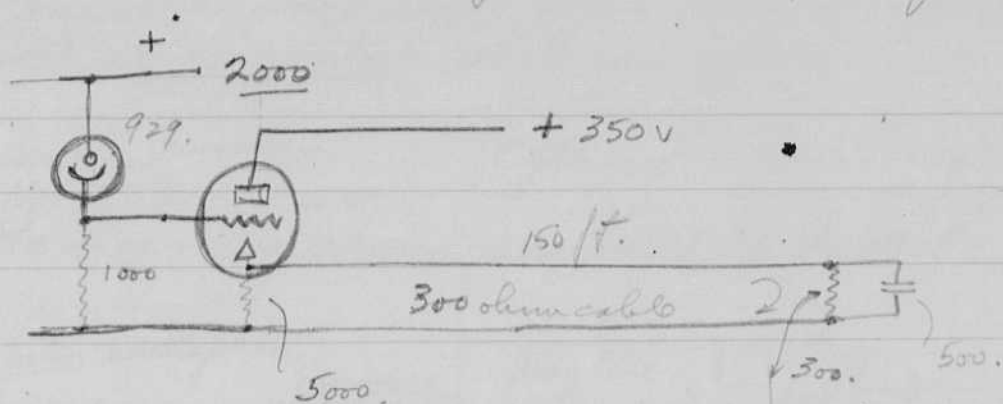

$$i = A \epsilon^{\alpha t}$$

$$e_c = \frac{1}{c} \int i dt = \frac{1}{c} \int A \epsilon^{\alpha t} \frac{dt}{\alpha}$$

$$= \left(\frac{A}{c \alpha} \right) \epsilon^{\alpha t} \quad i_c = C \frac{de_c}{dt}$$

$$= B \epsilon^{\alpha t} \quad i_c = C B \alpha \epsilon^{\alpha t}$$

$$i_R = \frac{B \epsilon^{\alpha t}}{R}$$

$$i_c + i_R = B \left(C \alpha + \frac{1}{R} \right) \epsilon^{\alpha t}$$

$$\text{Let } i_t = A \epsilon^{\alpha t}$$

$$A \epsilon^{\alpha t} = B \left(C \alpha + \frac{1}{R} \right) \epsilon^{\alpha t}$$

$$B = \frac{A}{C \alpha + \frac{1}{R}} = \frac{A}{.0532}$$

$$\frac{1}{500} + \frac{1}{300} = 188 A$$

$$e_c = 188 A \epsilon^{\alpha t}$$

$$\alpha = 10^{+8}$$

$$C = 20 \times 10^{-12}$$

$$C \alpha = 20 \times 10^{-4} = \frac{1}{500}$$

$$\frac{1}{C \alpha} = .0500 \text{ ohms.}$$

$$\frac{1}{R} = \frac{1}{300}$$

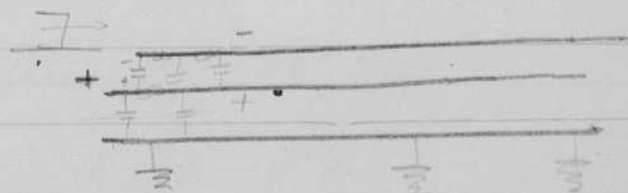

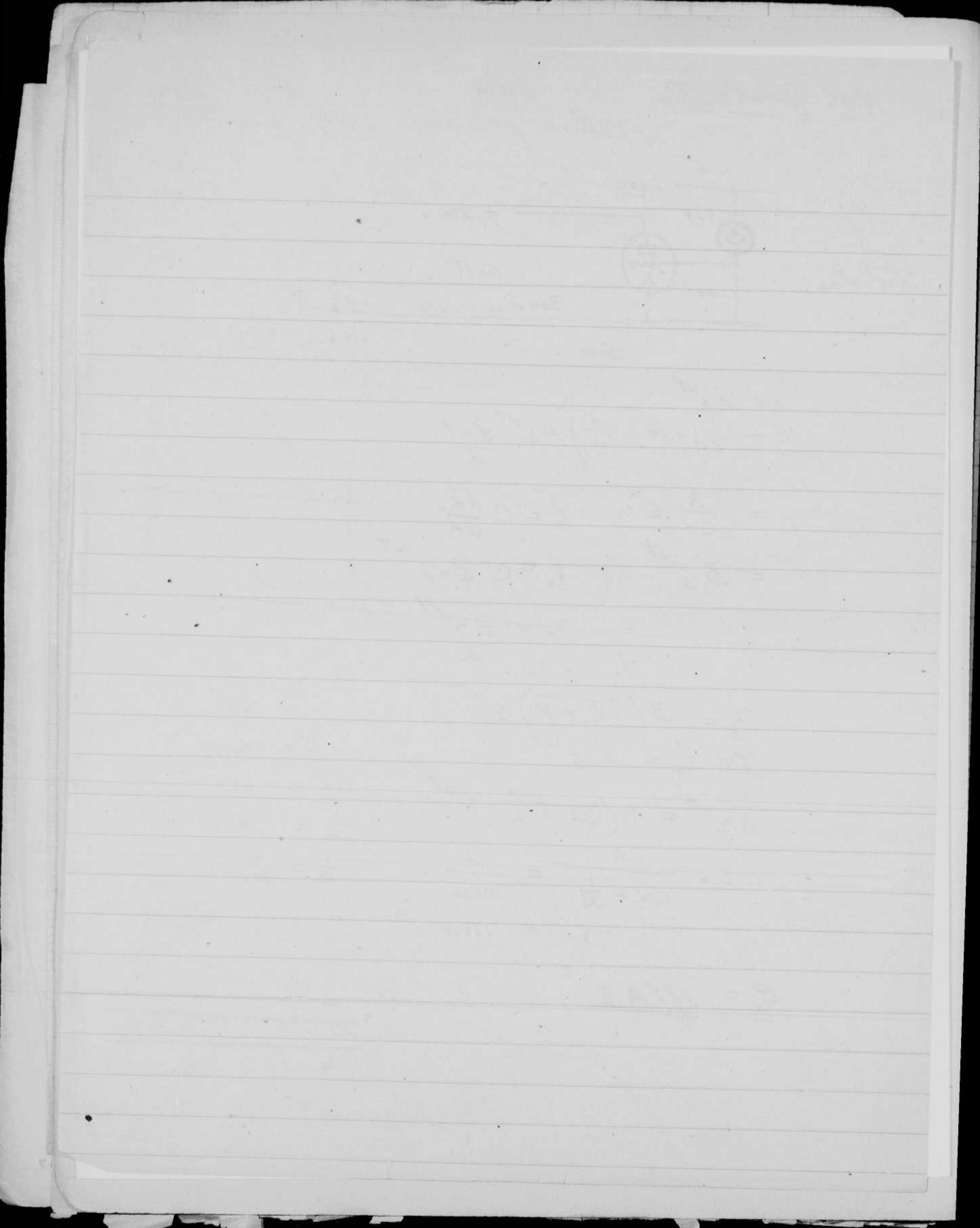

Jan 28 1948

David E Edgerton

Conf. with Lew Fussel about measurements to be made at Eniwetok atol in spring.

Doral Froman Ogle Linnenburger Los Alamos.
N.R.L. Dr. Krause.

Rate meas. by scheme suggested by Fussel

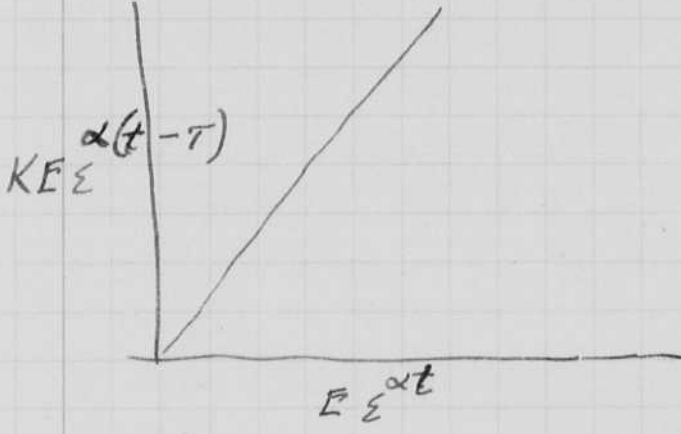
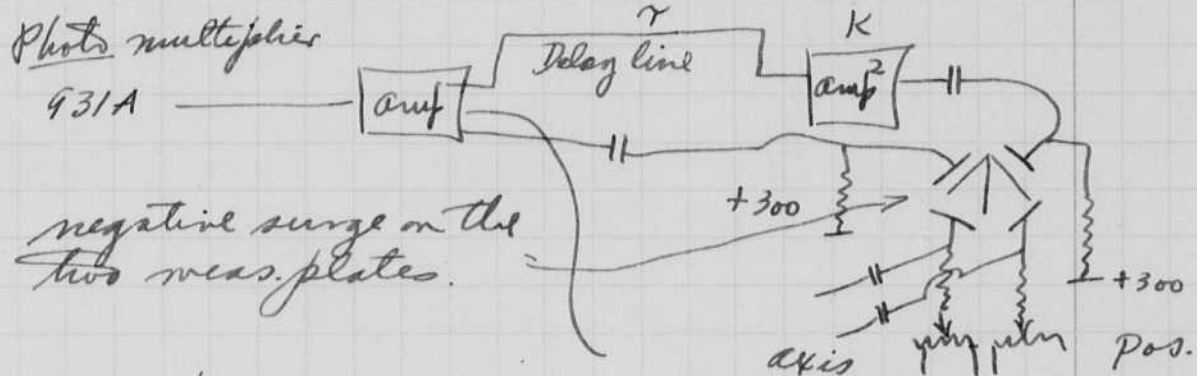

Signal to transit exp.
N.O.L. circular sweep for tuning the signal with the -100 ns. trip.

45° if $KE \epsilon \alpha(t - \tau) = E \epsilon^{\alpha t}$
 $\ln K + \alpha(t - \tau) = \alpha t$
 $\ln K = \alpha \tau \quad \alpha = \frac{\ln K}{\tau}$

Distance to observation station is 1300 yards, also about 14 miles.

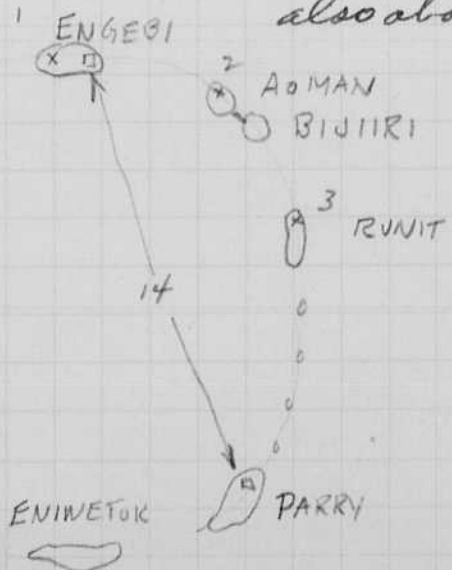

RCA Amplifiers Camden
D. H. Ewing. Telrand Dir.
E. Eberhard Proj. Eng.

Dumont 25. scope
1- December. Elect. type.
6- Jan 15 delivery. (4 NRL.)
6- Jan 24.

Oscillograph Power Supplies, Jan 30, 1948.

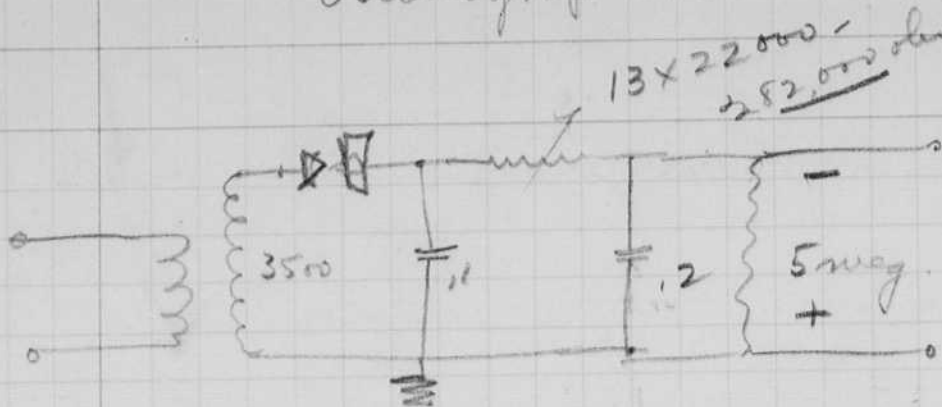

100	3.46K
110	3.77
115	3.95
170	4.12
125	4.25.

Sorenson Regulator

Vac	DC. on scope
100	4550
110	4520
120	4500
130	4600
100	4540
115	4490

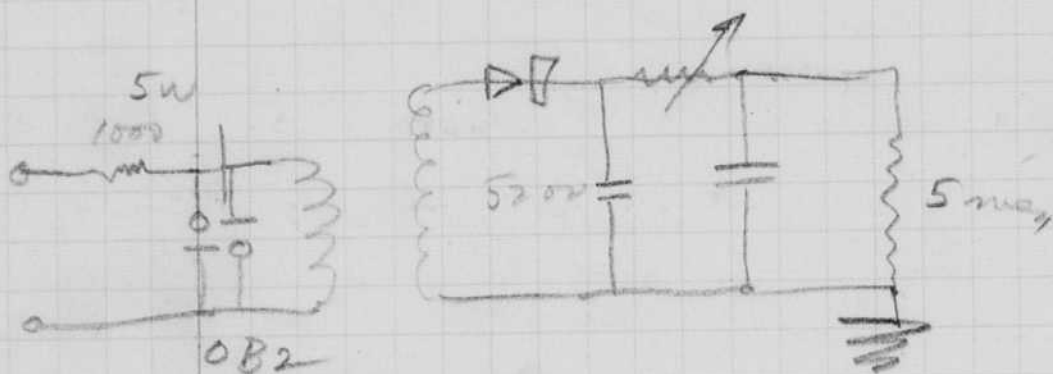

Dumont CR type 319 serial 111 Sensitivity tests,
 Variac control on anode.

V ₁	V ₂	Deflection for 112V RMS.
3400 volts.	0	8.6 cm
3500	0	9.6
4000	0	8.3 cm
4000	5000	7.2
4000	9000	6.3
4000	0	8.8 cm
4000	0	10.8

other axis (D₁, D₂)

with R.F. Supply.

4	25 KV±	5 cm
3.6	25 "	5.8
4.4	25 "	4.5
4.0	10	7.2
4.0	13	6.5

Sens. $\frac{V}{cm}$
 63. $\frac{160 V}{inch}$

DuMont information per Call Koch to Calson

A ₂ kv	A ₃ kv	V/in	
4	25	225	(D ₁ D ₂ - facing screen)
4	22.5	215	
3.6	25	215	
3.6	22.5	205	

i.e. 10% change in either voltage gives a 5% change in Sensitivity, and both changing together cause a 10% change

Our data

If line voltage goes up 10% we can expect a 5% change in Sensitivity because of change in 25KV, and 13% because of change in 4KV. These are in the same direction so total change is 18% or about $\frac{3}{8}$ " at 2" deflection. If we let positioning voltage vary directly with line voltage the net change in deflection would be only 8% or about $\frac{1}{6}$ " at 2" deflection. OK?

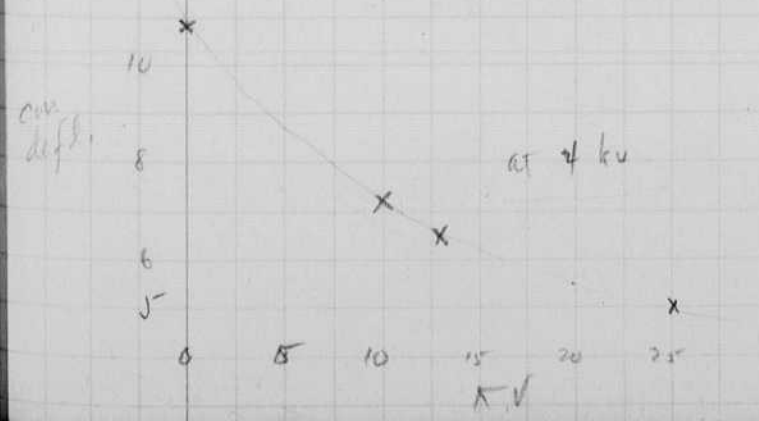

S changes ~ 10%
for 20% change
in 25KV

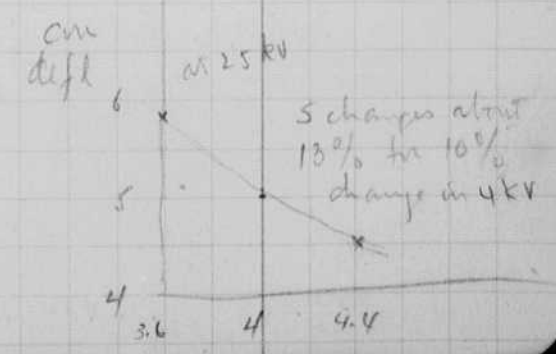

4

Regulator tests:

Jan 31 1948
David S. Edwards

Serial No. 464 Symonson Regulator,
Model 250. watts.

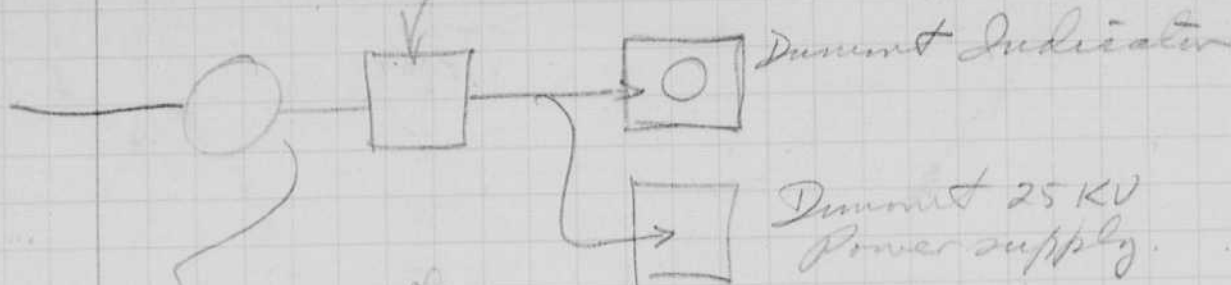

Vacuum DC volts.

105	4650
110	4650
115	4650
120	4650
125	4640
105	4650
100	4660

C.R. circuit 112 volts

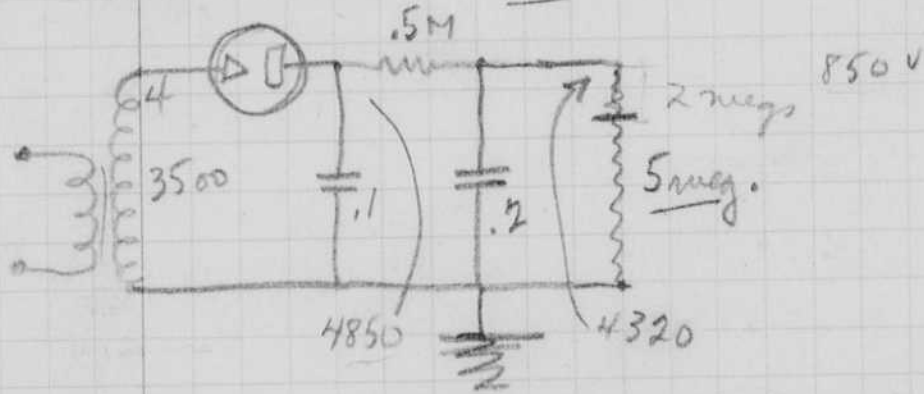

Main def circuit.

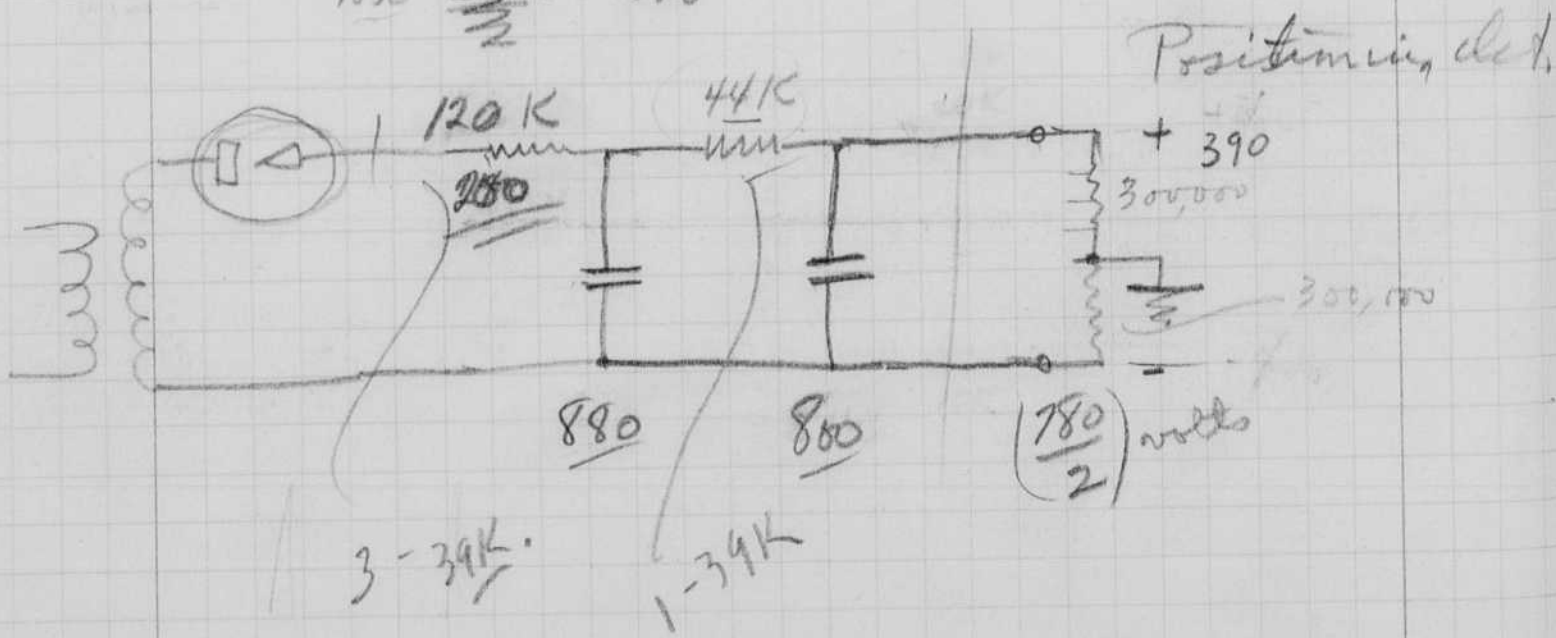

Positioning def.

Scope circuit

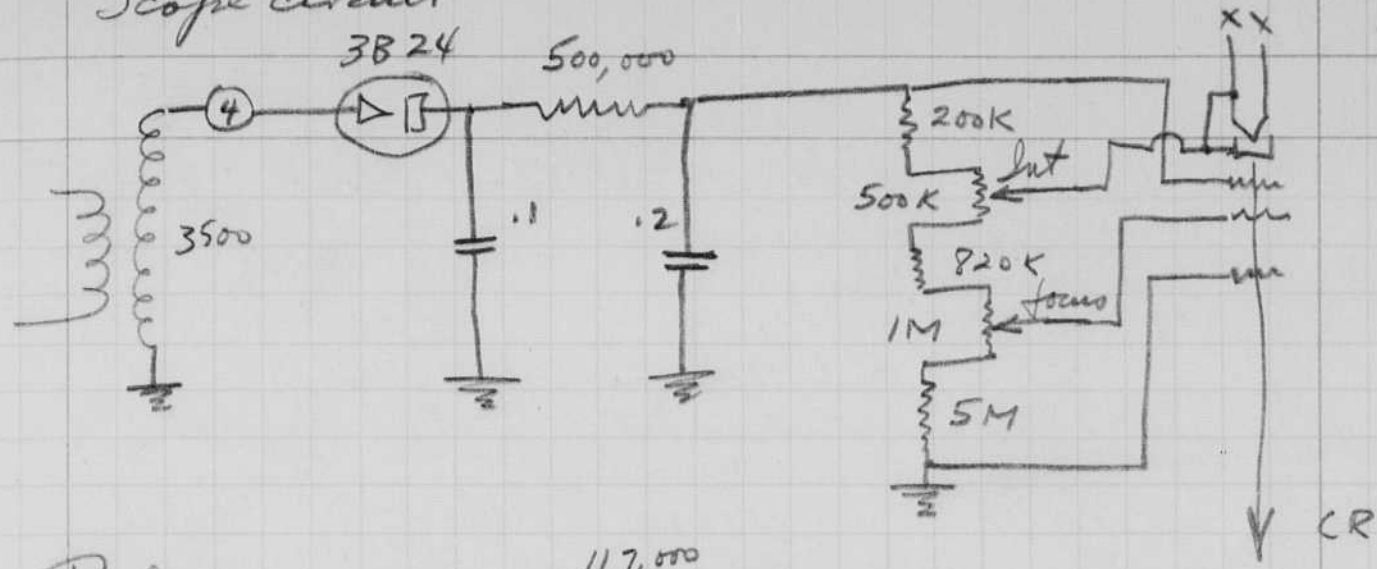

Position circuit

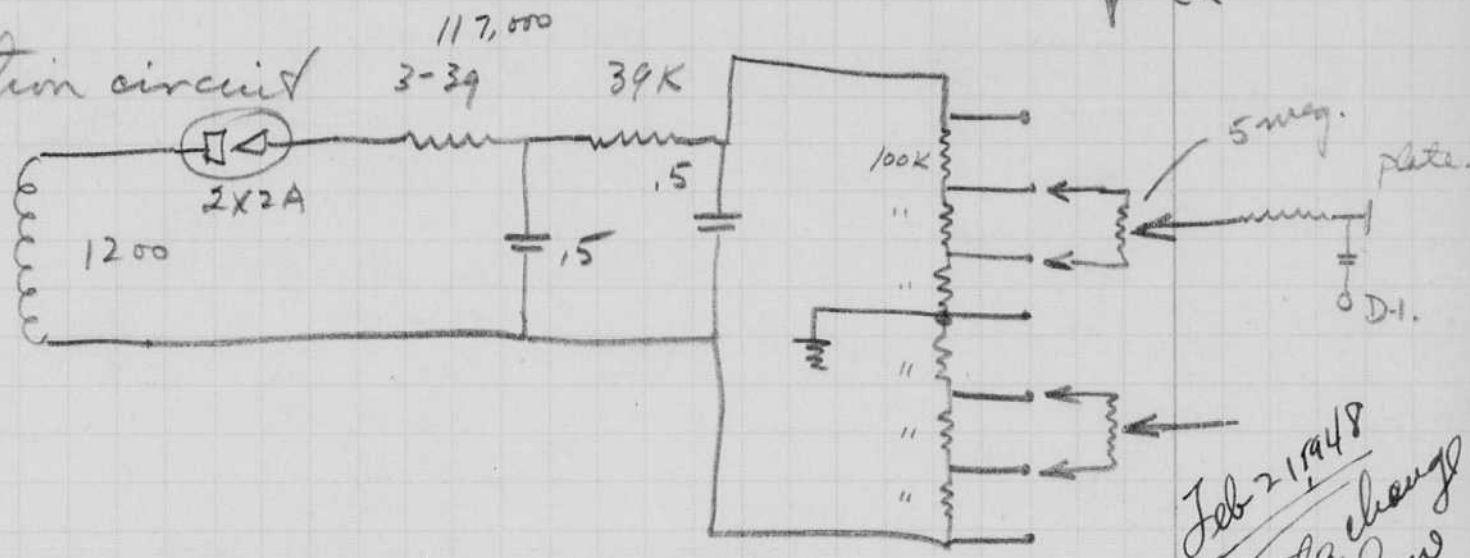

Suggested Intensifier circuit.

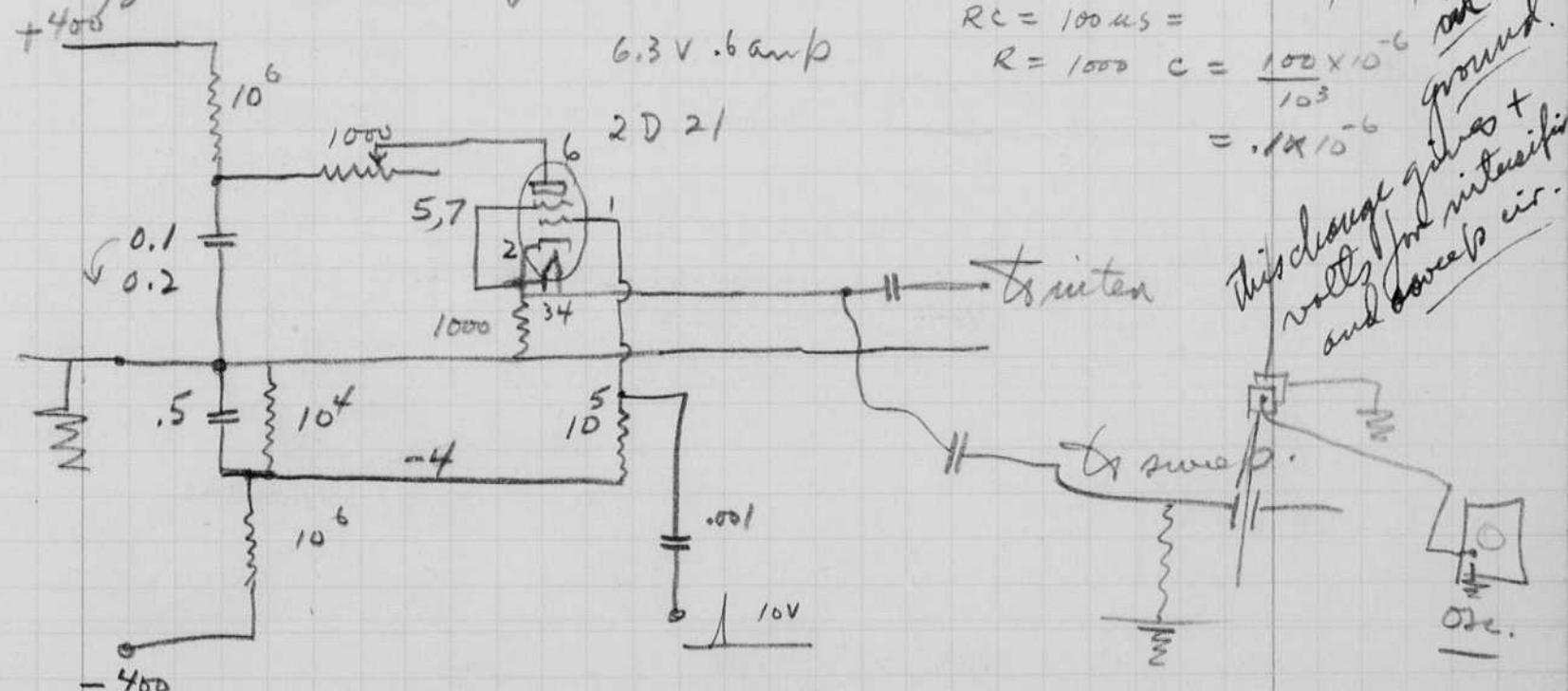

$RC = 100 \mu s =$
 $R = 1000 \quad C = \frac{100 \times 10^{-6}}{10^3}$
 $= .1 \times 10^{-6}$
This charge gives + volts for intensifier and sweeps air.

Feb 21, 1948
note change below in ground.

Pos circuit

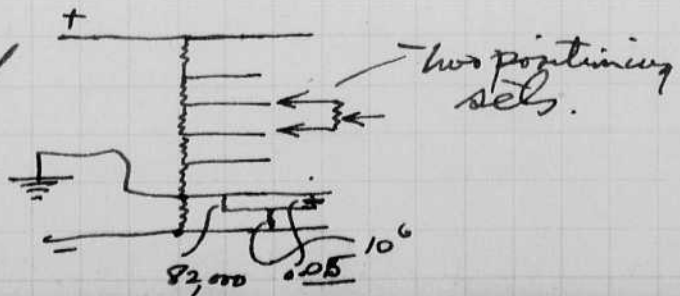

6

Feb 7, 1948
H.E. Edgerton.

21 Feb. Leave Boston for AV5.

20-28 Feb H. Allen - shipping. (Food) proc.
↳ Close.

10 March air lift.

P. J. O'Keefe

M. F. Warchel

R. H. Morris

Drake

Armstrong.

Didesco.

14 Feb.

21 Feb.

25 Feb - Boat. - AV5. H. Grier

Ed Colson

Larry Smith

Army -

Army -

Eberhardt.

H.E. Edgerton.

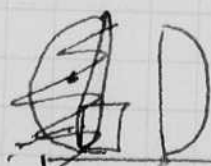
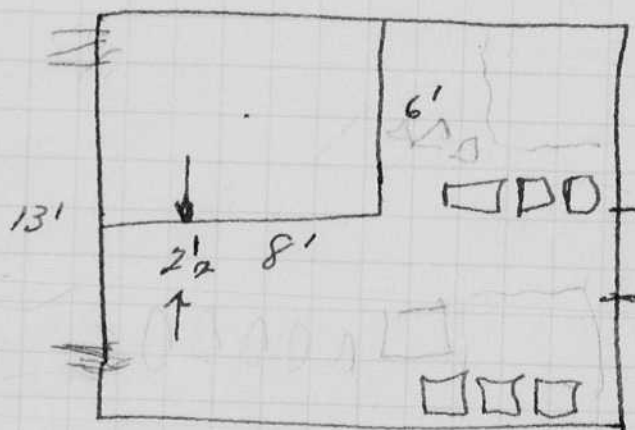

21'

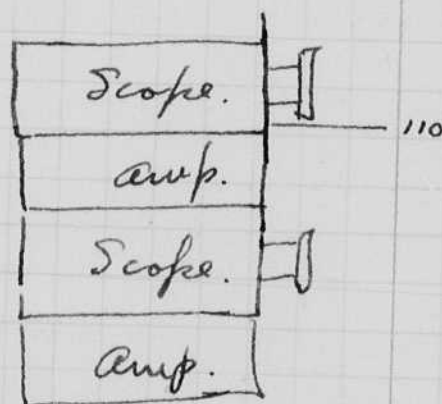
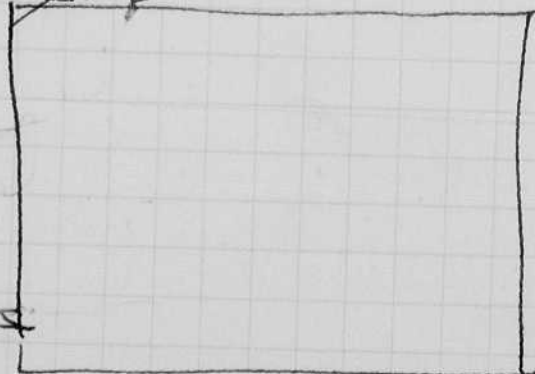

21" available.

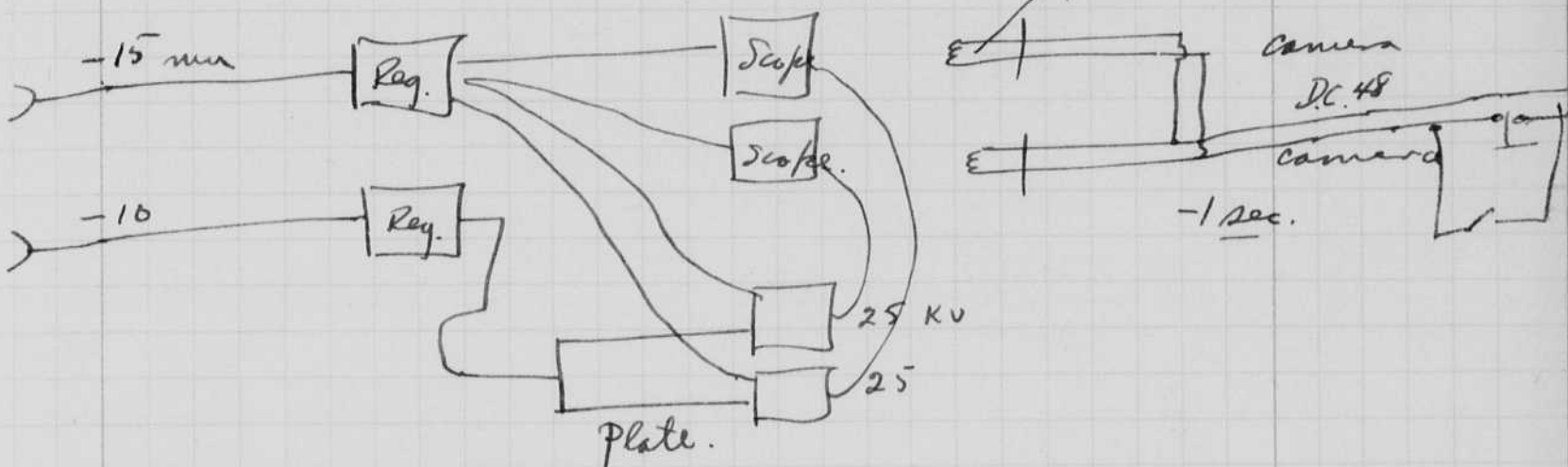
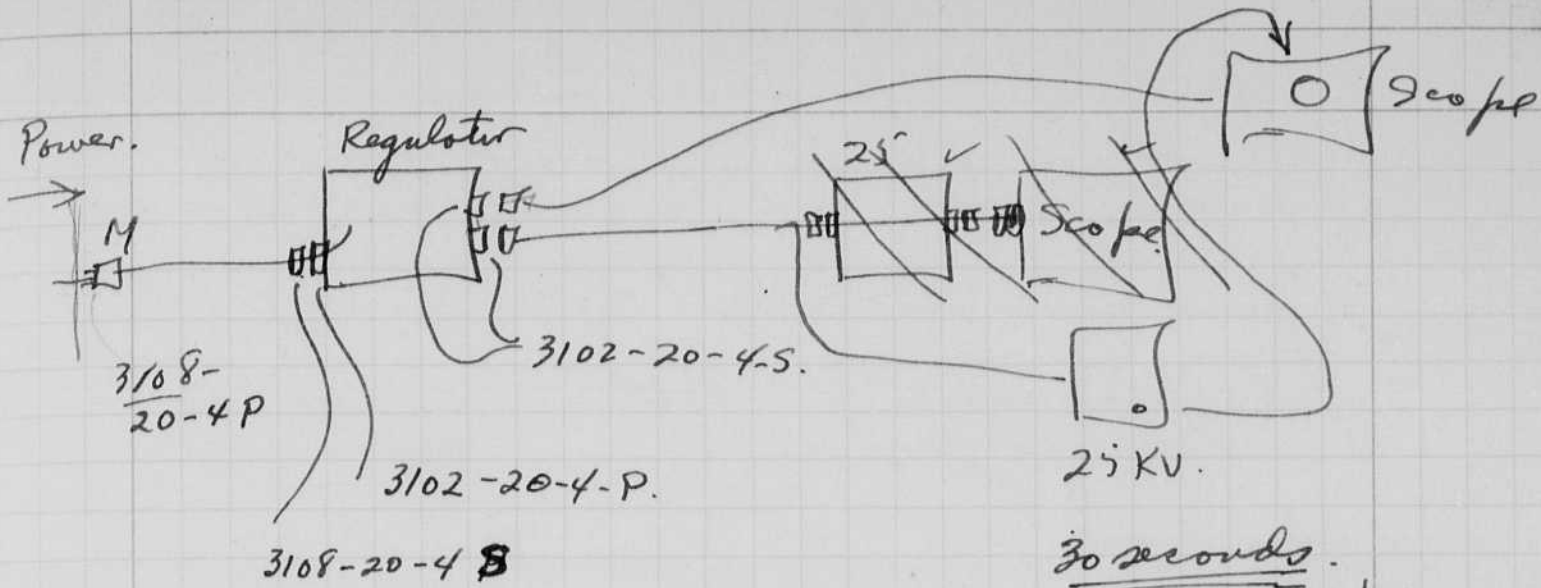

4 march control wiring air cond.
1 mar AV5 sails.

Mar. 4-12 Biijivi

Mar. 12-19. Runit.

16 march - unload -

16-23. Photo elect on island

16-27. control station.

~~16-27~~ Two weeks delay.

Leave by air at last minute

Mar. 10

Mar 15 arrive.

CR Indicator #111.

-102 volts on intensity grid cutoff 4000 V.
 106 4000 + 25,000

Defocus blur with 300 volt pulse on
 Spot appears ok with 250 volt intensity pulse
 with -250 on the grid.

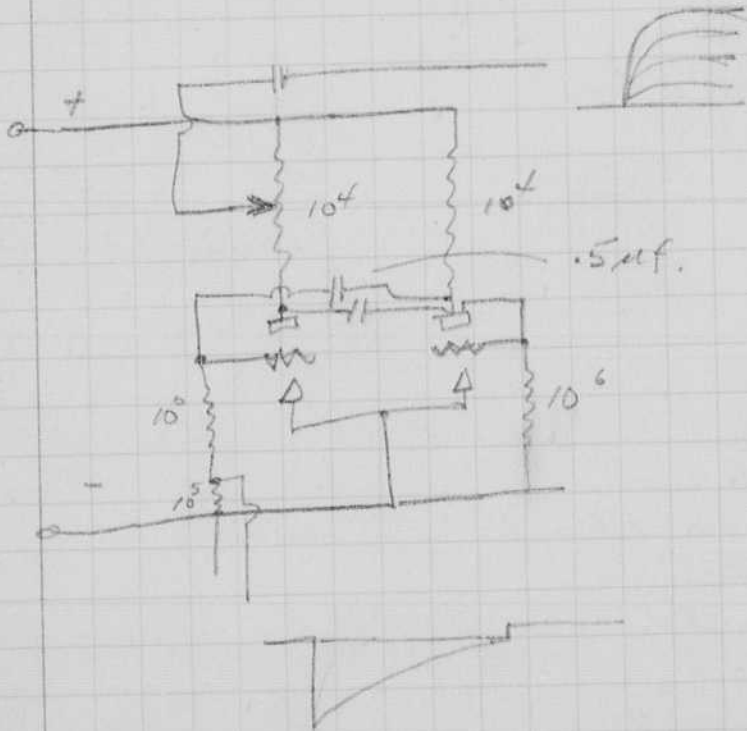
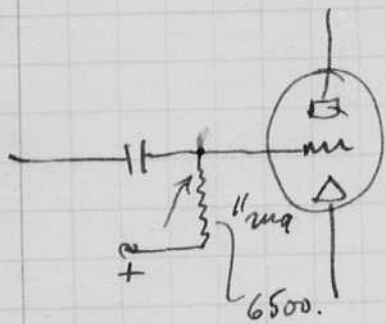
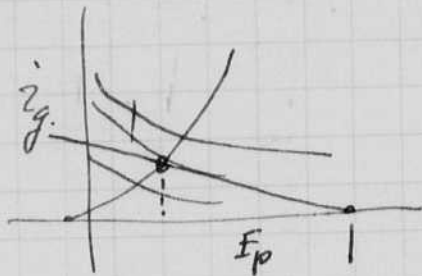

Multivibrator
Signal generator

Intensifier Circuit

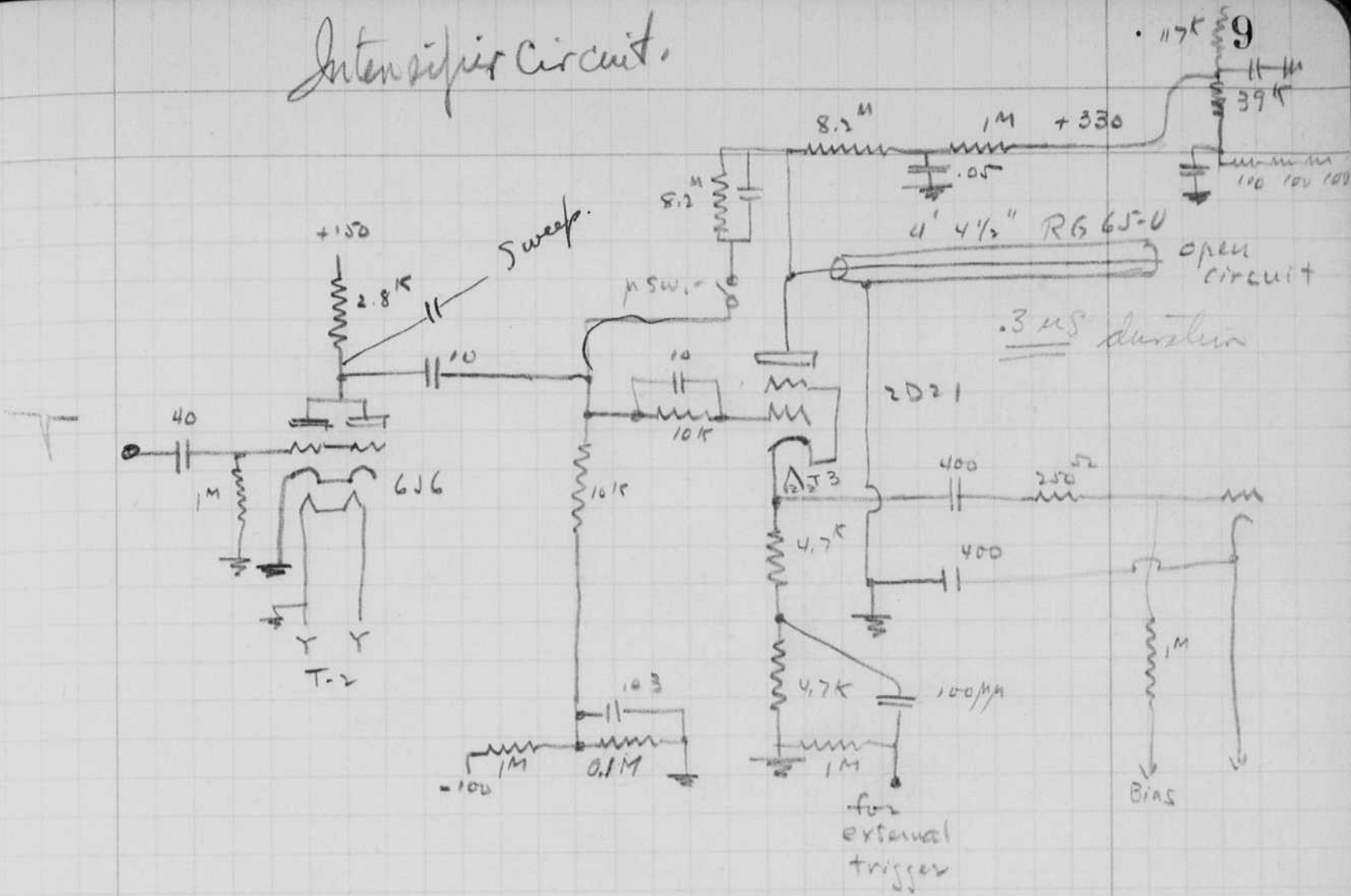

Feb 8 Sunday 1948

Photo multiplier circuit

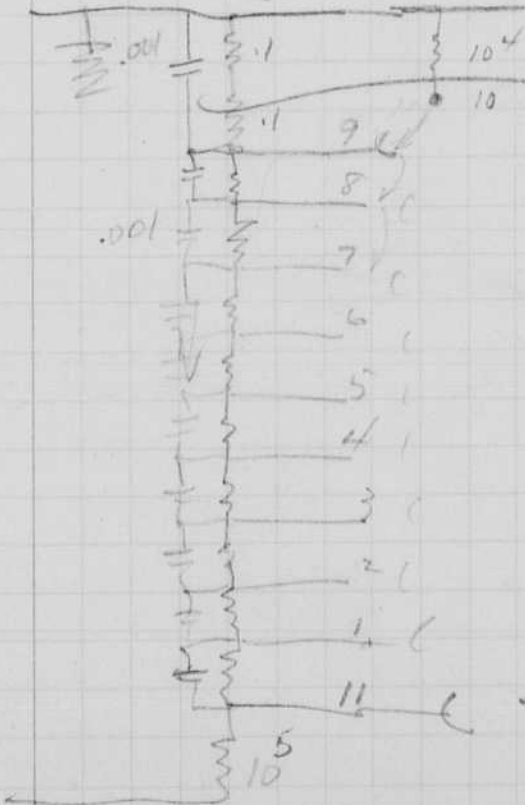

$i = C \frac{dv}{dt}$
 $dt = 10^{-6}$
 $dB = 10$
 $C = .001 \times 10^6$ go to dynode 9.
 $i = \frac{10^{-9} \cdot 10}{10^{-6}} = \frac{10^{-8}}{10^{-6}} = 10^{-2} = .01 \text{ amp}$
 output = $10^{-2} \times 10^4 = 100 \text{ volts}$

900 volts total on strings.

Spark from 50 ft cable at 5 ft gives $\frac{1}{2}$ " deflection when scope has 4KV + 25 KV.

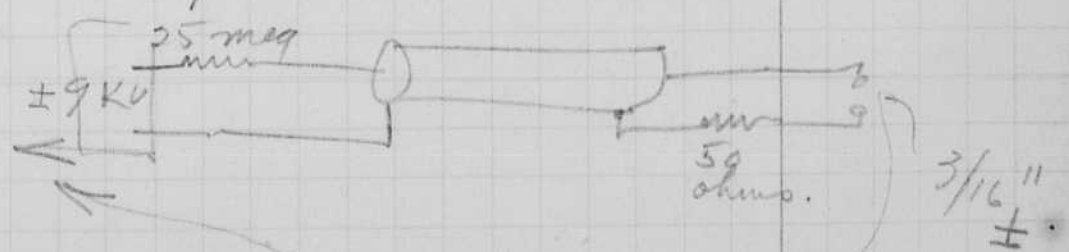

Sweep

2D21
 3-4 cathode heat
 2 cathode
 1 grid
 5-7 grid 2
 6 plate

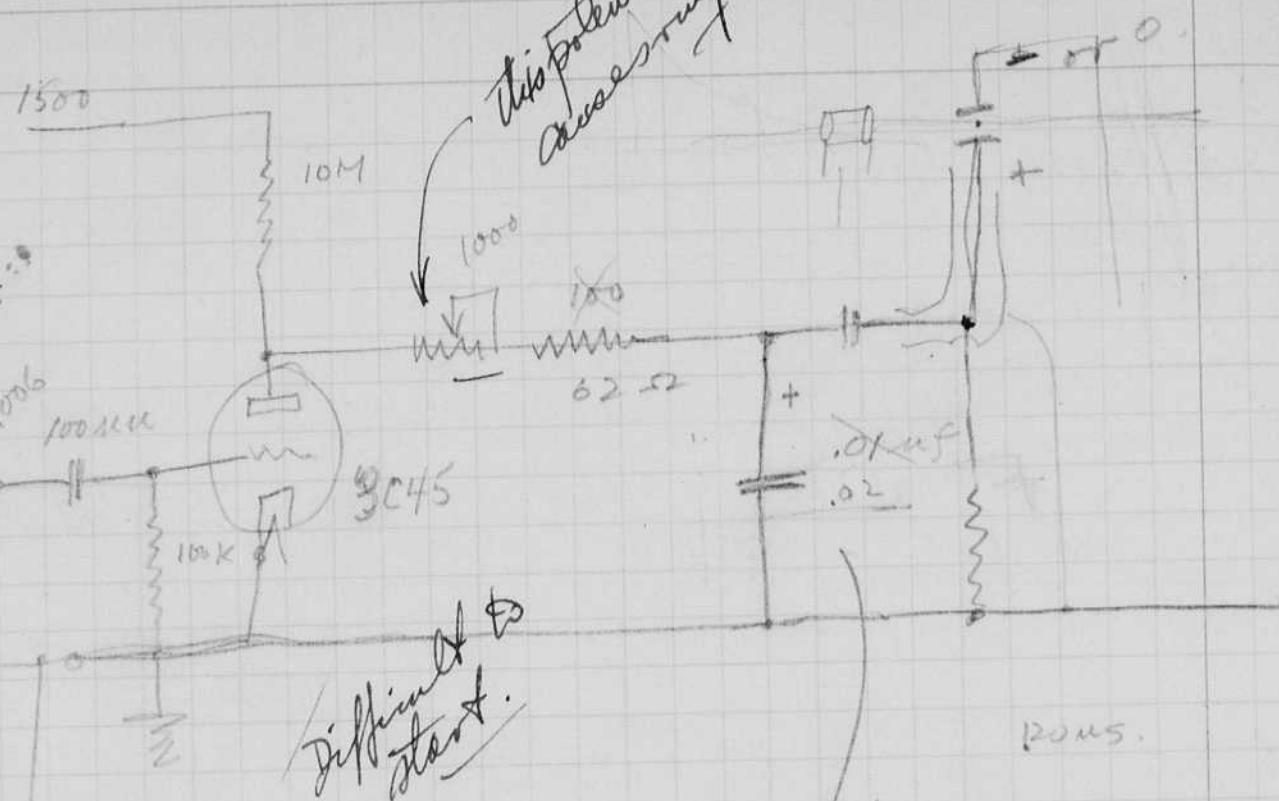

Sweep speed time const = $10^{-6} = RC$
 $R = \frac{10^{-6}}{10^{-8}} = 100 \text{ ohms}$

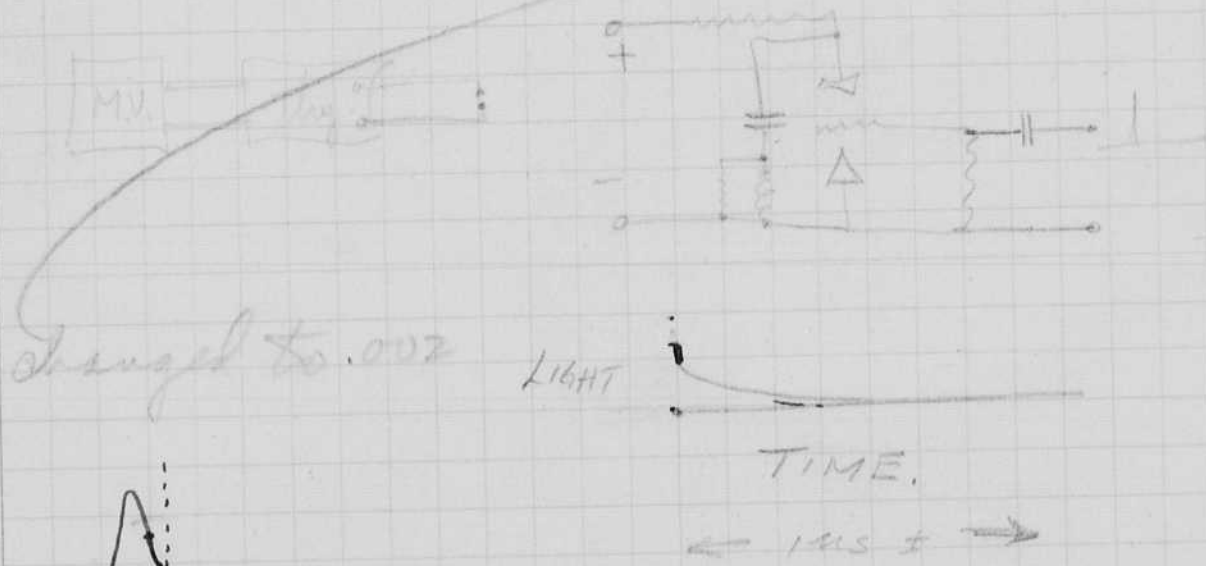

Howard Edgerton.
Feb. 9, 1948.

11
27 μ per ft. 54 A/U.

Spec Sweep tube changed to 2D21.

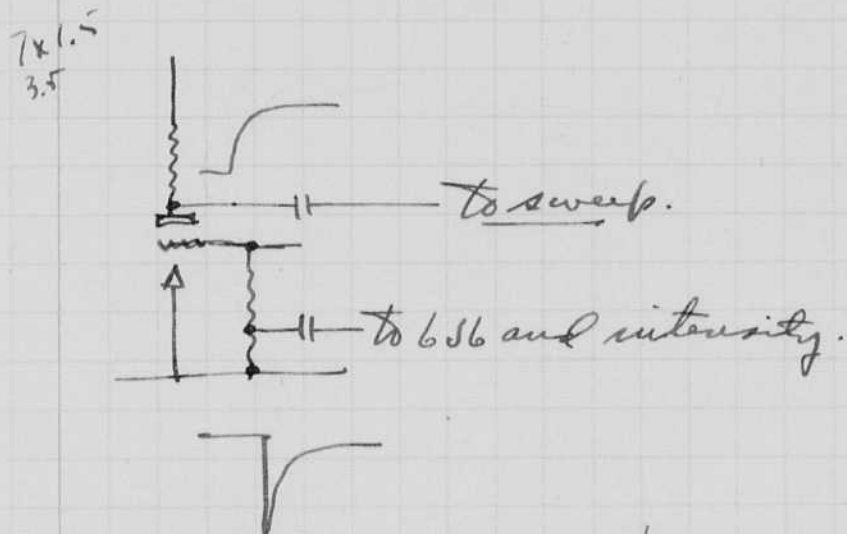
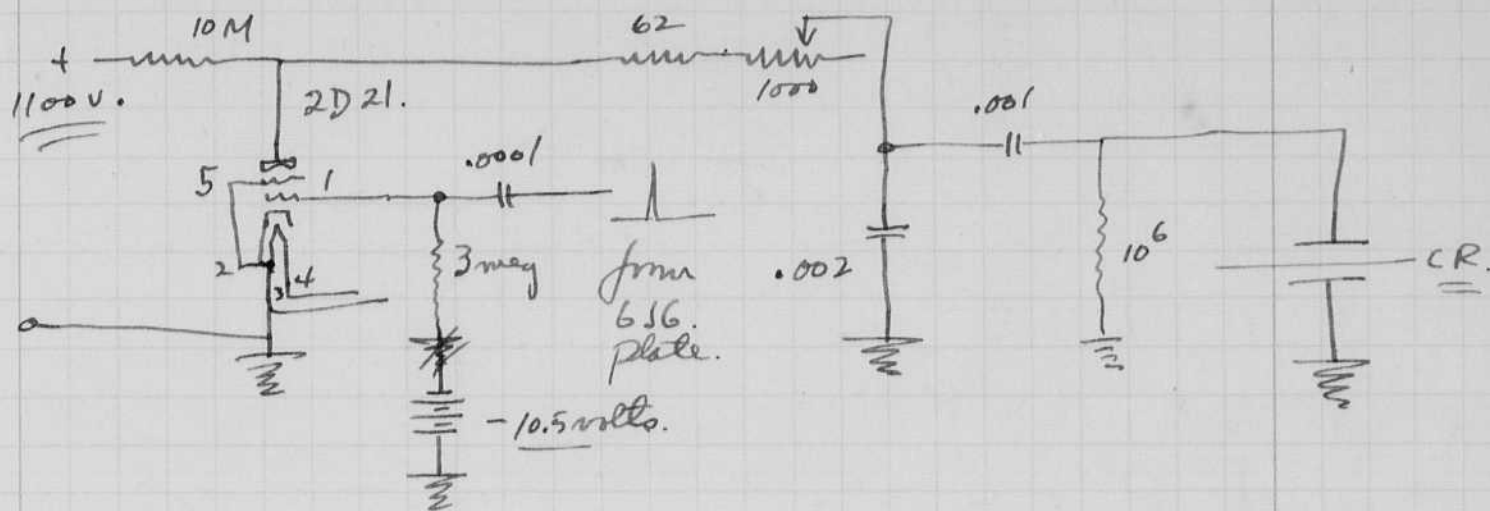

Scope shows that intensity is on first since a dot is shown.



Bias battery on 2D-21 changed from -10.5 to -4.5 (Sweep.) gave the sweep on the screen showing the start of the intensity.

After a few minutes the intensity came later.



Sweep voltage changed to 700 volts with -4.5 bias. Delay time is a function of bias and plate volts on 2D-21

12 Feb 10 1948

High Voltage Tunnel Column Hood Bldg.

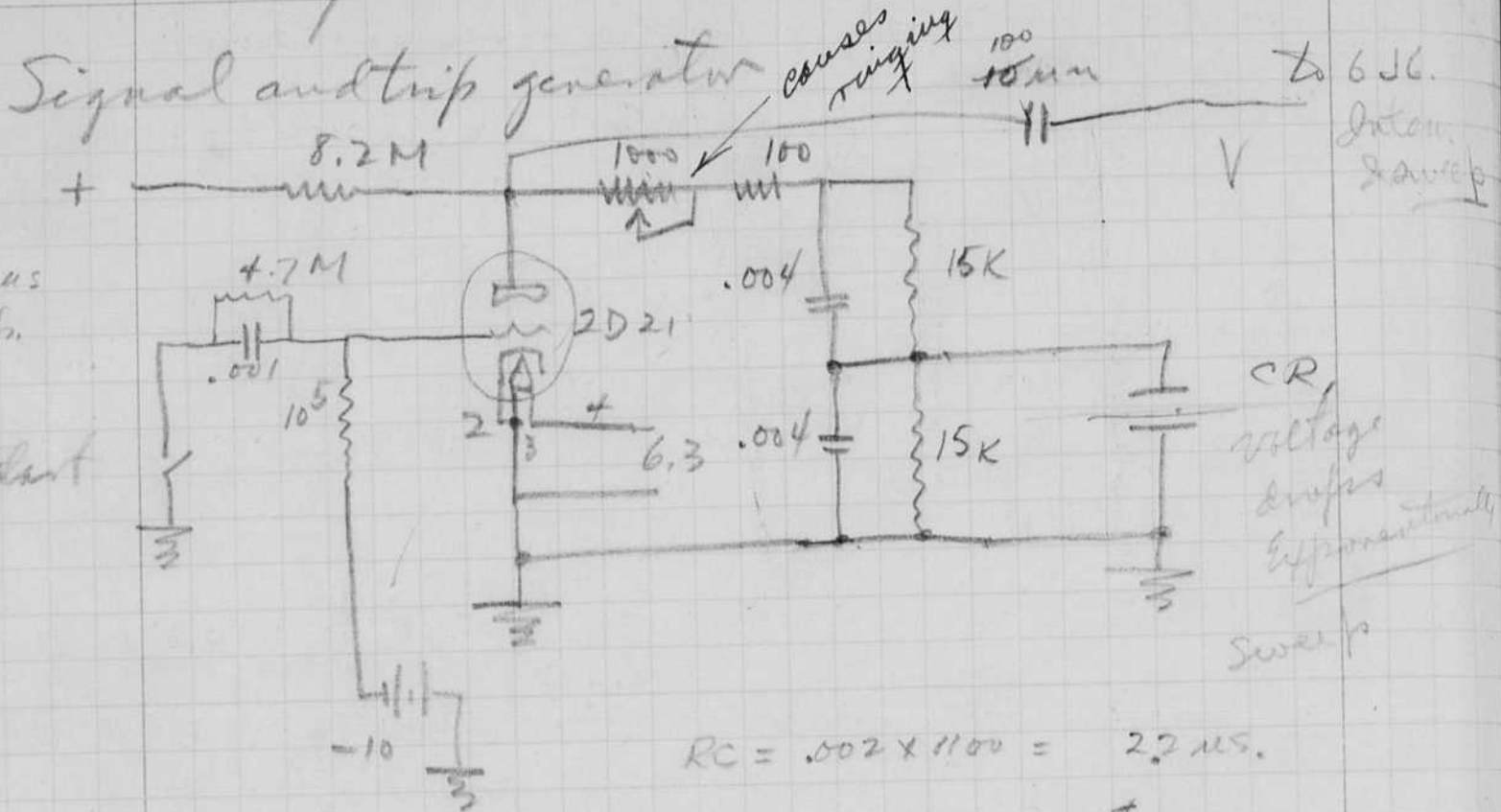

$RC = .002 \times 1100 = 2.2 \mu s.$

$E = E_0 e^{-t/RC}$
 $\frac{E}{E_0} = .8 = e^{-t/RC}$

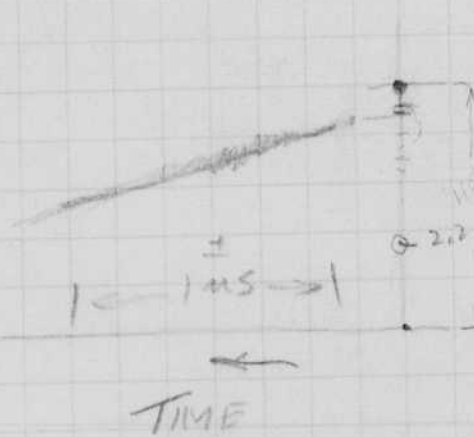

$E = .8$
 $t = ? \quad RC = \tau = \frac{1}{2.2}$
 $-\frac{t}{2.2} = \ln .8$
 $t = 2.2 \ln .8$
 $= .484$

t	E
0	1
.1	.9
.22	.8
.35	.7
.51	.6
.69	.5
.91	.4
1.2	.3
1.6	.2
2.3	.1

$2 \times 10^{-3} \times 8 \times 10^{-6} \times 10^{-6}$
 16×10^{-3}

$\frac{200 \times 10^{-12}}{10^{-7}}$
 $.002 \mu s$

The 6J6 (page 9) plate ^{supply} voltage was varied from 100 to 300 volts. The delay increased with ¹⁰⁰ τ of RC. With 300 volts the delay was smaller.

Increased plate resistance to 10K with 300 volts no appreciable improvement.

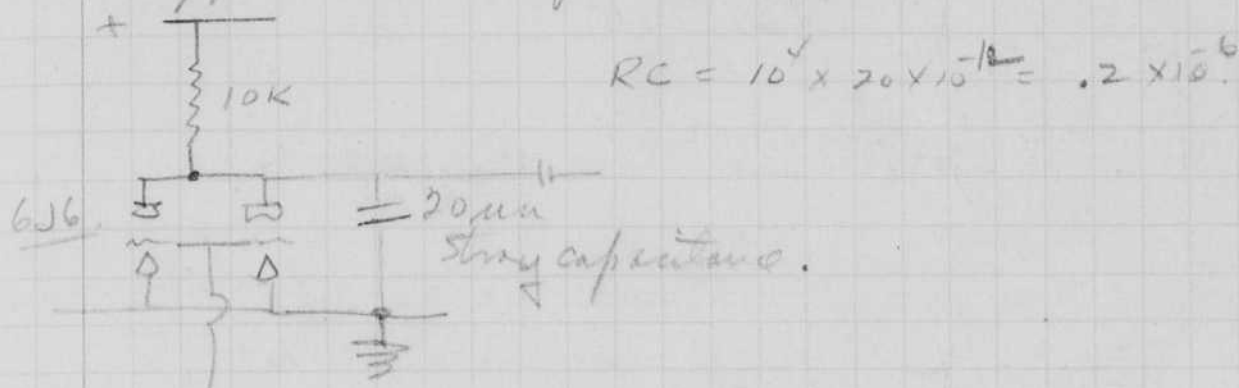

Feb 11, 1948. Conclusions of last night. The 6J6 and the 2D-21 give a delay of about .2 µs. Most of the delay is in the plate voltage rise of the 6J6.

Conf. with Eric, Fassel, Colson, Williams.

New circuit to try. 6J6 amp into cathode follower then to 2D-21 for intensity.

$C = 20 \mu F \times 20 \times 10^5 \Omega = 6 \times 10^{-6} \text{ sec} = .6 \mu \text{ sec}$

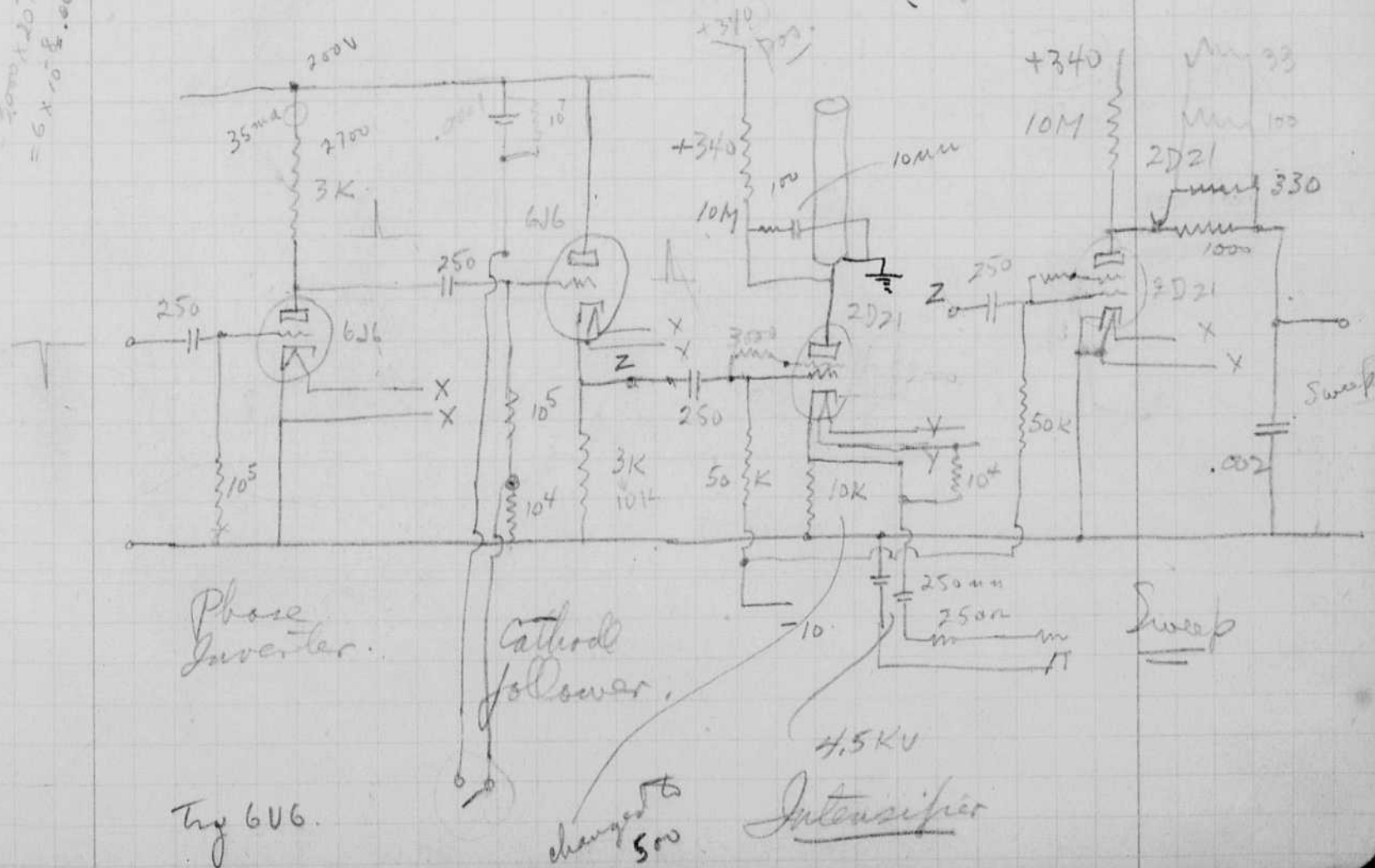

Trans 50+ ft of ~~RG 62/U~~ 13.5 na per ft.

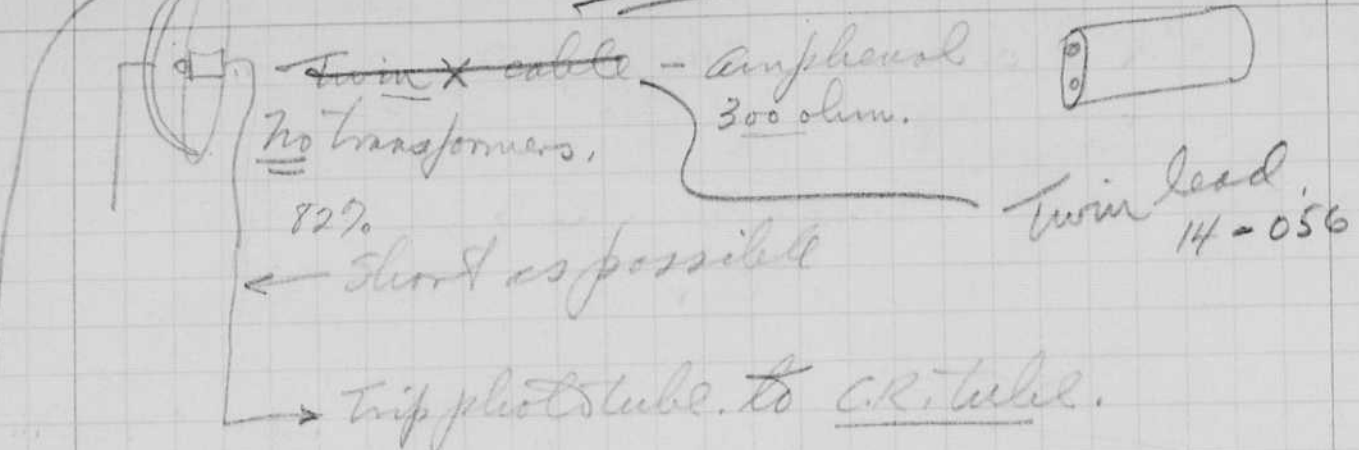

78% speed.
800 ft per μ s.

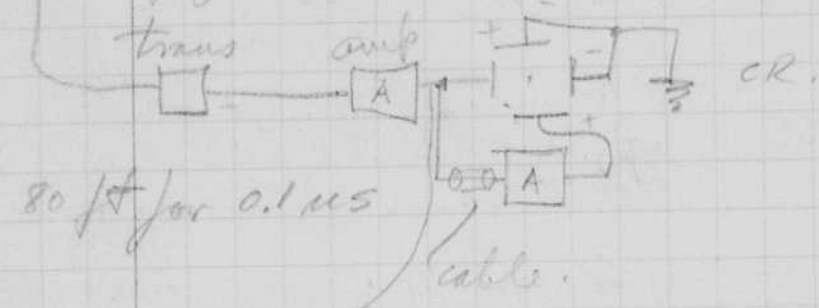

X calib.
270 volts. = $1 \frac{1}{32}$
200 volts/inch.

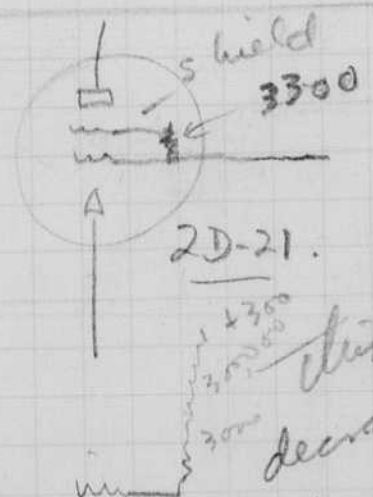
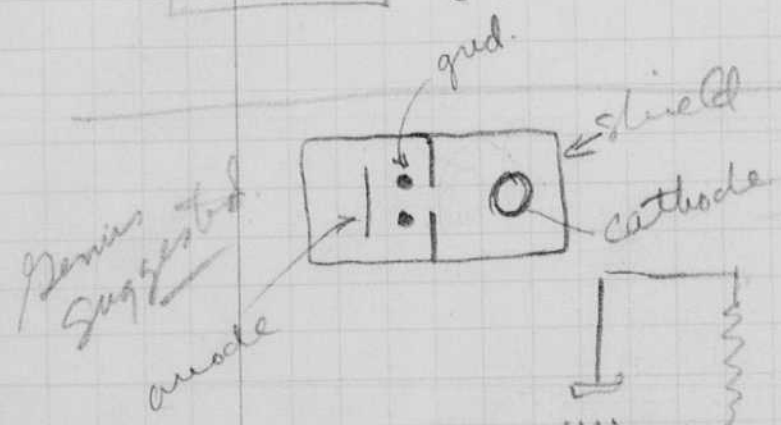
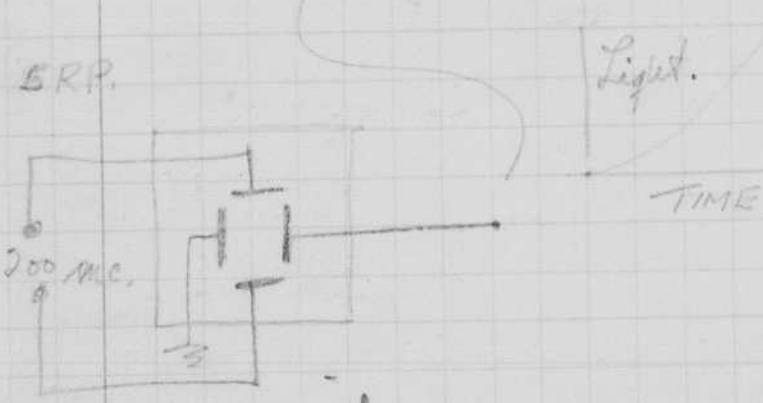

2D-21.
This connection decreases the time delay from 2 μ s to about .05 μ s.

$C = 10^{-11}$
25. 03

Feb 12 1948

BB Rogers & G. Colson.

Time delay of intensifier

Sweep (exponential) $RC = .002 \times 100 \times 10^6$ seconds.

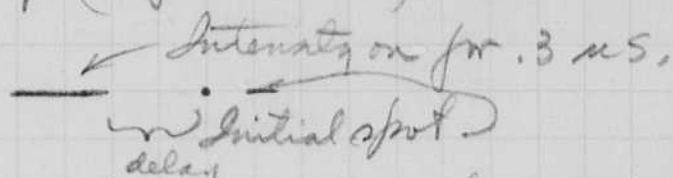

Bias adjustment on thyatron 2D21 has no effect on delay.

656 voltage varies the delay about 10% ±. The delay is smallest with 350+ volts on the 656 circuit

The screen grid of the 2D21 was connected + with 300 V and 300,000 ohms to see if this would decrease the time. No decrease

Resistance was decreased to 150,000. Same result.

We plan to use the other scheme.

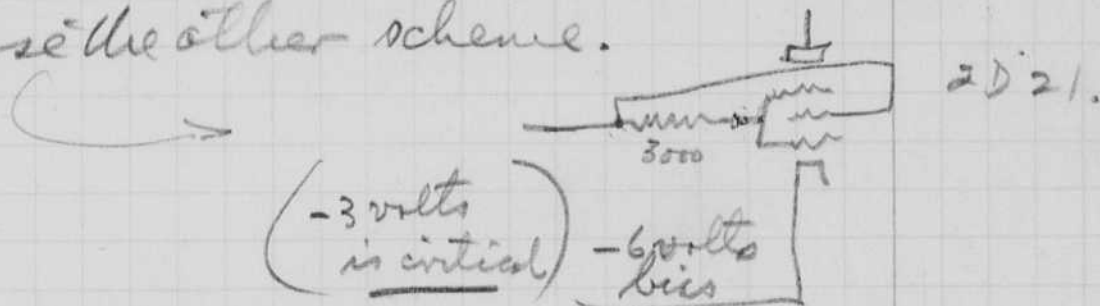

Estimated delay time is 0.2×10^{-6} μs.

Cathode follower 90 volts in $.8 \times 2 = .16$ μs.

Intensity thyatron fires in $.14$ μs.

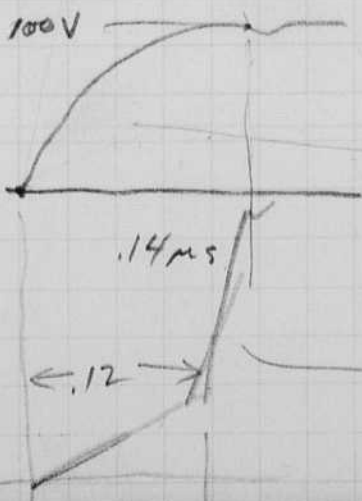

grid voltage of 2D21

no current?

cathode of 2D21

Plate voltage increased to 870 volts on 2D21.

Time delay slightly less $5 \times 2 = 0.1 \mu s$.

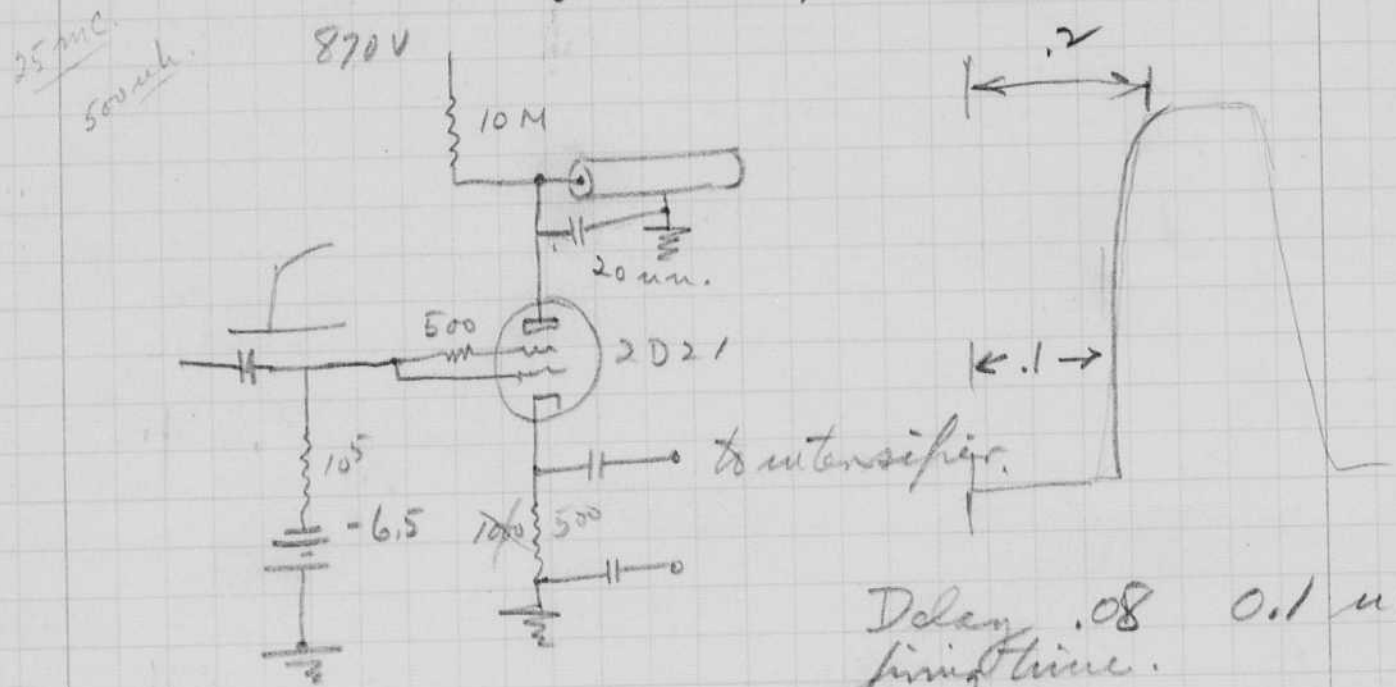

$RC = \frac{10 \times 10^{-6}}{10 \times 10^{-9}} = 10^{-1} = .101 \mu s$

20 nA - some hash on front of intensifier.
10 nA better. 10 nA with 100 ohms.

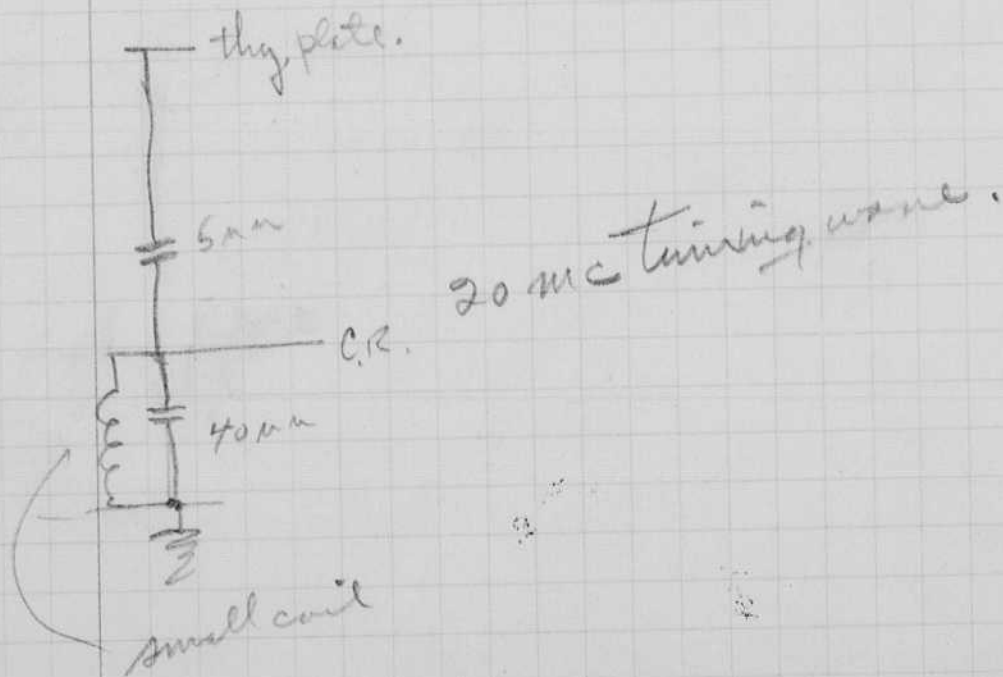

Feb 14 1948 Zier, Eberhard (Everett.)
 H.S. Egerton

100 ma from the photo multiplier.

807+
 4X150

f sq mc.	$\alpha \times 10^8$	$1/\alpha$	Z.	V_1 When P.C saturates	V_2	Gain.	V_3 out of 1st amp.	2nd Limit	Time reducn.	V_4	V_5
10	.5	2000	670	67	50	25	1200	A ₁	5	240	3000
20	1.	1000	500	50	35	10	350	A ₁	10	35	350
40	2.	500	330	33	20	3	60	all	20	3	9.

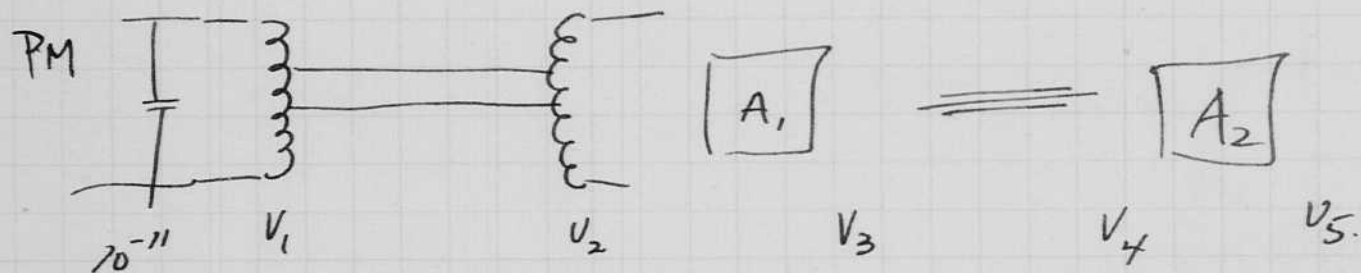

807 120 ma, 100 volts,
 4X150 60 ma, 720 volts.

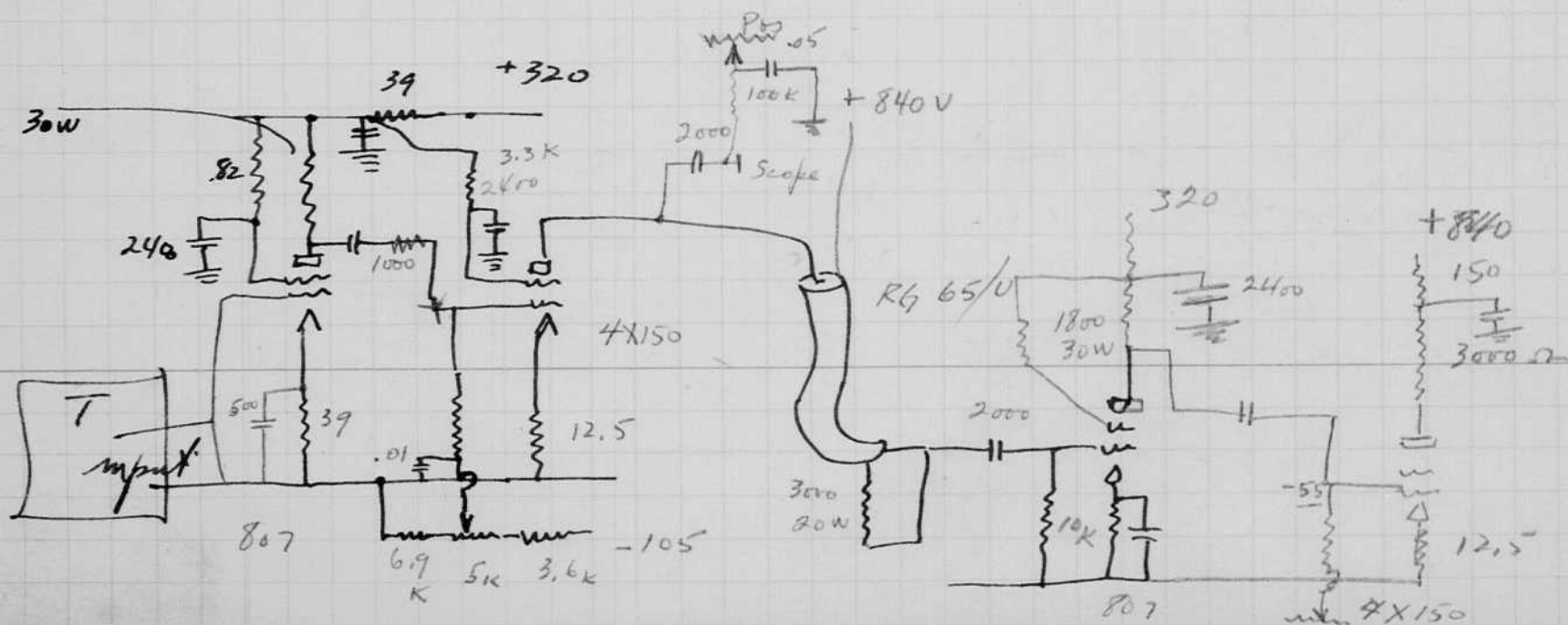

#5 G. S. G. S. G.
Feb 16 1948

Starting char of the 2D21 thyristor.

PR Synchroscope model 5 Serial 47.

Trigger output 3.3" in .4 or .5 inch

2.370
+161.5 volts

2.3" x 70
+161V

x 40 volts.
731 volts peak.
1" = 1.012 μ s.
pos #3. sweep.
Rise time \approx .5 μ s.

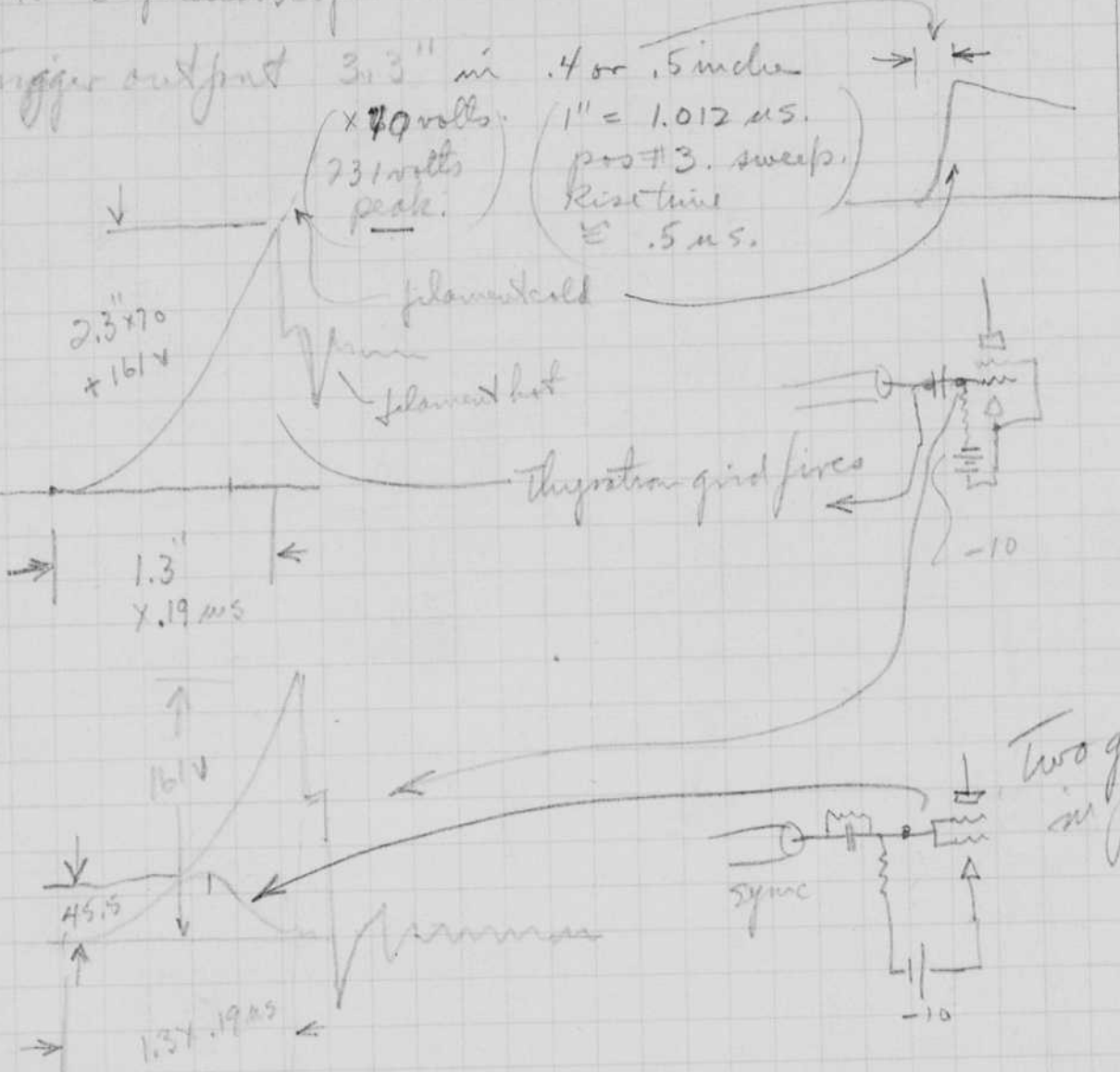

with plate supply connected.

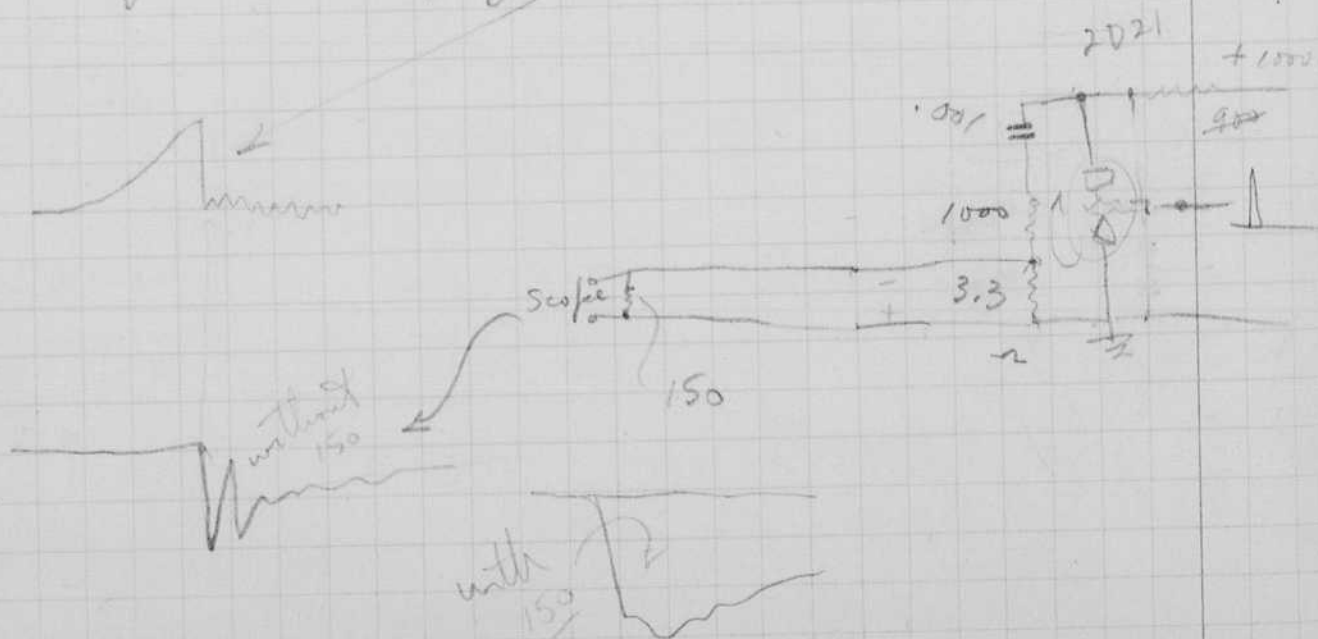

Synchroscope Model 5 Serial 47.

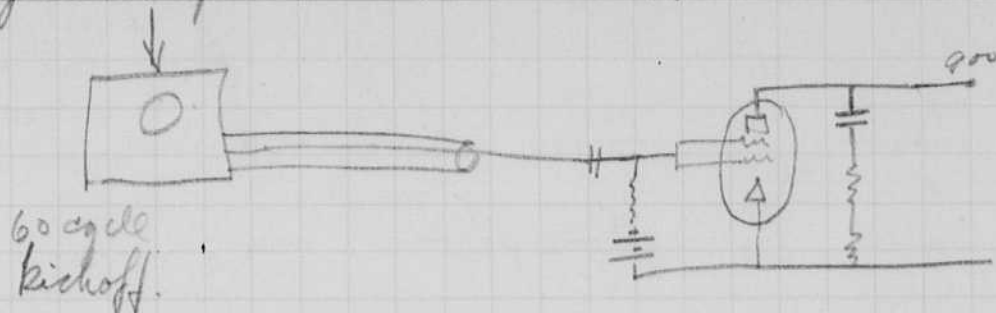

Feb. 18, 1948. Edg & Jussel. Freq-gain curve of photo cell to CR table links

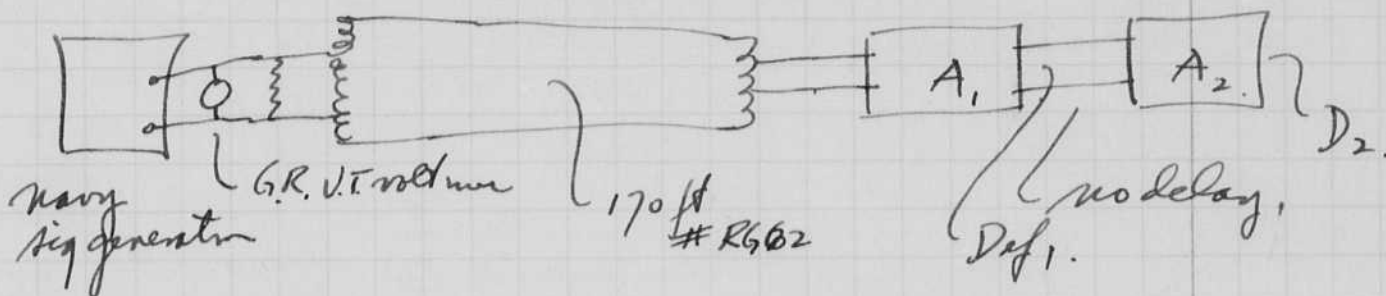

f mc.	Volts input.	Vs	Is.	Ip.	D ₁ mm.	D ₂ mm	peak to peak on CR table
20	.3	320	60			3.	10
10	.25	320	60			6.	24
5	1.00	320	60		2.7	51.	51
8.	.8	320	232	78	1.1	17.	21
9.5	.7	320	232		1.1	5	7.
20	1.	320			0.	2.	2.
15.							
12.	1.5V	320	232	60-65	1.	8.	53
14.5	1.35V.	320	232	58.	-	4.6	34
16.	1.0	320	232			2.5	25 KV on. 25
16	1.0	320	232			6.0	6.0 4KV only on scope.
20	0.45	320	232			3.	6.6
24	.33	320	232	58.		3.3	10.0

Relative gain

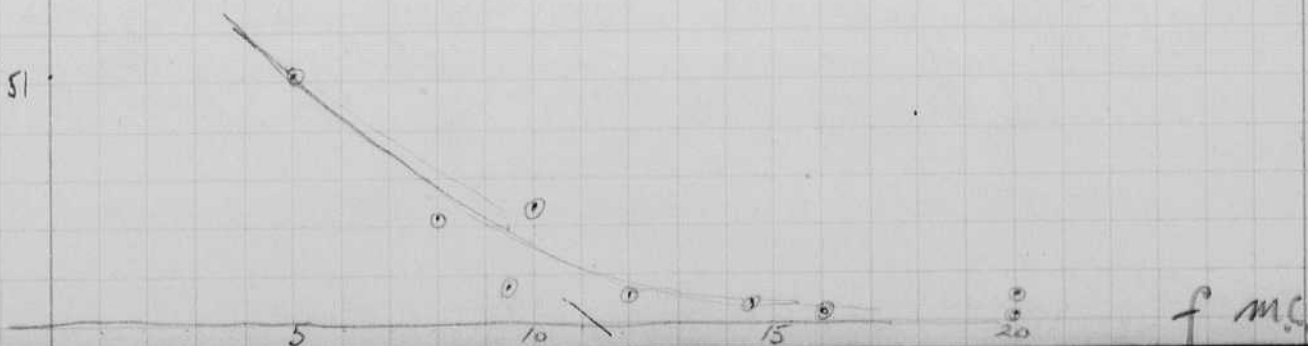

20 Feb. 1948
 H.S. Edgerton
 Low Fessel

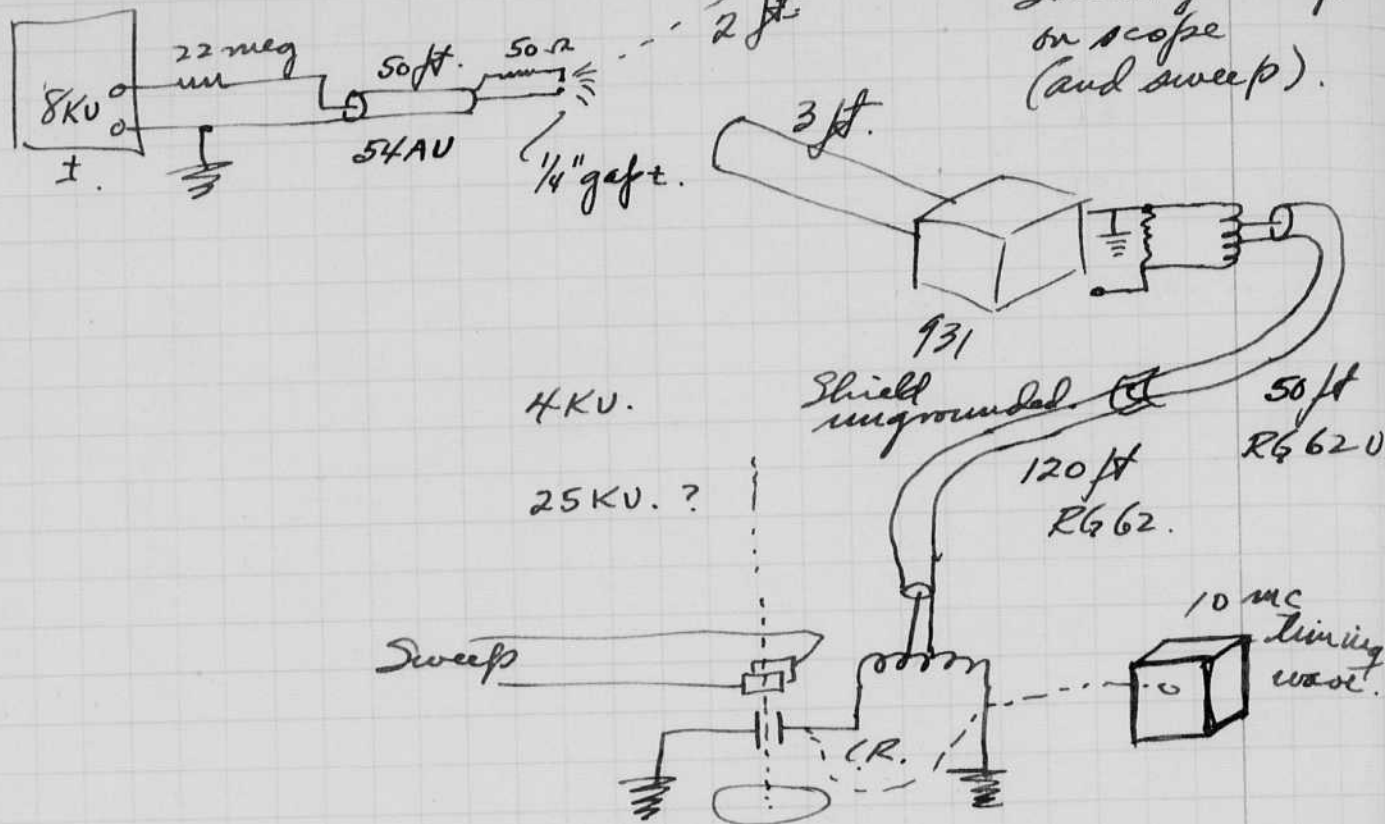

Film no.
 2019

as above. Two sparks recorded on same film.
 Two timing waves recorded.

2020. Spark gap from .0012 at $4400 \times \sqrt{2}$ volts.
 1. Light trace.
 1. Zero trace
 1. Offset 10 mc timing trace.

2021 (5) 1st stage 807 to scope plate. See part
 same as 2020.
 10 mc timing.
 2 zero traces with D.C. Photo mult off.
 (Some pickup).

2022 (18) 807 + 4X150 full volts 70 ma. 300V screen
 Ditto gap. 4 exposures with y axis shifted.
 Pickup only with P.17. circuit off.

2023 (17) 807 + 4X150 full power as above. One trace and zero
 Spark gap ditto.
 Trace of input to 807 (with 807 out of socket).

Feb 20 1948
A.C. Eq.

21

2024. film

Spark source .0012 mf at 6000 V ±

1. P.M. trans-line-trans plus amp. two stages.
2. Zero trace.
3. Signal direct from P.M.-trans-line-trans.
4. ~~open~~ zero trace.

22 Feb 20 1945
 S.E. Ogston

935 phototube tests. 44 v/pinch

	v.	ma.	Lumens
tube no 14.	500	39.5	2240
	1000	79	2240
	1500	110	2240
	2000	132	2240
no 13	500	48.4	2240
	1000	92.5	"
	1500	123	"
	2000	150	"
	2200	163	"
Burnt Base	500	9	"
	1000	83.7	"
	1500	145	"
"	1000	53	560
	2000	70	560
"	1000	17.6	140
	2000	17.6	140
	500	13.2	140

Light 10.5mf 2100 v.
 FT-14 no 111 18" from
 photo cell. No reflector.

Peak lumens 9×10^6
 $.9 \times 10^6$ h.c.p.s.

$$U = \frac{.9 \times 10^6}{1.5^2} = .4 \text{ lumens/sq ft.}$$

$$\text{cell area} = 1\frac{5}{16} \times 5/8 = 0.82 \text{ sq. in.}$$

$$= .0056 \text{ sq ft.}$$

$$\text{Peak Light on cell} = .4 \times 10^6 \times .0056 = 2240 \text{ lumens.}$$

With Distance = 36" = 3'

$$\text{Peak light} = \frac{2240}{4} = 560 \text{ lumens}$$

$$\text{with Distance} = 72" = 6 \text{ ft } 5?$$

$$\text{Peak light} = \frac{2280}{16} = 140 \text{ lumens}$$

Photocell
 current in ma



Rated output is
 about 70 ma/lumen
 with 2880°K
 light. Increase
 is due to color
 temp of Xenon

$$\frac{17.6 \text{ ma}}{140} = 125 \frac{\text{ma}}{\text{lumen}}$$

See page 21

Light

10 mic
timing wave

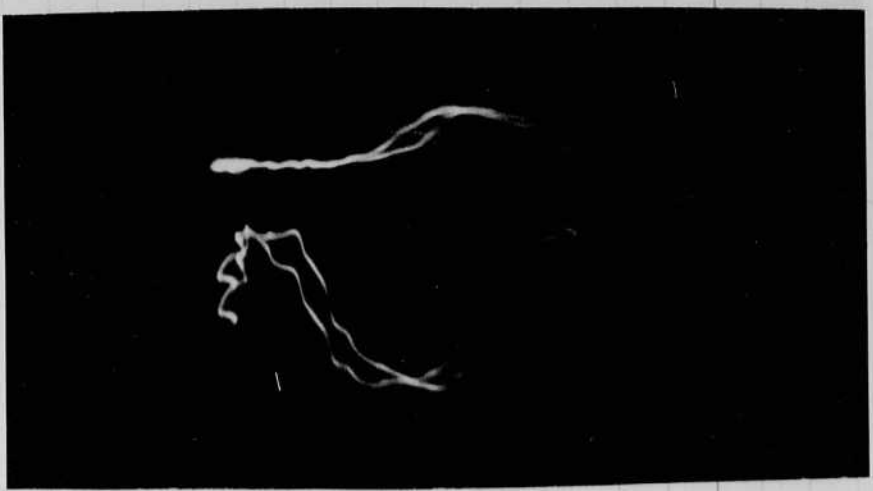

2019

Spark.

amplifier
output.

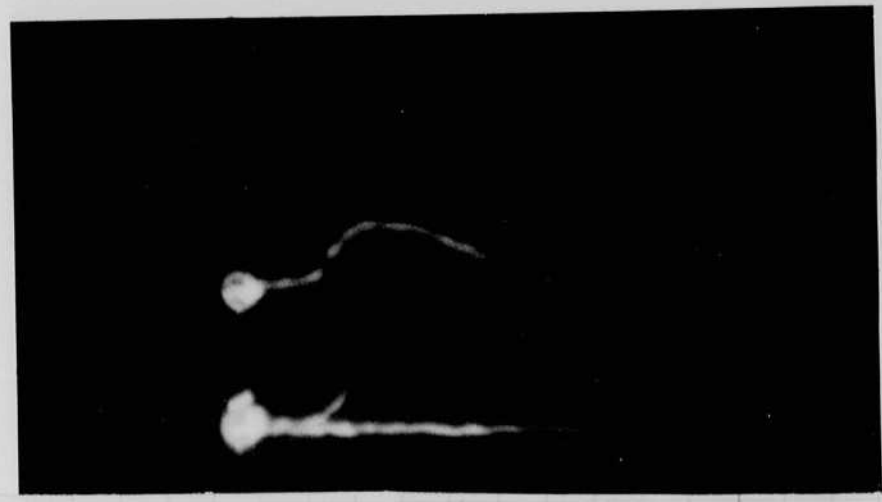

2022

Spark.

amplifier
output.

two records.

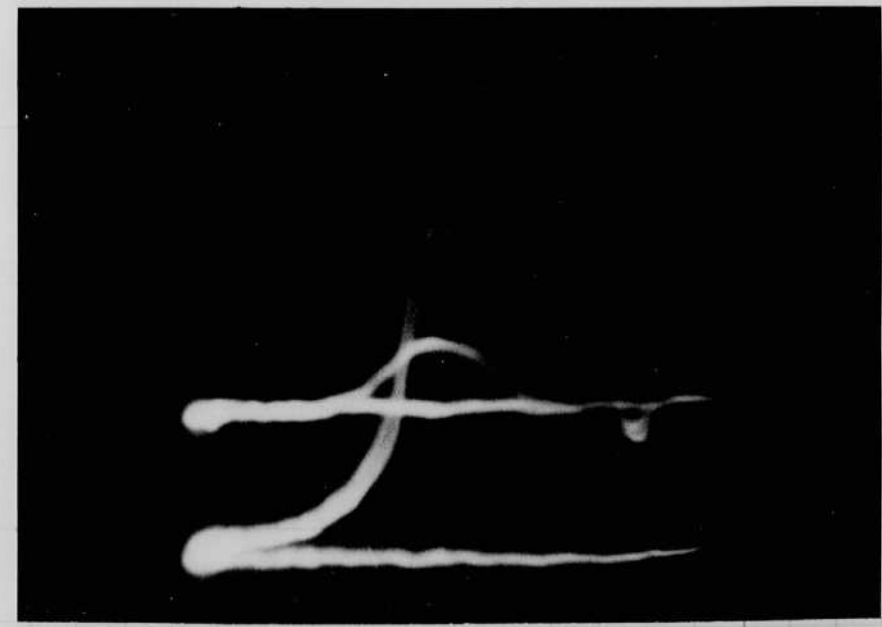

2024

25
LA/
Sum

22 Feb 20 1945
S.E. Ogerton

935 phototube tests. 440/μm

Tube No	V.	ma.	Lumens	Light	Notes
no 14.	500	39.5	2240	10.5 mf	2100 v.
	1000	74	2240	FT-14 no 111	18" from
	1500	110	2240	photo cell.	No reflector.
	2000	132	2240		

no 13	V.	ma.	Lumens	Notes
500	48.4	2240	Peak lumens	9×10^6
1000	92.5	"		$.9 \times 10^6$ h.c.p.s.
1500	123	"		
2000	150	"		
2200	163	"		

$$U = \frac{.9 \times 10^6}{1.5^2} = .4 \text{ lumens/sq ft.}$$

Brand	V.	ma.	Lumens
Bunt Base	500	7	"
	1000	83.7	"
	1500	145	"
"	1000	53	560
	2000	70	560
"	1000	17.6	140
	2000	17.6	140
	500	13.2	140

$$\text{cell area} = 1\frac{5}{16} \times \frac{5}{8} = 0.82 \text{ sq. in.}$$

$$= .0056 \text{ sq ft.}$$

$$\text{Peak Light on cell} = .4 \times 10^6 \times .0056 = 2240 \text{ lumens.}$$

With Distance = 36" = 3'

$$\text{Peak light} = \frac{2240}{4} = 560 \text{ lumens}$$

with Distance = 72" = 6 ft

$$\text{Peak light} = \frac{2280}{16} = 140 \text{ lumens}$$

Rated output is about 70 μa/lumen with 2880°K light. Increase is due to color temp of Xenon

560 lumens

$$\frac{17.6 \text{ ma}}{140} = 125 \frac{\mu\text{a}}{\text{lumen}}$$

500 1000 1500 2000 Volts.

See page 21

Light

10 mc
timing wave

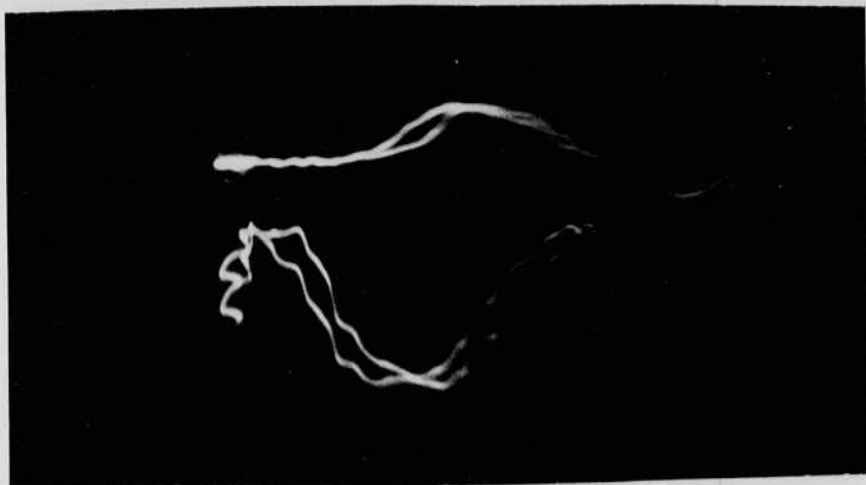

2019

Spark.

amplifier
output.

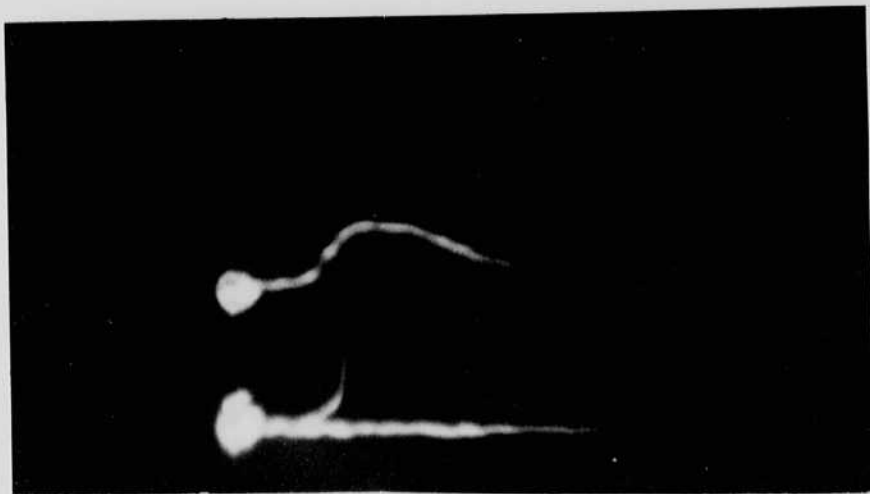

2022

Spark.

amplifier
output.

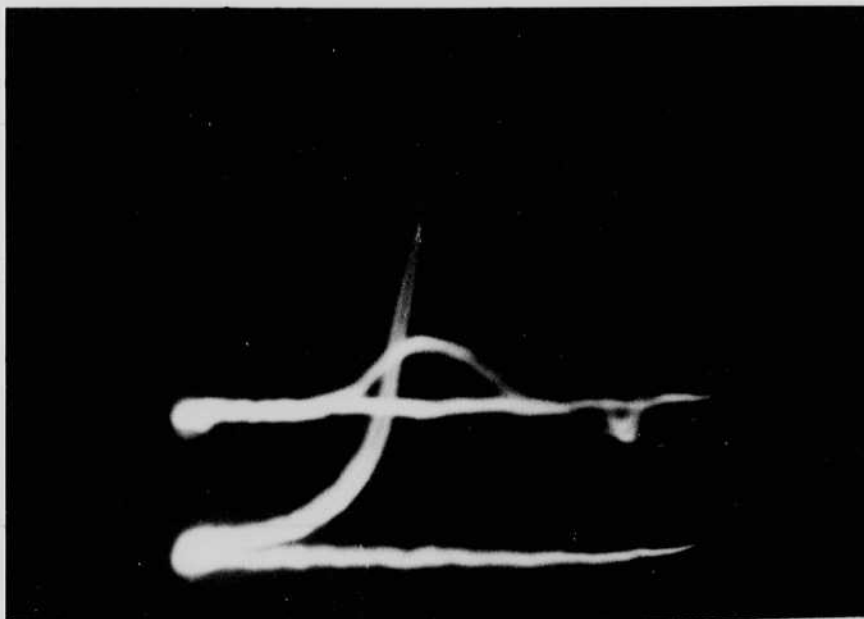

2024

two
records.

25
aa/
sum

24 A. S. Edgerton
Feb 21, 1948.

Calibration of G.R. Light meters with Borstow
Mac Roberts and Al Webb of G.R. 69mf 2400 volts
on an FT-14 was used. Meter about 2.4 ft
from lamp in a velvet housing.

$$\begin{aligned}\text{Velocity of light} &= 186,000 \text{ miles/sec.} \\ &= 95.4 \text{ ft in } 0.1 \mu\text{s.}\end{aligned}$$

Data from Fassel, orig from Los Alamos.

P.M. tube gives 15,000 ampro at end of
active period from moth balls at the
P.M. tube at distance 12400 ft. ? yps.

With 935 sens is $1/10^6$ that of P.M.
current is then 15 ma.

with 104 ohms \rightarrow 150 volts out put.
10⁵ " \rightarrow 15 volts out put.

Sensitivity of 935 Phototube.

#2	19.7 ma
3	15.4
4	22
5	26.4
6	13.2

5 ft from 10.5 mf at 2000 v
1000 ohm

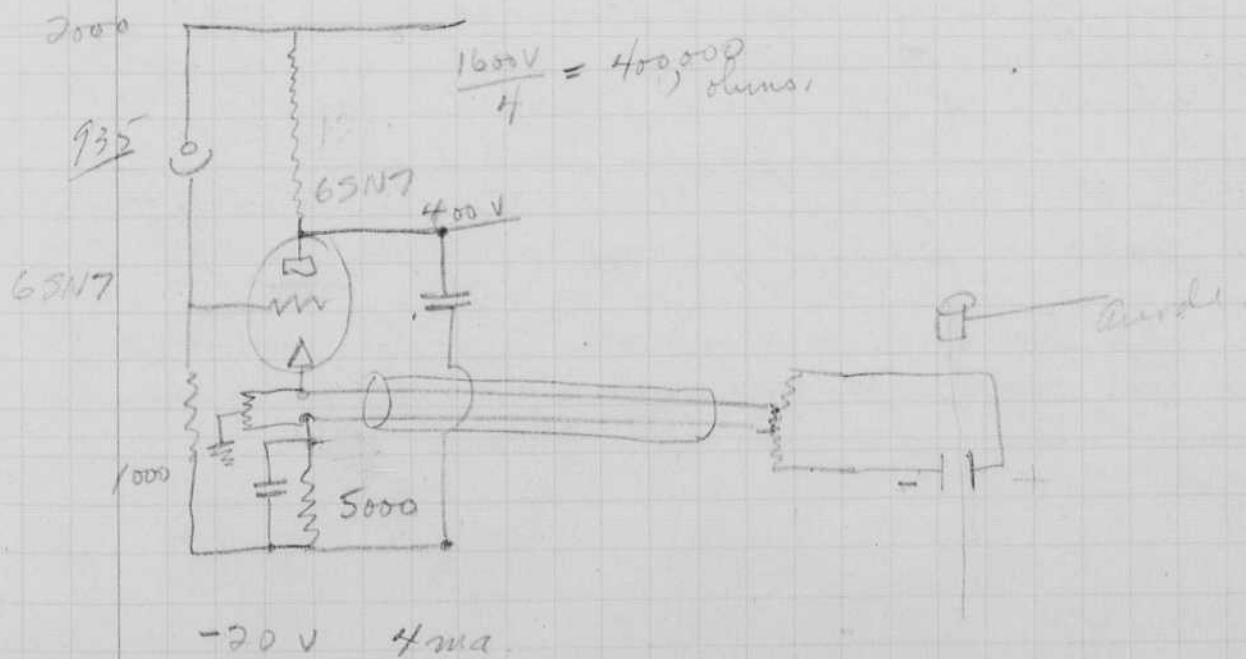
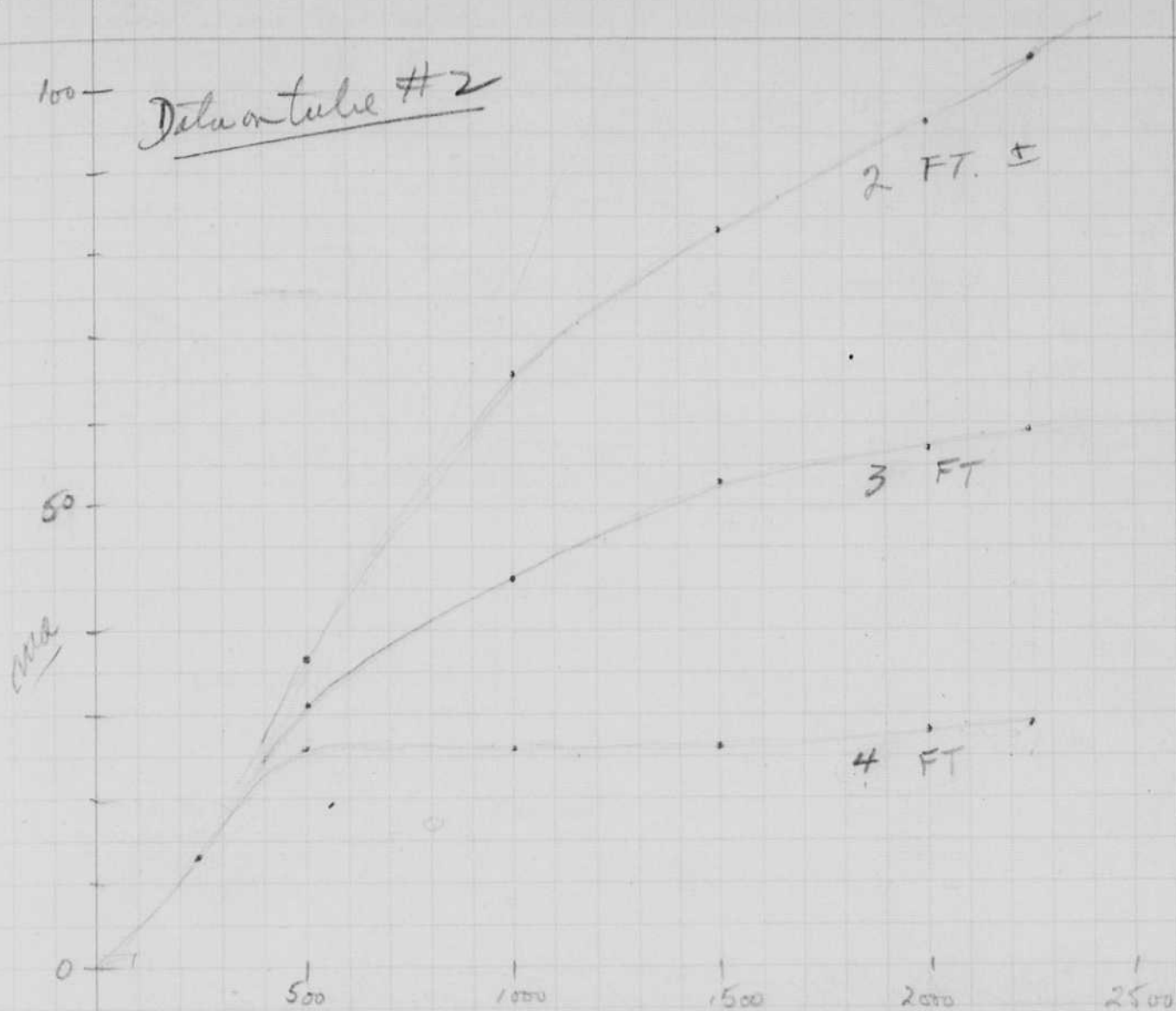

26 March 2 1948
 H. E. Edgerton Ed Colson
 Chas W. G. Hoff.

Photo Multiplier trip.

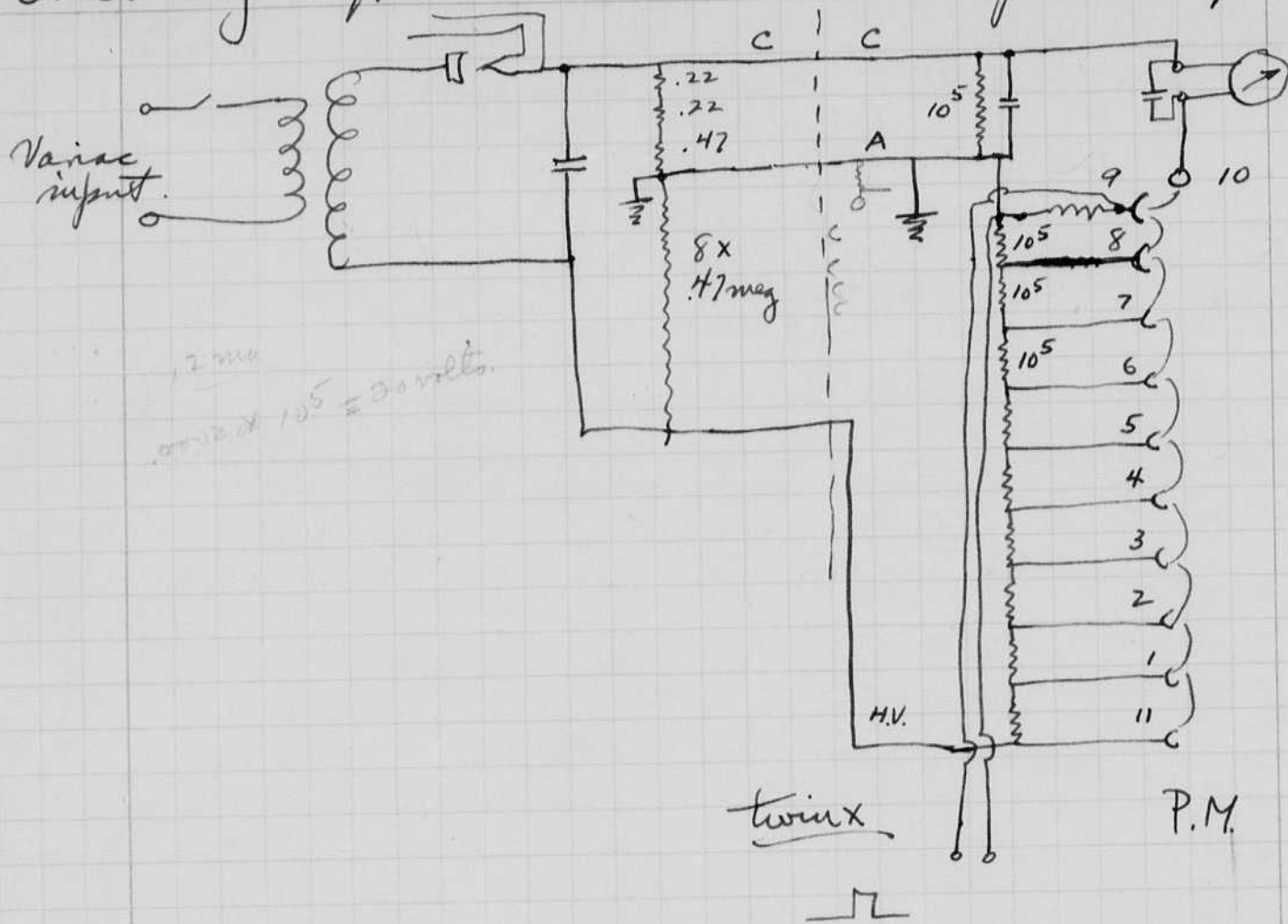

The output of this was put directly into the cathode follower stage on the scope intensifier and sweep.

The spark light source and photo multiplier source was then connected and the 150 ft of delay cable installed. The rise signal was not observed until the input to the photo multiplier trip power supply was increased to 125 volts.

The time delay is in the thyatrons. With the set up shown here the delay is about the same as that shown on page 13.

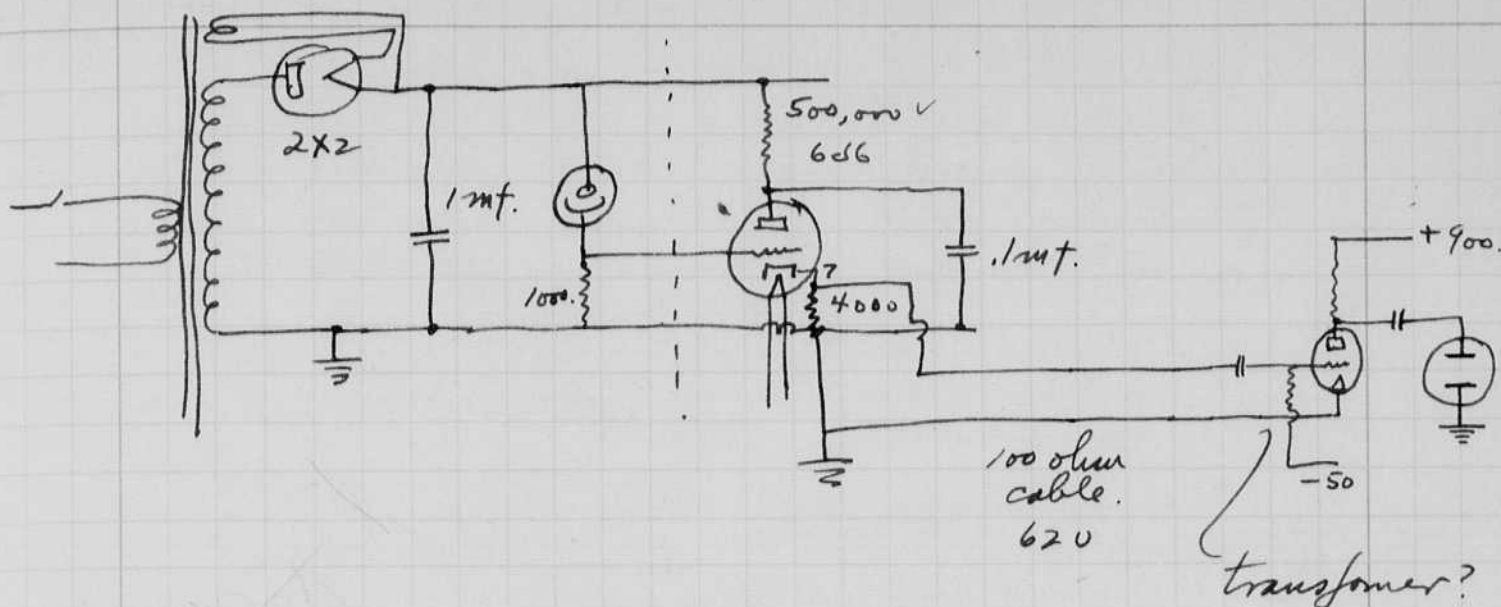

α	i_2/i_1 for 10^{-8} sec.
$.5 \times 10^8$	1.57
1.0	2.73
2.0	7.7

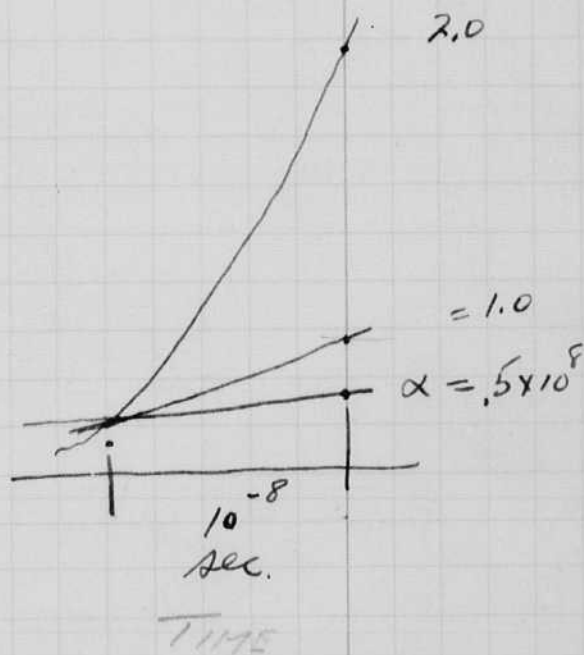

Log.
 Feb. 25 Wed left Boston 2:10 pm
 Feb. 29 Sat. arr. Los Angeles 11 am
 Mar. 1 Mon. Left Terminal Island. 9 am. on Albermarle AV5.

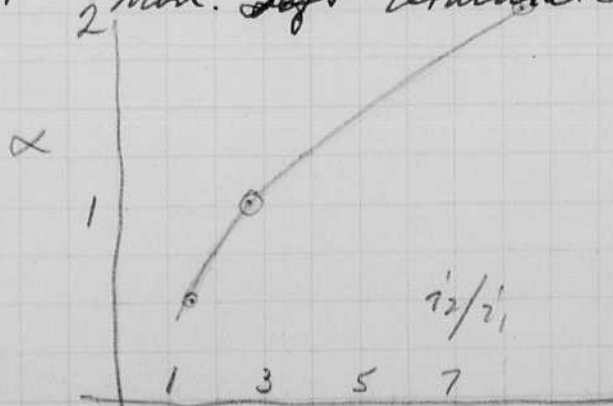

28 March 3 1948
 H. E. Eyring
 Eberhard.

Film no.

1.

Source spark gap. 4 or 5 KV into 0.1 m.f mica.
 Pickup. 931a positive surge as per page 26.
 into cathode follower or ~~photo~~ thyatron
 trans and
 RCA photo multiplier into 100+50 ft cable as used
 in Cambridge then into transformer and single
 ended into the scope.
 10 mc timing ~~usage~~ plus zero. both lower than
 light trace.
 - ground ends on transformer or scope connected
 together and grounded.

2.

Phototube 935

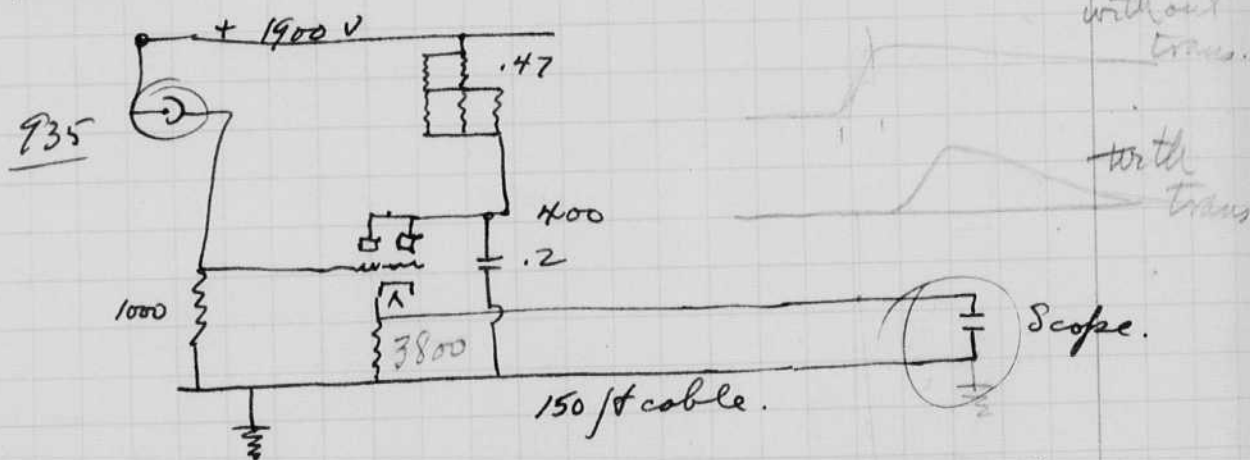

- A. Output of spark with P.C. 6 or 7 inches away.
 B. Zero.
 C. Axis moved 10 mc.
 D. Zero.

Mar 4 1948 Half way to Hawaii from Los Angeles
 Photomultiplier for trip.

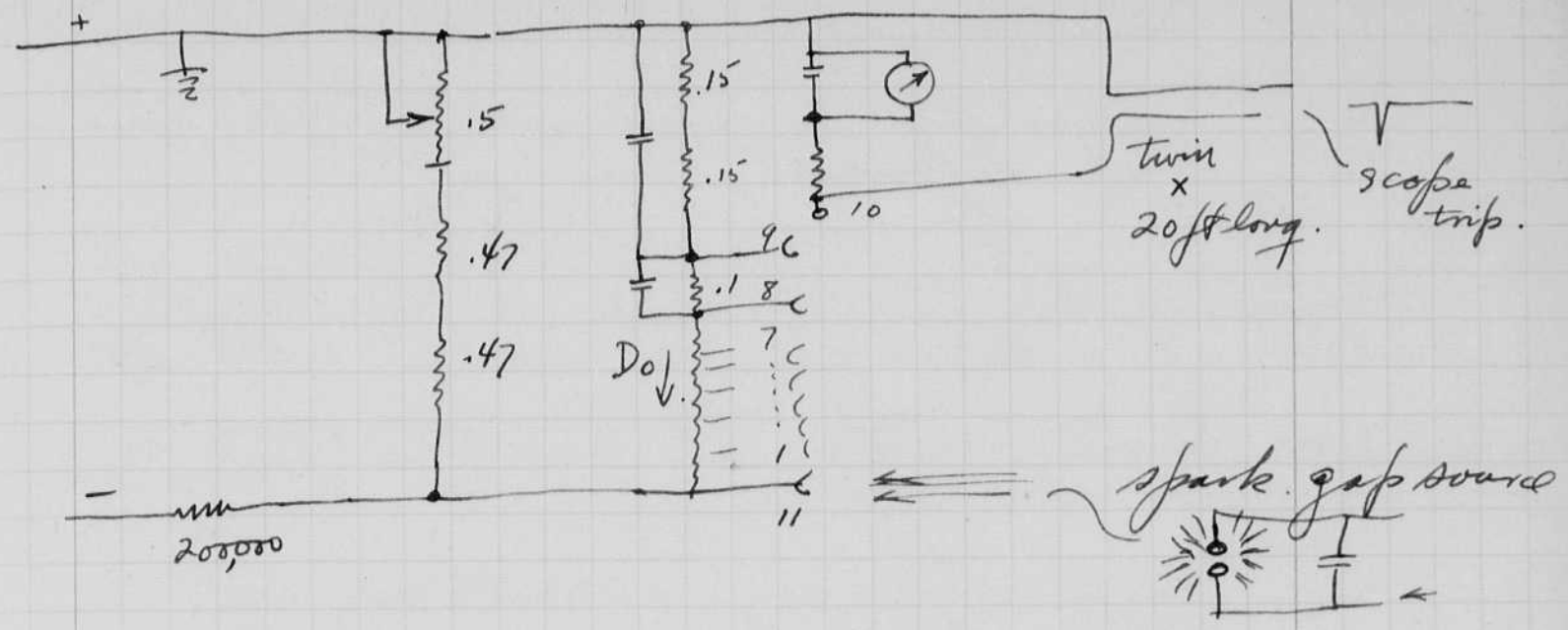

Film No.

3.

Spark 4.5" from 935 cathode.
 3.5 ft to neg ~~neg~~ P.M. trigger.

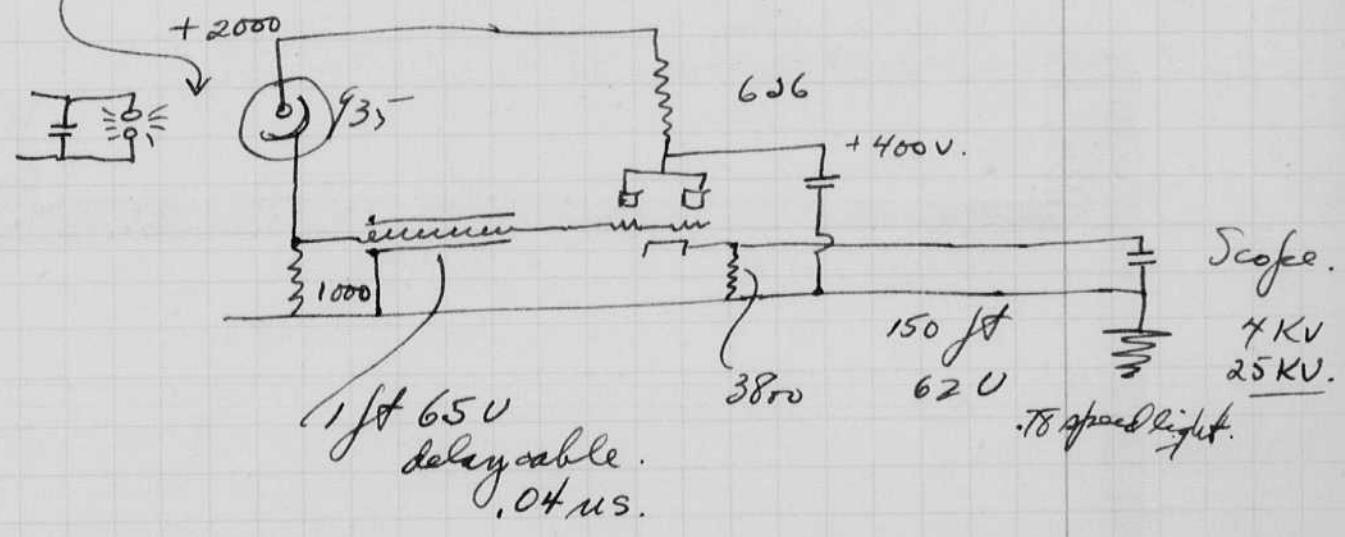

For trigger trip see above and circuit page 13.

Film No

4.

Same set up as 3 without 200 mc pickup.

Several sweeps made for comparison of different sparks.

5.

200 mc. timing wave. Several sweeps.

R = 34 ohms in parallel with ~~100~~ 100 and other values.

$$2.3 = 2 \text{ cycles.}$$

$$2.3 \text{ mm} = .01 \text{ seconds.}$$

6.

amp. 4 x 150 amp 45 ma Screen 360 V.

Input about same as 3 and 4.

7.

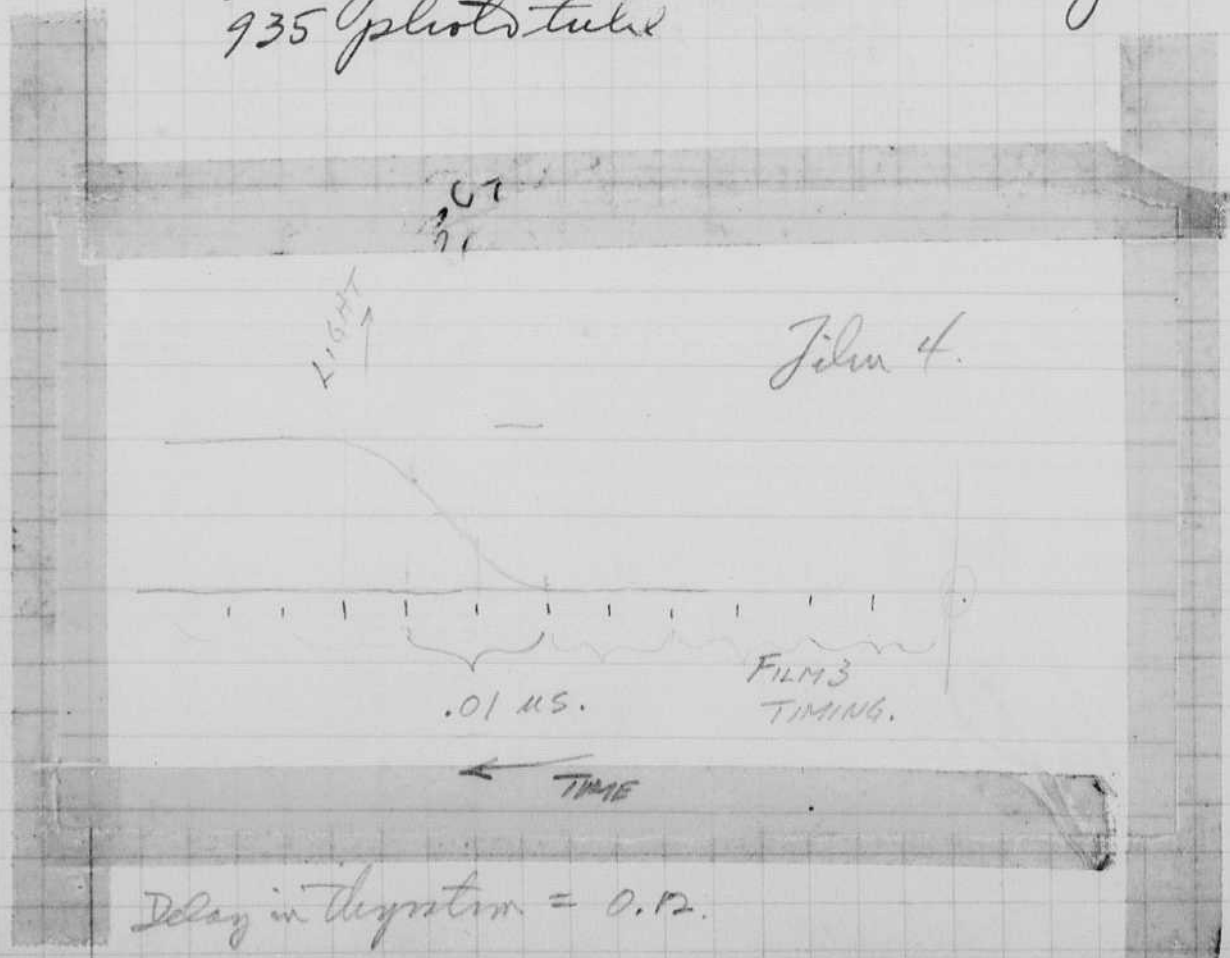
Two records made. One with the transformer and one without. The output ~~without the~~ with the transformer seems lower and there is some delay.The sparks was the same as photo No 3.
935 photo tube

Delay in the system = 0.12.

$$150 \times .78 = 118 \mu$$

$$186000 \text{ miles/sec.}$$

$$\frac{118}{10^6} = 985 \mu$$

$$\frac{118}{985} = .12 \mu s$$

additional .04 μs
between PC &
cath. follower
Total delay
= 0.16 μs.

Sweep speed
 $.2 \times 3 \text{ cm} = .01 \mu\text{s}$
 $23 \text{ cm} = 1 \mu\text{s}$

$10^4 \text{ per } \mu\text{s}$ on film

8

9

10 Calibration $.28 \text{ cm} = 70 \text{ volts}$. $\frac{70}{.28} = 250 \text{ volts per cm}$ or 25 volts/mm

- 11
1. Out put of spark into 935 - 170 ft 62^v ~~transformer~~ terminated in 1000 ohms. to scope plates .75V
 2. Ditto but terminated into 100 ohms. 100 ohms 20V should match 62 v cable.
 3. Zero for case 2 $\frac{2.1 \times}{2.3} = .01 - \mu\text{s}$. $\frac{2.1 \times}{2.3} = .0091 \mu\text{s}$.

- 12.
1. Out put of spark into 935 - 170 ft 62V cable transformer terminated into 1000 ohms. Scope measures input to transformer. $.6 \times 25 = 15V$
 2. Scope measures output of transformer. $1.1 \times 25 = 27.5V$
 3. Output on scope un terminated. $1.8 \times 25 = 45V$
 4. Out put of line to scope direct. $3.4 \times 25 = 85V$

Trans gain
 $= \frac{27.5}{15}$

- 13.
1. Ditto of shot 4 of film 12. Output of 935 and 170 ft of cable after cathode follower.
 2. Same as 1 but with Eimac grid load in parallel with scope plates on output of cable.

no large effect.
 some magnification?

Mar. 6, 1948

14. new photo multiplier circuit just finished by Ed Colson 4 X 150 amplifier tube as cathode follower. 150 ft of 62 v cable then 4 X 150 amplifier with 3000 ohms to scope.

15. ~~Input~~ Output of cable as per 14 with second 4 X 150 disconnected. (Small signal). Repeat with more light on P.D. tube. $\text{Sat} = 5.2 \times 25 = 130V$

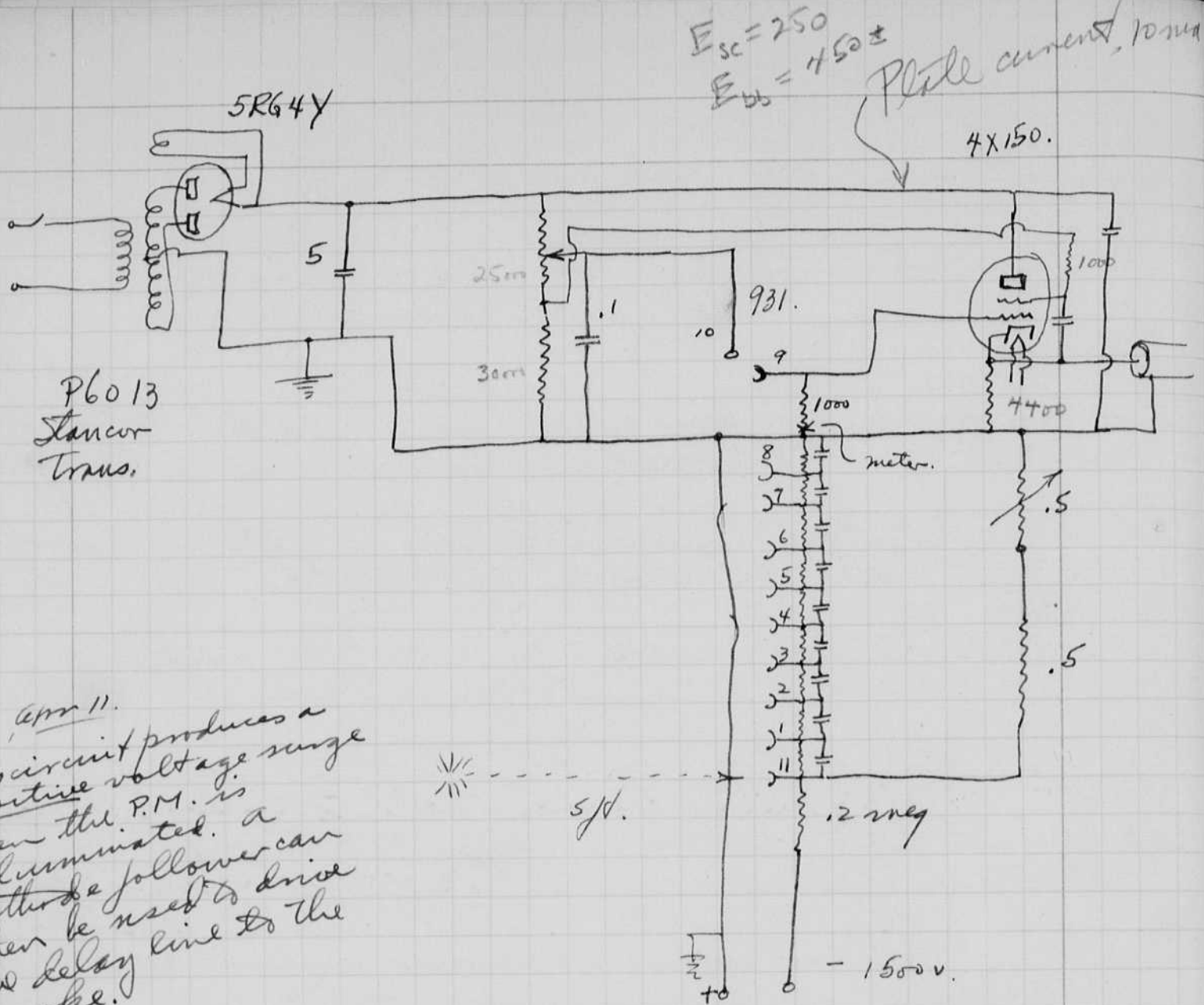

Note. Apr 11.
This circuit produces a positive voltage surge when the P.M. is illuminated. a cathode follower can then be used to drive the delay line to the scope.

Film 16. $5.7 \times 25 = 12.5V$.
931 - 4X150 cathode follower to 150' cable to scope

49425
122 ✓ 935 - " " " " " " " " " " " "

Delay = $\left\{ \begin{array}{l} 5. \times .0091 = .046 \mu s \\ 2.5 \end{array} \right.$
The 935 phototube has less delay and a steeper rise according to a look.
The 935 was 1/10 the distance of 931.

note
a piece of glass was used as a filter for the 935 to cut out the U.V. there was a 60% reduction in amplitude but the form and starting time of the image was the same as without the glass.

1 layout of Hawaii on albatross. AV5.
Mar. 6, 1948.

Grier
Eberhard
Colson
Wydroff
Edgerlin.

LIGHT.

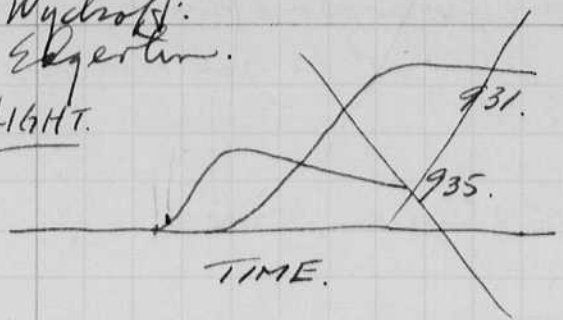

Visual observation.

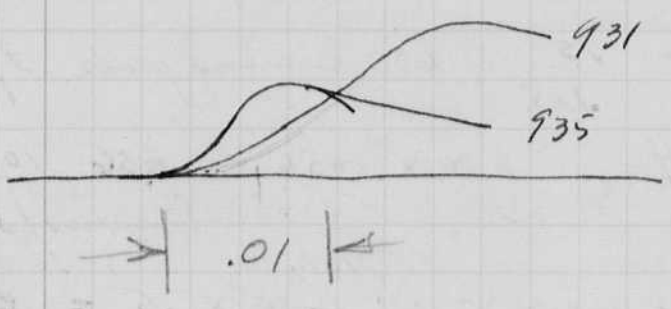

Visual observation.

1000 ft per us.

.005 = 5 ft.

Film 17. Spark light output measured by 935 into Eimac 4X150 tube (C.F.) ^{170'} 150' cable to scope.
The output appears to be about double that of the 935 and 6V6 combination.

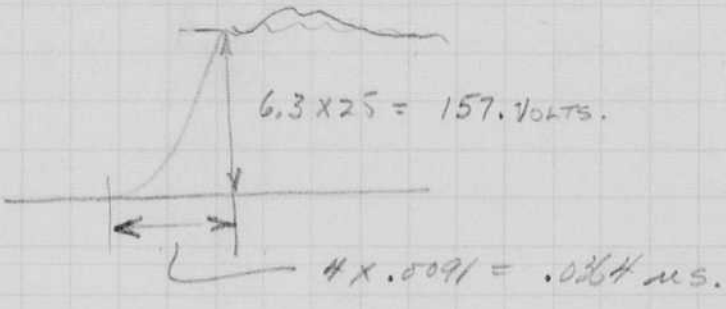

Film 18 Spark light output.

- ① 935 into Eimac 4X150 (CF) 170' 6" cable to scope same as Film No 17.
- ② Ditto 1 except a 4X150 used as amplifier between cable and scope.
Plate load = 3500 ohms

March 8, 1948. Pearl Harbor
H. E. Edgerton Oahu

off ship yesterday at noon for a three hour tour of the island. Then had supper at Royal Hawaiian Hotel and saw concert..

935 photod Light output. $\frac{75V}{1000} = 0.075 \text{ amp} = 75 \text{ ma.}$

125 ma per lumen

lumens = $\frac{75}{.125} = 600 \text{ lumens peak at p.c.}$

$600 \times 0.0056 = 3.36 \text{ lumens/sq ft.}$

Source candle power = $3.36 \times .5 = 1.68 \text{ CP}$

935 driving 4X150 cathode follower 170' cable (62V) to scope.
1000 ohm load resistor.

CR. deflection .1" .45 .15 .95 1.2

935-Sf distance 4" 6" 10" 4" 3"

d^2	16	36	100	16	9
$1/d^2$.0625	.278	1	.0625	.111
	6.25	2.78	1	6.25	11.1

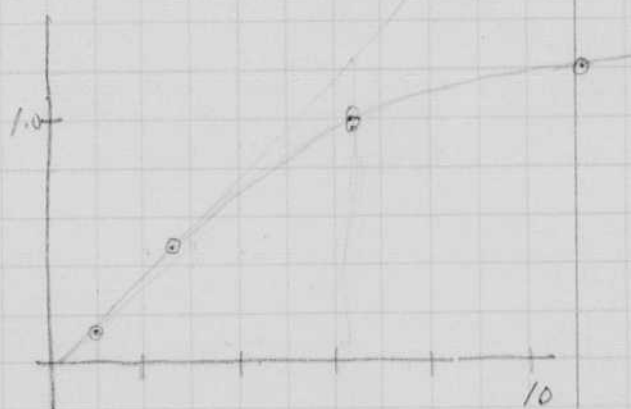

$10^3 \times 8 \times 10^{12} = 10^{-8} \text{ sec}$

931 photomultiplier + surge 1000ohms anode g
4X150 PM tube and 150 ft of 62V cable.

distance to light = 21'
a curtain over the light reduced the light to about 1/25 th or less.

deflection on scope about 1/2 inch.

Mar. 9, 1948
 David Edgerton. Mike Eberhard.
 1 ~~Foot~~ Day out of Hawaii west

P.M.	Rating.
28	6.6
28	17.7
52	24
76	51.7

Further visual tests of photo multiplier tubes. The light output from the spark source was measured with the scope and sweep circuit. All p m tubes showed the same type of output signal. There seems to be a delay. Change of final anode voltage from 330 to 440 makes no appreciable difference in the final saturation current.

9.30 abandon ship drill

10.00 conference on method of meas of α .

Film no 19. 270 ohms and 1000 ohms.

Spark source now has double the capacity it previously had.

$$C = .008 \times 4 = .032$$

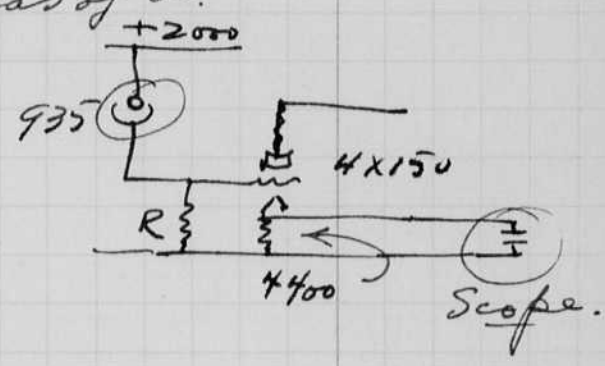

Method of obtaining extra voltage is to use another cathode follower and open ended line. This was discussed at length with Grier and Eberhard. The gain will be less than 2 for each combination of C.F. and line.

Mar 9 1948
Harold E. Eberhard.

935 tube tests.

TUBE No. 6. 12 3 1 2 9 [✓] E5 [✓] E2 7 8 E3 [✓] 10 11 5 4.

DEF. IN" .4 .56 .3 .55 .45 .45 .25 .2 .25+ .5 2- .3 .4 .45 .3

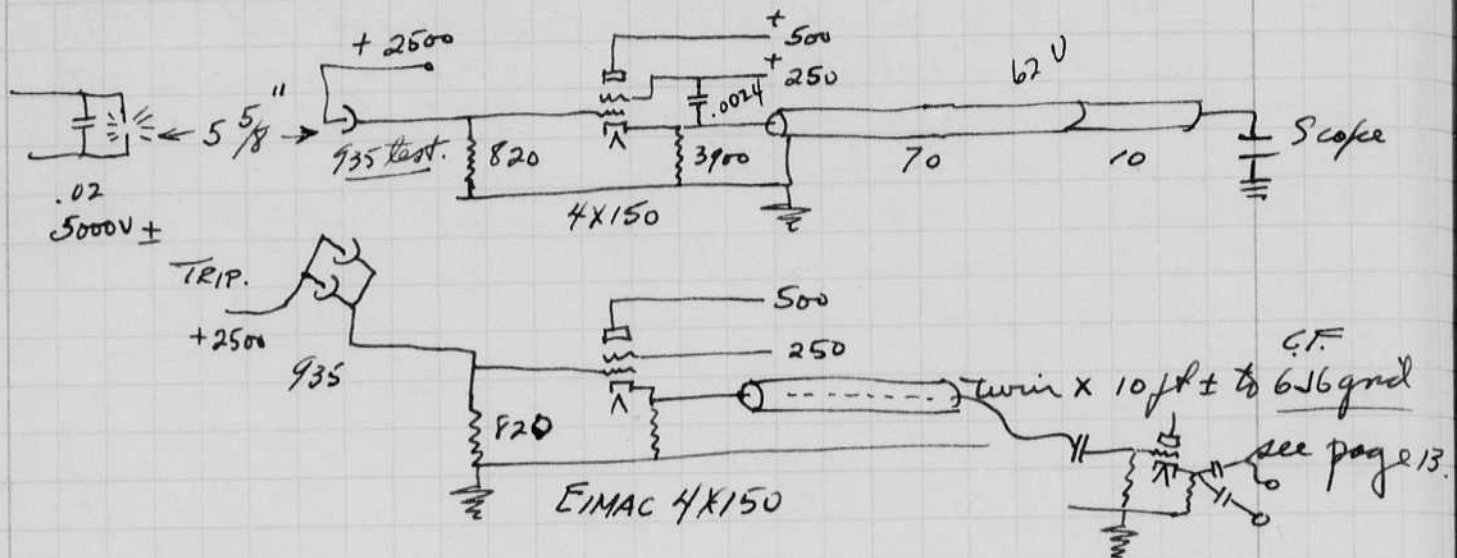

Film 32. Study of spark sources with above arrangement using # 2, 6, 11 photo tubes in parallel.

- Top. 1. Rounded gap electrodes
2. Pointed neg. grounded
3. " " " " 1 ohm in series
4. 200 mc timing wave.

Film 33. Top Spark with inductance 1" diam
 single turn of #14 wire. Capacitor is $\frac{.008 \mu\text{f}}{4}$.
 voltage about 4 or 5 thousand
 middle no inductance
 Bottom timing wave 200 mc.

.032 μf

NOTE. all osc taken today u.g. because of
 faulty connection in the ^{delay} cable near
 the scope 20 ft.

Film 34 Output of spark .032 at 4000 v.
 200 mc timing wave.

35. Spark output.
 200 mc timing wave

36. This record was made to show the effect
 of an additional 50 ft of 62V cable.
 two records were made, one had
 80 ft of cable, the other 80+50.
 50 ft of 62V was used in the trip circuit
 for the second case.
 200 mc timing wave.

40. 3 parallel 935 photocells 4x150 C.F. 80 ft 62V. Spark light
 about 10"

41. Three 931 cells with ratings 49 14 and 6
 into Colson C.F. circuit. top mid Bot.

4-12-48

NS Elgeron
Mabel Sheerhard
NS Grin

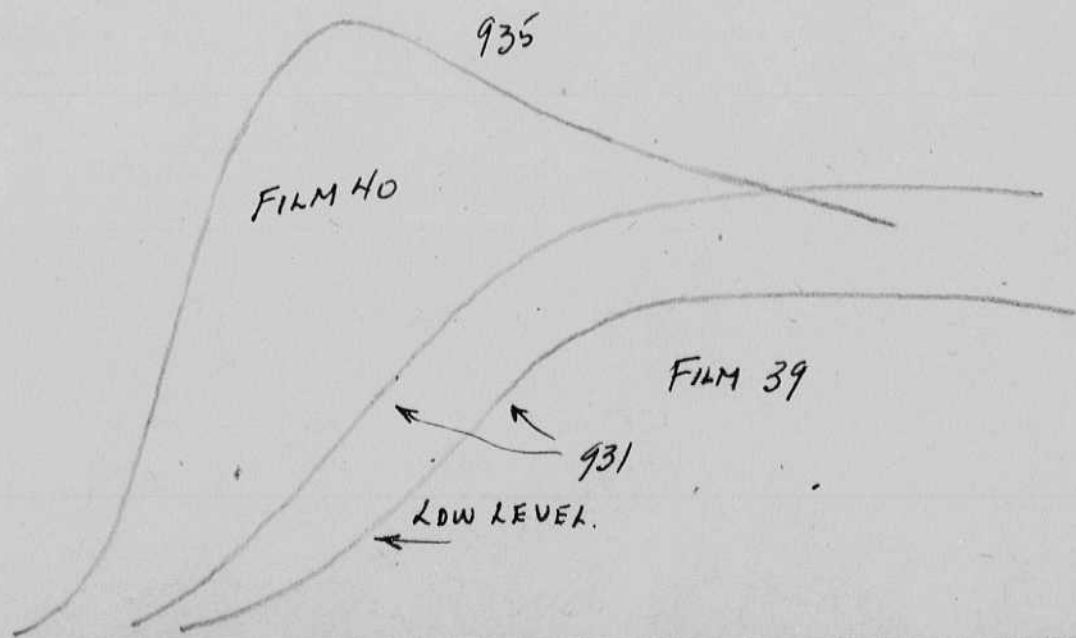
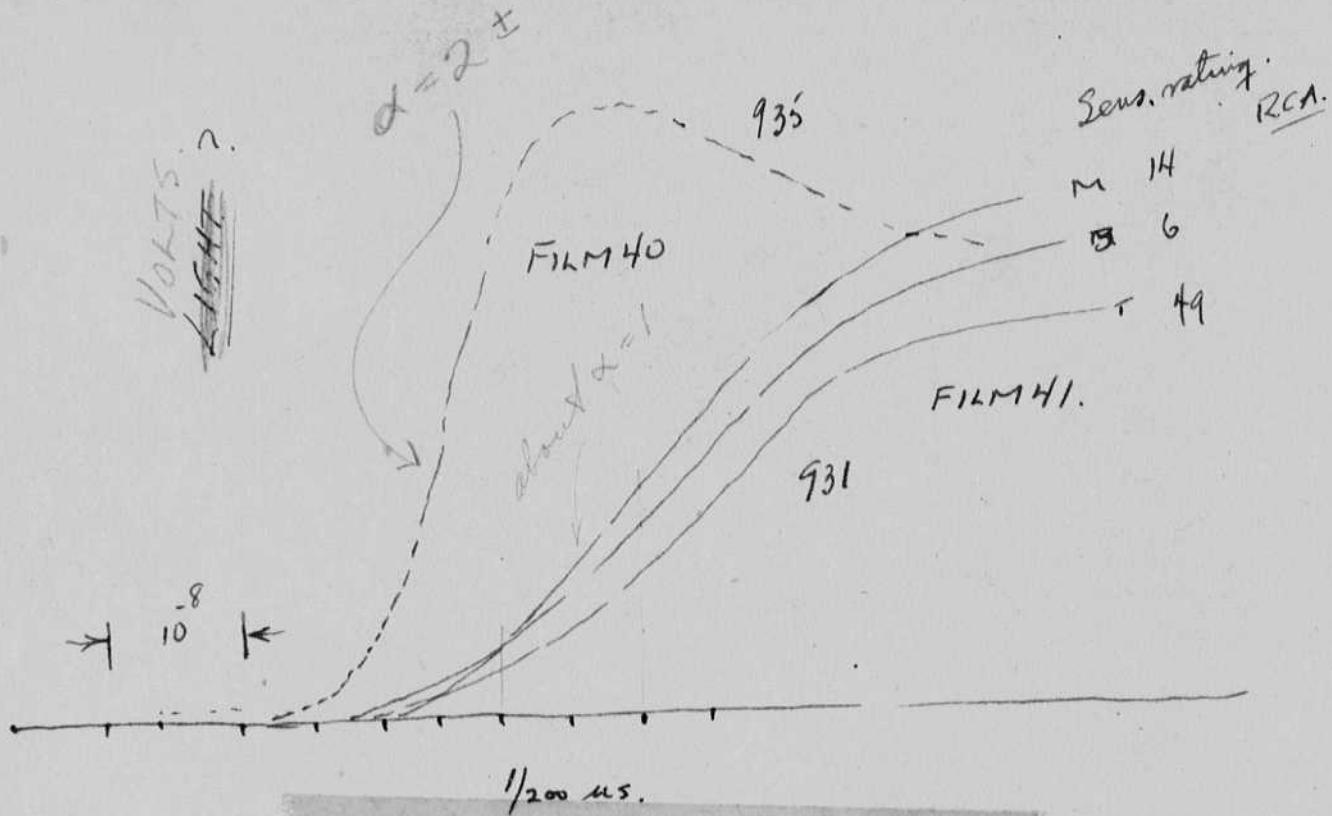

2 0 12 15/18 ... photo line at 7 22 this ...
Notebook # 18

Filming and Separation Record

___ unmounted photograph(s)

___ negative strip(s)

2 unmounted page(s)
(notes, drawings, letters, etc.)

was/were filmed where originally located between page 38 and 39.

Item(s) now housed in accompanying folder.

7
up
k.
90

4-12-48

HS Edgerton
Mabel Eberhard HS Grinn

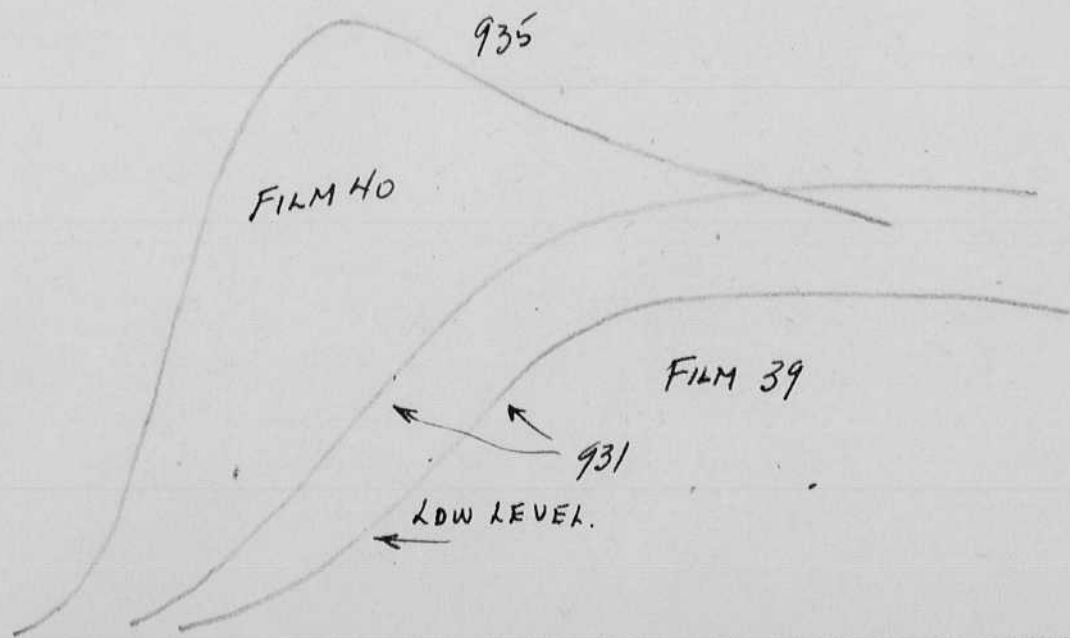
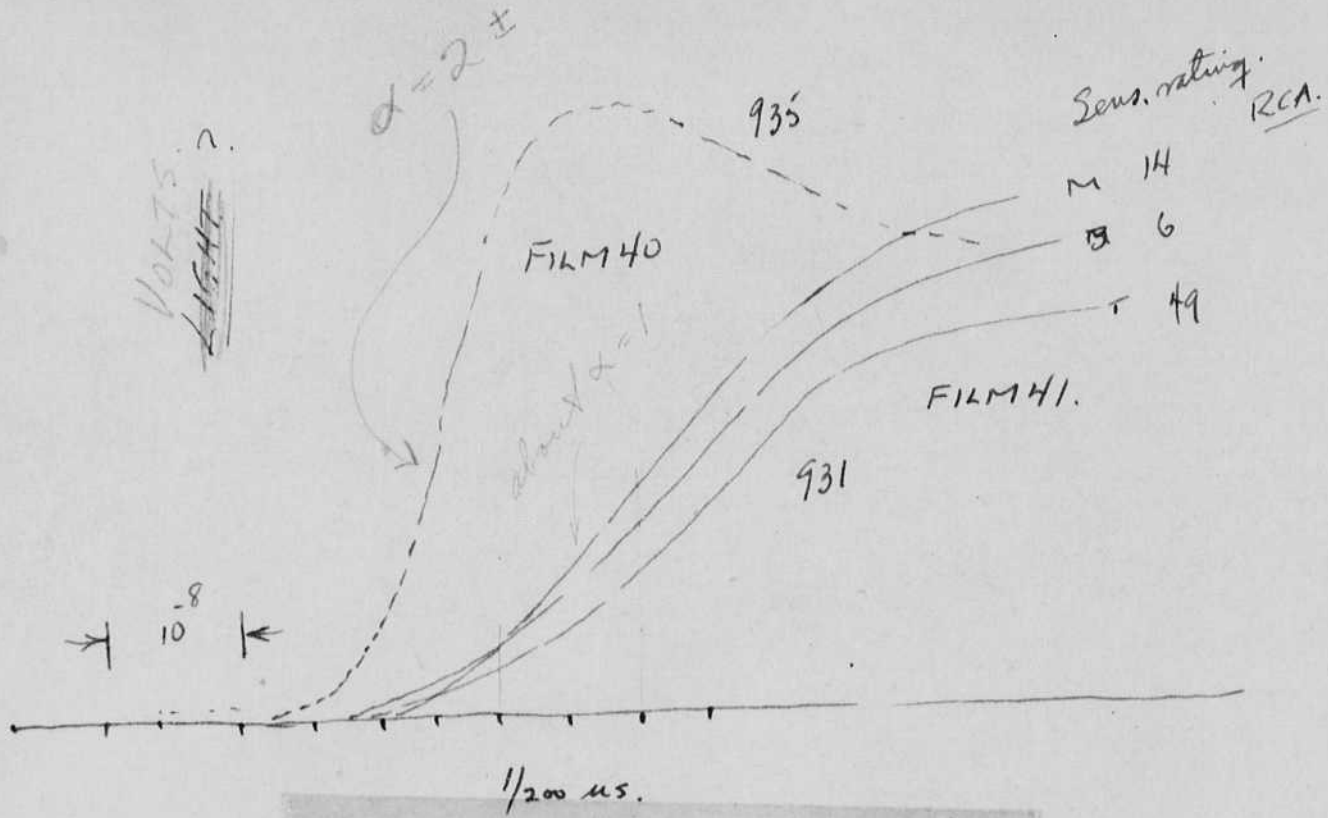

2 12 15/18
2. 12 15/18 2. 12 15/18
Notebook # 18

Filming and Separation Record

___ unmounted photograph(s)

___ negative strip(s)

2 unmounted page(s)
(notes, drawings, letters, etc.)

was/were filmed where originally located between page 38 and 39.

Item(s) now housed in accompanying folder.

7
Feb.
20

4-12-48

NS Elgeron
Mabel Eberhard

NS Grin

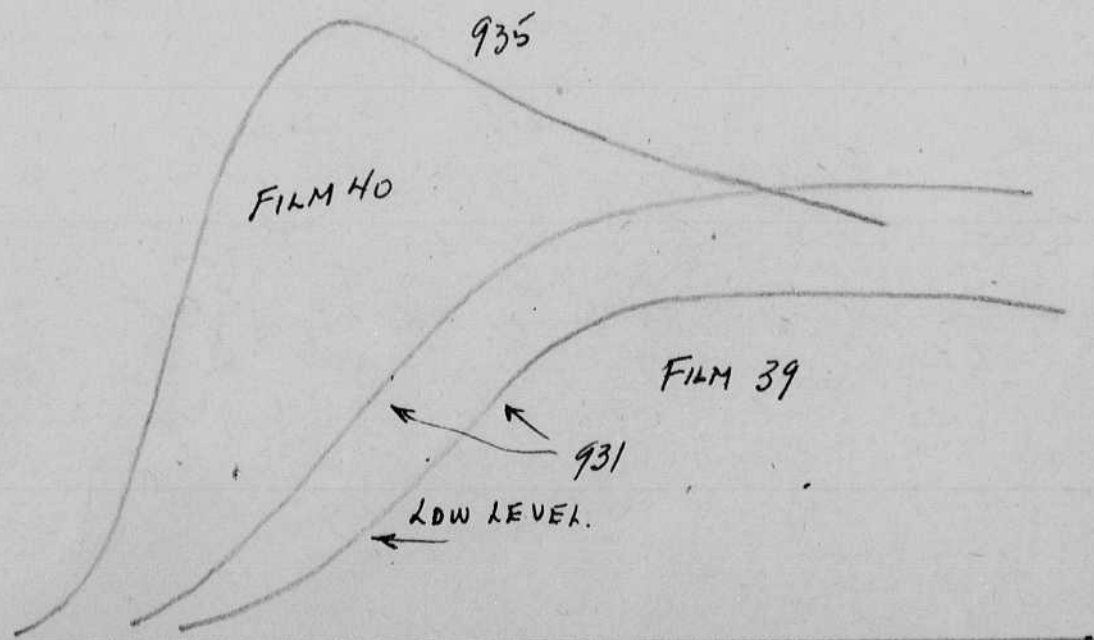
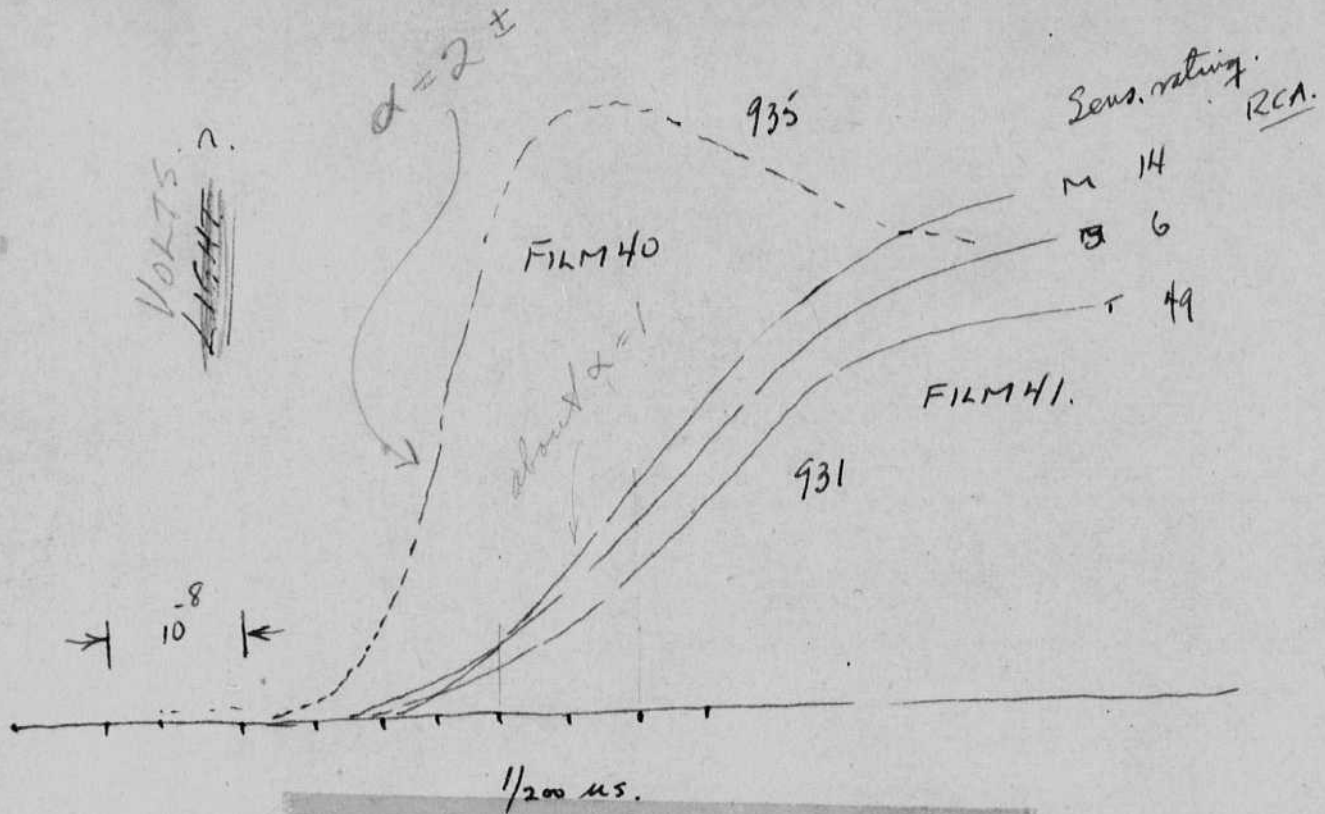

2 0 12 15/18
... to line at 7 22 this ...
Notebook # 18

Filming and Separation Record

___ unmounted photograph(s)

___ negative strip(s)

2 unmounted page(s)
(notes, drawings, letters, etc.)

was/were filmed where originally located between page 38 and 39.

Item(s) now housed in accompanying folder.

7
up
L.
90

Analysis of transformer Response to Air Spark

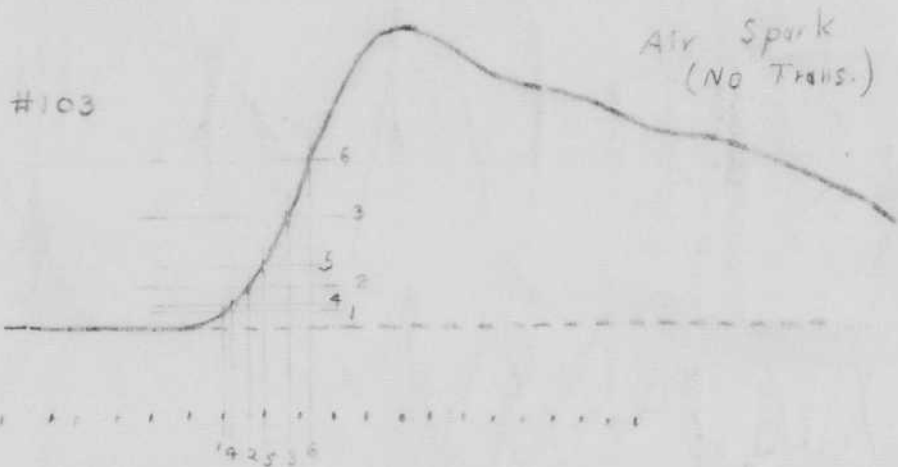

1-2 = .035	$\alpha = 2.85$
2-3 = .052	$\alpha = 1.92$
4-5 = .04	$\alpha = 2.5$
5-6 = .06	$\alpha = 1.67$

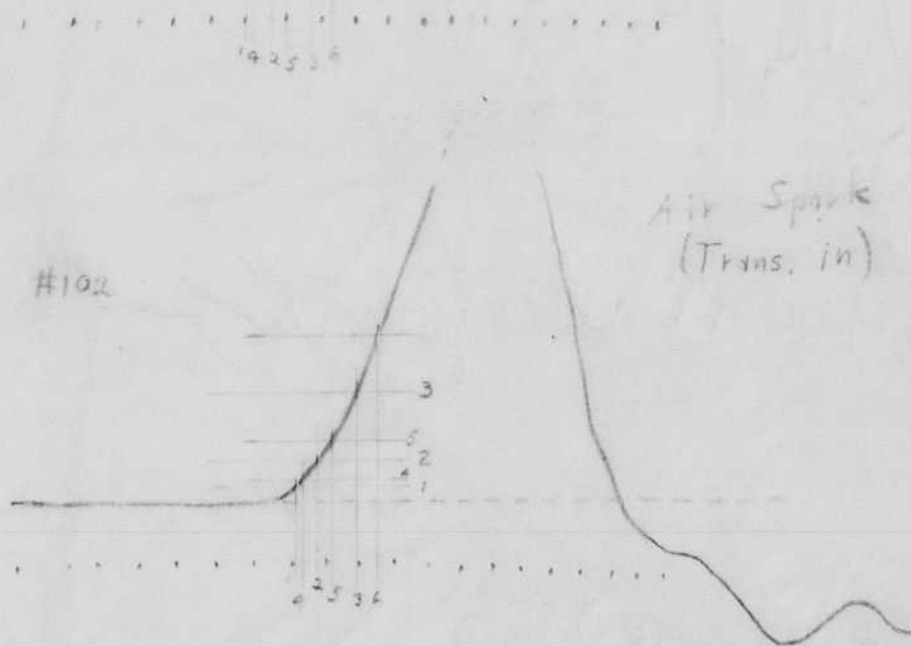

1-2 = .035	$\alpha = 2.85$
2-3 = .055	$\alpha = 1.82$
4-5 = .047	$\alpha = 2.13$
5-6 = .067	$\alpha = 1.49$

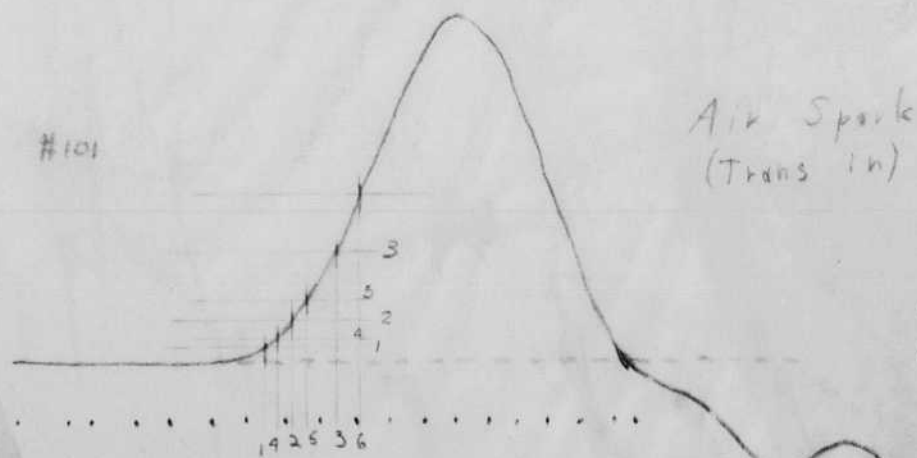

1-2 = .042	$\alpha = 2.38$
2-3 = .06	$\alpha = 1.67$
4-5 = .045	$\alpha = 2.22$
5-6 = .075	$\alpha = 1.33$

F. E. Elger
Ma. 20 '48

March 13 1948

Crossed date line at 7 22 this morning.

Analysis of Transformer Response to Argon Spark

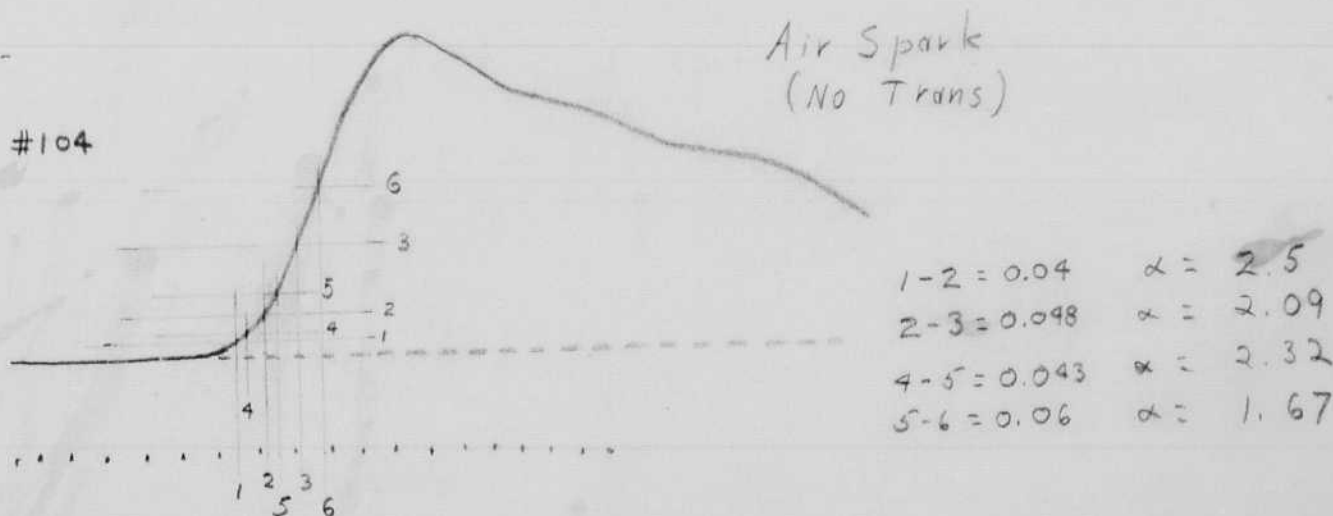
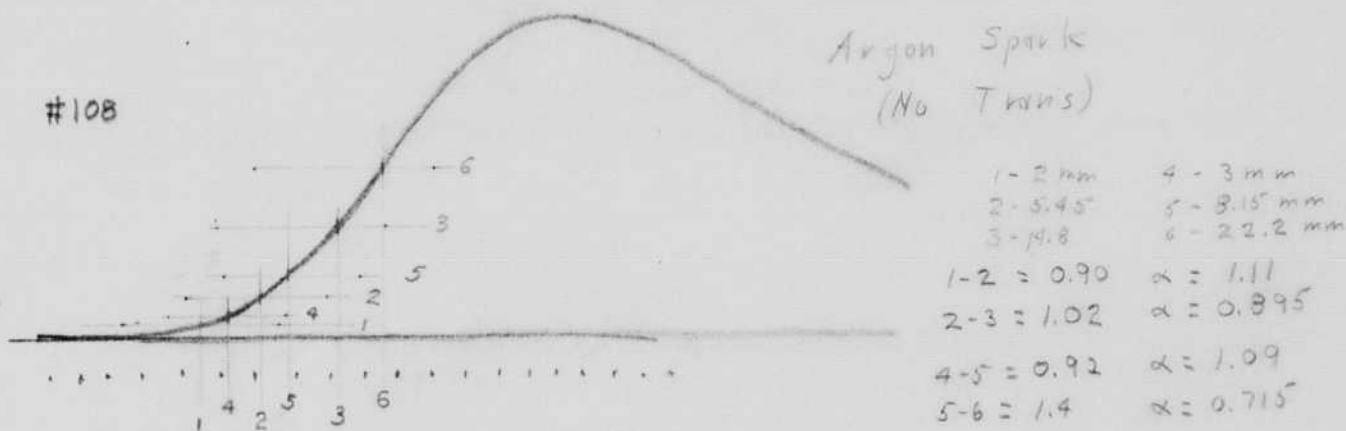
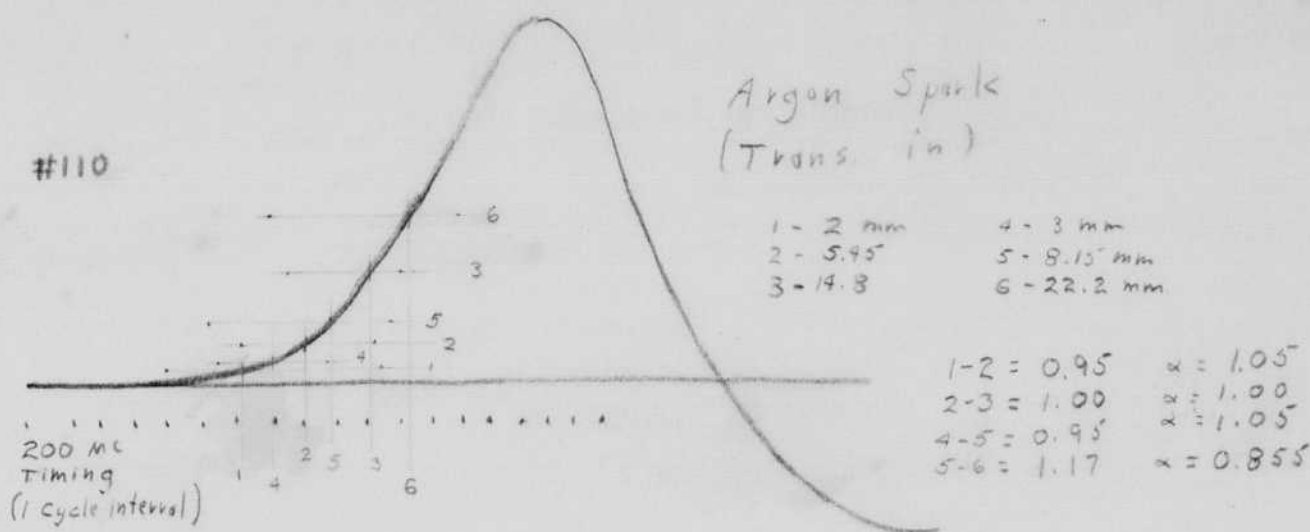

E. Eshard
Mar. 20 '48

28

17

HS Elseton

HS Quin

March 13, 1948.

Crossed date line at 7 22 this morning.

or 12
H. E. Eberhart

Conference with Grier Frohman Graves
Ogle Eberhart etc. concerning 935 and
931 tubes.

Conclusions. (1) 931 photomultiplier has delay
in starting and slow buildup.
No useful for determining α

(2) not sufficient light for 935 phototube
at 1300 yard station until 1000 ton level.
at this stage the α may be down by 10%
and ready to drop rapidly.

3. a test method of varying the buildup
of light for $\alpha = 3$ to $\alpha = 0.5$ is
needed for testing 931 and 935.
We plan to vary gas and
pressure for this purpose.

Film 46. 931 trip. 935 meas CF 110 ft 620 cable.
Spark - photo cell distance
1 1/16 14 1/2 and 7"
three traces to show effect
of intensity.

47. Argon - air comparison Trip and meas
Air 10" + Same as 46.
Argon 14" ±
~~air~~ argon 9/32" gap.

48. Argon 20-14 - 10" gap to phototubes (3 type 935)
Trip and meas
Same as 46.

Film 49 Argon Gap $\frac{1}{2}$ " in stream of argon.
 9" from gap to Photocells (3-935).
 931 - trip.
 935 - C.F. 70 ft 62V cable to scope.

Mar. 14, 1948

Film 55.

Test of R.C.A. transformer with double ended scope connection.

Spark at $10\frac{3}{4}$ " to 3 935 phototubes.

top record

Cathode Follower 4X150

50 ft of 62V cable.

Cathode follower 4X150

70 ft of 62V cable.

R.C.A. transformer

open circuited on end.

bottom record

Ditto except last C.F. feeds directly into the C.R. plate.

200 mc timing wave.

Mar 14th 1947

41

Film 57.

Edgerton.
Eberhard.

This film was to show the buildup rate of a spark in CO_2 gas. We set the gap slightly longer than required for a breakdown in air. When CO_2 gas was blown in the gap a spark would result.

Three CO_2 records were made. The top one had a zero axis.

The fourth record was an air spark at the same distance reducing the gap until self firing resulted.

200 mc tuning coil.

IMPORTANT

H. Grier
Everett Eberhard
H. Edgerton.

The sweep circuit irregularities are due to the trip signal.

Apparently the current from the trip circuit driving the 656 cathode follower and thyatron cause a time variation in the discharge rate of the sweep circuit.

We found this while trying to use a new scope, no 122 tonight. As tested, the sweep is excellent with hand trip. However the light signal causes a very irregular time sweep.

We decreased the coupling capacitor to the 656 ~~by~~ from 250 to 40 μF . There was very little effect of this change.

The screen grids of the thyatrons were connected to ground. No appreciable difference.

The 15 ft twin x 300 ohm line from the

photo all to the 656 was terminated in 600 ohms. no appreciable effect. This overheated the ~~to~~ 4X150 CF tube. Eberhard thought that ringing in the 15 W of cable was responsible for the time variations.

Mar. 15, 1948. One day out of Eniwetok.
 Harold Eberhart.

Discussed sweep troubles with Colson & Eberhard. Decided to investigate thyatron drop and grid drop when the light signal was used.

Film 59. Plate voltage of the 2D-21 with the hand trip switch.

Considerable time is required for the plate voltage to drop to a low value. Some ringing is apparent.

Film 60 Plate voltage of the 2D-21 with the light-signal trip. 200 mc signal for timing.

114

The scope was used to measure the thyatron cathode to ground voltage. This was found to be quite high and oscillatory of the same frequency as noted in the ringing shown in Film 59 and 60. The large current out put of the 656 cathode follower tube through the cathode impedance causes the voltage to ground which then appears in the sweep circuit.

A short ground wire from the thyatron to the real ground helped to reduce the pickup. A capacitor by-pass will also be used.

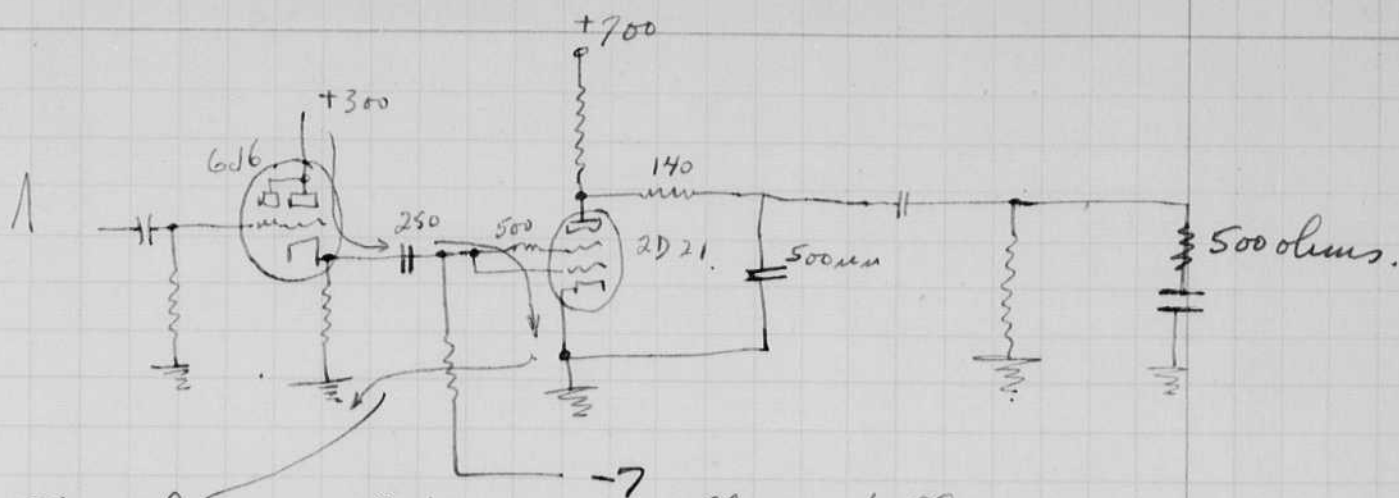

Path of large current from 6J6 cathode follower.
Ground circuit were shunt-leads so that
odd voltages would not appear in the
sweep.

Scopes 111 and 122 were worked on by
Grier, Colson, Eberhard and me.

March 16, 1948 Due at Eniwetok about noon today.

Last night and this morning we took
many oscillograms of sparks in air, argon, and
CO₂. The spark circuit consists of a
transformer rated 4400 volts, which charges a
capacitor through a half wave rectifier.

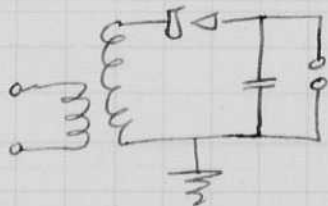

The capacitor consists of
4 mica capacitors .008 mfd each
making a total of .032 mfd.
The voltage as measured on
a Simpson meter 5000 v scale
was 4000. On open circuit it
probably is 5 or 6 thousand.

In air, the gap is adjusted to about $\frac{1}{8}$ "
so that the discharge frequency is about 1 per
second.

Argon: The gap was made about $\frac{7}{16}$ "
inches and the gas blown through the gap
to start the sparks.

CO₂ With CO₂ the gap was made slightly
longer than required for air. A spark would
result when the gas entered the gap.

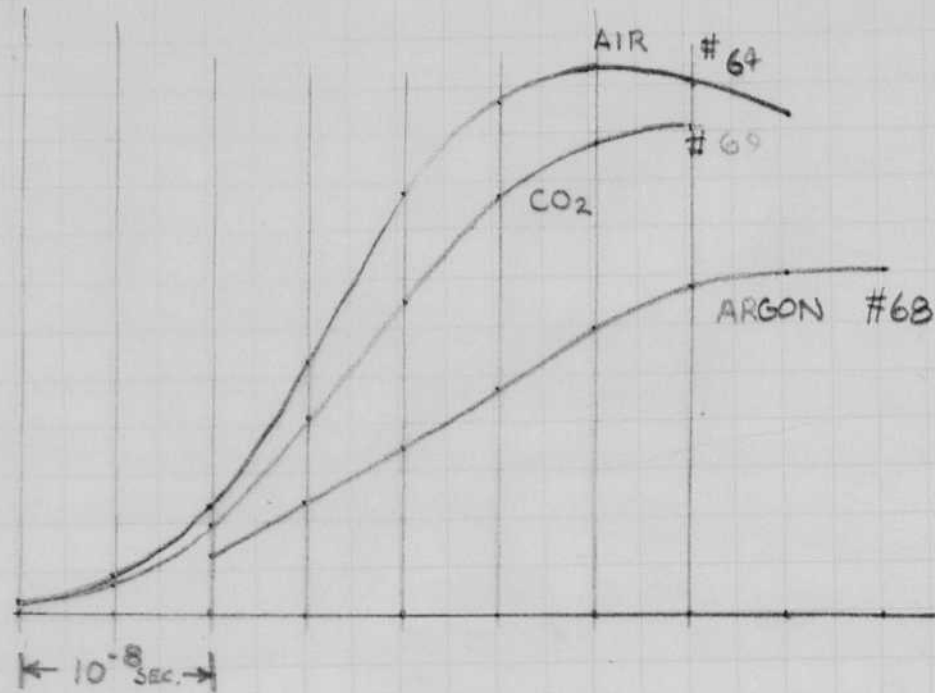

$$\text{AIR } \frac{33.5}{5} = 6.7$$

$$\alpha = 1.75 \quad (2.29 \alpha)$$

$$\text{CO}_2 \frac{26.1}{3.6} = 7.2$$

$$\alpha = 1.754$$

$$\rightarrow \text{Argon } \frac{22}{7.5} = 2.93$$

$$\alpha = 1.1$$

$$(1.37 \alpha)$$

3-16-48

45 lines

Kings data

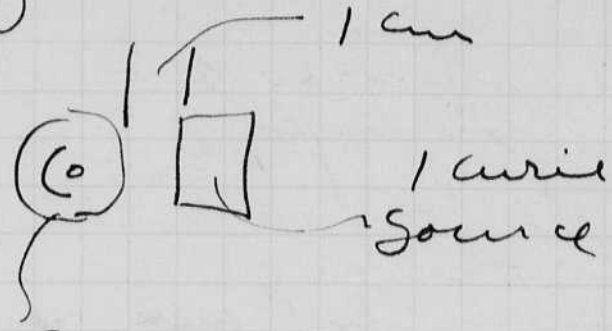

IP 21

67 1/2 volts / stage

background I without Kryptolens

1.5 uampere.

with Kryptolens 90 uA.

estimated gamma strength

3.7×10^{10} / second.

at 1 ton gamma ray intensity is known.

~~see Great Books page~~
too classified to write down

Mar 17, 1948
 Harold Edgerton.

Dawson and Smith from the AV4 came aboard and took the

- Dumont Scope with tube.
- Dumont Scope 25 KV Power Supply.
- Sweep Power supply
- Camera no 15 f 1. lens
- 6-4 X 5 Fidelity film holders.
- 6- Film Hangers.
- 1- Stainless steel water jacket & tubes.
- 6- boxes film (24 each).
- 1- shutter tripper 110 ac.

Mar. 19, 1948. Surveyed situation on Engebi island. everything looks O.K.

We are busy rewiring and making a modicum of the layout in Shop 2 on the AV5 for use on the island.

Photocell trip and pickup

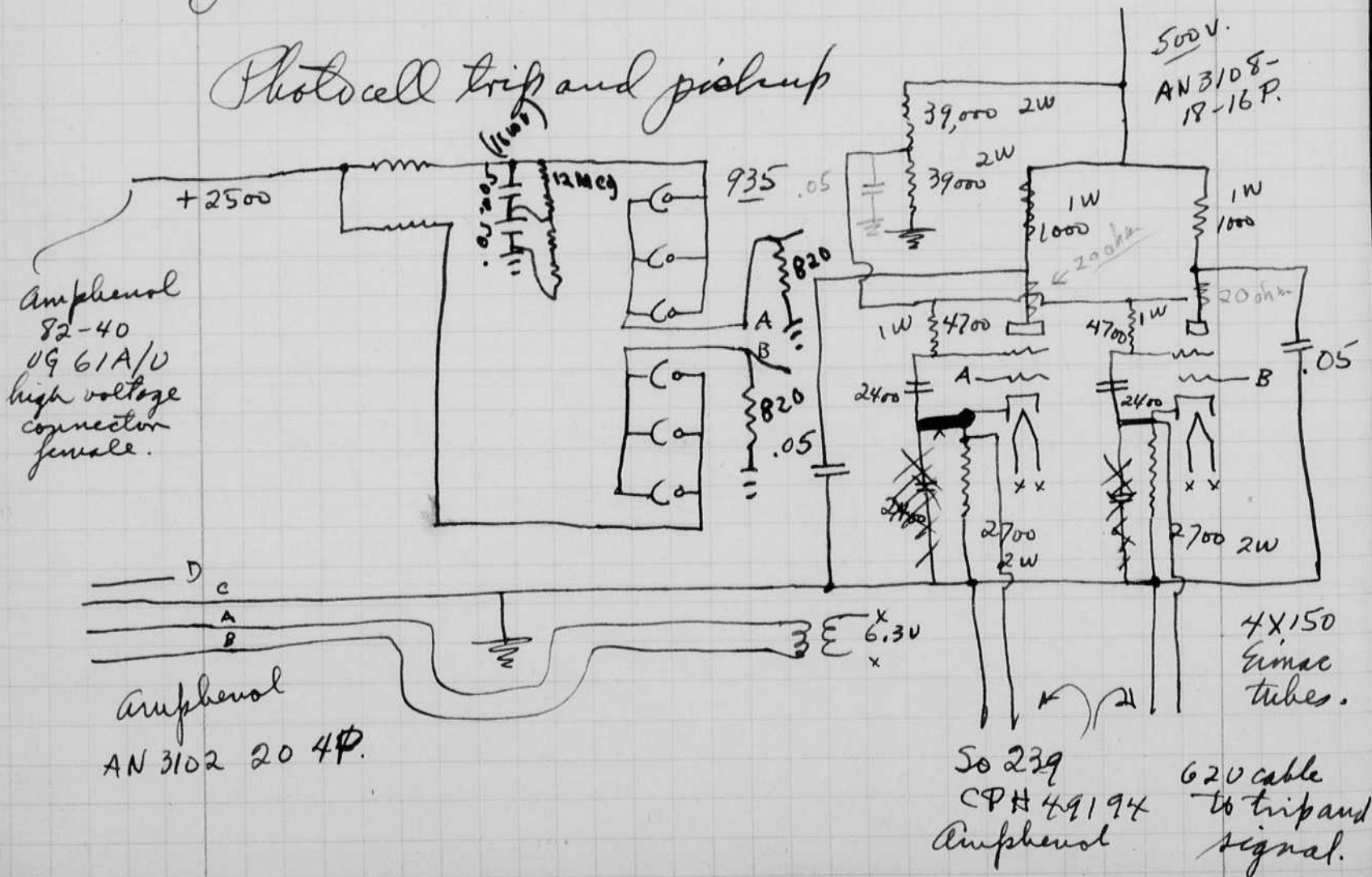

Sgt. E. Deusch photomultiplier.

- Photo 245-1 Back view Photocells and space.
- 2 Back view. Ergonomics
- 3 Front view.
- 4 Closeup of Phototube 935 & naphthalene.
- 5 Photomultiplier
- 6 Bellows view

Available space in concrete ~~of~~ bombproof house, on Angebi Island.

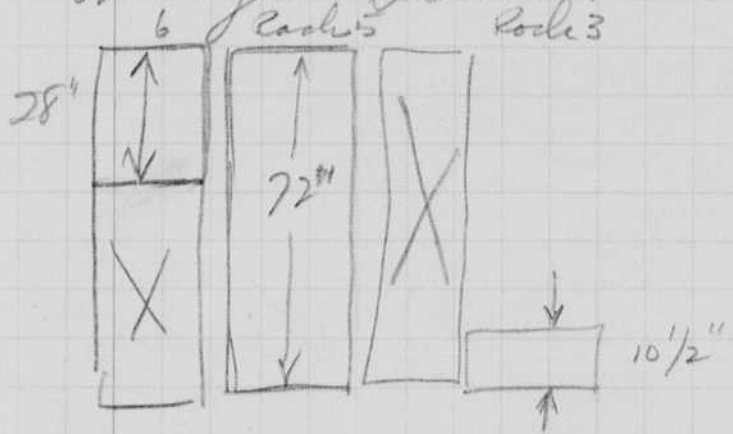

Mar, 20, 1948
David Edgerton
Ed Colson
Miles Eberhard.

Photo multiplier Circuit.

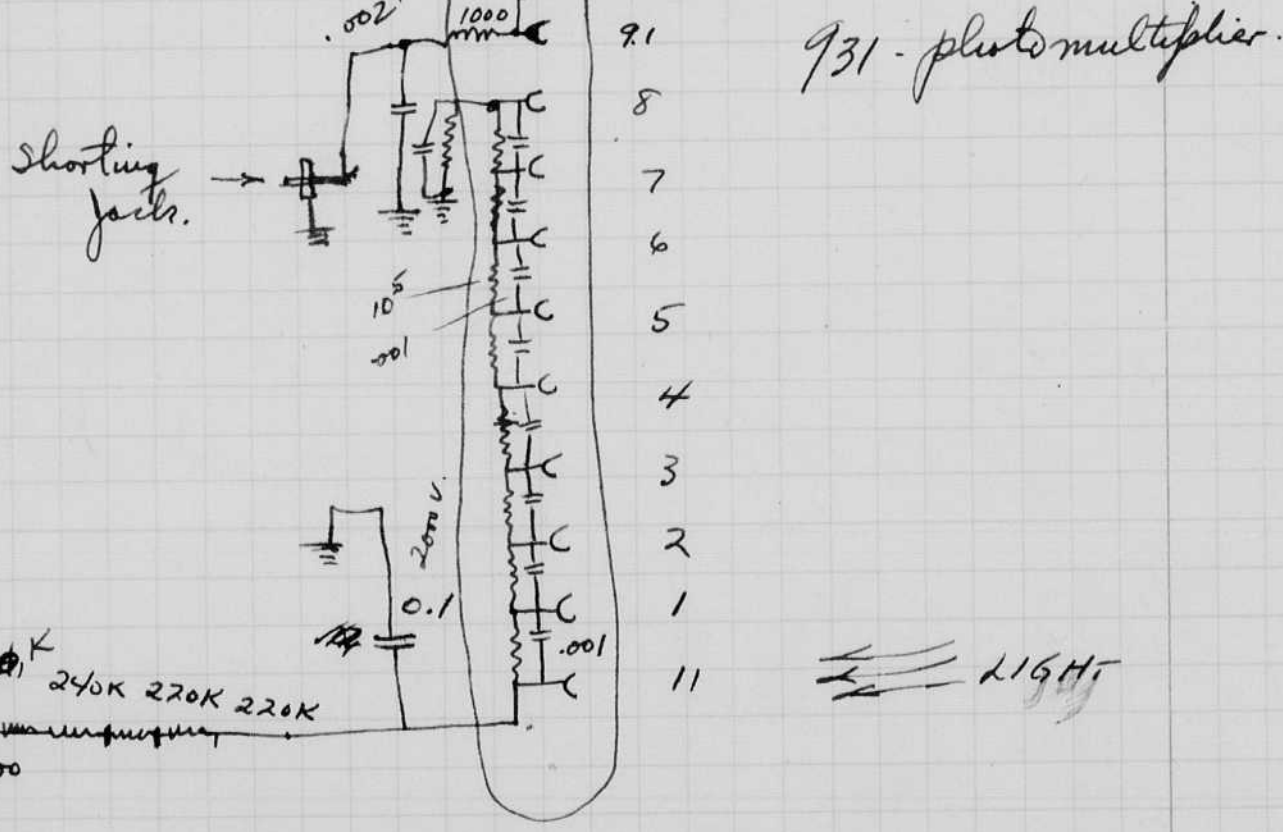
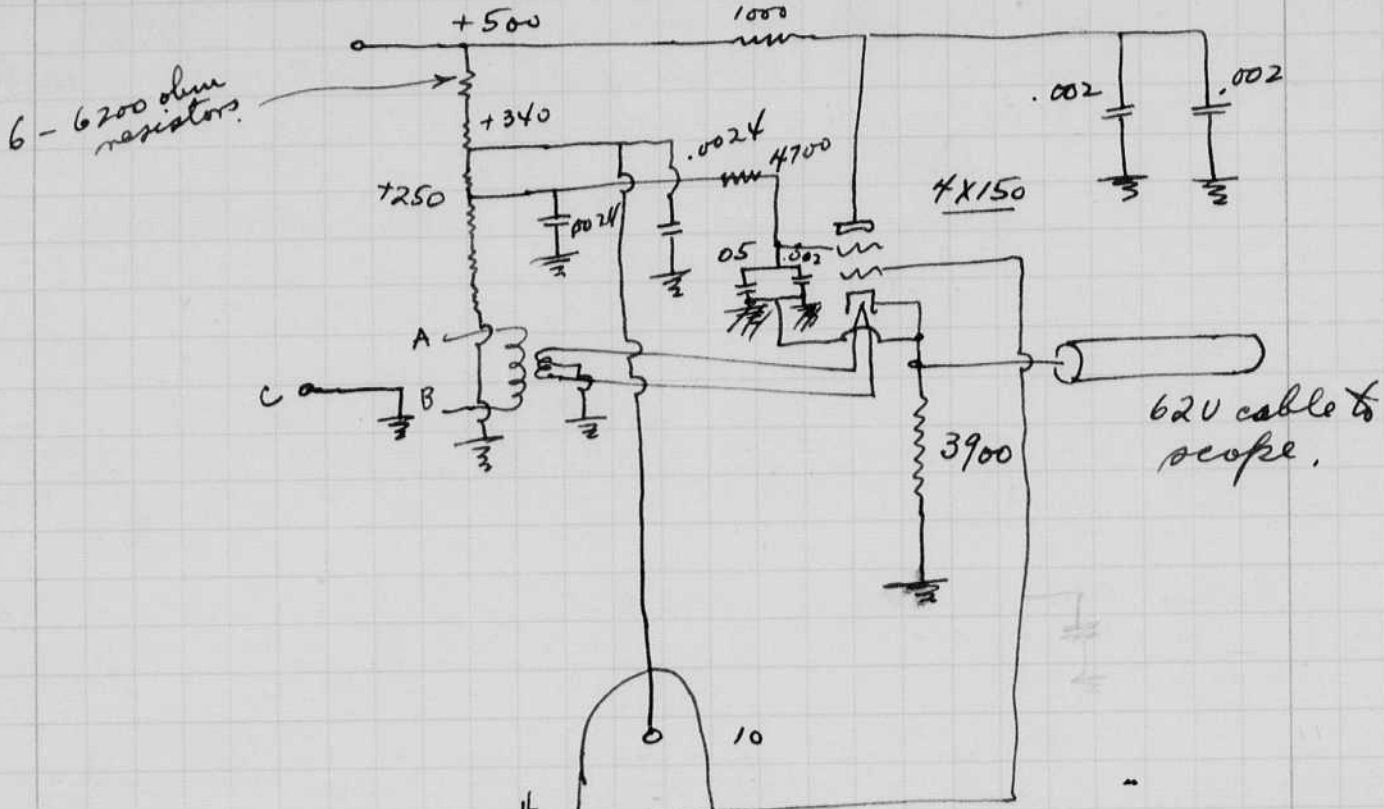

240K
240K 220K 220K
-2300

Cables.

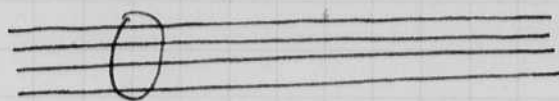

amphenol.

A - B 110 volts.
C - ground.
D - open.

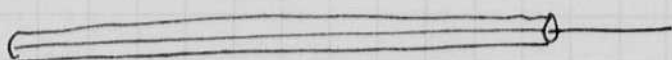

UG 61AU + 2300.

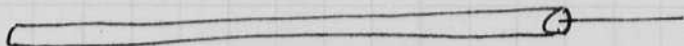

AN 3108-18-16P. + 500 volts.



50 239. 620 cable signal.

Half of the Photo multiplier circuits have parallel plugs for the first three listed above so that a second photo multiplier can be connected.

Unpacked search lights with help of Mike Warchol and Sgt. Gilbert. Prepared to install cables in trench leading from coffin.

Data on 81-101 and 81-103 cable from Fussel.

10 mc	0.37 db/100'
30	1.4
100	2.4

Photo multiplier test.

15 Watt lamp	1000 v	210 ma	20 ft	7 ma dark.
40 " "	800	125	20 ft	2 ma.

March 22 1948

David E. Engstrom.

Intensity and Sweep circuits for
 Dumont Scopes ^{to be} used at Engelb and Parry
 Islands.

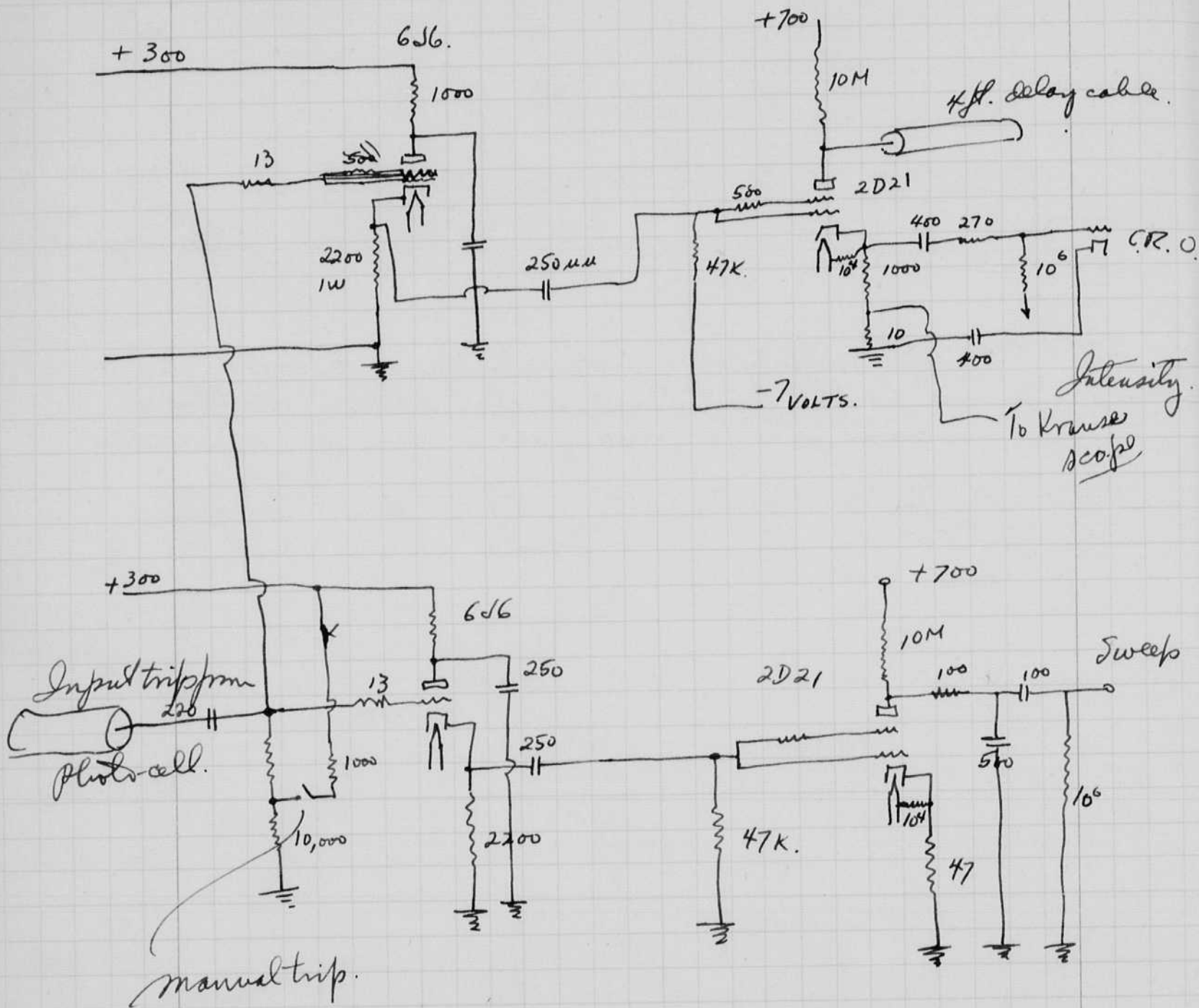

931 no 14 (Rating 17.5 RCA)

Final anode voltage 340

Large light pulses were used which saturated the cell.

Reflection cm.	V_{1-9}	I ma. steady.
-------------------	-----------	--------------------

.45	750	7
.65	800	7
.8	850	9
1.1	900	11
1.3	950	14
1.55	1000	18
1.7	1050	23
1.8	1100	26
2.2	1150	33
2.3	1200	46

Ambient light level reduced by a large factor

1.9	1100	12
2.25	1200	19
2.5	1250	19
2.6	1300	22-2
2.75	1350	28
2.8	1400	34
2.9	1450	38
3.0	1500	46-1
3.1	1550	56
3.1	1600	65
3.2	1650	80
3.2	1700	95
3.3	1730	130-

Ambient light reduced still further, also signal reduced greatly.

1.8-2.4	1730	22
1.2-1.8	1600	10
.8-1.	1400	10
.3 ±	1200	8.

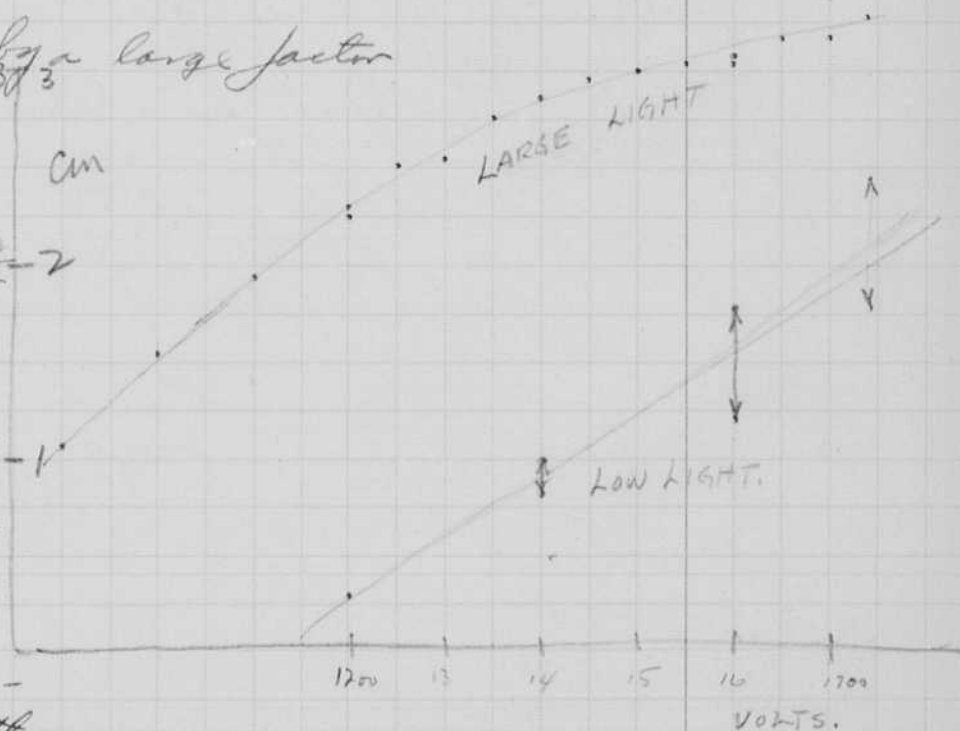

March 28 1948
 Harold E. Edgerton.

Easter Sunday. in Euiwelohalol.

Yesterday two scopes and all the equipment to operate them was taken ashore in an M boat. Grier met us at the shore with a 344 ton weapons carrier and took everything to the bomb shelter at the 1300 yd station.
 (3900 ft)

Other than trouble with two Sorenson regulators everything worked fine.

I spent the night with Barney O'Keefe in a quonset hut on Eugebi Island. Art Dvzhe assisted with the cables.

I returned to the Albuquerque AV5 at noon today so that Grier and I could check the equipment without regulators.

Eberhard has been working on a relayout of the sweep circuit and a swelching circuit to prevent multiple tripping of the intensity. The final models of these circuits were tried yesterday in one of the scopes. The circuits are shown in this book on the following page.

Sweep circuit, as used at Engeli

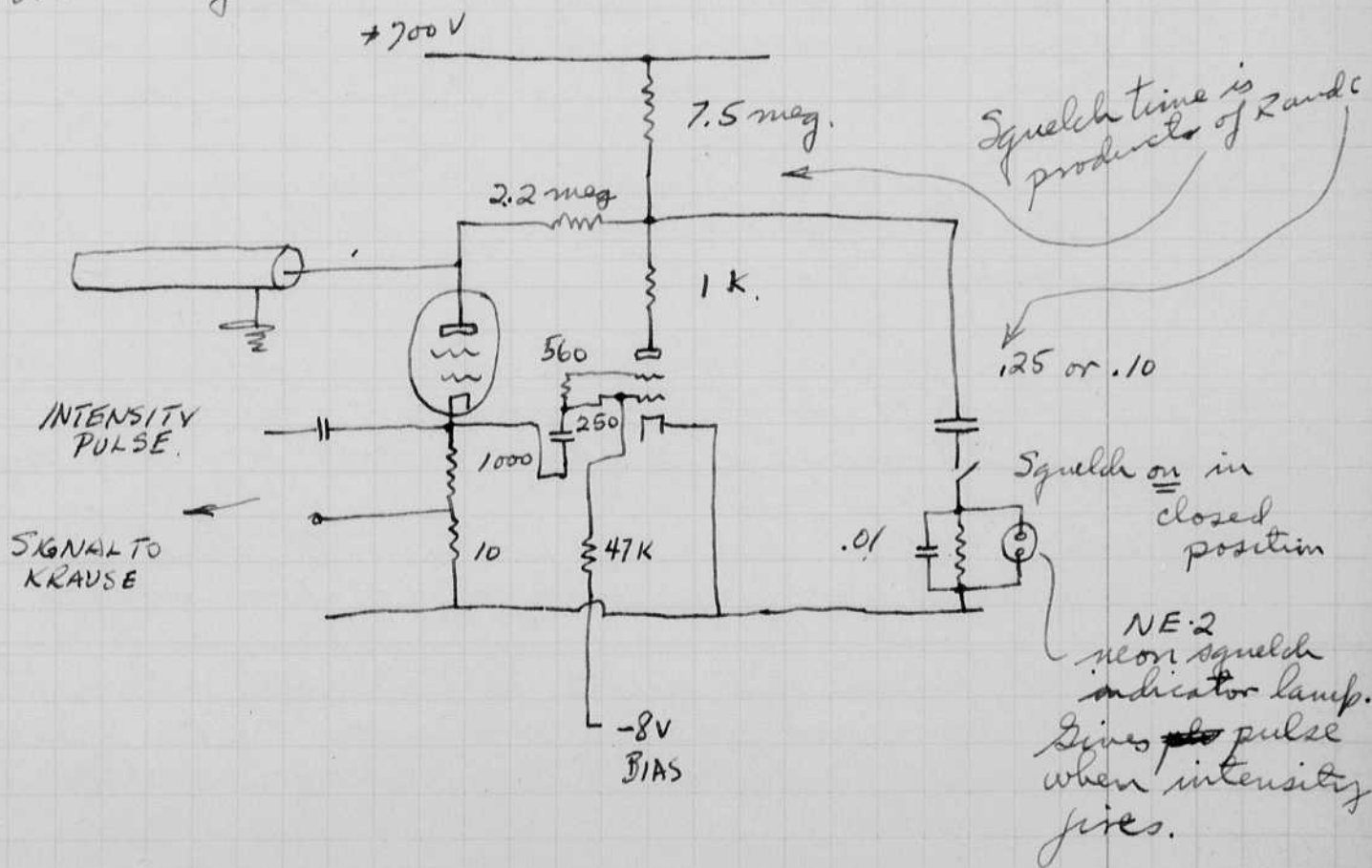
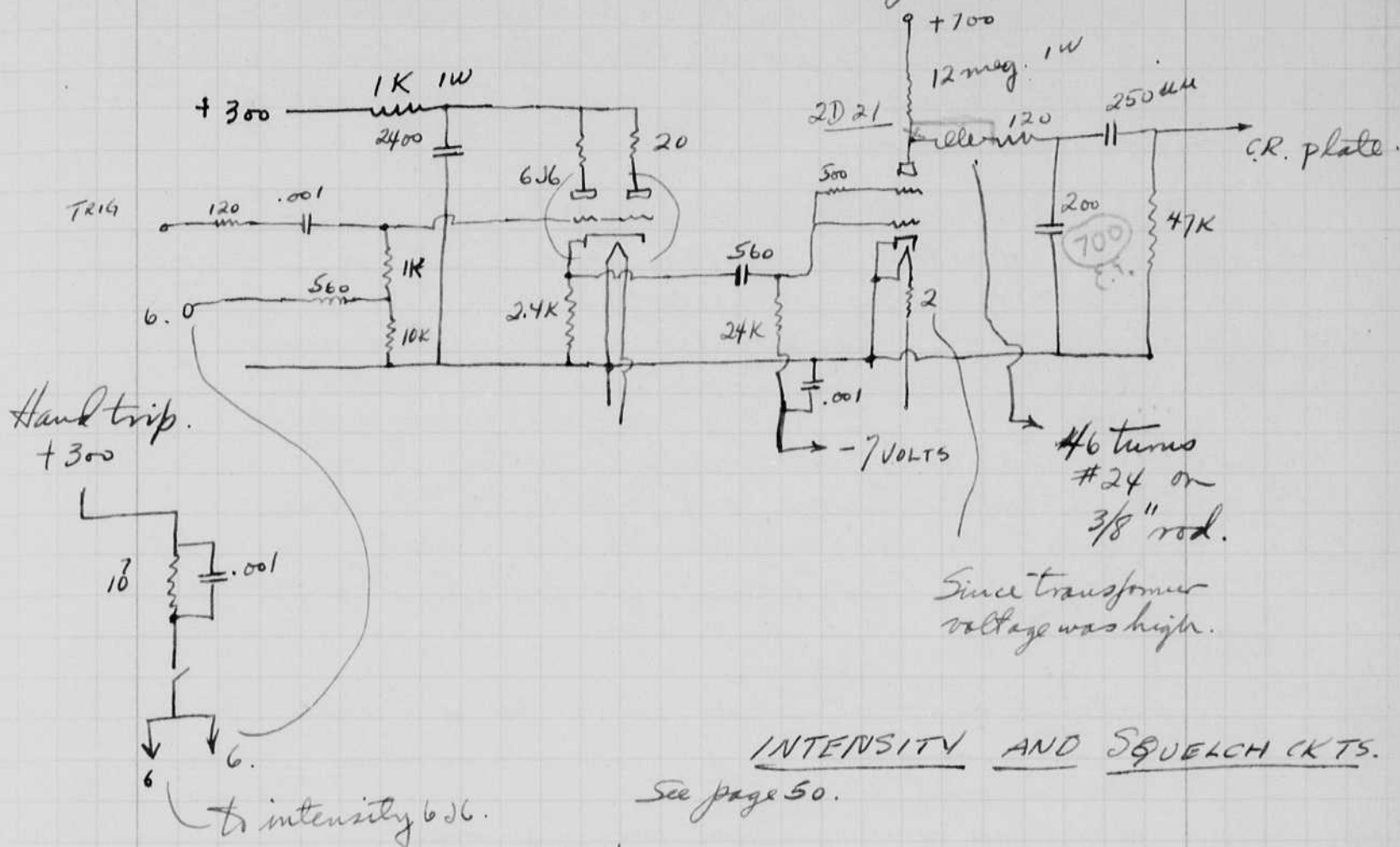

April 1 1948

Eniwetok Atoll

David S. Edgerton

at anchor near Engebi Island.

Tests were made last night on the set up at Engebi island in the shelter. The night was dark since the sky was 90% overcast and there was no moon.

There are two search lights, "36" mirrors, on top of the shelter at the 1300 yard station. These both point directly at the bomb position. A photo multiplier type 931 is located at the focal point of each search light.

Time of tests.
22 ±

The output current of the photo multiplier tube due to pick up light at the tower was about 50 microamperes (1300 volts on the first nine stages). At first the current went to 100+ μ a but then settled back within 10 seconds. The circuit may have been switched several times. This may help to bring the initial current down to normal.

The current drops to 20 μ a when the search light is swung away from the tower.

The current dropped to less than 10 μ a when the mirror was taken away.

The current was more than 250 μ a when the landing lights were at the focus of the search light.

After the tests the iris of both searchlights were left open for a day test. These had been closed most of the time before for two days.

The spark (air) at 25 ft had ample signal $4 \times .006 = .024$ mf 5000 volts \pm .
A signal $1/100$ as much appeared to be ample. We plan to test the entire set up with the spark at the tower tonight. There should be enough light to trip the scope and get a record.

$$\text{area of searchlight} = \pi R^2 = \pi \frac{36^2}{4} \approx \frac{4000}{4} \text{ square miles.}$$

area of photo mult.

$$= 1000 \text{ square inches.}$$

$$= 0.5 \text{ sq. inch.}$$

Effective distance of spark light without reflector =
 $25 \times 10 = 250 \text{ ft.}$

Increase of light with reflector = $\frac{1000}{0.5} = 2000.$

Increase of distance = $\sqrt{2000} \approx 45.$

Distance of spark from searchlight = 43×250

$$= 10,750 \text{ ft.}$$

$$= \underline{\underline{3500 \text{ yds.}}}$$

April 2 1948.

Tested 935 tubes in setup on roof of Engel's shelter last night with help from Eberhard and Drake. Out of 14 tubes we found one that glowed. This tube was # 21 and it seemed to be the most sensitive.

Tube no.	11	16	17	18	19	20	21	22	6	2	10	8	9	12
Deflection"	1	1	1	.5	.75	.4	1.2	.6	1.1	1.1	.8	1.1	1.1	1.0

Final selection for circuit Trip tubes # 8, 9, 12.
 Signal 2, 6, 11.

Photo multiplier circuit. The performance of this equipment was the same as before so apparently the exposure of the photo multiplier tube to the light has no bad effects.

When aimed at the top of the tower the trip tube # 59 reads 45 ua on an overcast night. Tube # 57 reads 25-30 ua. after the initial surge.

We were unsuccessful at tripping the scope from the 400 yard station. There were some operations

which may have been caused by some instability in the photo multiplier circuit.

April 4, 1948. #3 Egebor. Eugebi Enivetok Atol.

John Donald
Capt. Armstrong
Andrew Keller

I went to Parry Island yesterday afternoon to help Ed Colson and Harry Smith finish off the 931 photo multiplier setup.

One search light 36" is on the top of the control tower. Two other search lights are on top of a wooden structure about 50-55 ft to the south.

Light from the bomb strikes the trigger search light 40 ft before it strikes the signal search light.

40 ft of distance is equivalent to 32 ft of 62V cable. We then used two delay cables of 98 and 100 ft from the search lights to the scope signal connection.

Night light in Search light after tower lights and others were extinguished at Parry. = 25 μ a

Dark current with Iris closed = 10 μ a.

Increment from Eugebi tower 500 watt bulb in flood reflector = $\pm 1 \mu$ a.

This search light was not accurately aligned.

The ~~closest~~ trigger search light was accurately trained on Eugebi 500 watt bulb.
Night light gave 20 to 37 μ a.
Increment Eugebi 15 μ a.

Tests made tonight at Eugebi for light leaks from tower. Henderson and Gilbert. Eberhard.
11 μ a night light with floods and red light off.

5 μ a with Iris closed.

No light from 4-100 watt bulbs in tower.

No sweep trip from transportable in tower house even with the trap door open.

A sequence of oscillograms were taken of the 935 signal as a function of distance from the standard spark 0.008 uf. 5000 v. For this we used a 931 as a trip for the scope with $108 + 33 = 141$ ft of 62 v delay cable

Iris calibration for south Searchlight at Angebi

na	290	¹⁸⁰ 190	95	50	25	2
Iris edge.	15.25	5.75	3.5	2.25	1 5/16	0
	100%	⁶⁷ 65.5	37.8	17.2	9%	.69

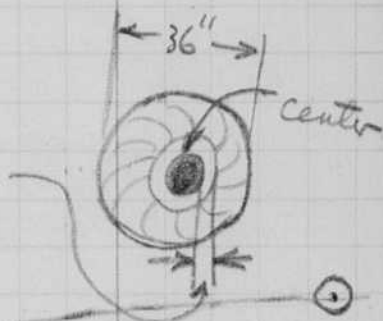

Iris edge.
300
200
100
0

na from 5000 v
lamp at 3500 ft.

300

200

100

0

5

INCHES

10

15

931 test film no
285-296 inc

4 - (1/4" on screen) SATURATION

DEF.

LIGHT PEAK.

5

100

DISTANCE FROM CENTER DISC EDGE
TO IRIS EDGE.

1000 ma in the trigger P.M. tube has no visible effect on the triggering with the spark at 3500 ft.

900 ma reduces the signal about $\frac{1}{4}$ or $\frac{1}{3}$. A photo # 290± was taken to show this.

The signal P.M. was plugged into the trip of scope 113 and the diaphragm iris cranked shut to $1\frac{5}{16}$ ". This caused the sensitivity to delay until the start was half way to the zero marker line.

At the zero marker line, the Iris was at $1\frac{1}{2}$ " opening.

The search lights were trained at the red light and the following readings made.

North - Trigger 48 ma
South Signal 35 ma.

These readings increased to 84 and 76 when the flood lights were put on.

April 5 1948. 5:45 am night light test. E. R. Taylor & G. B. Howard.

Time	Trigger	Signal	Notes
6:00 am.	96	86	(No surge) after $\frac{1}{2}$ sec. ? more than 100 ma
6:05	78, 80, 82		(Moon last Quarter $\frac{1}{3}$ across sky, to rear)
6:10	80		
6:15	90		Clear night - few very low clouds
6:20	125		
6:21	155		
6:22	180	(175-190)	
6:23	195-210		
6:24	210		
6:25	250		
6:26	295		
6:27	380		
6:28	420		
6:29	480		
6:30	540		
6:31		610	
6:32		700	(Thin - behind clouds - tower)
6:33		740	" "
6:34		720	" "
6:35		650	" "
6:36		620	clouds
6:37		600	Storm sea
6:38		600	
6:39		600	

6:40	610	
6:41	590	
6:42	550	
- 6:43½	920	(first opened other cell)
6:45	620	first cell
6:46	660	
6:47	680	

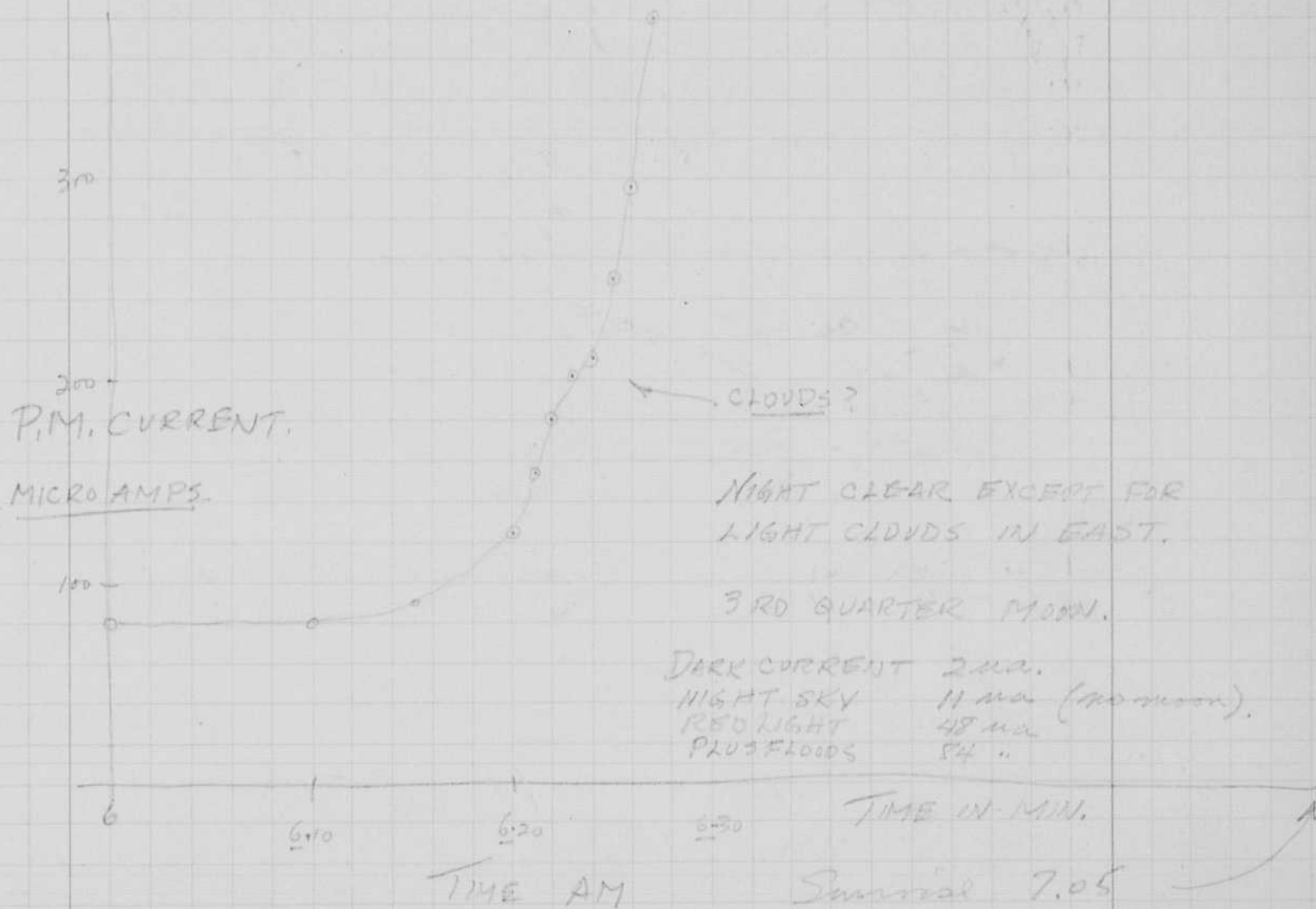

April 5 1948

David E. Edgerton Engelb. Einzelrohr.Inverse square test of 935 photocell
arrangement on top of Engelb. shelter.

Films 270 - 283 ±.

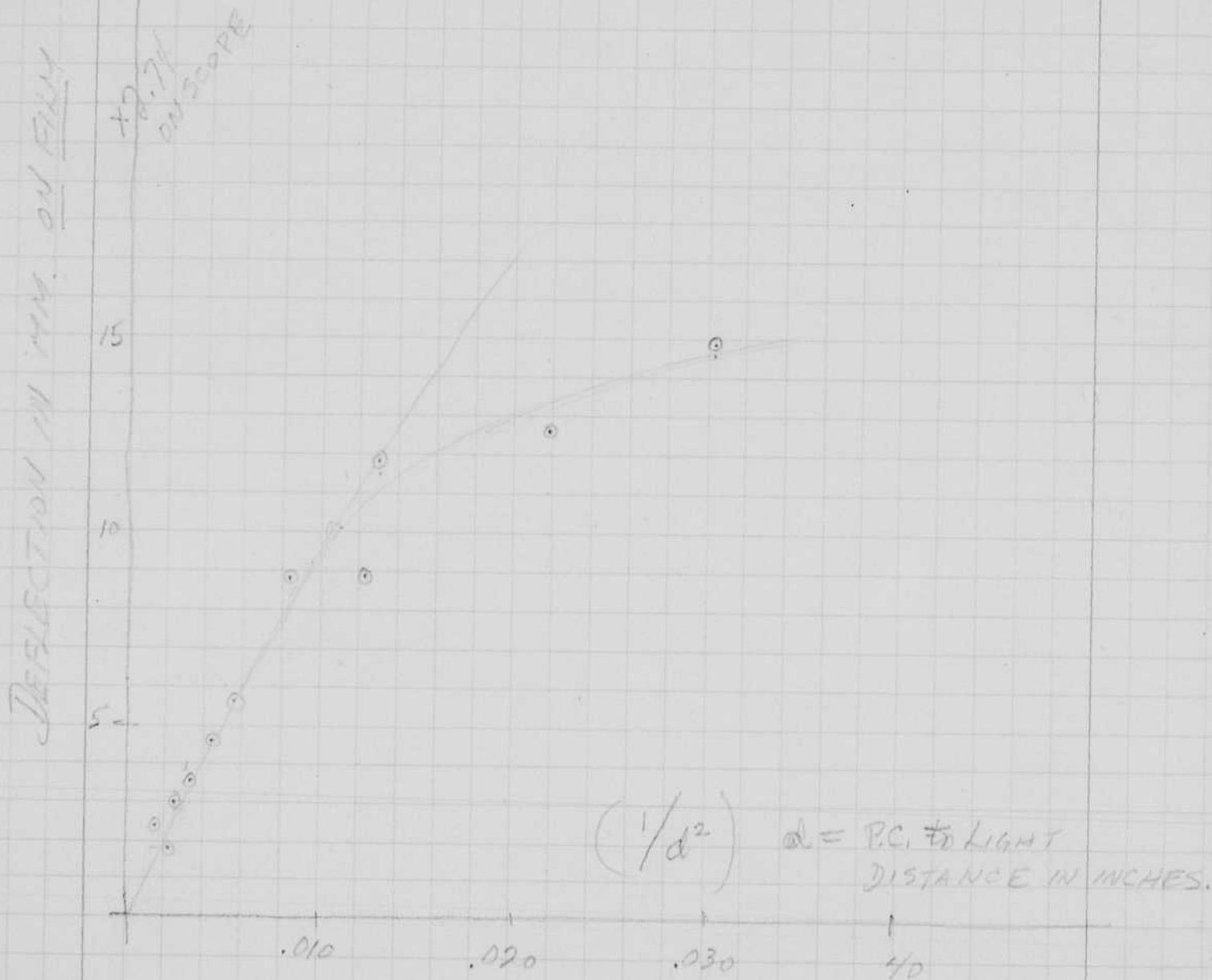

April 6 1948 - 45 today.

April 8, 1948
David Edgerton

61

A triggered spark is desirable for testing the photo multiplier setup from the tower.

We have had trouble with air (open) sparks due to humidity and wind.

I now have a sealed beam lamp as a source. This was made by burning out a truck headlight that I found on Engebi island. 28 volts was used to flash the filament. The arc was left on for about 1 second to fuse the ends of the wires into spheres. Without this procedure the sparking breakdown voltage was about 1500 volts. After arcing, the breakdown was about 7000 between the most distant terminals.

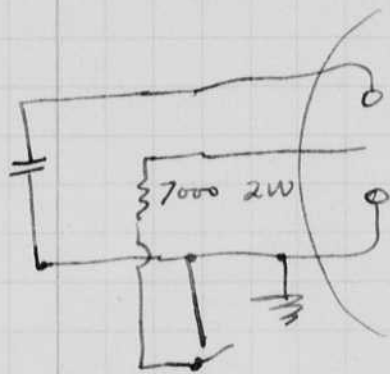

I found that I could trigger the discharge with a relay as shown. The third electrode reduces the gap and causes the ionization to start.

Sealed beam lamps are filled with argon gas at about 1 atmosphere. Some nitrogen may also be present.

April, 9, 1948
 J. H. Egerton
 Art. Drake.

Argon source for flash light.

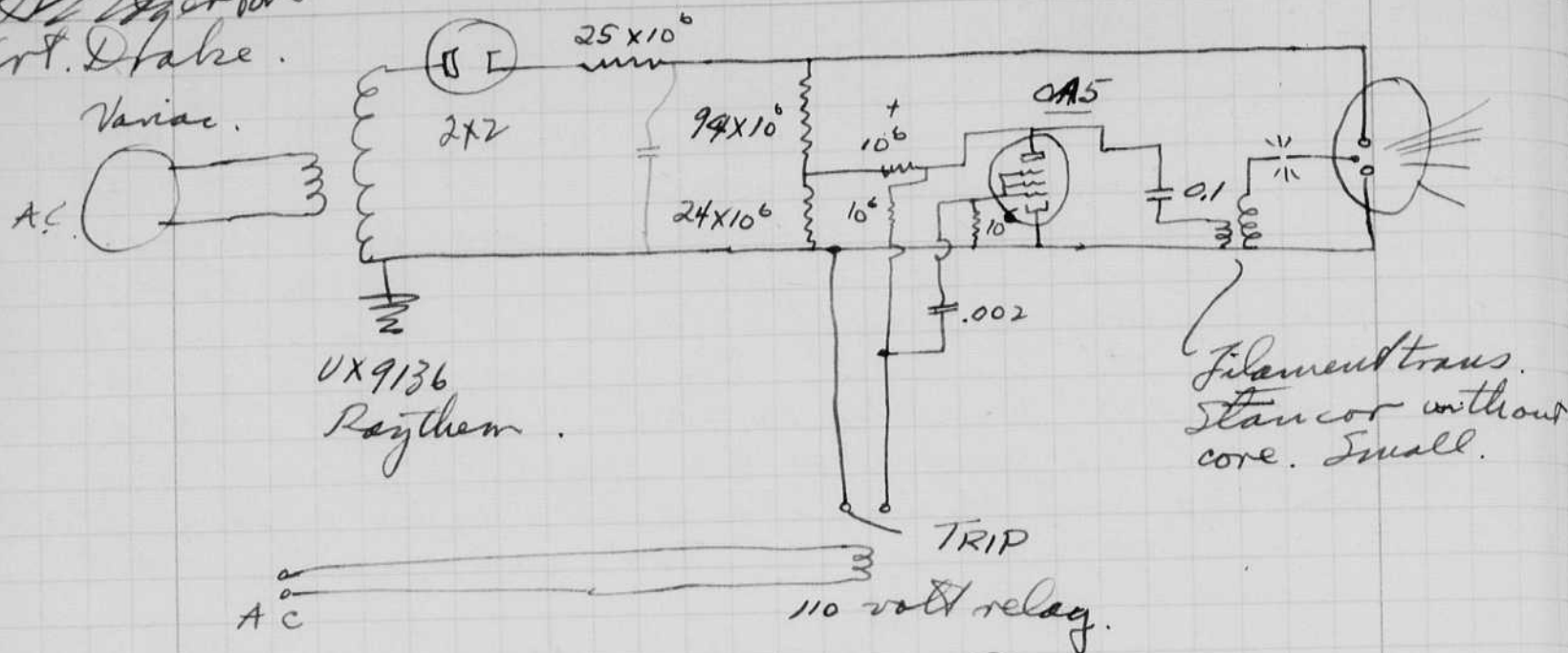

The above was wired and tried for use as a triggered source.

Evening Engebi Island - timing station with Eberhard & Drake.

The scopes 111 and 113 were put through the -15, -10, minute cycle and then calibration shots, 325 and 324 respectively, were taken. 200 mc oscillator.

An air spark gap 7.5" from the 935 photo cell.

Trigger search light

Angular variations when detected at red light. With floods on

Diam 2X15
 $\frac{31.416}{30} = 360^\circ$
 $\frac{124.748}{1} = \frac{360}{124}$
 $\frac{2.12}{1} = \frac{360 \times 1}{124}$

azimuth	0	1/8"	2/8"	3/8"	4/8"	5/8"
na	110	115	55	28	26	24

azimuth	0	5/8"	2/8"	3/8"	4/8"	5/8"	0
na	114	106	110	60	92	140	105

floods are now off. about 9 p.m.

azimuth	0	1/8"	2/8"	3/8"	4/8"	5/8"	2/8"	1 1/2"	1/8"	1 1/2"	0
na	50	68	16	8	7	16	46	68	70	56	

s	1/2	1	1.5	2	2.5	3	4	5
	48	58	61	50	28	11	10	9

The photo multipliers tools about 200 μ a when started at 9 or 830 pm due mainly to sky light. Apparently the flash bombs and the two days of sun did not effect the photo multiplier's sensitivity. Signal search light directed at 50 watt lamp ~~1200~~ 1200 yds.

$\frac{1}{8}'' = 1$	0	.5	1	1.5	2	2.5	3	4
	95	140	165	145	100	45	21	8
	0	.5	1	1.5	2			
	88	25	11	8				

Altitude of signal search light.

Set at $N\frac{1}{8}''$ mark.

$\frac{1}{8}''$ marks on $\frac{1}{4}''$ Rodium.	Depressed									
	3	2.5	2	1.5	1	0	3	3.5	4	4.5
	110	40	56	62	31	7	145	160	50	4.
	Elevated									
	3.5									
	3.5	165								

Iris calibration check.

Window open 15."	μ a	%
6.5"	195	100
4.75	152	78
3.75	105	54
3.0	72	36.9
$2\frac{3}{16}$	47	24.1
$1\frac{7}{16}$	30	15.4
$1\frac{5}{16}$	17	8.72
$\frac{7}{16}$	10	5.1
	4.5	2.3

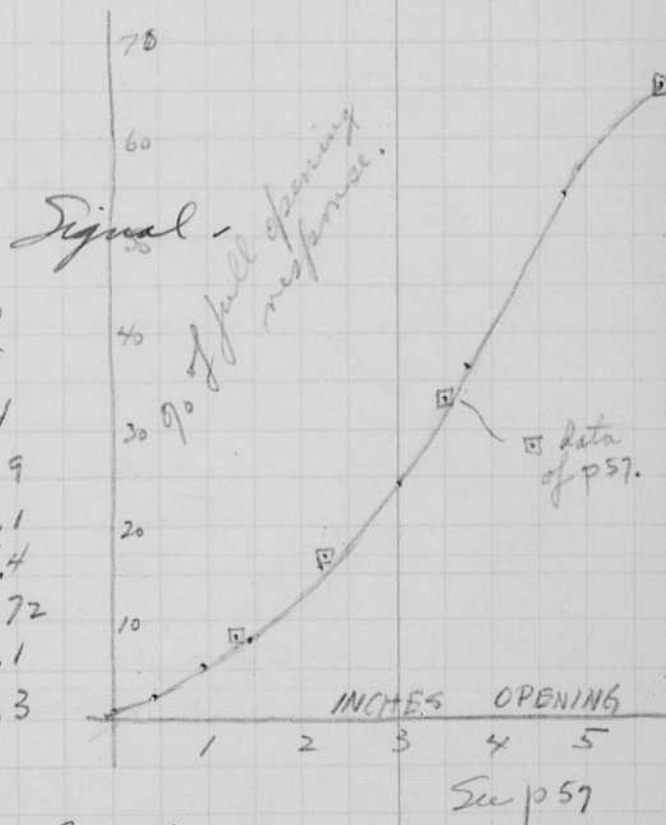

Apr. 15, 1948.

Dark current at Eugebi 931 trip = about 2 μ a.

Current " " " " = 100 to 150 μ a with tower lights and red light on.

The signal 931 photo multiplier gives the same values when the shutter is about half open. Grier is to open the shutter to this value tomorrow for the shot.

April 14 1948
Harold E. Edgerton.

Eniwetok atoll.

Conditions at Eugebi Timer station.

The timer station is located 1300 yards from the X tower which is about 200 ft high. The station is of concrete with a double door capable of withstanding considerable pressure. The oscillographs are surrounded by 12 inches of lead.

Gamma-Ray Intensity measurement.

The circuit for this test is shown on page 46. A cast naphthalene half cylinder of about 1 cm wall thickness is ~~tapp~~ taped to each of the six 935 phototubes. The 935 tubes are used in two groups of three in parallel. One set of three serves as a trigger combination to start the sweep and the intensity, the other set ~~starts the~~ puts a signal on the deflection plates after going through a 620 delay cable of 108 ft in length. The 620 cable in the trip circuit is 18 ft in length.

A cardboard box and a wooden box are mounted over the photocells to exclude visual light. Gamma rays striking the naphthalene will produce light and trip the scope if intense enough. According to recent estimates the naphthalene will not produce enough light to make this experiment a success.

The 935 phototube requires about 10^6 times as much light as the 931 photo multiplier tube. However the 931 tube ~~does not~~ apparently have ~~enough~~ the ability to follow rapid rises of light. Apparently the transit time or some delay in secondary emission causes a time error.

Thus the 935 is desired because it makes possible rapid rise time experiments. This ability is obtained at the expense of sensitivity.

The scope for the gamma ray intensity measurement is a Dumont type K1033 with 4 KV for the first acceleration and 20-21 KV for the post acceleration.

Scope no. 111 in the lower position in the center of the lead coffin was used to record the output of the 935 tubes.

There was no transit-time scope available for this experiment. Thus if a record is obtained it will not be known when it occurs in time with respect to other events.

The scope sweep length has a total time of about 0.17 microseconds of which 0.1 is the useful portion. There is a slight compression of the sweep at the beginning and at the end. Timing records for calibration have been made many times, in particular, last night.

Light Intensity measurement.

An attempt is to be made to record the light from ionization in the air caused by early gamma rays from the macular reaction. The house surrounding the bomb has been lined with paper to exclude any light that may come from the initial primer explosion.

For this test the 931 photo multiplier tube has been selected because of its great sensitivity. The photo multiplier is mounted at the focus of a 36" navy search light which is trained at the bomb house.

Two searchlight - photo multiplier combinations are used; one to trip a Dumont Scope and the other to produce a signal on the scope. Details of the circuitry are on page 48 of this note book. There is 125 ft of 620 cable in the signal circuit and 25 ft in the trip.

The dark current of the two photo multiplier tubes is about 2 μ a with the iris closed. The red tower lamp and the floods produce about 100 to 150 μ a. The signal tube will give the same current when the iris is about half closed as will be set

for the experiment.

The voltage per stage is about 150 V which is very high for this type of tube. The purpose of using a high value of voltage is to get as rapid a rise as possible from the signal. The p.m. tube response is faster with high voltage.

A signal from the intensity circuit of the scope is fed into one of Kraus's transit-time spiral sweep cathode ray scopes. Thus it will be possible to measure the absolute time between the X signal and the instant that light can be detected by the P.M. tubes.

A 50 watt lamp (tungsten) produces about 300 ma of current. The scope requires about 50 ma in the scope circuit for a fast trip. $\frac{50,000}{300} = 133$ times.

Thus the light level should correspond to that of a $50 \times 133 = \underline{\underline{6650}}$ watt lamp for a 10^{-8} or 10^{-9} second operation.

April 15 1948

67

Harold Edgerton

The Albemarle pulled anchor at Engebi island shortly after lunch and proceeded to Euiwetok. From the new anchorage I went ashore with Eberhard on Parry Island in order to open the irises of the search lights just before the flash. We slept in one of the barracks until 3 am at which time Barney & 'Keefe' joined us in going to the docks to meet Herb Gier, Al Graves, Bob Henderson upon their return to Parry from Engebi in an AVR.

The sky was clear at 3 am. To the south of Euiwetok island we could see the air planes take off. Some B-17 planes each had a pair of smaller planes to take over control as soon as the drones were off the ground. To the east we could see the freighter ships as they stood at anchor outside of the atoll. A destroyer patrolled the entrance.

At 6 am the rain started and it rained quite hard until 6:10 on Parry. This was a local squall which came up suddenly from the east. It was decided to continue with the explosion ~~was~~ due at 6:17 am.

Thirty seconds before the shot we cranked open the diaphragms for the searchlights which contained photo multiplier tubes 631 and which were trained on Engebi tower. I read 250 microamps in my meter while Mike read about 300. My dark current was 8 microamperes. We did not have an opportunity to check the P.M. tubes after the shot since we were in a hurry to calibrate the sweeps and catch the boat that took us to the Curtis, sister ship of the Albemarle. After anchoring at Aoman about 10 am we took a small boat to the Albemarle.

The two films at Parry had records that show that the light from the ~~A~~ Bob rises as fast as an air spark. Further measurements

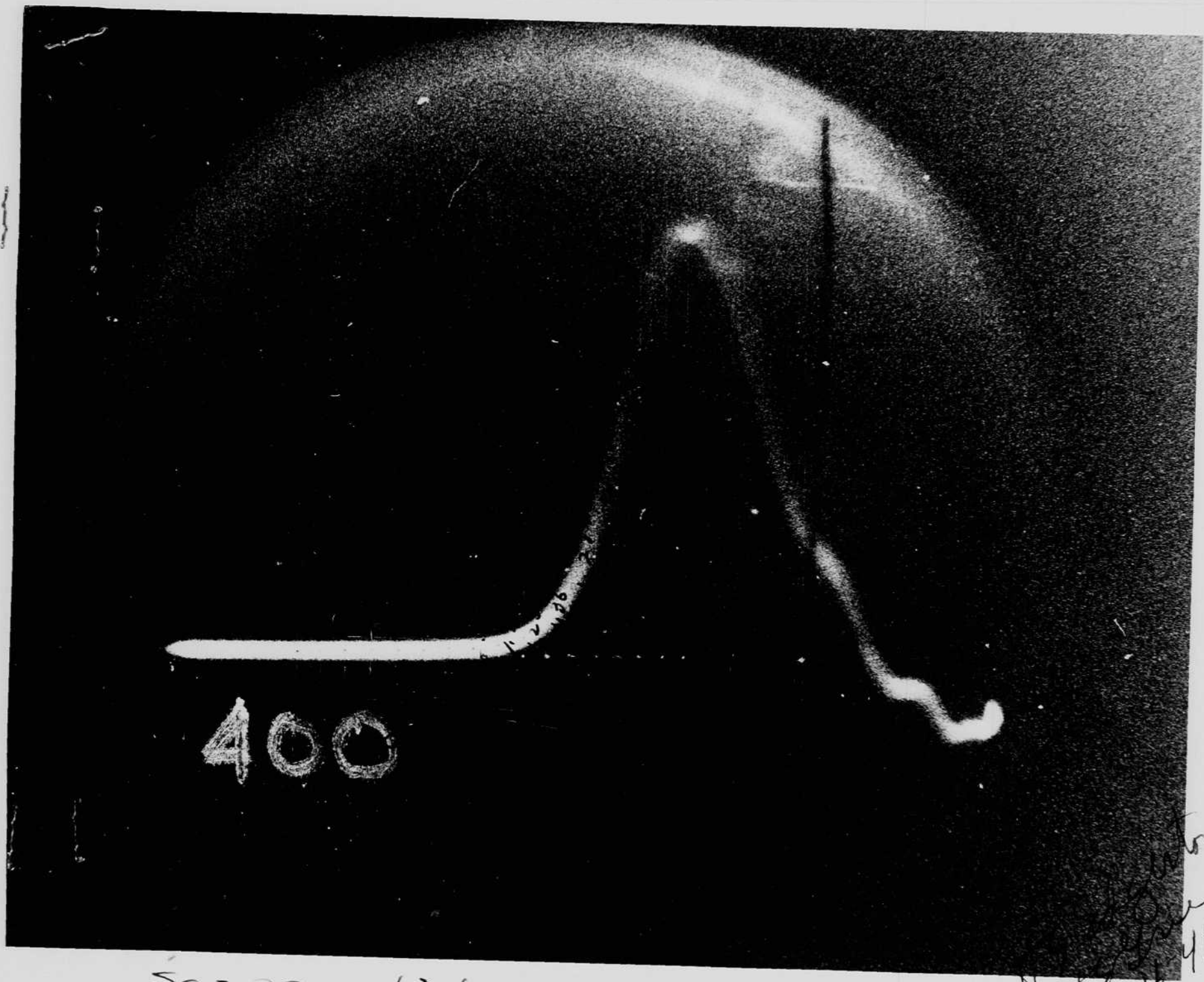

SCOPE 106

N N H-16
48

curry laboff
 AS edge
 AS edge
 H. Eberhard

4-16-48
 X Ray Data from Perry

Film # 400 Scope # 106

Film corrected for axis angle by
 Reference to film 274 - ang. calibration

TIME	λ	$\frac{R_2}{R_1}$	ln Ratio	α	$\lambda \times 100$	ln of $\lambda \times 100$
0	0					
	.02	.5			2	
10^5	.01	2.0			1	
	.02				2	
2×10^8	.025	1.25			2.5	
	.025	1.0			2.5	
3×10^8	.03	1.20			2.5	
	.04	1.33	0.285	0.57×10^9	2.5	
4×10^8	.05	1.25	0.223	0.44	3	2.1
	.08	1.60	0.470	0.94	4	1.39
5	.15	1.88	0.631	1.26	5	1.61
	.25	1.87	0.626	1.25	8	2.08
6	.55	1.97	0.678	1.31	15	2.71
	1.04	1.89	0.636	1.27	28	3.33
7	1.67	1.60	0.470	0.940	55	4.00
	2.46	1.47	0.448 0.385	0.770	104	4.64
8					167	5.12
					246	5.50

2106
273

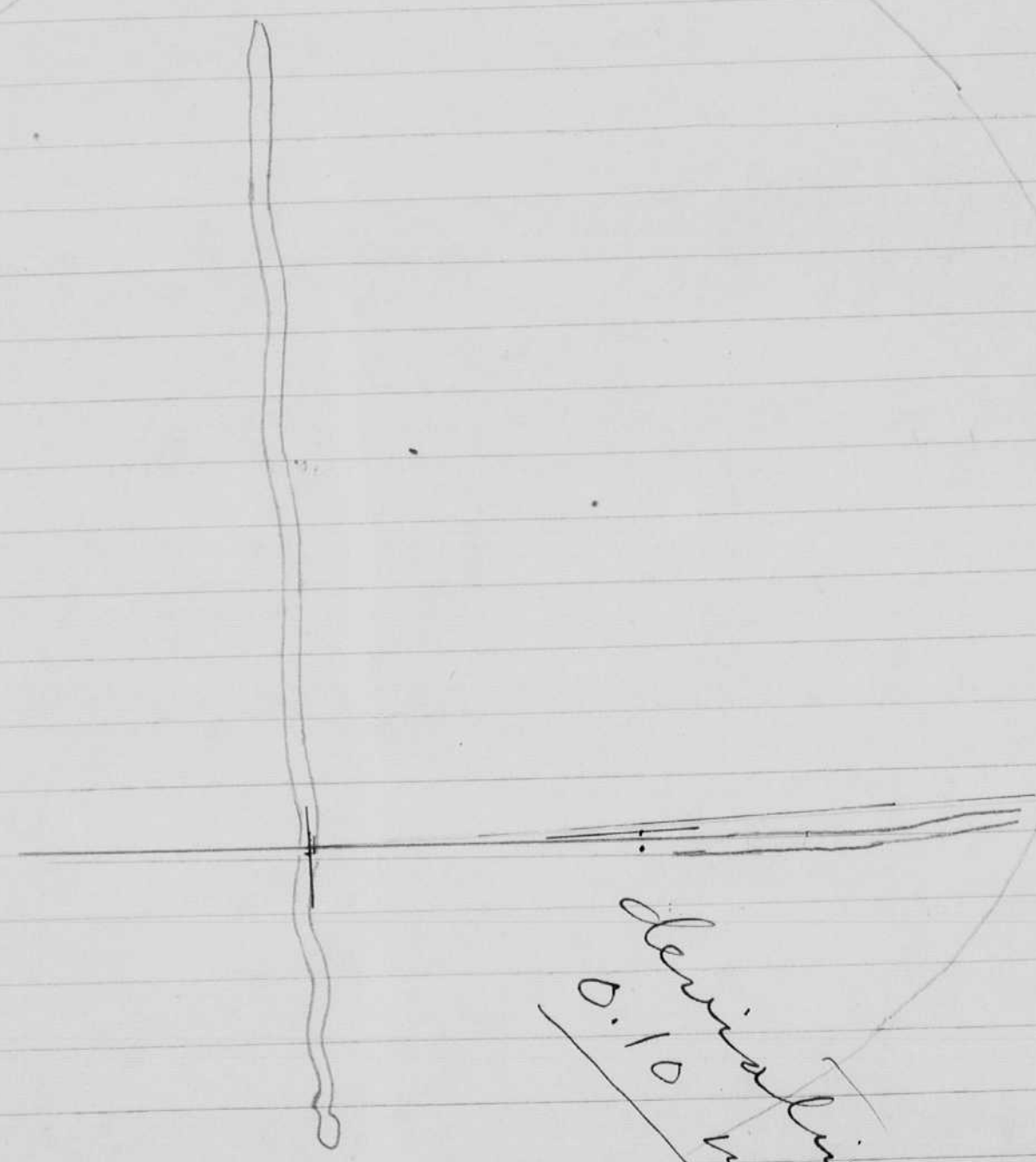

0.10
derivation

curved glass
 AS entry
 AS edge
 H. Eberhard

4-16-48
 X Ray Data from Perry

Film # 400 Scope # 106

Film corrected for axis angle by
 Reference to film 274 - ang. calibration

TIME	y	$\frac{R_2}{R_1}$	ln Ratio	α	Y_{400}	ln of Y_{400}
0	0					
10^{-8}	.02	-			2	
	.01	- .5			1	
	.02	- 2.0				
2×10^{-8}	.025	- 1.25			2	
	.025	- 1.0			2.5	
3×10^{-8}	.025	- 1.20			2.5	
	.03	- 1.33	0.285	0.57×10^8	2.5	
4×10^{-8}	.04	- 1.25	0.223	0.44	3	1.1
	.05	- 1.60	0.470	0.94	4	1.39
5 $(.075)$.08	- 1.88	0.631	1.26	5	1.61
	.15	- 1.87	0.626	1.25	8	2.08
6 $(.085)$.28	- 1.97	0.678	1.31	15	2.71
	.55	- 1.89	0.636	1.27	28	3.33
7 $(.09)$	1.04	- 1.60	0.470	0.940	55	4.00
	1.67	- 1.47	0.470 0.385	0.770	104	4.64
8	2.46				167	5.12
					246	5.50



370

scope 106

curriculum
 AS entry
 AS editor
 H. Eberhard

4-16-48
 X Ray Data from Perry

Film # 400 Scope # 106

Film corrected for axis angle by
 Reference to film 274 - ang. calibration

TIME	γ	$\frac{R_2}{R_1}$	ln ratio	α	γ_{x100}	ln of $\gamma \times 100$
0	0	α				
10^8	.02	-.5			2	
	.01	-2.0			1	
	.02	-1.25			2	
2×10^8	.025	-1.0			2.5	
	.025	-1.20			2.5	
3×10^8	.03	-1.33	0.285	0.57×10^8	2.5	
	.04	-1.25	0.223	0.44	3	2.1
4×10^8	.05	-1.60	0.470	0.94	4	1.39
	.08	-1.88	0.631	1.26	5	1.81
5	.15	-1.87	0.626	1.25	8	2.08
	.28	-1.97	0.678	1.36	15	2.71
6	.55	-1.89	0.636	1.27	28	3.33
	1.04	-1.60	0.470	0.940	55	4.00
7	1.67	-1.47	0.47 0.385	0.770	104	4.64
	2.46				167	5.12
8					246	5.50

... made in the near future... as has been noted on page 33, the photo multiplier tube lacks the ability of following rapid rises of light.

$$\frac{e^{\alpha t}}{e^{\alpha(t+\Delta t)}} = \frac{\text{Read 1}}{\text{Read 2}}$$

$$e^{\alpha t - \alpha(t+\Delta t)} = \frac{R_1}{R_2}$$

$$e^{-\alpha \Delta t} = \frac{R_1}{R_2}$$

$$e^{\alpha \Delta t} = \frac{R_2}{R_1}$$

$$\alpha \Delta t = \ln \frac{R_2}{R_1}$$

$$\alpha = \frac{\ln \frac{R_2}{R_1}}{5 \times 10^{-9}}$$

curry laboff
 AS
 AS
 AS
 H. Eberhard

4-16-48
 -- X Ray Data from Perry --

Film # 400 Scope # 106

Film corrected for axis angle by
 Reference to film 274 - ang. calibration

TIME	γ	$\frac{R_2}{R_1}$	ln Ratio	α	$\gamma \times 100$	ln of $\gamma \times 100$
0	0					
	.02				2	
10^{-8}	.01	.5			1	
	.02	2.0			2	
2×10^{-8}	.025	1.25			2.5	
	.025	1.0			2.5	
3×10^{-8}	.03	1.20			2.5	
	.04	1.33	0.285	0.57×10^9	2.5	
4×10^{-8}	.05	1.25	0.223	0.44	3	2.1
	.08	1.60	0.470	0.94	4	1.39
5	.15	1.88	0.631	1.26	5	1.61
	.27	1.87	0.626	1.25	8	2.08
	.55	1.97	0.678	1.36	15	2.71
6	1.04	1.89	0.636	1.27	28	3.33
	1.67	1.60	0.470	0.940	55	4.00
7	2.46	1.47	0.448 0.385	0.770	104	4.64
8					167	5.12
					246	5.50

f-16-48

110

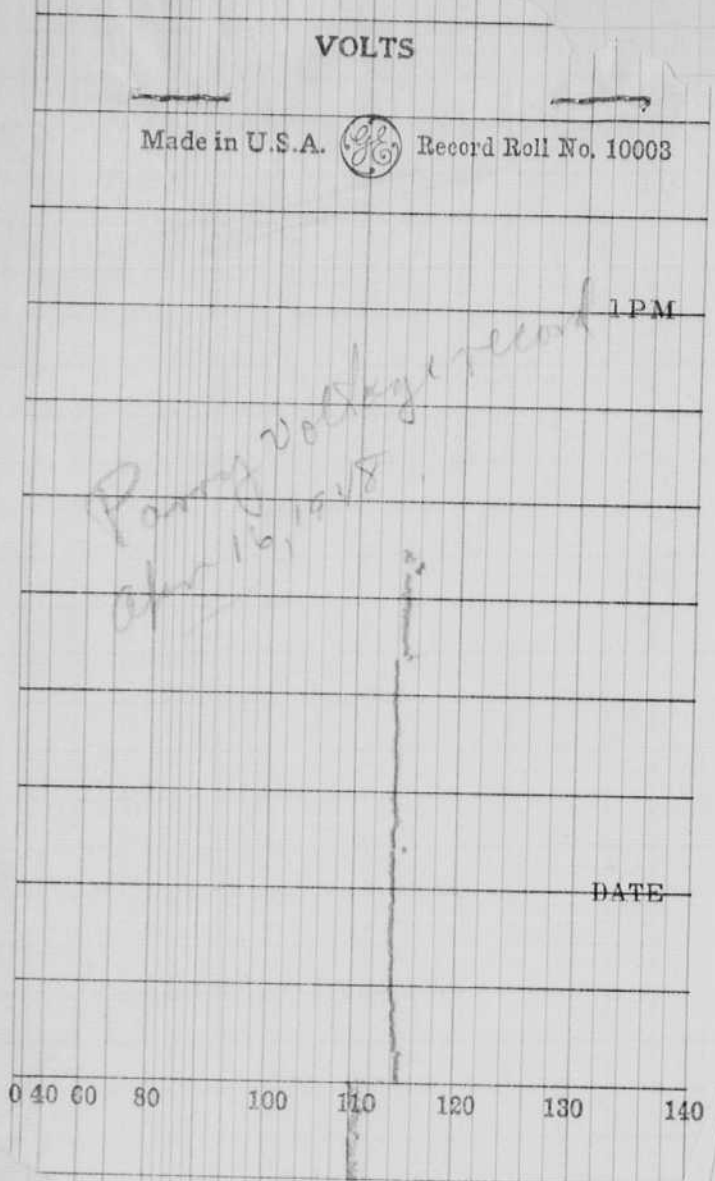

Parry voltage record
Apr 16, 1948

Record Roll No. 10003

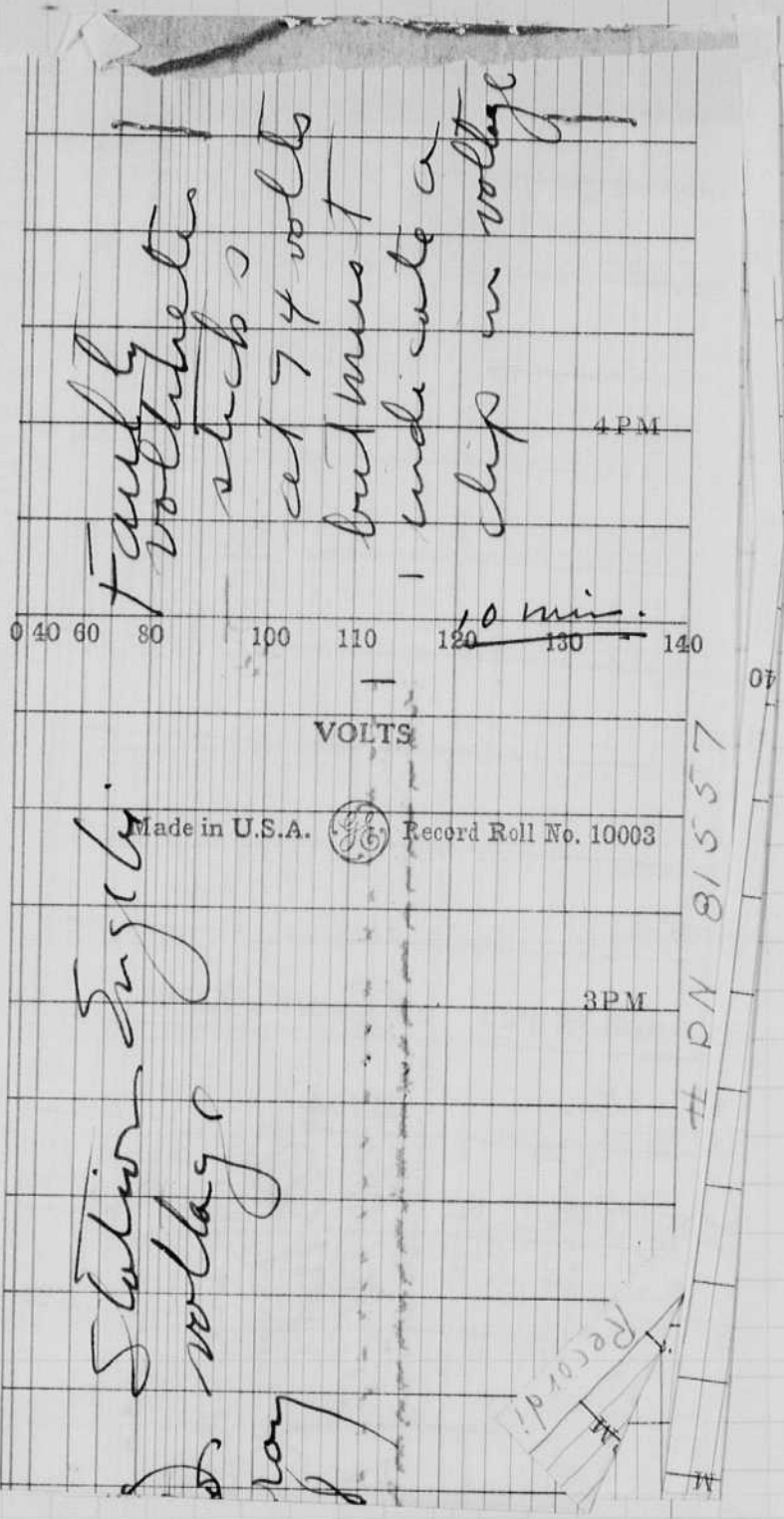

Faulty voltmeter sticks at 74 volts but must indicate voltage drop in voltage

Station engine voltage

10 min.

PN 81557

voltage recorder data
X Ray Dory

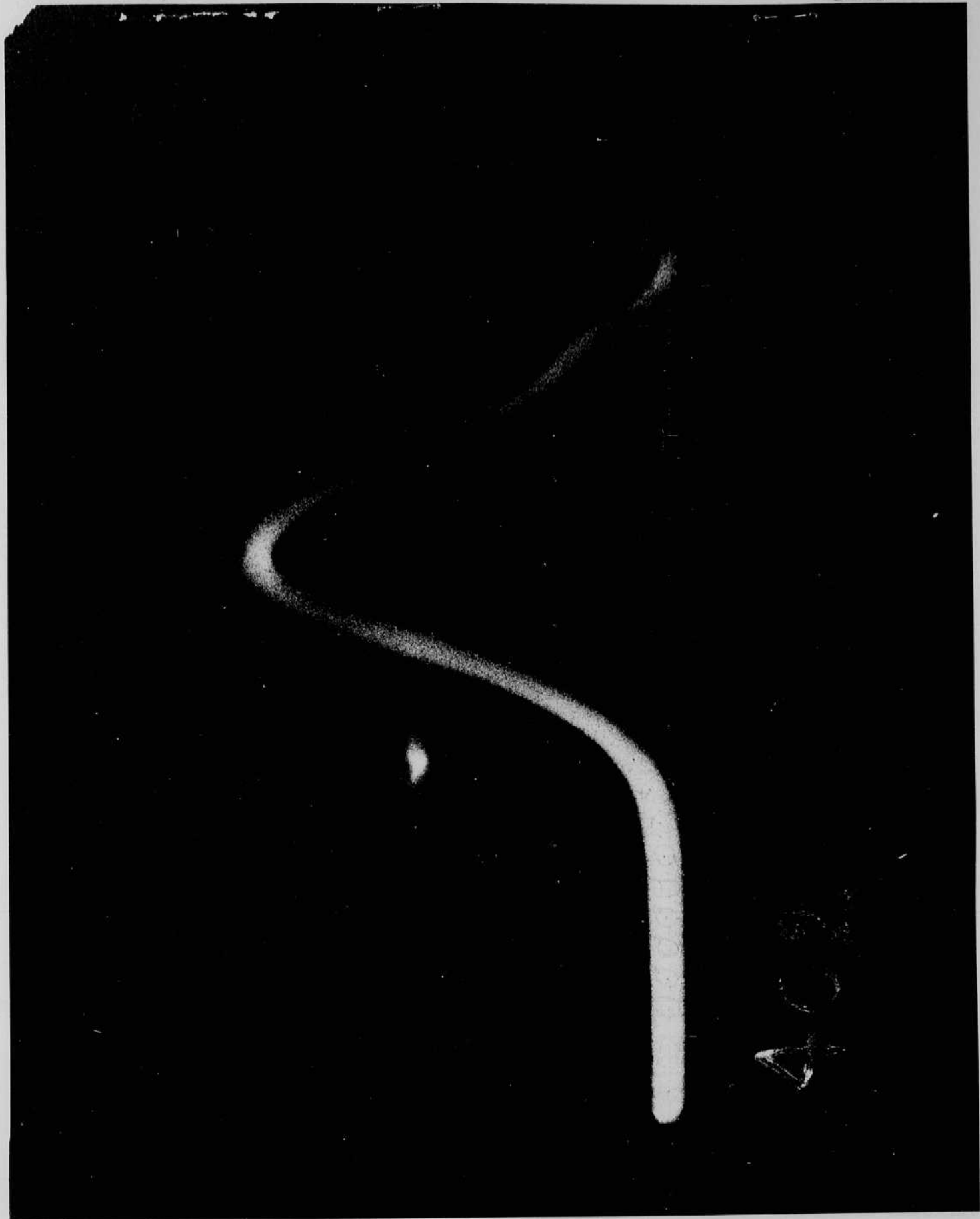

408

57

1/2 30

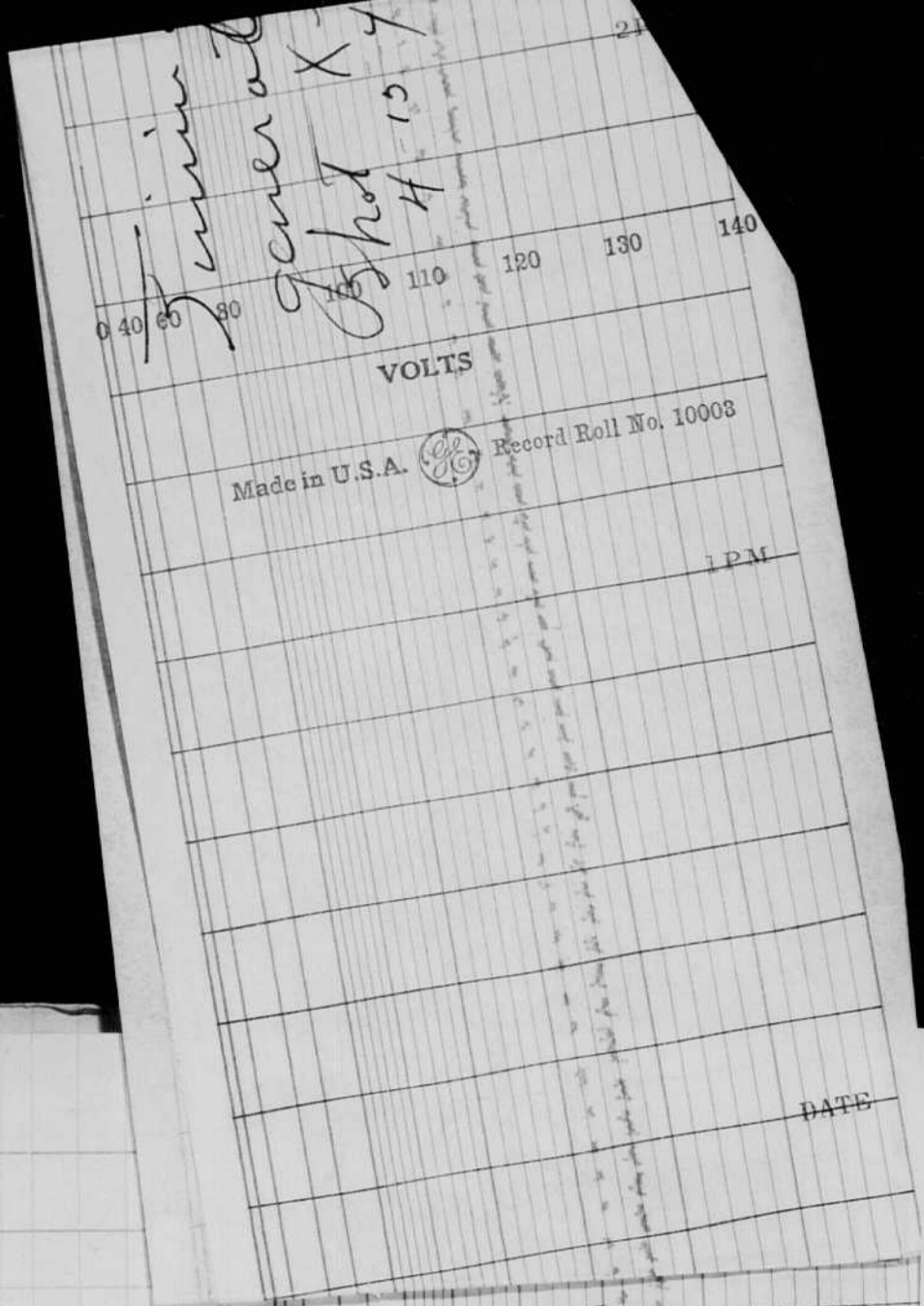

70

f-16 48

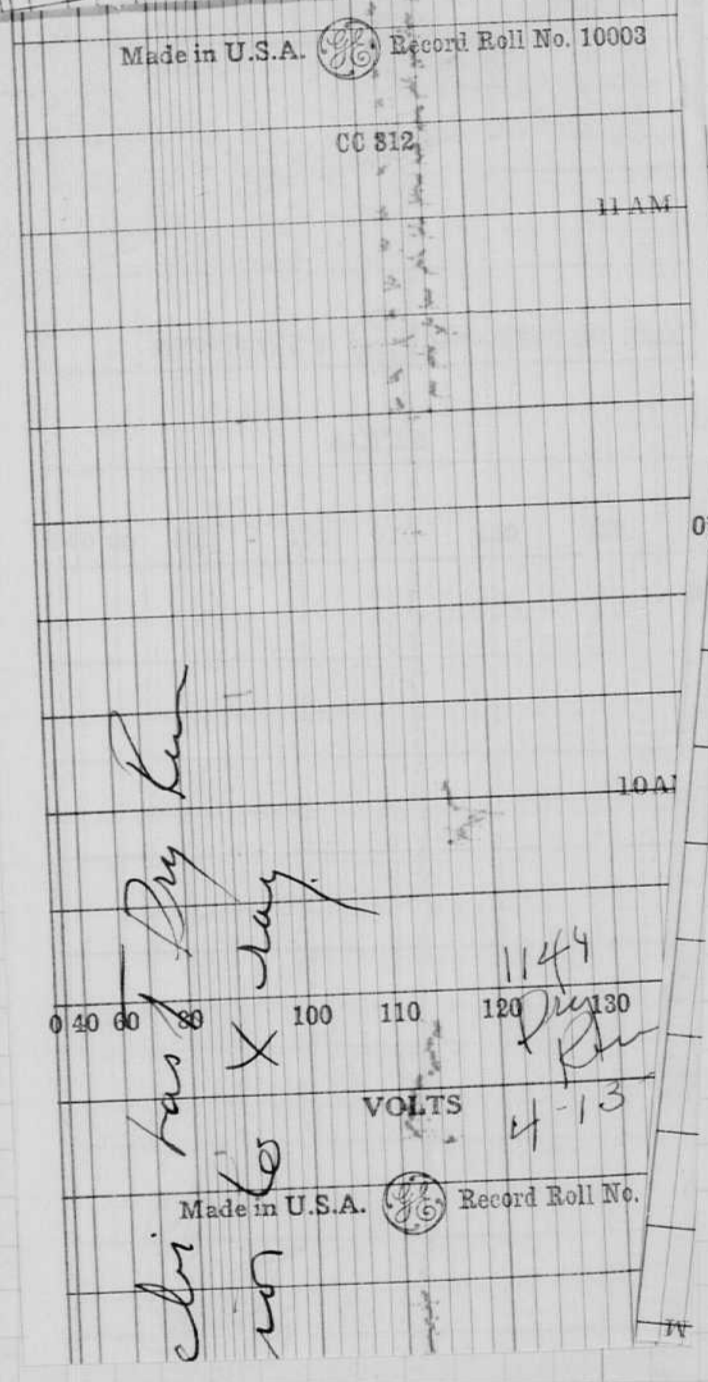
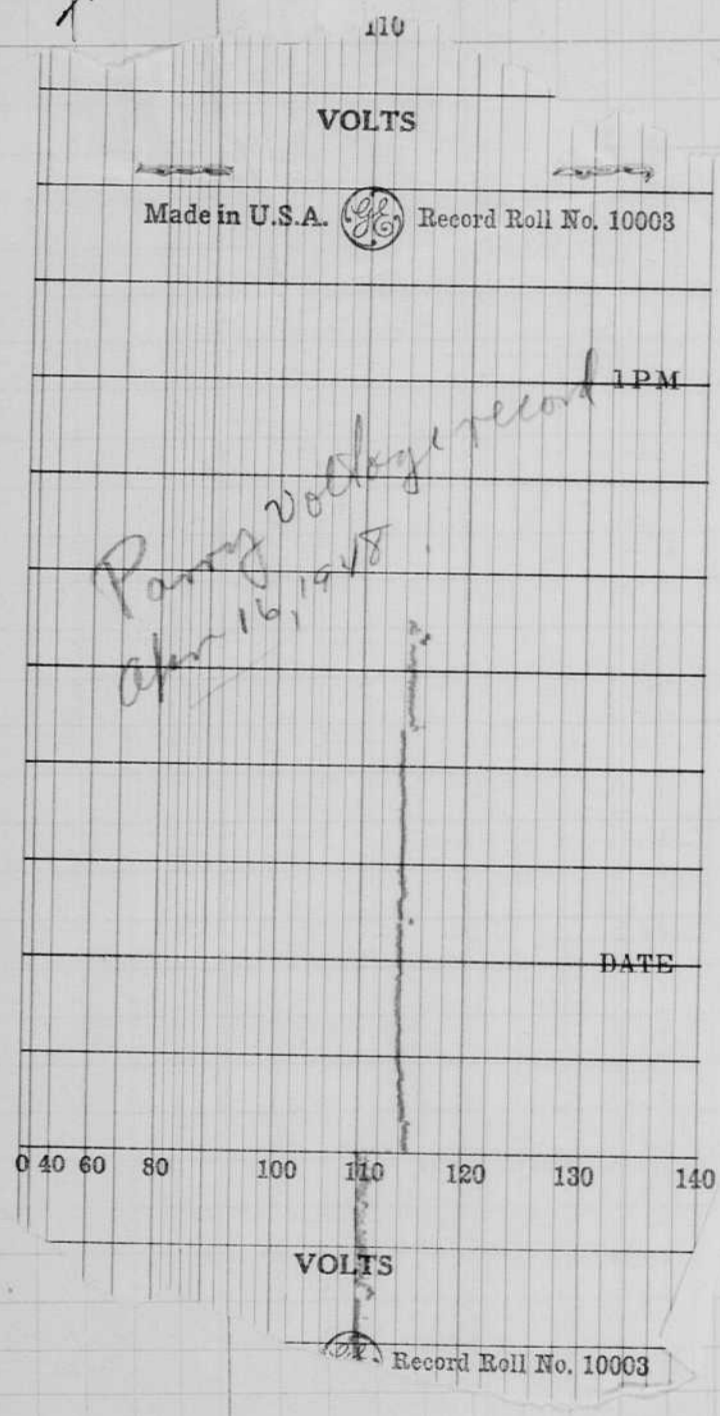

voltage recorder data
X Ray Dry



57 70

70

f-16 4/17

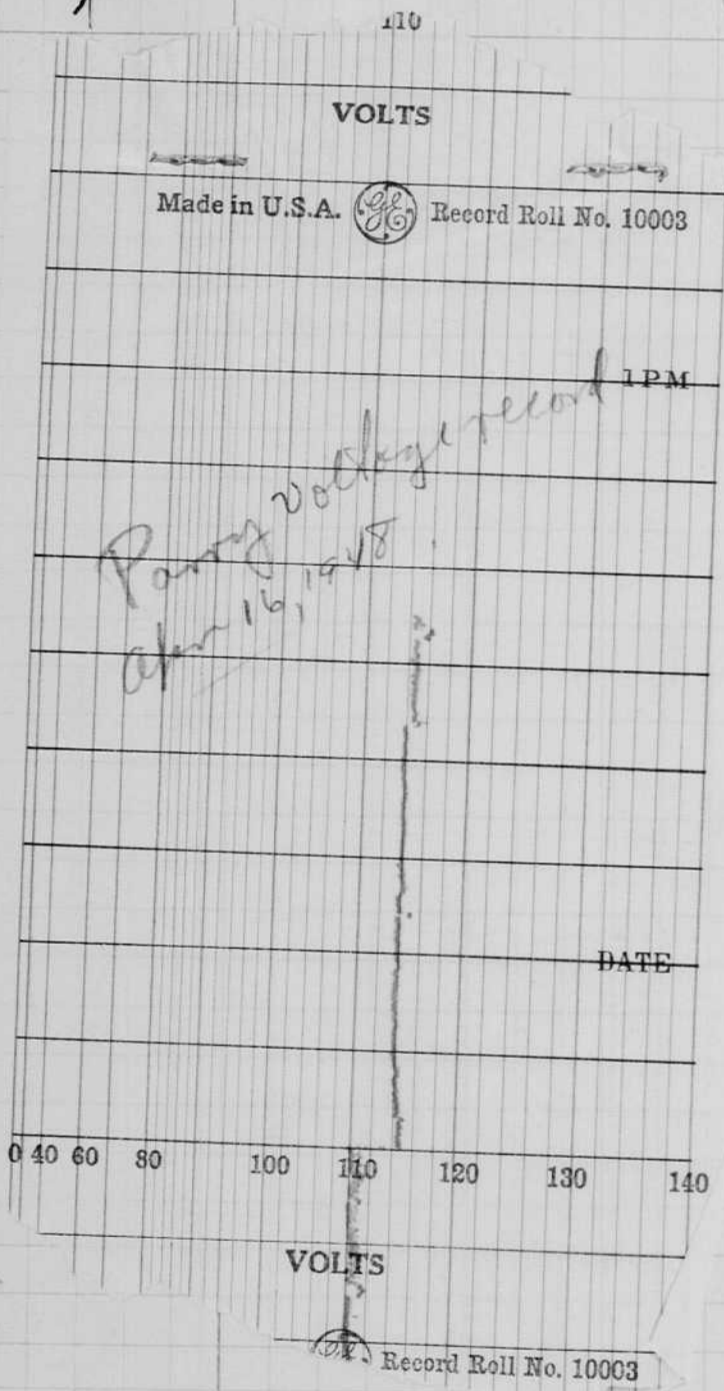

voltage recorder data
X Ray Data

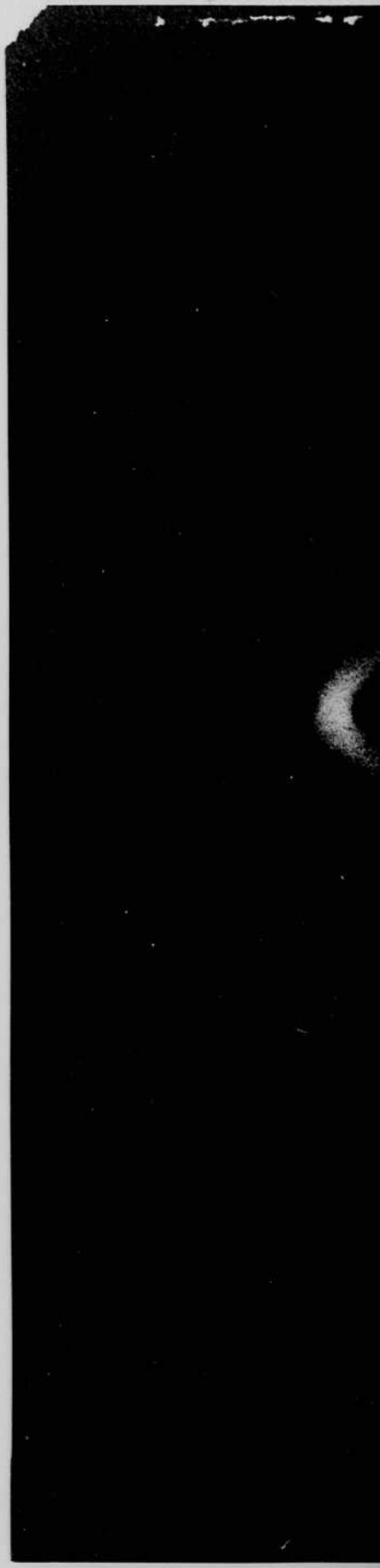

5/17

8-16-48

110

VOLTS

Made in U.S.A.  Record Roll No. 10003

1 PM

0 40 60 80 100 110 120 130 140

VOLTS

 Record Roll No. 10003

DATE

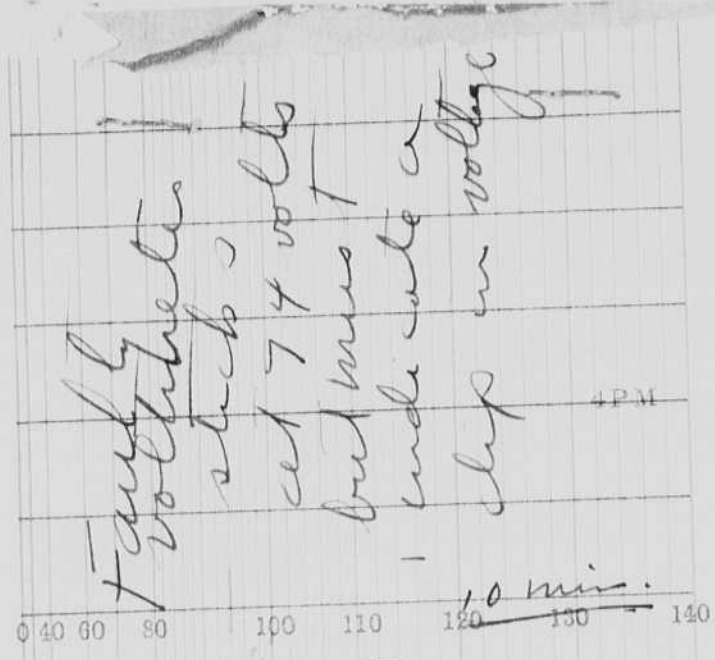

4 PM

VOLTS

Made in U.S.A.  Record Roll No. 10003

Station voltage

3 PM

PN 81557

voltage recorder data

X Ray Day

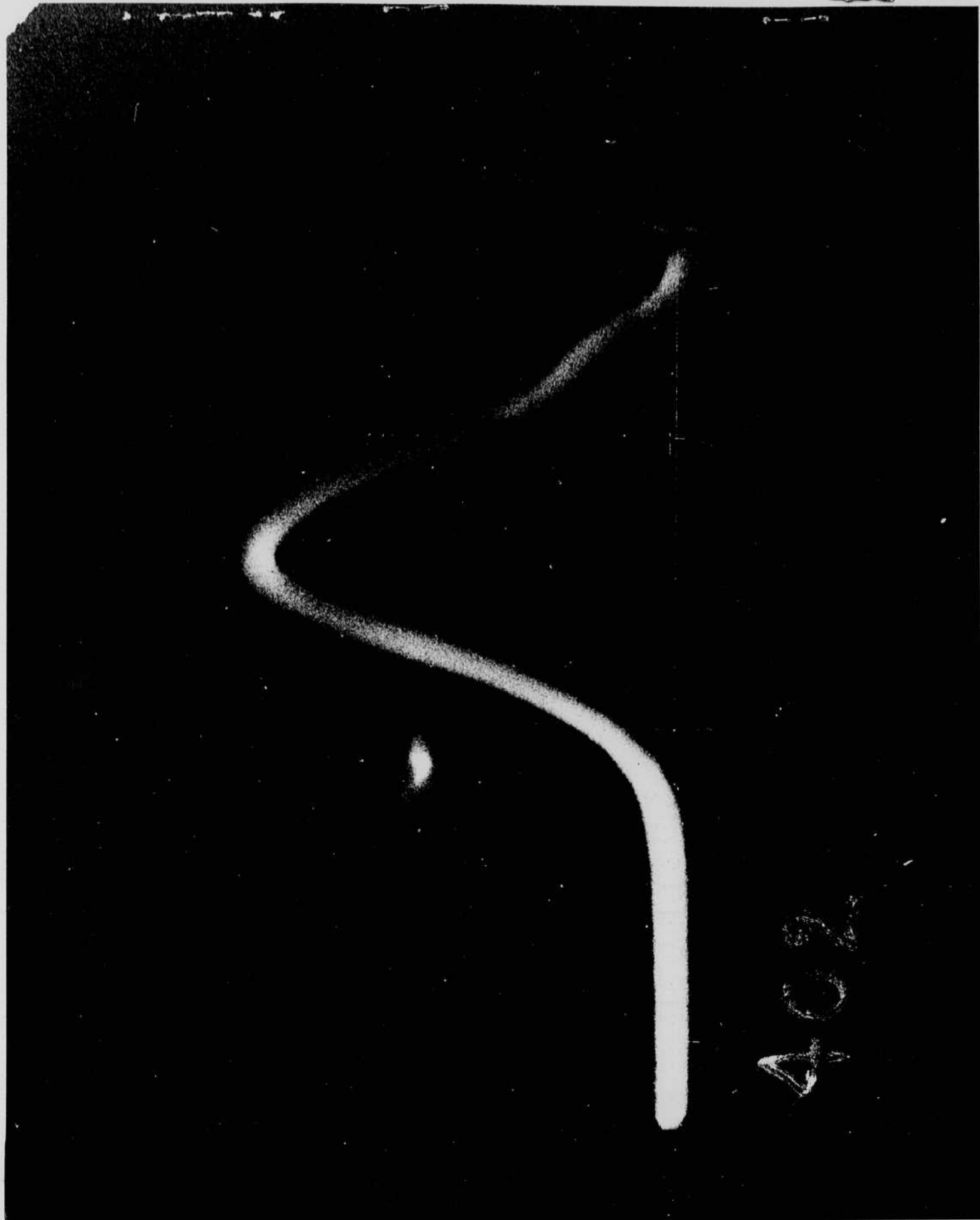

402

570

1/3 20

f-16-48

110

VOLTS

Made in U.S.A.  Record Roll No. 10003

1 PM

0 40 60 80 100 110 120 130 140

10 min.

4 PM

Family voltmeter
check
at 74 volts
but must
- under water a
slip in voltage

VOLTS

 Record Roll No. 10003

DATE

0 40 60 80 100 110 120 130 140

VOLTS

Made in U.S.A.  Record Roll No. 10003

3 PM

Station Eng (L)
to voltage

7 PM 81557

voltage recorder data

X Ray Day

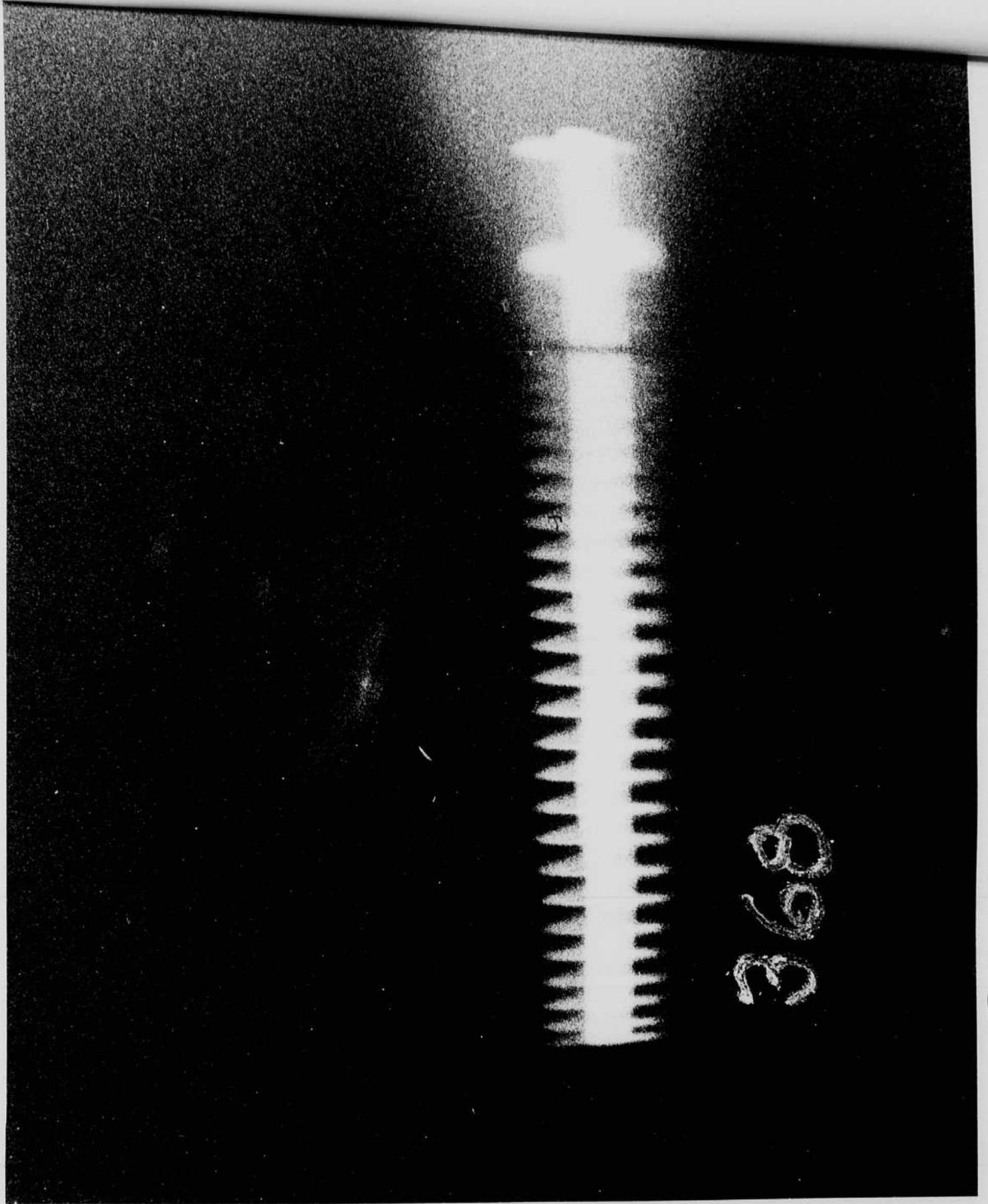

368

Scope 105

S
72

f-16-47

110

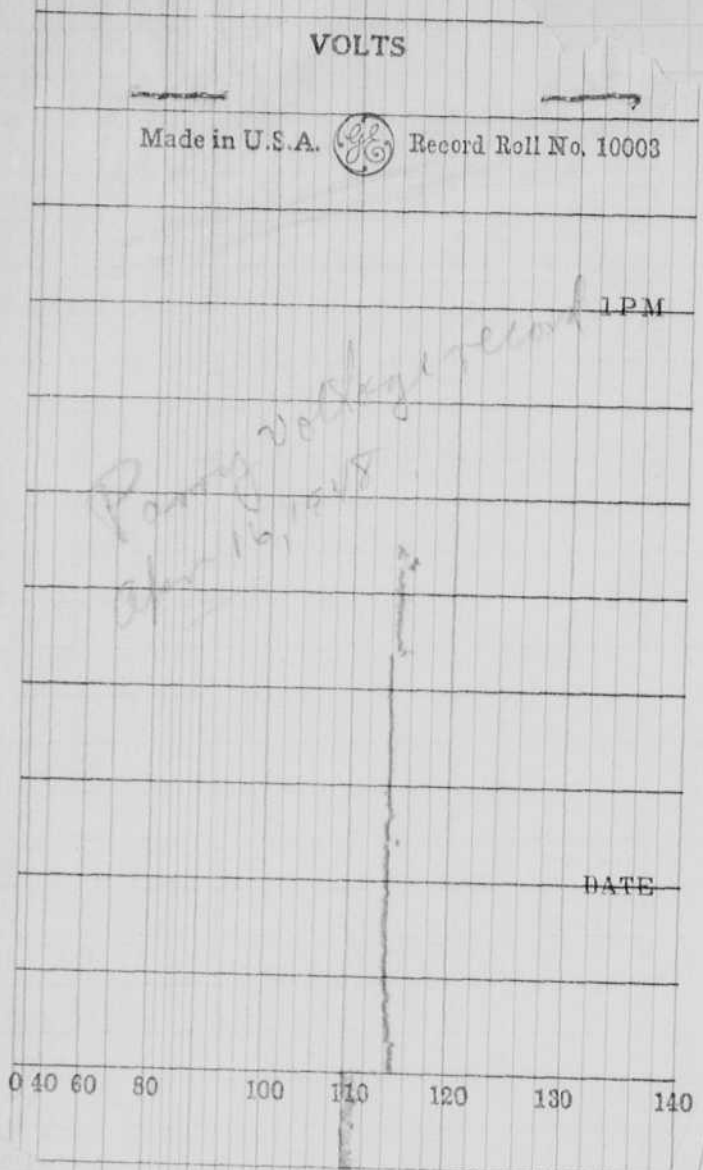

Record Roll No. 10003

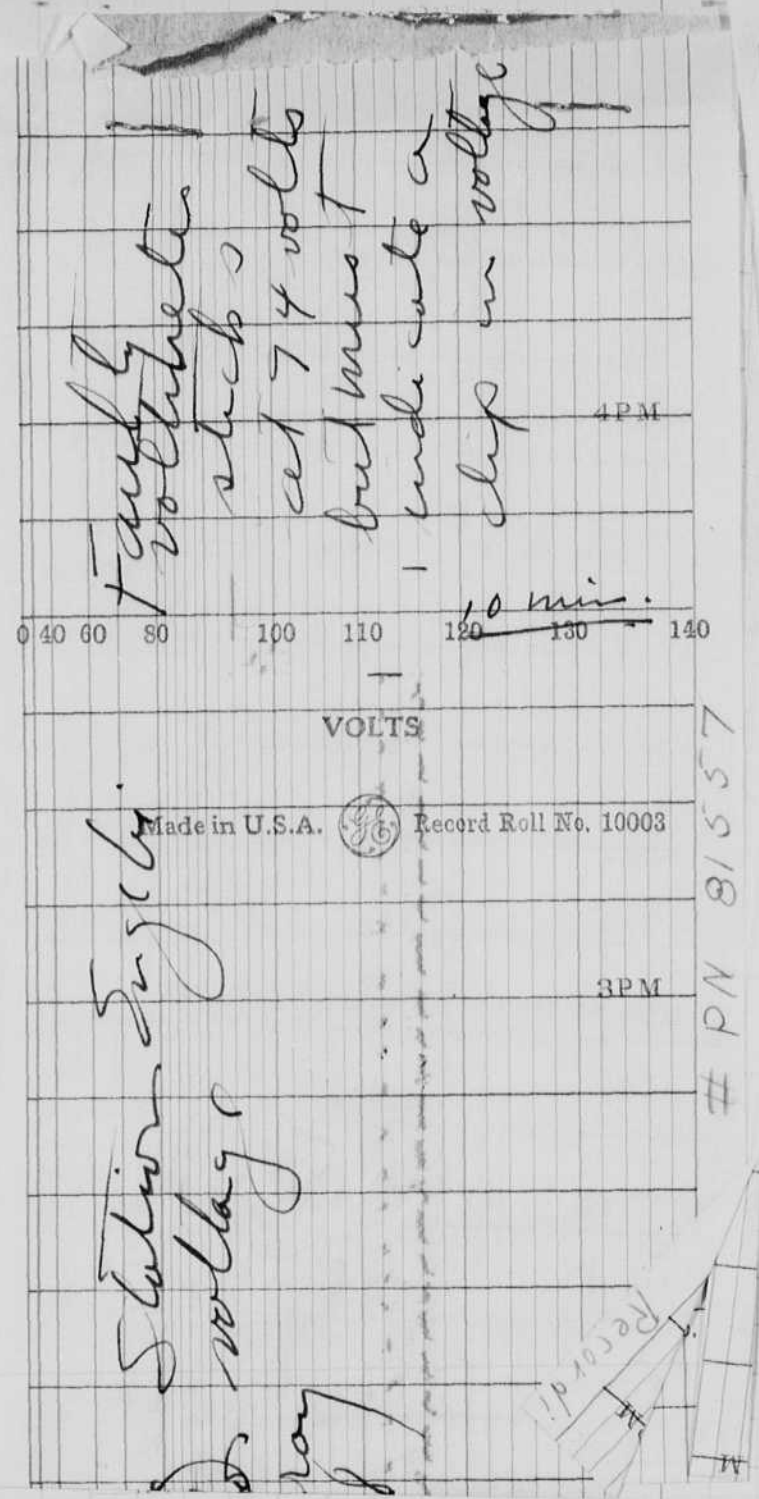

voltage recorder data
 X Ray Data

Scope 105
Film 274

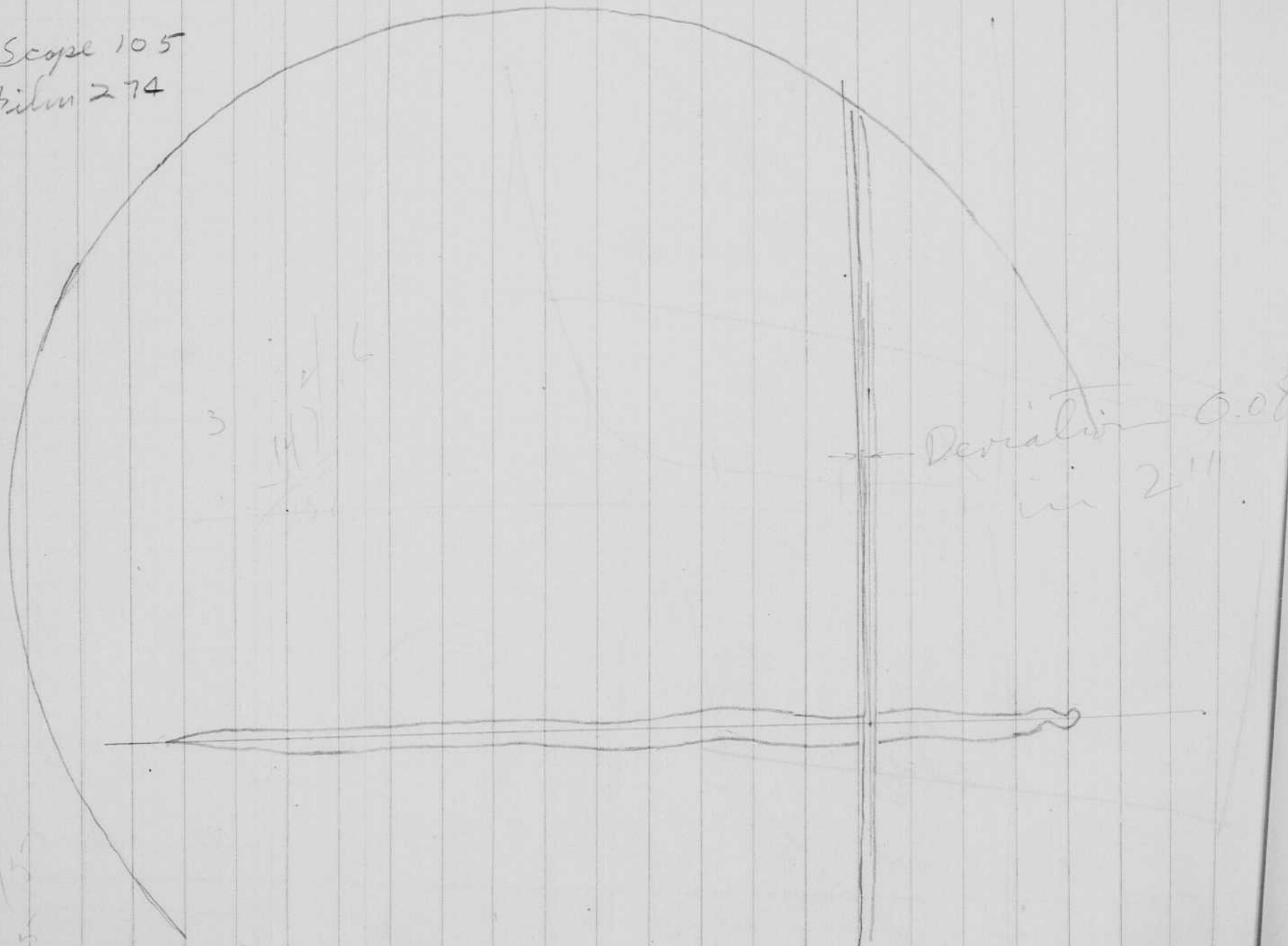

03-01/57

Deviation 0.08
in 2"

voltage

Made in U.S.A. Record Roll No. 10003

VOLTS

100 110 120 130 140

volts
sticks
at 74 volts
but must
indicate a
dip in voltage

4PM

3PM

PN 81557

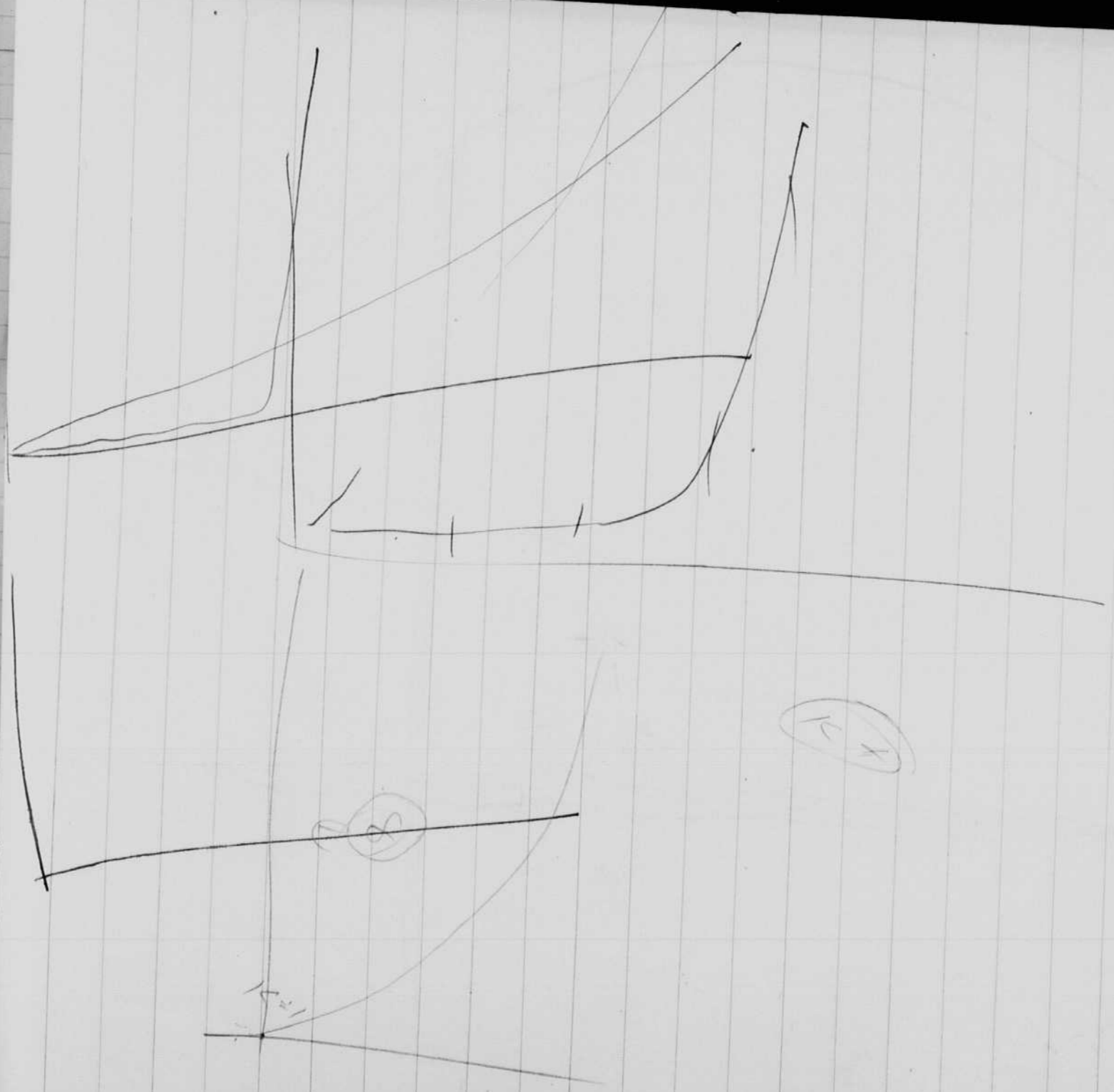

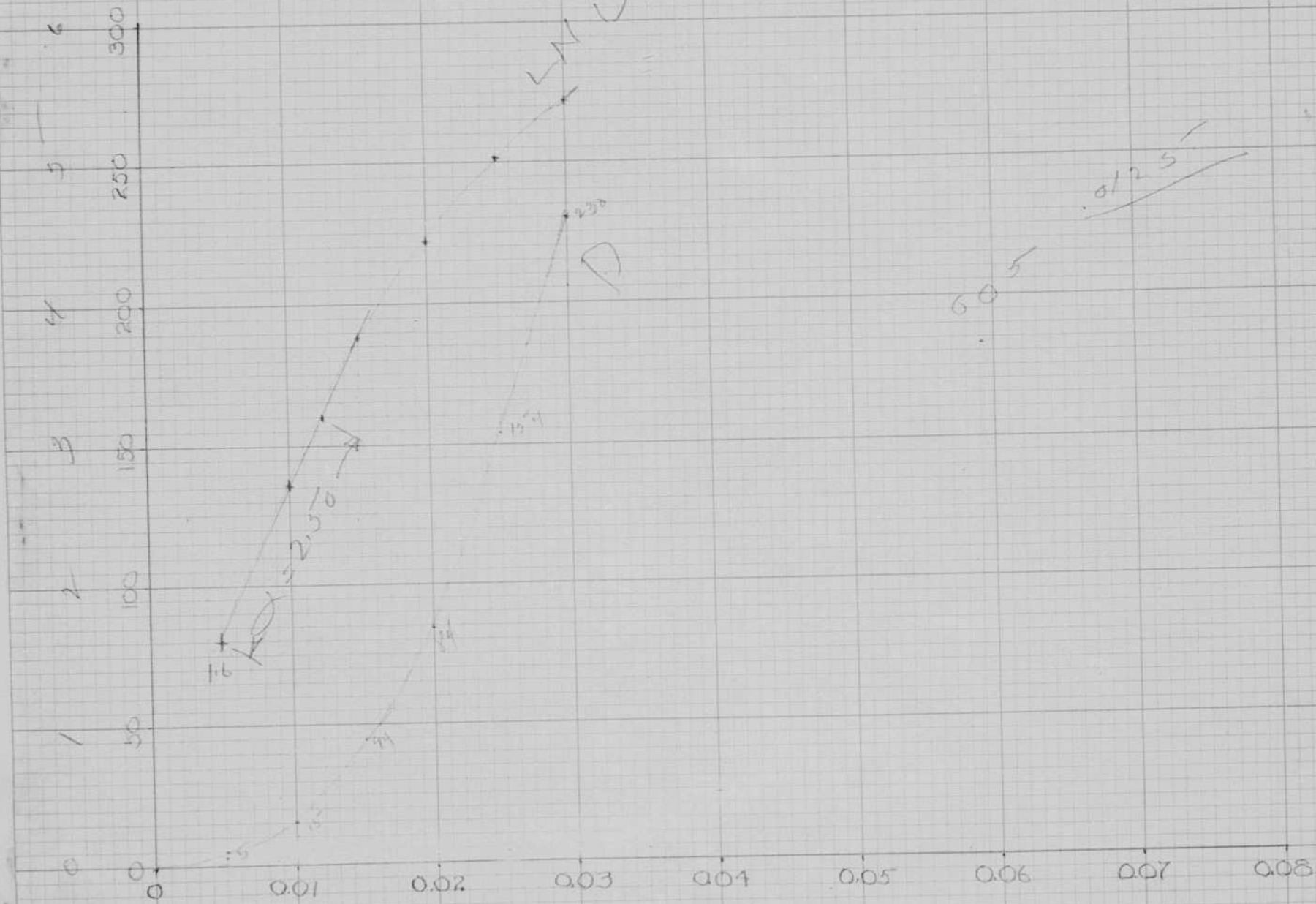

MS Series 4 17 1/8

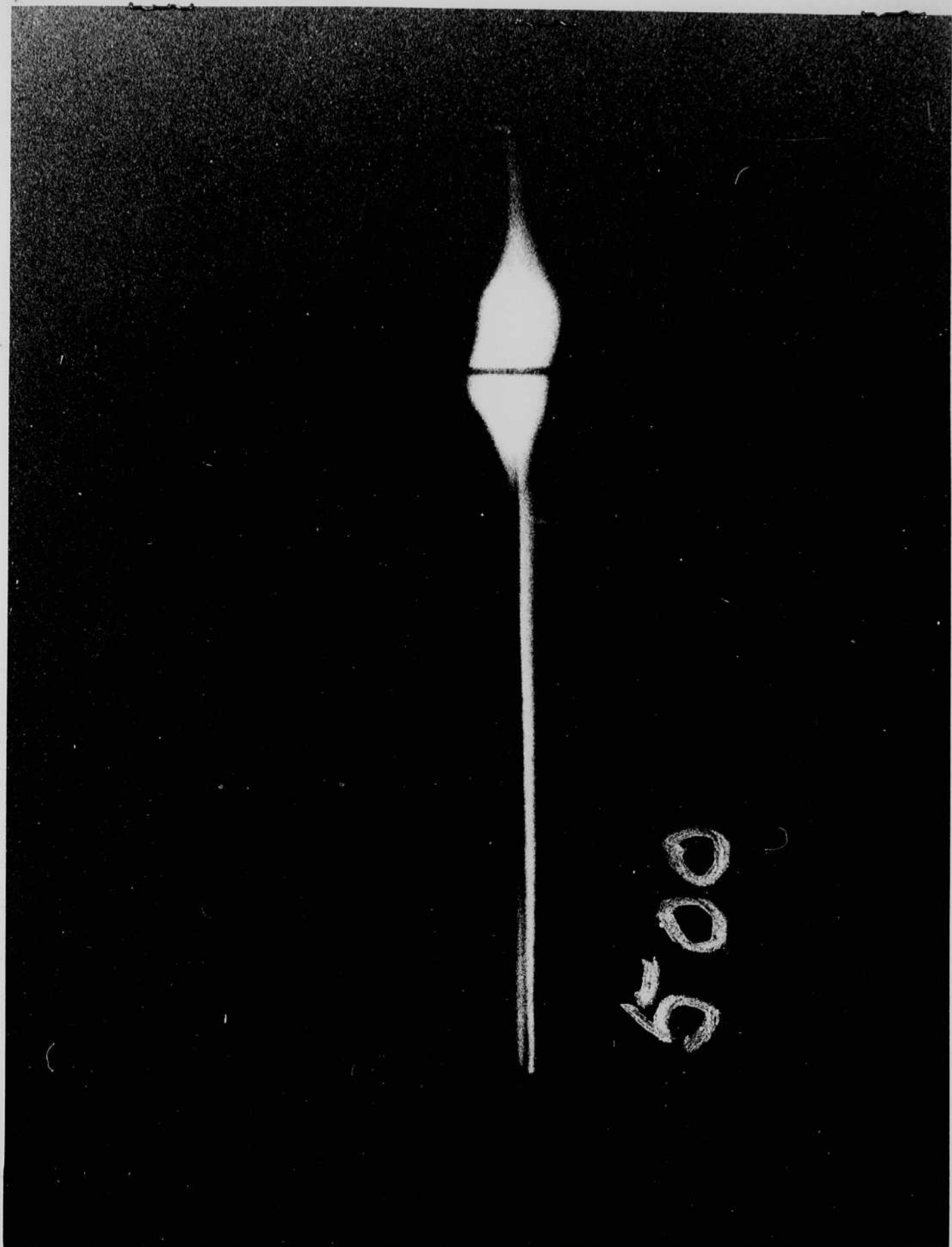

Record from 931 set up on Eugebi with Searchlights.
transit time was o.k. with this intensity time.

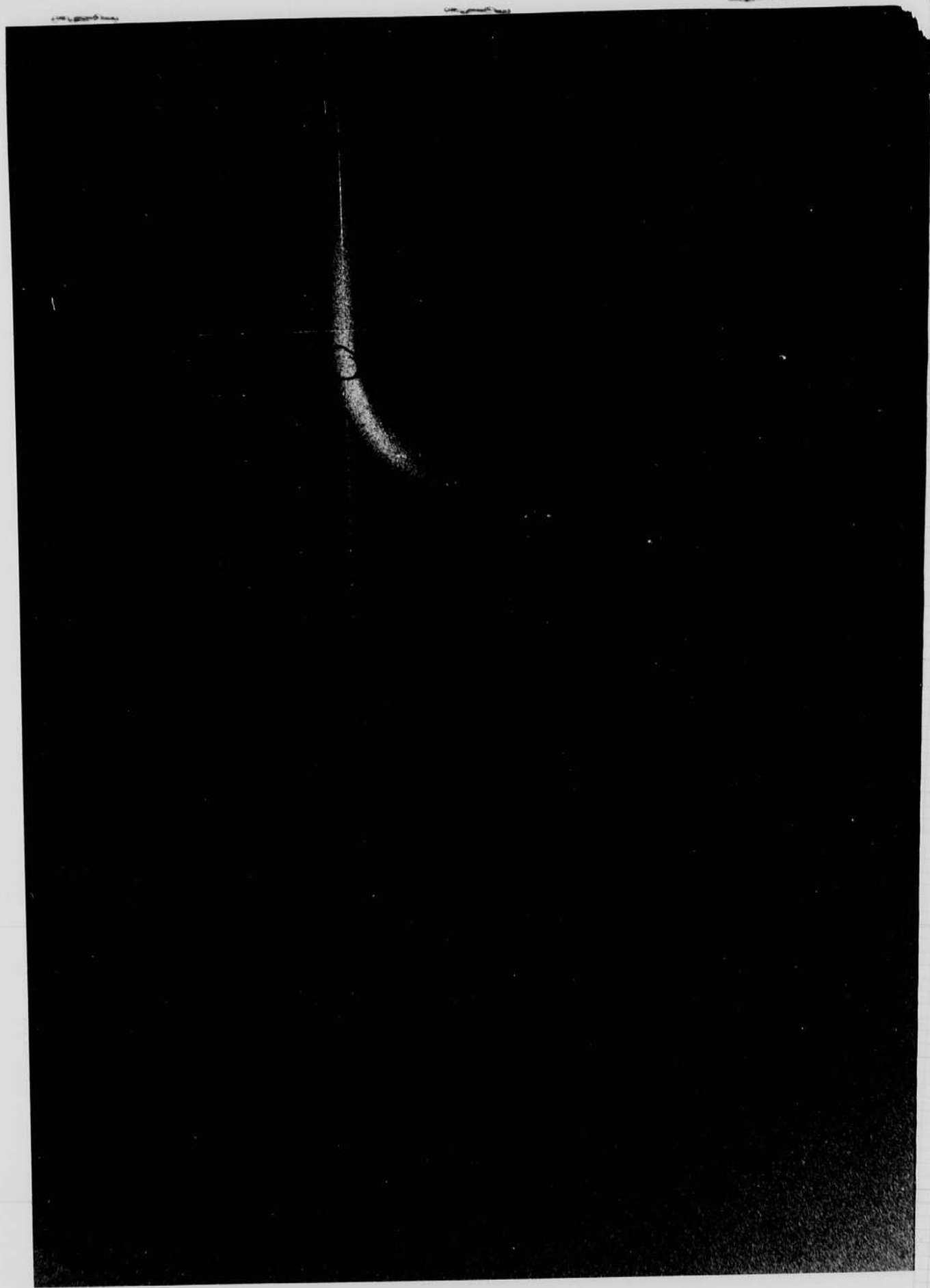

each light.

record from ...
transit time was ok. with this intensity time.



ITS Series 1/1/48

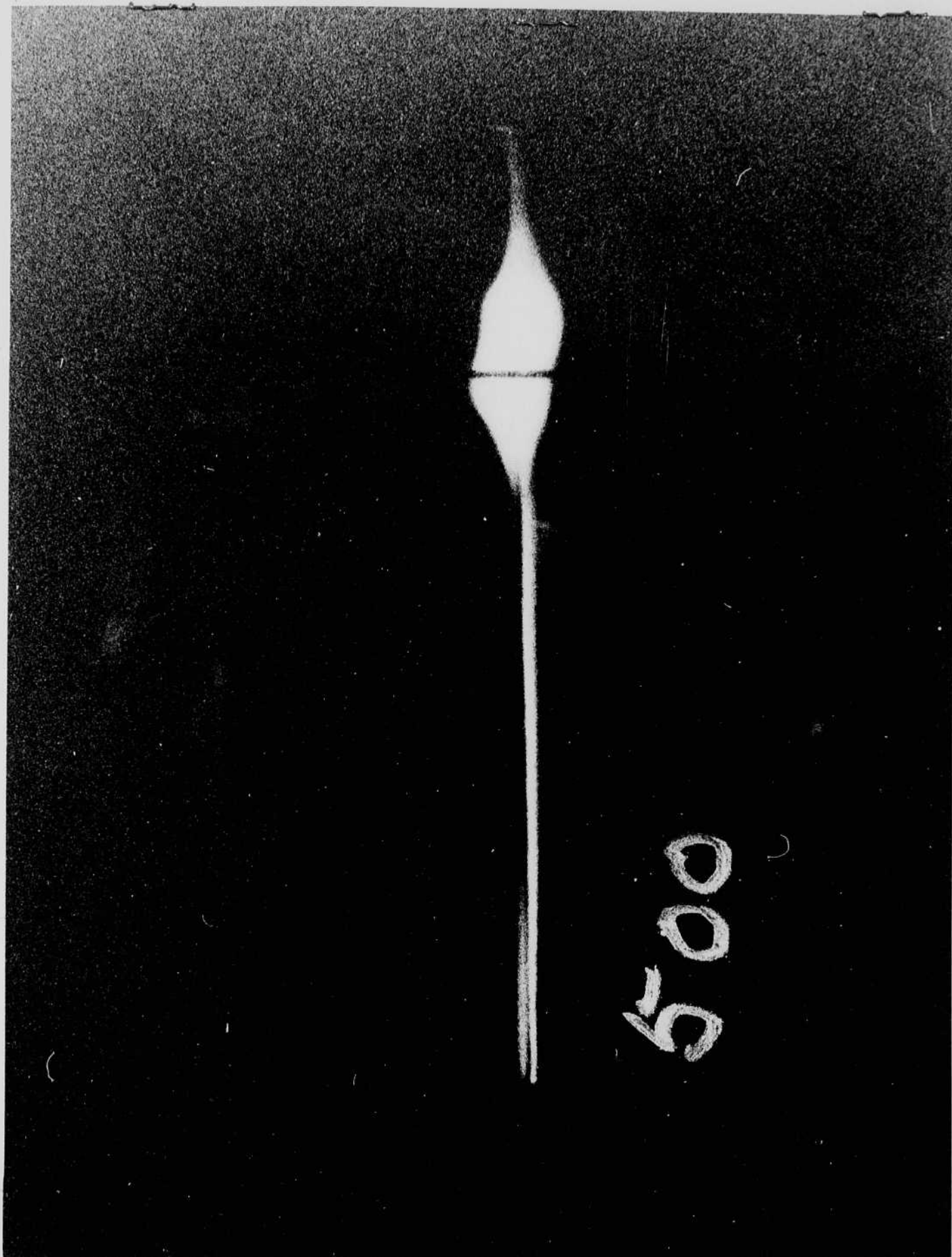

Record from 931 set up on Engelbi with Search lights.
transit time was o.k. with this intensity time.

April 20 1948

Ashore last night on Aomon Island with Sheppard to check out the 935 photocells in the search lights.

(p62)
We used the argon spark at 100 ft but the triggering was marginal. When moved into 70 ft the trigger pulse was ample.

W. Rowan and Bill Taylor assisted with this experiment.

The 931 set up is to be used with naphthalene on Aomon island. We had now increased the load resistor to 2400 ohms and the voltage on the last stage to 500 V. (Apply to Aomon and Runit)
See oscillogram No 468 and 464 (3) for comparison. The new conditions give a larger deflection and a faster rise time.

Transit time Conditions on Engebi

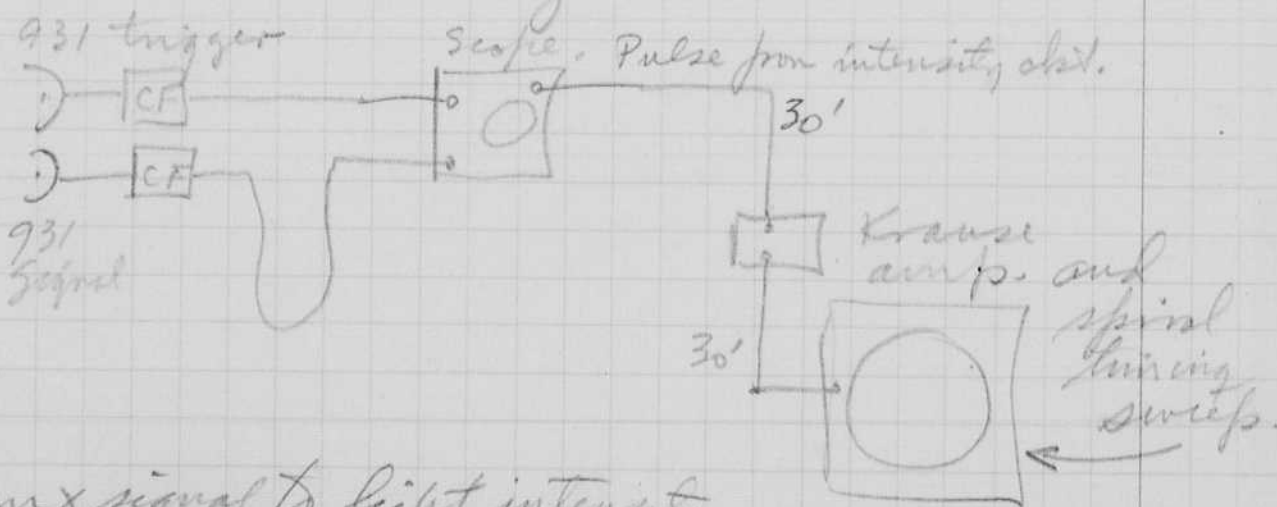

From X signal to light intensity
trip = $115 \mu s \pm$
Person (Los Alamos).
checks OK with Krause data on ionization.

Norris

Apr 23 1948

Sand Elger. USS Albemarle off Damon Island Eniwetok atol.

Electrostatic pickup for use with bomb.

Several experiments indicate that an electric field is present when the bomb explodes. There is no information on when or how this potential is produced.

A metal plate is being tested this morning for use with Bomb no 2 on Damon Island. The plate is of .04" aluminum 10" x 7 1/2" mounted on insulators on a metal chassis 6 x 17 x 4.

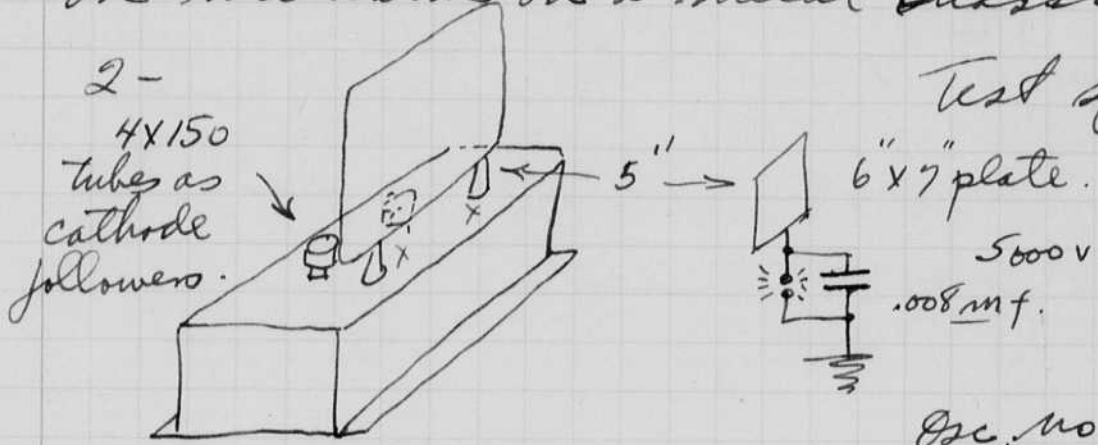

Test sparks.

Osc. no. 504.

505.

were taken with
50 ft in the trip cable
and 125 in the signal.

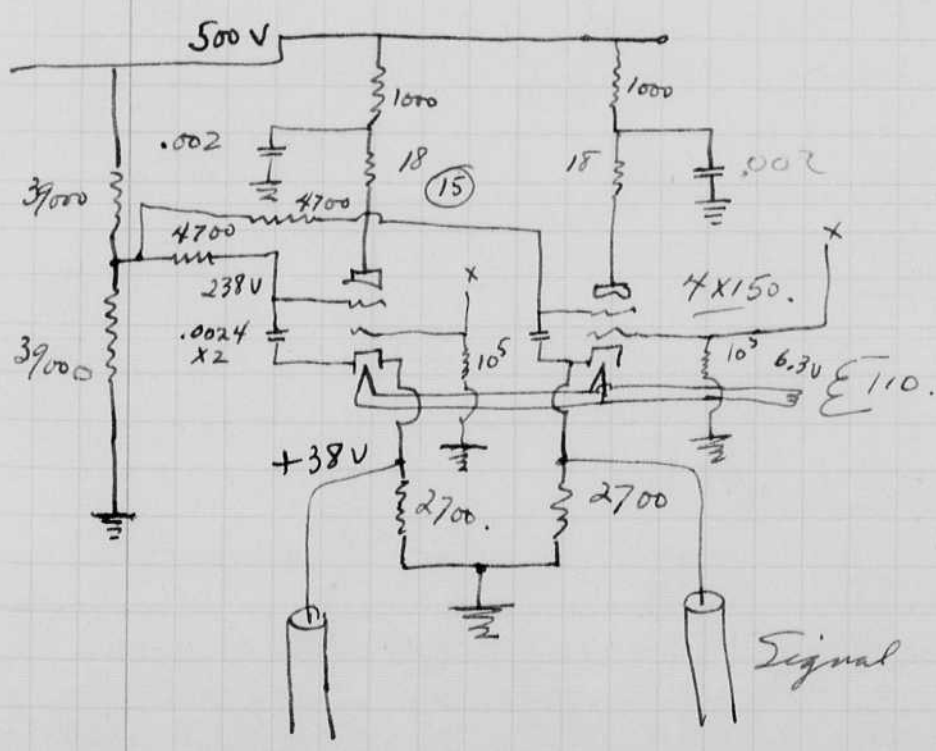

The oscillogram only shows two of positive half cycles. The cathode follower does not give the negative half cycle.

Apr 24 1948
A.S. Edgerton. Comon

Photos PL 546 7-12
547 1

Photo of chassis PM and electrostatic pickup.

The electrical pickup device of p 75 was installed last night with the help of Drake and Rowan. The system was tested with the spark coil out of the stroboscopy triggered gap. p 62.

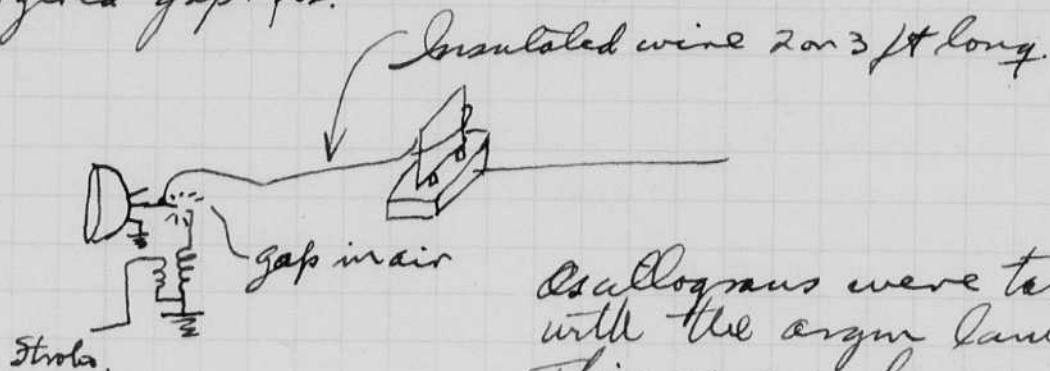

Osullograms were taken with the argon lamp on. This gave a larger signal due to energy from the argon flash.

Circuit as set up in Comon

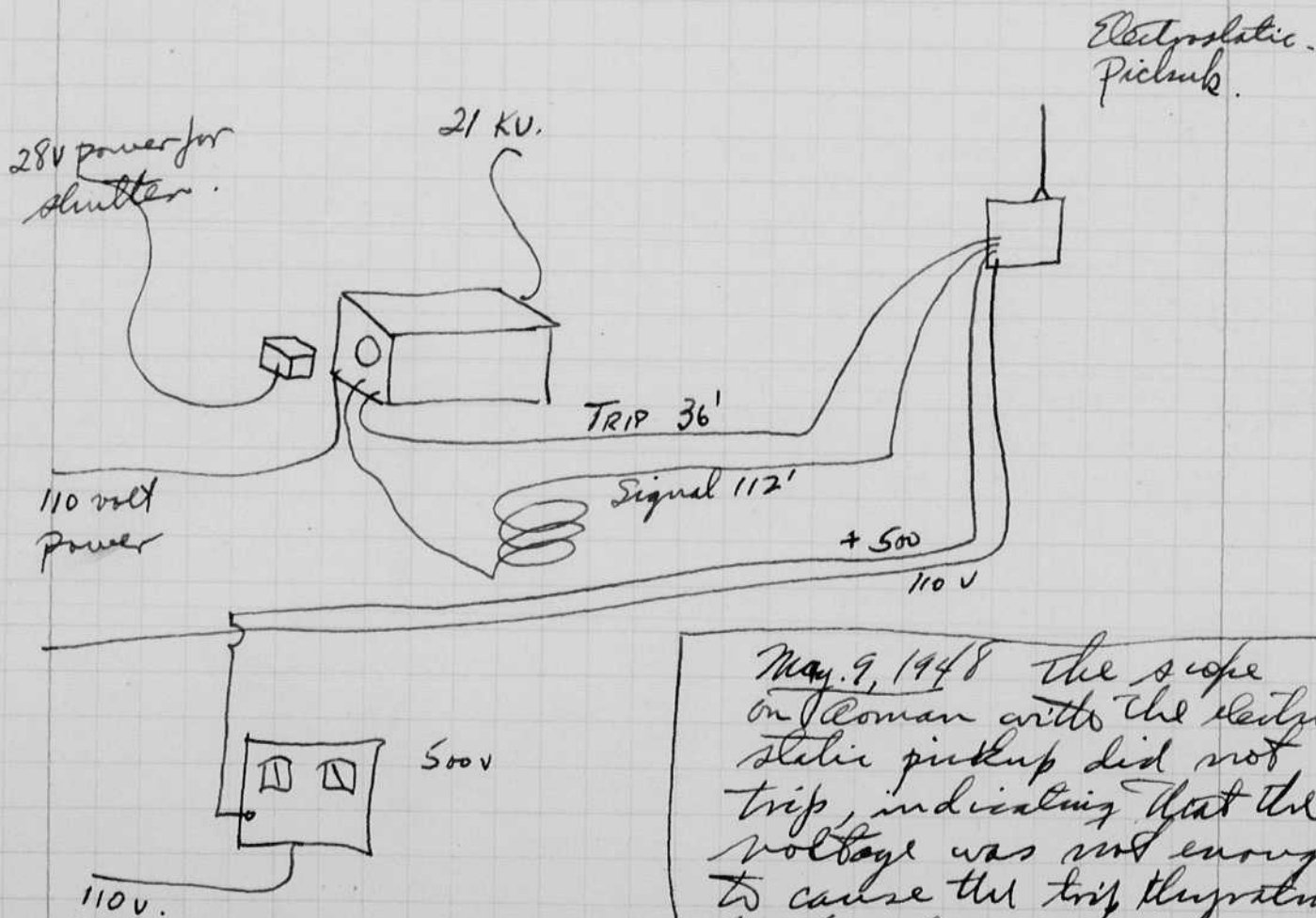

May 9, 1948 the scope on Comon with the electrostatic pickup did not trip, indicating that the voltage was not enough to cause the trip thyatron to operate.

The 931 photo multiplier equipment was tested.

Initial dark current.	Signal -5 μ a	TRIP. 600 jumps
		25 jumps
		2 steady after 5 min.

moonlight (full.)

Tubes covered with boxes that had small slits on the bomb side. 20 μ a 400 μ a jumps.

Naphthalene in beakers for use with the 931 P.M. tubes.



Black tape was put over the outside of the beaker to exclude visual light.

The beaker and glass liner slips over the 931 P.M. tube.

Dark current with tapped beaker over the P.M.

Distance from 1 curie source. to center of P.M. with naphthalene.	-3 μ a	+1 μ a.
30"	-1	+2 μ a.
24"	0	+3.5
18"	2	5.0
12	5	11.
6	19	29
3	70	95.

Gamma Source

1 gram Radium 1 curie
~~3.7~~ 3.7×10^{10} disintegrations per second
 1-2.7 mev.
 \$20,000.
 0.73 R per hour at 1 meter
 0.1 R allowable daily dose.

1 ton TNT has 4.2×10^{16} ergs = 4.2×10^9 joules, Explosion

Dup Chassis Photo tube mounts on
 chassis level, no standoffs.
 Photo tube 935 mounted $2\frac{3}{8}$ " from front of chassis
 4X150 mounted $4\frac{7}{8}$ " from front. U.H.F. Connector
 mtd. 6" from front

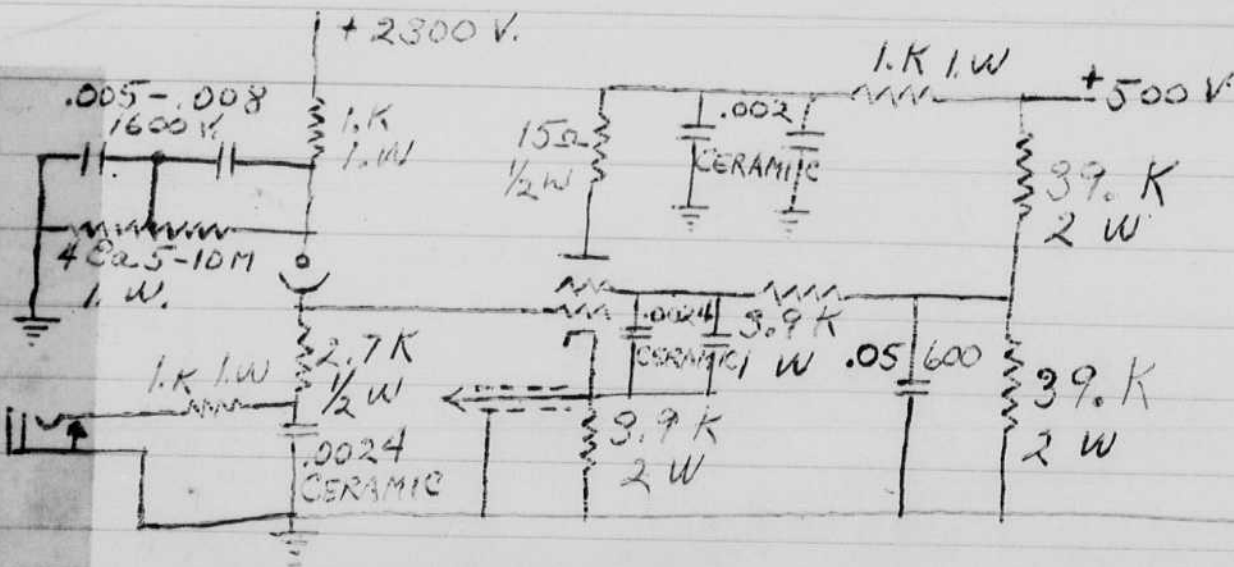
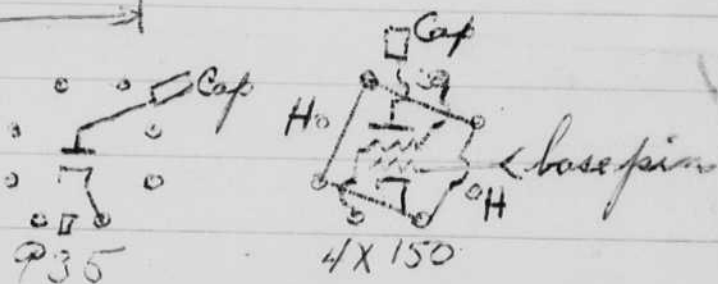
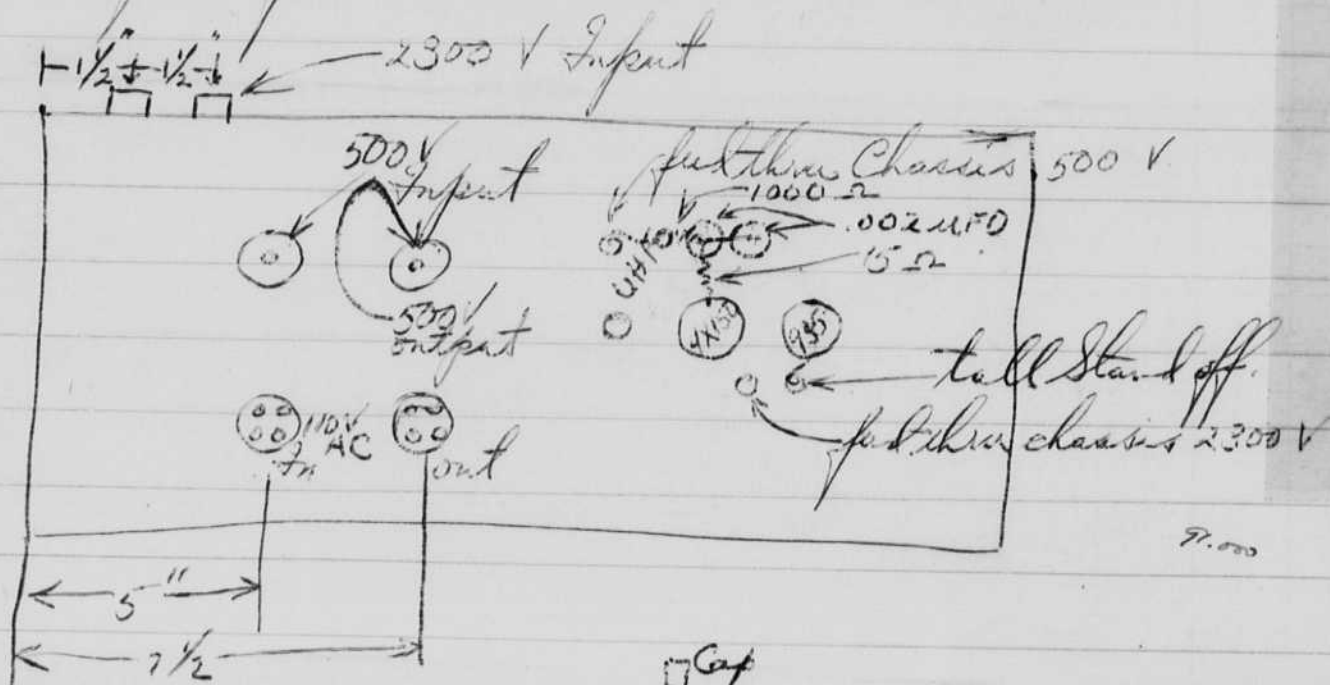

Sunday May 2 1948

Eniwetok Atoll. off Runit Island.

Bomb "yoke" went off according to schedule yesterday morning before daybreak. I was at Parry Island some 11 miles away. There was a distinct odor of ozone at the instant of detonation. The light was terrific followed by a luminous blue glowing cloud that continued to glow for a minute or more as it rose into the air. After 10 minutes or more the trail from the bomb to the top of the cloud appeared as a large Z due to variations in the wind currents. Shortly after the bomb went off there was a white glow on the ground due to heated material. This glow died out after a half minute or less.

Eberhard and I had been at Parry island for several days working on our setup there. The only change from bomb "Xray" was

1. the trip photomultiplier tube was replaced with 931 tube #1. which was more stable.
2. The 931 voltage on the first 9 stages was decreased from 1550. to 1400 v. (Trip Cell only)
3. The diaphragms or irises of the searchlights were only partly open since the moon light was strong. the moon was half and almost directly over head.

470,000 +
110,000 ohms added
in series bleeder

Phase 1 117
2 118
3 115
from recorder
in shelter.

When the equipment at Parry was turned on for the first time each day, the photomultiplier tubes would usually go into a self sustained glow because of the high voltage per stage. It was found that the tubes eventually would stabilize down to a low value of static dark current, sometimes by themselves and sometimes by simply opening the circuit momentarily.

On the morning of the bomb test we went through this procedure several times during the 1/2 hour prior to the shot. The trip P17 tube was particularly bad about the glow

Dup Chassis Photo tube mounts on
 Chassis level to Standoffs.
 Photo tube 935 mounted $2\frac{3}{8}$ " from front of chassis
 4X150 mounted $4\frac{3}{8}$ " from front. U.A.F. Connector
 mtd. 6" from front

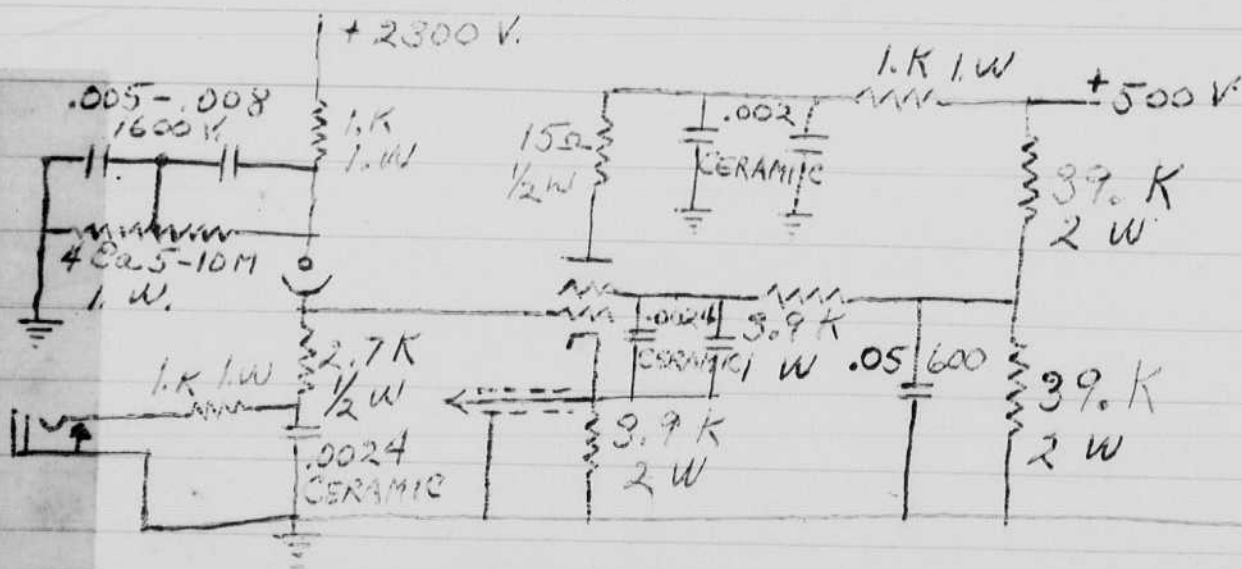
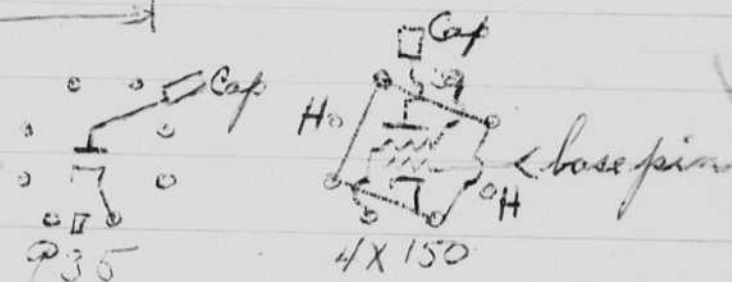
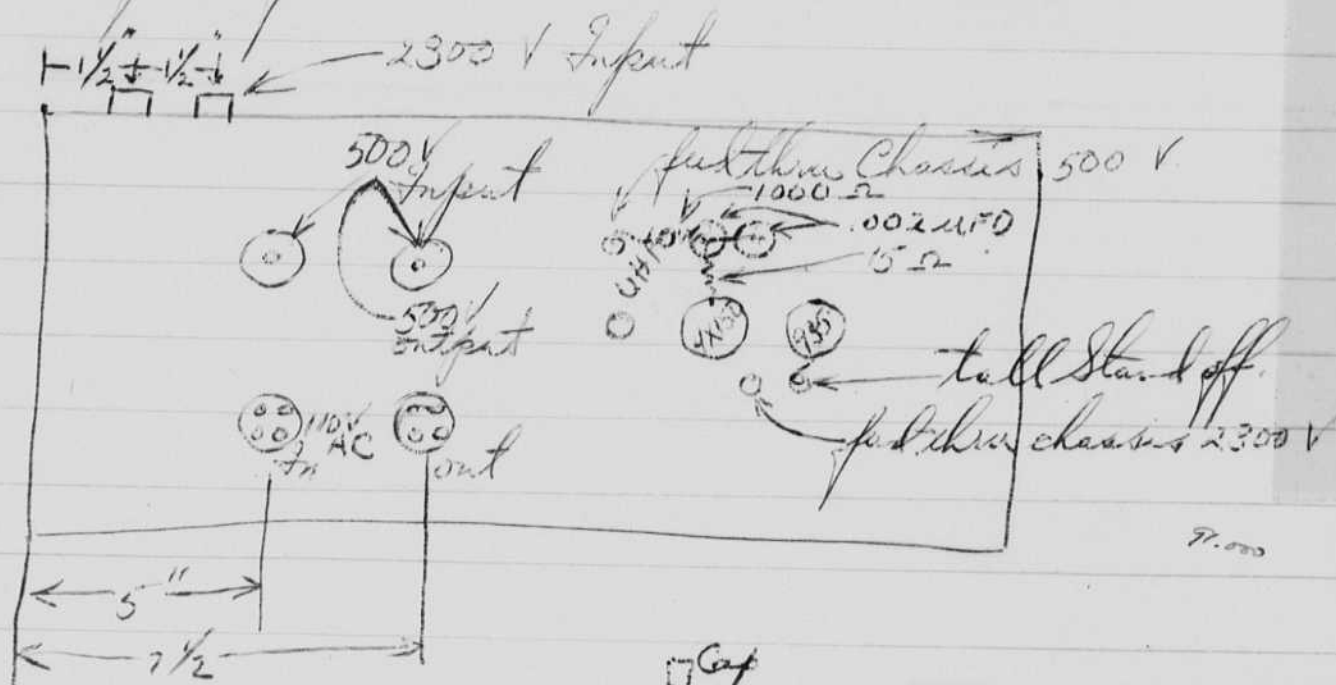

Sunday May 2 1948

Eminelok Atoll. off Runit Island.

Bomb "yoke" went off according to schedule yesterday morning before day break. I was at Parry Island some 11 miles away. There was a distinct odor of ozone at the instant of detonation. The light was terrific followed by a luminous blue glowing cloud that continued to glow for a minute or more as it rose into the air. After 10 minutes or more the trail from the bomb to the top of the cloud appeared as a large Z due to variations in the wind currents. Shortly after the bomb went off there was a white glow on the ground due to heated material. This glow died out after a half minute or less.

Eberhard and I had been at Parry island for several days working on our setup there. The only change from bomb "Xray" was

1. the trip photomultiplier tube was replaced with 931 tube #1. which was more stable.
2. The 931 voltage on the first 9 stages was decreased from 1550. to 1400 v. (Trip Cell only)
3. The diaphragms or irises of the searchlights were only partly open since the moon light was strong. The moon was half and almost directly over head.

470,000 +
110,000 ohms added
in wire bleeder

Phase 1 117
2 118
3 115
from recorder
in shelter.

When the equipment at Parry was turned on for the first time each day, the photomultiplier tubes would usually go into a self sustained glow because of the high voltage per stage. It was found that the tubes eventually would stabilize down to a low value of static dark current, sometimes by themselves and sometimes by simply opening the circuit momentarily.

On the morning of the bomb test we went through this procedure several times during the 1/2 hour prior to the shot. The trip P17 tube was particularly bad about the glow

condition when the iris was opened, I went up to 100 μa from the (1 μa) static dark condition several times without incident, but if the current was held at 50 for a minute or so it might suddenly go to a large value, that is off scale on the 100 μa range. On one test I found that it was off scale on the 1000 μa range.

On the morning of the Yoke Bomb drops on the roof of the control station with St. Gilbert We opened the iris so that 40 μa resulted from the moon light and early day light.

at the -30 second going the meter went off scale (100 μa). I debated whether I should go down below to open the circuit or to take a chance on the tripping. I decided the later because of time. Fortunately the trigger did work even if blocked and two good oscillographic records were made by the signal P.M. tubes that were on the stand back of the control station. Eberhard kept the irises of these so that the current was about 150 μa on each. The iris for this was open some $\frac{1}{10}$ to $\frac{1}{2}$ of the full reading.

The records at Parry were O.K., showing an α of about $1. \times 10^8$

Aomon Island

Equipment was arranged on Aomon island at the 1300 yard timing station. This shelter is constructed of 18" thick concrete, a lead walled coffin is inside with 2' thick walls. Sand is piled against the shelter, flush with the top giving an additional 20 or 30 ft thickness of sand.

1. Visual light. Two 36" D.E. searchlights were placed at the 1300 yard station on the roof with the sights focussed on the bomb house 200 ft above the ground. Each searchlight had a 935 phototube at the focal point.

There was a hole melted in the screen over the cathode of the P.M. tube. Trigger.

Notebook # 18

Filming and Separation Record

___ unmounted photograph(s)

___ negative strip(s)

2 unmounted page(s)
(notes, drawings, letters, etc.)

was/were filmed where originally located between page 80 and 81.

Item(s) now housed in accompanying folder.

condition when the iris was opened. I went up to 100 μ a from the (1 μ a) static dark condition several times without incident, but if the current was held at 50 for a minute or so it might suddenly go to a large value, that is off scale on the 100 μ a range. On one test I found that it was off scale on the 1000 μ a range.

On the morning of the Yoke Bomb drops on the roof of the control station with St. Gilbert We opened the iris so that 40 μ a resulted from the moon light and early day light.

at the -30 second going the meter went off scale (100 μ a). I debated whether I should go down below to open the circuit or to take a chance on the tripping. I decided the later because of time. Fortunately the trigger did work even if blocked and two good oscillographic records were made by the signal P.M. tubes that were on the stand back of the control station. Eberhard kept the irises of these so that the current was about 150 μ a on each. The iris for this was open some $\frac{1}{10}$ to $\frac{1}{2}$ of the full reading.

The records at Parry were O.K., showing an α of about 1×10^8

Aomon Island

Equipment was arranged on Aomon island at the 1300 yard timing station. This shelter is constructed of 18" thick concrete, a lead walled coffin is inside with 2' thick walls. Sand is piled against the shelter, flush with the top giving an additional 20 or 30 ft thickness of sand.

1. Visual light. Two 36" D.E. searchlights were placed at the 1300 yard station on the roof with the sights focussed on the bomb house 200 ft above the ground. Each searchlight had a 935 phototube at the focal point

There was a hole
melted in the screen
over the cathode of the
P.M. tube. Trigger.

Notebook # 18

Filming and Separation Record

___ unmounted photograph(s)

___ negative strip(s)

2 unmounted page(s)
(notes, drawings, letters, etc.)

was/were filmed where originally located between page 80 and 81.

Item(s) now housed in accompanying folder.

Exp 11 had a 935 photo tube at the focal point

Perry Setup for Bomb Y.
April 28 1948.

3- 36" Searchlights with 931 photo multiplier tubes

Trip photo multiplier on roof of control station.

1400v on dynodes 11-9 350 - dynode 9-10

Cable length to two scopes in parallel

on input = "

Signal photo multiplier tubes. (Same tubes as used
for Bomb X test).

East Searchlight into scope 106.

West Searchlight into scope 105.

Signal cables about "

Signal search lights about 30' back of trip.

1400
500
1cm
2400

Scope

Handwritten notes at the top of the page, possibly a title or date, which are mostly illegible due to fading and bleed-through.

3-21-2008

Handwritten notes in the upper middle section of the page, including a date and some descriptive text.

Handwritten notes in the middle section of the page, including a date and some descriptive text.

Handwritten notes in the lower middle section of the page, including a date and some descriptive text.

Exp 1 had a 935 photo taken at the focal point

Setup for Comora Island.
April 25 1948
Bomb Y.

1. 36" Searchlights with 935 phototubes and 0.17 μ s. sweep. 30' trip cable. 120' signal.
2. 931 photomultipliers 1400 volts 11-9 dynode.
500 volts 9-10 dynode. Naphthalene in beakers over the photomultipliers, thickness of naphthalene about 1 cm. Sweep time 0.17 μ s.
31' 2400 ohms 500 volts last stage.
3. Electrostatic pickup unit with metal plate 7" x 10" perpendicular to bomb. Two C.F. tubes for trip and signal. Trip length "
Signal length "

4. All three record negatives have zero traces displaced downward by 40 volts

$\frac{40}{1500}$

1400 V 11-
500 V 9-1
1 cm naph
2400 ohms

Scope 122

Step for ...
...
...

...
...

...
...

...
...

...
...

...
...

...
...

...
...

...
...

light had a 935 procedure at the ...

of the mirror, in fact slightly back of the focal point so that the image of a lamp on the house would throw a circle of light about $\frac{1}{2}$ " on the 935 photocell cathode.

A Dumont scope no. 121 type K 1013 was used to record the transient voltage on a 0.17 μ a (approx) sweep. Timing records of the scope speed had been taken previously.

The above combination gave an excellent trace that shows α to be about 1.2×10^7 on the first analysis. Krause shows about $.85 \times 10^8$ on this ionization chamber. Apparently the light shows a greater α than the ionization? Further data will undoubtedly be inserted in this book later. See page _____.

2. Light in Naphthalene from Gamma Rays.

1400 V 11-9 dynode.
500 V 9-10 "
1 cm naphth.
2400 ohms.

Two photo multiplier tubes with naphthalene were located in a house on top of the timer station at Aoman. A calibration of the naphthalene is given on page 77. One tube was used to trigger Dumont scope no 119 type K 1013 while the other was used to supply a signal to the plates. Both PM tubes fed directly to 4X150 tubes and to 100 ohm lines. The circuit terminated in an open circuit on the plates. No transformer (RCA line type) was used for either scope at Aoman.

3. Electrostatic pickup page 76 - no record. Sweep did not trip.

A successful record was made which on first analysis showed $\alpha = .85 \times 10^8$ thus checking Krause's figure.

For the last few days there has been much discussion of these results, especially the ones concerning light. All three light records show α to be larger than obtained from the ionization chamber method of Rossi.

In conf. with Grier, Egle, Gherhard and myself it was decided to set up the following on Dumont.

H. G. Egerton
May 3, 1948.

Proposed Runit Setup.

1. Visual light 935 phototubes in 36" searchlights. (Same as Aoman).
2. Light from Naphthalene measured by 931 P14 tubes. (Same as Aoman).
3. Light from Naphthalene measured by 935 phototubes. This measurement will be a repeat of test made at Eugebi which was unsuccessful. Trigger will be obtained from the case 2 above.

Conditions at Parry.

A 935 will be substituted for one of the 931 tubes now in use. At this position the 935 signal will be about $1/1000$ that of the one in the searchlight at Runit.

May 6 1948. I have been on Runit Island for the past few days finishing the set up in the timing station.

Calibration of signal searchlight with 935 tube.

no. 1000 watt lamps on tower Voltage μ a.

0	-	.05
3	143	.14
6	120	.18
9	100	.12
9	115	.20

(.25).

Further data taken May, 7. Will Rowen Consider.

0	0	.06 μ a.
3	150	.16
6	150	.28

D.C.
Bulb
P552 mogul base
Clear 1000 watt
120 volts
110 J11

May 9 1954
HSE

42 μ m
25 ft = 1 μ s.
950 \pm 50 shms.

Data from Ogle.

935 photo tube 600V 50,000.

Sunlight (direct) 60 volts.

$$I = \frac{60}{50,000} = 1. \text{ ma.}$$

Sens. 8.70
30 μ a/lumen. 2650° light.

$$\text{lumens} = \frac{1000 \mu\text{a}}{30 \mu\text{a/lumen}} \times 30 = 30 \text{ lumens.}$$

cathode area $1.5/16 \times 5/8 \text{''} \approx .6 \text{ sq inch}$

$$\frac{30}{.6} = 50 \text{ lumens/sq inch} = 7000. \text{ lumens/sq ft}$$

Bomb Y.

2w
2000
100 ma. search factor
600. 2 ma at 4000 ft sta.
.0057 ma. at 10,000 yds.
1 sun = 1 ma
Light at 10,000 yds $\approx \frac{1}{200}$ sun \pm .
at 15,000 yds $\approx \frac{1}{400}$ sun.
abs. factor 10 = $\frac{1}{4000}$ sun.

daylight $\cdot 7000^\circ \text{K.} \times 2$

$$2 \times 7000 = 14,000$$

lumens/sq ft

10,000 yards valley = 1 sun

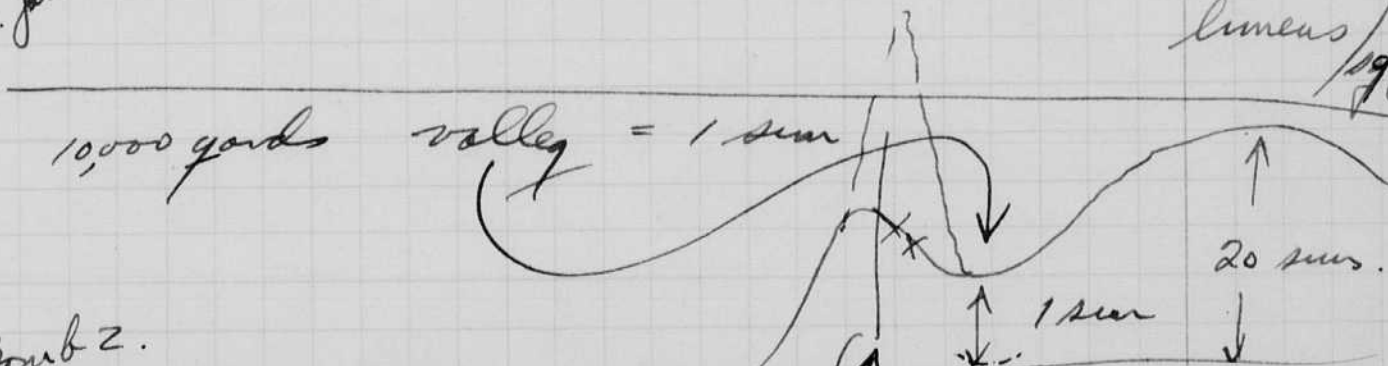

Back to Bomb Z.

8.9 miles = 15,700 yds.
8.9 miles = 47,000 ft
Filter density 1.
factor of 10 in light.

This brilliance may be as much as 1000 suns. Sonne photos shows 2 mile diam of first ~~Bomb~~ Pulse.

The fire ball has a diam of 2400.

84

May 9, 1948.

Herold S. Edgerton

Color Photos
of Sea Shells.

CM 28.

Dr. Dräger.

Jerry. Brancato.

Parry control station

Photo multiplier #50 in 36" searchlight.
Lumit tower bare lamps no reflectors.

Night light = 22 ua. (wide open)

ua.	Lamps	Voltage	shutter
230	3	149	$4\frac{11}{16}$ "
115	1	158	"
215	1	156	open.

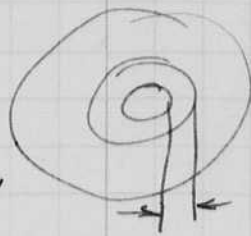
15ua
night.

20ua night.

On the following day the multiplier voltage was changed from 1560 to 1360 volts.

Static reading low light changed from 110 to 42 ua..

May 10 1948
calcSens. ratio Lumit.

$$\frac{215}{115} \times \frac{230}{.16} = 2690$$

$$\text{after change} = 2690 \frac{42}{110} = 1030$$

Comon experiment Point Y.

$$\frac{\text{Parry 931}}{\text{Comon 935}} = 1000 \text{ to } 1200.$$

Unit Setup as of May 9, 1948.

3900' station from
Bomb Z.

Photos of Searchlights
and Naphthalene exp.
PL 341 1- photos
Sgt Deutch.

Searchlights.

Scope III.

Trigger 935 Phototube^{tube} - 27' to scope.

Signal 935 Phototube - 100' to scope 93' delay.

Doghouse setup.

Trigger 931 Photo multiplier tube naphthalene. 31'
#7 see page 56 for calib.

Scope 113.

Signal 931 Photo multiplier tube naphthalene 142'
#33 see page 58.

20 removed
May 11

122'

Scope 122.

Signal 935 Phototube naphthalene.

90'

Perry Changes for Bomb Z.

a 935 has been substituted into one of the
signal search lights in place of ~~the~~ one of
the 931 tubes. Twenty feet have been taken
off the signal cable since ~~signal~~ the signal
will be delayed some due to the lower sensitivity
of the 935 phototube. These changes were made by
Colson and Eberhard about May 7.

Unit calibration of 931 photo mult.
with naphthalene

Trigges #7 PM 931 with naphthalene.

1 curie source 6" distance from
PM Surface gives 55 ua
+ 1 dark.
Δ 54 ua.

Signal #33 931 with naphthalene.

1 curie source 6" distance from
PM Surface gives 35 ua
- 1 dark.
26. ua

Cable lengths.

May 11, 1948. Changes in sweep circuit of scope 122

The 700 uu sweep capacitor was changed to 1300 uu.
Osc. 684 shows speed sweep before change Ring.
685 " " " after " Ring.
683 " " " before change 200 mc
687, 686 show argon flash with slow speed sweeps.

The second reflection is noticeable at the end of the sweep with 90 ft of 62 v line. I estimate that 20 additional feet will cause the reflection to come after the sweep is over. The intensity pulse circuit was not changed. Therefore the duration is about 0.3 us.

Light Sensitivity calculation for Eugebi Bomb X.

Distance from tower to Searchlight = 3900 ft.

Sens. of Photomultiplier (Rated value) $\frac{20}{70}$ amp/lumen?
(estimated)

The tube manual gives a value of 10 amp/lumen with 1250 volts max across the 9 stages.

$1250/9 = 139$ volts per stage.

We used about 150 volts per stage for the Eugebi test. From Fig 2 J. O.S. A Vol 37 no 6 June 1947 p 420 Ralph W. Engstrom estimate that an increase from 135 to 150 volts per stage increases the sensitivity by a factor of $\#1.2$ (could be as low as 2).

Area of cathode $\frac{15}{16} \times \frac{5}{16} = .25$ sq inches

Without searchlight,

25 ma output corresponds to about half of saturation value. This is half of the peak deflection.

$\frac{.025 \text{ amp}}{20 \text{ amp/lumen}} = .00125$ lumens at cell

$\frac{.00125 \text{ lumens}}{.25 \text{ sq inches}} \times 144 = 0.720$ lumens/sq ft.

Estimated Searchlight factor = 600.

$\frac{0.720}{600} = 0.0012$ lumens/sq ft. at tower station.

Required output in candle power at tower =

$0.0012 \times 3900^2 =$

$15.2 \times 10^6 = .0183 \times 10^6$

$= 18,300$ h.c.p.

Total lumens output = HCP x 10

$= 180,300$ lumens

0.2×10^6 lumens

Distances

from Simmons May 11 1948.

Tower to Timer Stations on
Eugebi Aomon & Runit = 3900'

20.2 miles	Eugebi - Parry Control	=	20.2 miles feet. 106,646 yards.
16.2 "	Aomon - " "		16.1 miles 85,411 "
10.3 "	Runit " "		10.3 54,362 "

Change in Sensitivity from Eugebi Searchlight
to Parry Searchlight according to Square
law.

$$\left(\frac{3900}{\cancel{\times} 106,646} \right)^2 = \text{reduction factor.}$$

$$\left(\frac{\cancel{\times} 106,646}{3900} \right)^2 = \text{increase of lumens required at Eugebi Tower for half scale.}$$

$$\frac{736}{\underline{\underline{6630}}}$$

Light is attenuated about $\frac{1}{8}$ each mile
therefore this factor should be increased
by $\frac{106,646}{\left(\frac{5280}{\cancel{\mu}} \right)}$ miles = 20.2 miles.

$$8^{20.2} = \frac{1}{88} = .014$$

$$8^{16.1} = \frac{1}{30.7} = .0332$$

$$8^{10.3} = \frac{1}{9.9} = 0.101$$

$$0.8^{20.2} = \underline{\underline{.014}}$$

thus the ratio of light reqd = 736×100
 $\frac{\text{Parry record}}{\text{Eugebi record.}} = 73,600$

Eugebi

Light reqd for Eugebi = 0.2×10^6 lumens.
 " " for Parry = $14,700 \times 10^6$ lumens.

Light Sens. Calc. for 935 in search light.

Assume 935 sens = 40 μ a/lumen
ECA data sheets show 8 to 70 μ a/lumen.
Cathode area = 0.6 sq inches approx.

$$\text{Ratio of } 935/931 = \frac{40 \times 10^{-6} \text{ amp/lumen}}{20 \text{ amp/lumen}} = 2 \times 10^{-6}$$

Light required on tower for 931 (p87).

$$= .2 \times 10^6 \text{ lumens}$$

Light required on tower for 935

$$= .2 \times 10^6 \times \frac{1}{2 \times 10^{-6}}$$

$$= 0.1 \times 10^{12} \text{ lumens.}$$

Parry - Comon distance = 16.2 miles.

$$0.8^{16.2} = .027 \quad \times$$

$$\ln .8 = -0.223$$
$$\frac{-0.223}{16.2} = \frac{-3.61}{16.2} \quad \times$$

$$\ln^{-1} -3.61 = .027. \quad \times$$

Lunit Bomb Ybra May 1948.

Cable resistances 62

From Fed. Tel. Data Book.

54.8 ohms " 1000
49 ohms per 1000 ft.

935 Searchlights Trigger	1.4 ohms	23.8'
Signal	5.3 "	74.2'

17 feet = 1 ohm

20.8 = 1 ohm

18.2 = 1 ohm

931 Naphthalene Trigger	1.5 ohms.	21'
931 Signal	7 ohms	98'
935 Signal	6 ohms	84'

Perry Searchlights. West	3.4 ohms	47.6'
East	5.0 ohms.	70.0'

measured by Simpson

			935.	Perry.
Kranse	Y	2.4	—	931
	Y	.86	1.1	1.0
	2	0.90	1.5	1.
			X	

Changed later, see page 94.

Gamma Ray Intensity. Calc.

N.G.
see page 98

King says
2.3 gammas per
disintegration
from source.
 7×10^6 kWh
= 20,000 ton bomb.

at the max. activity the rate of gamma ray output is
about 10^{27} gamma rays/sec. (Possibly 10^{28} at peak.)
Assume 10^{25} .

Gamma Ray flux at 3900 yards.

$$\epsilon^{-4.34} = \frac{1}{77} = .013$$

$$G = \frac{10^{25}}{4\pi 3900^2} \epsilon^{-\frac{3900}{900}} = .52 \times 10^{19} \cdot .013 = .0068 \times 10^{20}$$

Assume $\lambda = 300$ yds.

g/sec/sq ft.
at timer station.

Experiment with Radium (Curie) at Runit.

Assume 3.7×10^{10} disintegrations gamma/sec. X

$$\text{Flux at 6"} = \frac{3.7 \times 10^{10}}{4\pi .5^2} = 1.18 \times 10^{10} \text{ gammas/sec/sq ft.}$$

This flux produces about 25 microamperes
in our 931 photo multiplier setup with
Naphthalene.

With the 935 the current should be 10^{-6} less.

$$S = \text{Sens of 935} = \frac{25 \times 10^{-6} \text{ ua}}{1.18 \times 10^{10} \text{ g/sec/sq ft.}} = 21.2 \times 10^{-16} \text{ ua/g/sec/sq ft.}$$

Current due to max activity of bomb.

$$V = IR = 21.2 \times 10^{-16} \times .0068 \times 10^{20} = 3.5 \text{ volts.}$$

This will scarcely be visible on the scope.

Gamma intensity for domon shot assuming 25 ua for half scale.

931. $1.18 \times 10^{10} \times 10^3$ gamma/sec/sq ft. required
 $G = 1.18 \times 10^{13}$ at timer station.

For Engelbi shot. 935 $1.18 \times 10^{13} \times 10^6 = 1.18 \times 10^{19}$ gammas/sec/sq ft.

From 738 Runit 25 volts deflection at end of record. - means 25V at C.F. grid
 $\frac{25}{2400} = 10 \text{ ma}$ $\frac{10,000}{20 \times 10^{16}} = 5 \times 10^{18}$ gammas/sec/sq ft.

May 15 1948
David Edgerton.

Bomb Zebra "Z" went off on schedule at 6.06 am - this morning. It was a very clear morning with a few distant clouds in the east to reduce the early morning light.

I was at the trigger 931 photo multiplier station on the top of the control tower at Perry Island. The diaphragm of my searchlight was open 10" from the center disk. According to data on page 57, this gives $\frac{270}{300} = 90\%$ of full sensitivity. The photo multiplier current was 150 μ a.

Shepard was at the other station on the ~~west~~ tower to the south. The 935 iris was wide open while the 931 iris was at $\frac{1}{2}$, giving 50% operation.

The bomb image on the 935 cathode was plainly visible after the shot.

Also the 931 trigger tube had some wires melted in front of the cathode, the other PM cell showed a cathode that had been heated, but there was no melting. These tubes were marked and removed for possible further study in Boston.

We took the 7:15 boat to the Albemarle where Charlie Wyckoff developed the negatives.

West Searchlight type 319 Dumont Scope # 105
tube type 148 1223 S.
935 Phototube.

East Searchlight type 319 Dumont Scope # 106
tube type 148 1192 S.
931 Photo multiplier.

The record on the 931 showed the normal form. The amplitude of the 935 signal was small on the West searchlight. This sweep should have been increased.

Brixner f32 & Dens filter ($\frac{1}{100}$) $\frac{1}{5000}$ sec shutter 100-125 pist/sec.
Mitchell camera.

Run
at 0 time
Phase 1 117
2 115
3 116.

Perry 200 mc. Oscillator Calib.
 G.R. Type 620 Heterodyne freq meter.
 200 mc \rightarrow 206.8 mc. on scale.

photographer.
 EC, UDEY
 Tanka Base
 Albuquerque
 N.M.

202.4 mc read on dial.

$$\text{Real freq} = 202.4 \times \frac{200}{206.8} =$$

TRANSIT TIME. FROM 931 NAPHTHALENE at Unit 8.

May 15 1948

~~Lab~~ Bomb Zebra Z

Krause Record 2025.

Data from Dr. Strain and C.H. Smith. $115.45 \pm .25$
 us.

(This checks $115.46 \pm .25$ from Krause in chamber ~~data~~)

$$T = T_{\text{Spiral Sweep}} + T_{\text{432}}^{6.34 \mu\text{s}} - T_{\text{air}} - T_{\text{31}}^{62.0} - 0.1 \text{ Scope}$$

$$- T_{\text{80}}^{8m} - 0.12 + .02 (\pm .02) \text{ Spiral Sweep.}$$

Air Path = $3.97 \mu\text{s}$ for 3906'
 Cable from X unit 6.34 us.

The spiral sweep ~~signal~~ ^{intensity} was turned off about 2 us after the record was made by the signal from the X unit? This same phenomena happened on shot X-ray.

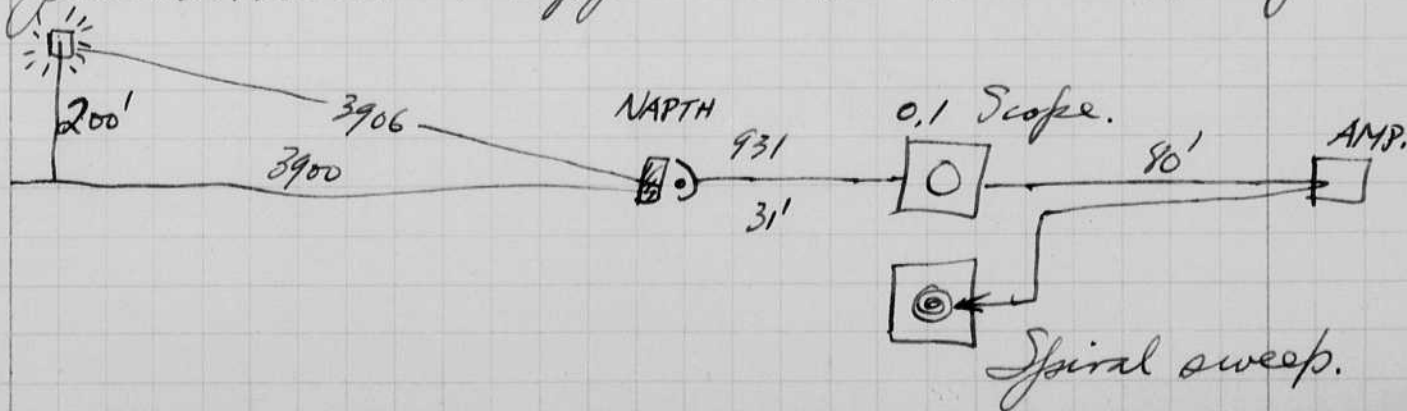

Krause ~~2~~ values of May 16, 1948.
after replot of data. $\times 10^2$

	Krause	Searchlight 3900'	Searchlight PERRY	Nafta 3900'	Search Party	NAF
		935	106 931 105 EAST WEST	931	935	935
X	2.17					
Y	0.815	1.12	.955 .8	1.05		
Z	0.75	1.1	.96	.99	—	0.1

$\times 106.$ $\times 105$

May 20 1948
 H. S. Edgerton
 Eniwetok.

Comments on Runit Zebra explosion. of May 15 1948.

The G.C. 36" searchlights on the roof at Runit were not tipped over or blown away by the blast. At Engebi (x) they were tipped over and slid back to the edge of the shelter. At Lomon they were both blown over and one was even blown off the shelter. This indicates that the Runit explosion was not as violent as the others. The glass was broken in all searchlights for all shots.

The wooden house covering the naphthalene experiment was not destroyed or damaged. Ed Colson is going to keep the dimensions of this house. The roof was slanted towards the explosion.

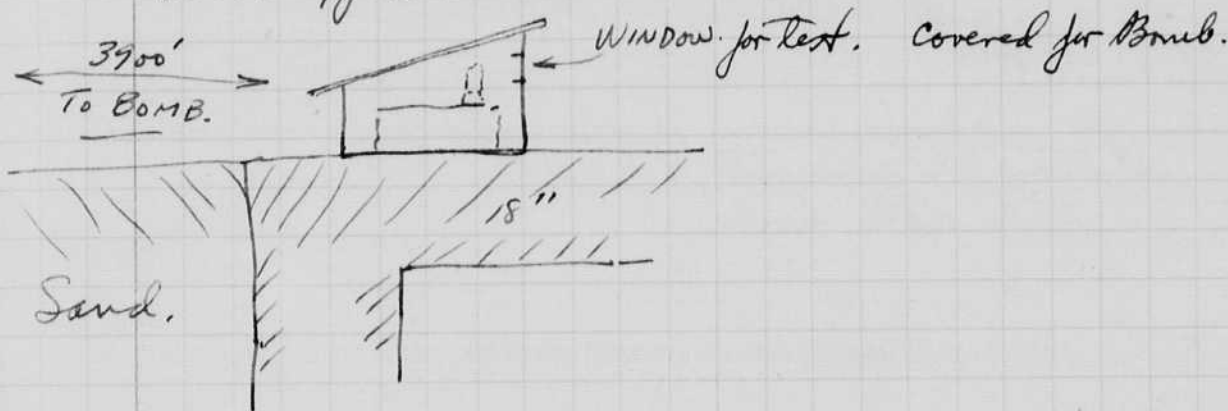

The albemarle took about 150,000 gal of fuel oil two days ago. At this moment the entire task force is at anchor at Eniwetok awaiting word to start for Hawaii.

Sensitivity calc of Data of p82.84.

Photocell 935 at ~~Conrad~~ ^{Runit} 6 Lamps ^{1000 watt} 150 volts, 28 ma 3900'

Photo mult. 931 at Parry. 1 " 158 215 54.362'

$$\frac{931_{\text{sen}}}{935_{\text{sen}}} = \frac{215 \left(\frac{54,362}{3900} \right)^2 \times 10 \times 6}{0.28}$$

neglecting
different
voltages.

$$= 0.9 \times 10^7$$

should be about 1.0×10^6
RCA data books.

GE letter says 51,600 lumens at 150 v, color temp 3340° K
extrapolate 62,500 " " 158 v " " 3410° K

$$\frac{516}{625} \times 9 \times 10^7 = .75 \times 10^7$$

Notebook # 18

Filming and Separation Record

___ unmounted photograph(s)

___ negative strip(s)

1 unmounted page(s)
(notes, drawings, letters, etc.)

was/were filmed where originally located between page 96 and 97.

Item(s) now housed in accompanying folder.

Sensitivity calc of Data of p82.84.

Photocell 935 at ~~Conna~~ ^{Runit} 6 ^{1000 watt} lamps 150 volts, 28 ma 3900'

Photo mult. 931 at Parry. 1 " 158 215 54.362'

$$\frac{931 \text{ sen}}{935 \text{ sen}} = \frac{215 \left(\frac{54,362}{3900} \right)^2 \times 10 \times 6}{0.28}$$

neglecting
different
voltages.

$$= 0.9 \times 10^7$$

should be about 1.0×10^6
RCA data books.

G.E. litter says 51,600 lumens at 150 v, color temp 3340° K
extrapolate 62,500 " " 158 v " " 3410° K

$$\frac{51.6}{62.5} \times 0.9 \times 10^7 = .75 \times 10^7$$

Notebook # 18

Filming and Separation Record

___ unmounted photograph(s)

___ negative strip(s)

1 unmounted page(s)
(notes, drawings, letters, etc.)

was/were filmed where originally located between page 96 and 97.

Item(s) now housed in accompanying folder.

LAMP DEPARTMENT
GENERAL ELECTRIC
COMPANY

ENGINEERING DIVISION
PHOTOGRAPHIC AND PROJECTION
F. E. CARLSON
R. E. FARNHAM

NELA PARK
CLEVELAND 12, OHIO

June 2, 1948

Dr. Harold E. Edgerton
Edgerton, Germeshausen & Grier,
77 Massachusetts Avenue,
Cambridge 39, Mass.

Dear Dr. Edgerton:

I am sending you the data you asked Frank for in your letter of May 15th. Assuming the lamp to which you refer is the 1000-watt PS52, 120 volt, 1000-hour life clear bulb lamp, the following calculated data will hold rather closely:-

<u>Volts</u>	<u>Lumens</u>	<u>Approx. Color Temp.</u>
100	13,100	2865° K
115	21,000	3020
120	24,400	3080
143	44,000	3280
150	51,600	3340

These data were calculated by using known coefficients applied to a single set of measured values. I hope these will be sufficiently accurate for your purposes.

Very truly yours,

RICHARD BLOUNT

RB:RD

LAMP DEPARTMENT
GENERAL ELECTRIC
 COMPANY

RECOMMENDATION
 BY THE ENGINEER
 IN CHARGE
 OF THE DEPARTMENT

Jan 2, 1913

Mr. [Name],
 [Address],
 [City],
 [State]

Dear Sir:

I am writing you the data for the [type of lamp] lamp
 which is the [type of lamp] lamp. The lamp is
 in the [type of lamp] lamp. The lamp is
 the [type of lamp] lamp. The lamp is

Item	Quantity	Unit Price	Total
[Item 1]	[Quantity 1]	[Unit Price 1]	[Total 1]
[Item 2]	[Quantity 2]	[Unit Price 2]	[Total 2]
[Item 3]	[Quantity 3]	[Unit Price 3]	[Total 3]
[Item 4]	[Quantity 4]	[Unit Price 4]	[Total 4]
[Item 5]	[Quantity 5]	[Unit Price 5]	[Total 5]
[Item 6]	[Quantity 6]	[Unit Price 6]	[Total 6]
[Item 7]	[Quantity 7]	[Unit Price 7]	[Total 7]
[Item 8]	[Quantity 8]	[Unit Price 8]	[Total 8]
[Item 9]	[Quantity 9]	[Unit Price 9]	[Total 9]
[Item 10]	[Quantity 10]	[Unit Price 10]	[Total 10]
[Item 11]	[Quantity 11]	[Unit Price 11]	[Total 11]
[Item 12]	[Quantity 12]	[Unit Price 12]	[Total 12]
[Item 13]	[Quantity 13]	[Unit Price 13]	[Total 13]
[Item 14]	[Quantity 14]	[Unit Price 14]	[Total 14]
[Item 15]	[Quantity 15]	[Unit Price 15]	[Total 15]
[Item 16]	[Quantity 16]	[Unit Price 16]	[Total 16]
[Item 17]	[Quantity 17]	[Unit Price 17]	[Total 17]
[Item 18]	[Quantity 18]	[Unit Price 18]	[Total 18]
[Item 19]	[Quantity 19]	[Unit Price 19]	[Total 19]
[Item 20]	[Quantity 20]	[Unit Price 20]	[Total 20]
[Item 21]	[Quantity 21]	[Unit Price 21]	[Total 21]
[Item 22]	[Quantity 22]	[Unit Price 22]	[Total 22]
[Item 23]	[Quantity 23]	[Unit Price 23]	[Total 23]
[Item 24]	[Quantity 24]	[Unit Price 24]	[Total 24]
[Item 25]	[Quantity 25]	[Unit Price 25]	[Total 25]
[Item 26]	[Quantity 26]	[Unit Price 26]	[Total 26]
[Item 27]	[Quantity 27]	[Unit Price 27]	[Total 27]
[Item 28]	[Quantity 28]	[Unit Price 28]	[Total 28]
[Item 29]	[Quantity 29]	[Unit Price 29]	[Total 29]
[Item 30]	[Quantity 30]	[Unit Price 30]	[Total 30]
[Item 31]	[Quantity 31]	[Unit Price 31]	[Total 31]
[Item 32]	[Quantity 32]	[Unit Price 32]	[Total 32]
[Item 33]	[Quantity 33]	[Unit Price 33]	[Total 33]
[Item 34]	[Quantity 34]	[Unit Price 34]	[Total 34]
[Item 35]	[Quantity 35]	[Unit Price 35]	[Total 35]
[Item 36]	[Quantity 36]	[Unit Price 36]	[Total 36]
[Item 37]	[Quantity 37]	[Unit Price 37]	[Total 37]
[Item 38]	[Quantity 38]	[Unit Price 38]	[Total 38]
[Item 39]	[Quantity 39]	[Unit Price 39]	[Total 39]
[Item 40]	[Quantity 40]	[Unit Price 40]	[Total 40]
[Item 41]	[Quantity 41]	[Unit Price 41]	[Total 41]
[Item 42]	[Quantity 42]	[Unit Price 42]	[Total 42]
[Item 43]	[Quantity 43]	[Unit Price 43]	[Total 43]
[Item 44]	[Quantity 44]	[Unit Price 44]	[Total 44]
[Item 45]	[Quantity 45]	[Unit Price 45]	[Total 45]
[Item 46]	[Quantity 46]	[Unit Price 46]	[Total 46]
[Item 47]	[Quantity 47]	[Unit Price 47]	[Total 47]
[Item 48]	[Quantity 48]	[Unit Price 48]	[Total 48]
[Item 49]	[Quantity 49]	[Unit Price 49]	[Total 49]
[Item 50]	[Quantity 50]	[Unit Price 50]	[Total 50]

These data were calculated by using the [type of lamp] lamp
 which is the [type of lamp] lamp. The lamp is
 in the [type of lamp] lamp. The lamp is
 the [type of lamp] lamp. The lamp is

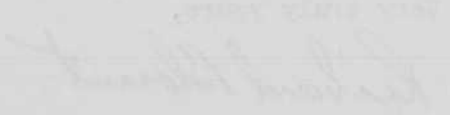
Very truly yours,

 [Name]
 [Title]

1913

Washington, May 18--(UP)--The U.S. geared up today for production of new atomic weapons whose deadly power is this nation's secret.

This much is known--that whatever their form or dimensions they represent "very substantial progress" in harnessing nature's forces to instruments of terrible destruction.

Those were the words used by the White House yesterday in announcing successful completion of a new series of tests of "three atomic weapons, each of improved design" at Eniwetok island in the far Pacific.

Speculation mounted over what the new weapons may be. "Whatever they are--guided missiles, radioactive clouds, an improved bomb or whatnot--the white house announcement indicated no time is being lost in putting them into production. It said:

"The President gave general approval of AEC plans for steps it proposed to initiate at once for further nuclear development, based upon information gained from the tests.

David E. Lilienthal, AEC chairman, added pointed emphasis to this statement. He said the tests, involving some 10,000 military and scientific personnel, were a "milestone in atomic development."

"With the nation thus embarked on a new atomic era, there were indications the armed forces are grooving their plans for using the new weapons.

The air force has new sky giants in the making to replace the famed B-29 which dropped the first atomic bomb on Hiroshima three years ago. And the Navy has asked Congressional approval of plans to construct the world's biggest aircraft carrier.

Honolulu, May 18--(UP)--The recent atomic test at Eniwetok atoll consisted of three nuclear explosions that were "completely successful," Lt. Gen. John E. Hull, commander of Joint Task Force Seven, said today.

Hull and other commanders of Operation Sandstone made public further hints as to the form of the latest United States atomic weapons when they said flatly that the tests were centered around explosions.

"It can be said that the bombs worked," Hull said.

Three nuclear explosions were involved, he and the other commanders said in a joint statement. But, they added, none of the explosions were underwater or aerial.

They refused to say how the improved weapons were detonated or whether any weapons besides the bombs were involved.

Hull and his aides returned by plane this morning from the Pacific island and held a press conference a few hours later.

He said the project was being rolled up and the ships of the task force were leaving the Marshalls shortly. "A garrison will be kept there for future tests "when they become necessary," he said.

Doctor Carol Froman, scientific director of the tests, said they "involved a series of nuclear explosions carried out under conditions as close to laboratory control as we could make them and with very extensive instrumentation."

The ultimate purpose of the tests, Froman said, "is to insure the efficient utilization of national resources required for the development and application of atomic energy."

Gamma Ray Calc from 935 naphth.

May 20 1948.

Zebra Unit Scope 122 FILM 738 Sig.

The deflection on the film showed an increasing signal at 0.375 micro seconds from the start of the 931 record. See data sheets in envelope on Sig. 738 (film no.).

The current from the photocell is 8.4 ma at the end of the record.

Approx. calibration of photocell in terms of radium source. (See other attempt on page 91).

Experiment 1 curie source of radium at 6" distance gives 25×10^{-12} amps with a 931 PM tube with naphthalene.

Assume 935 - 931 ratio = 10^{-6}

then 1 curie source 6" from 935 should give 25×10^{-12} amp.

Gamma rays from 1 curie source = 2.3 x disintegrating per sec.
 $= 2.3 \times 3.7 \times 10^{10}$ gammas/sec.
 $= 8.5 \times 10^{10}$ gammas/sec.

$$S = \text{Sensitivity} = \frac{i/G}{\text{gammas/sec./sq. cm}} = \frac{25 \times 10^{-12}}{\frac{8.5 \times 10^{10}}{2.3} / 4\pi (6 \times 2.54)^2} = \frac{19.8 \times 10^{-19}}{19.8 \times 10^{-19}} = 1 \text{ amp/2/sec.}$$

$$G = \frac{i}{S} = \frac{.0084}{.858 \times 10^{-19}} = 0.98 \times 10^{16} \text{ gammas/sec./sq. cm.}$$

Gamma rays from Bomb. no absorption.

$$4\pi R^2 G = 4\pi (3900 \times 12 \times 2.54)^2 \frac{.475}{1.19 \times 10^{10}} \times 10^{16} = 6.37 \times 10^{26} = 1.47 \times 10^{26}$$

assume m.f.p. = 300 ft. then absorption factor is

$$\Sigma^{-3900/300} = .013 \text{ and gammas from bomb are increased by } 77. = 1/.013$$

$$\text{Bomb Gammas/sec./sq.} = \frac{1.47 \times 77 \times 10^{26}}{6.37} = .49 \times 10^{29} = 1.13 \times 10^{28} \text{ and still going}$$

May 24 1948. Half way from Eirivetok to Honolulu.

H. Edgerton.

Some effort has been expended on the results of our work at Eirivetok.

A correction factor curve is plotted below which corrects for non linearity of the cathode follower and saturation effects in the photo sensitive devices. The tube curvature correction (4X150) was measured statically by Colson, and also the overall gain was measured by light flashes with square law.

931. Correction curve.

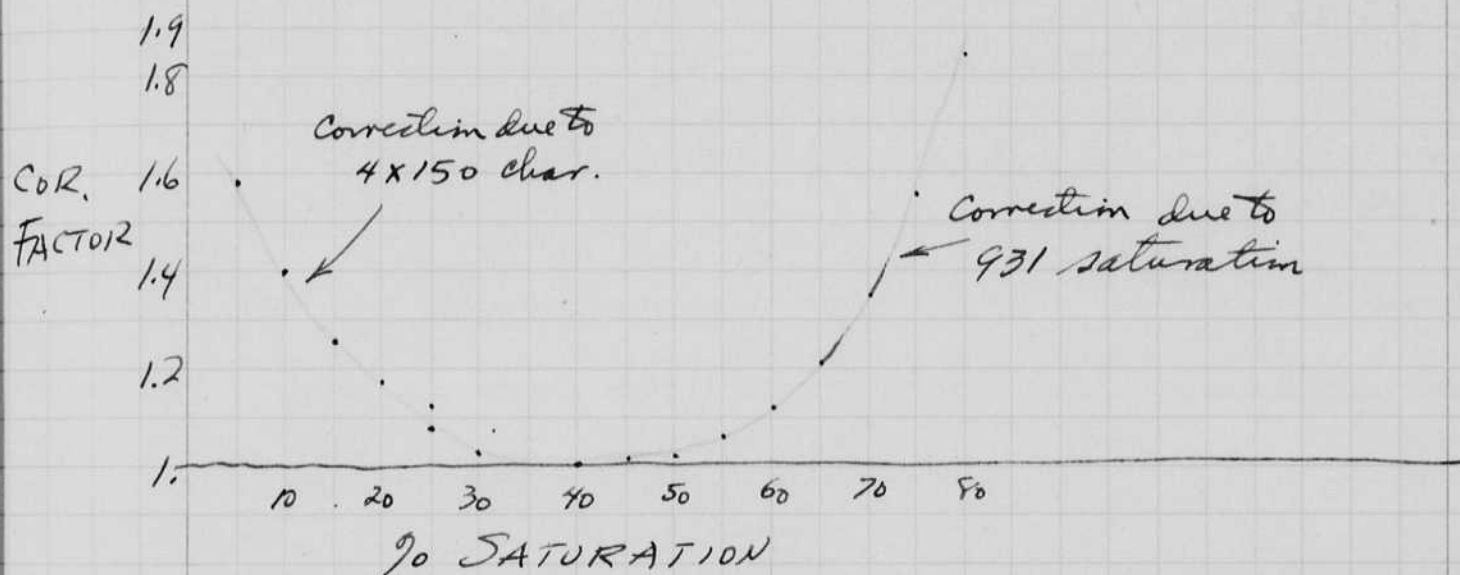

For 935 curves - the portion from 0 to 40% was used.

All log plots for curves of X, Y, and Z tests have been corrected from the above and new values of α calculated. A summary of the data appears on the following page. Compare this corrected data to data on page 94. In general, the correction of the 0-40% values tend to reduce the value of α by about 10%.

57
 8/2/44
 AT Shafter
 Gen. Hull.

	SEARCHLIGHT 935 3900 FT	NAPHTHALENE 931 3900 FT	PARRY SEARCHLIGHT 931		KRAUSE (ESTIMATES)
X	-	-	1.07 *	1.01 *	2.17
Y	0.91	0.82 .77	.84 **	.66 **	0.815
Z	0.87	0.77 .64	.73 ***	-	0.75

* 20.2 MILES FROM BOMB.

** 16.1 " " "

*** 10.3 " " "

all values to be multiplied by 10^8

Calculation of Flux reqd for $\frac{5}{8}$ " deflection on scope (1" on prints) 101

Engelbi 931 Searchlight. Load resistor = 1000 ohms.

Gain of cathode follower at $\frac{5}{8}$ " def = 0.5

Gain of trans mission line = 2.0

Total gain = 1.0

Sens of C.R. tube = 200 volts/inch.

Thus the $\frac{5}{8}$ " deflection = $200 \times \frac{5}{8} = 125$ volts.

This corresponds to $\frac{125}{1000} = 0.125$ amperes.

Sensitivity of 931 = 40 amp/lumen.

Lumens = $\frac{.125}{40} = .0312$ lumens. = .003 lumens.

* \rightarrow Lumens/sq ft = $\frac{.00312}{.25 \times 144} = .000866 = .0000866 = 8.66 \times 10^{-5}$

$F =$ Search-light lumens/sq ft. = $\frac{.00312}{.25 \times 144 \times 600}$

$\cdot 8 \frac{3.9}{5.28} = .74$
 $= .85$ = transmission

$F = 1.44 \times 10^{-7}$ lumens/sq ft.
 incident at searchlight.

Total flux = $\frac{4\pi d^2 F}{\text{Transmission}}$

= $\frac{4\pi 3900^2 1.44 \times 10^{-7}}{.74} = 32.4$
 $= 37.2$ lumens.

Perry. Flux = $\frac{4\pi (806,646)^2 1.44 \times 10^{-7}}{.014} = 1.47 \times 10^6$ lumens.

$\frac{1.47 \times 10^6}{37.2} = 3.6 \times 10^4 = 36,000 =$ Ratio of sens Engelbi/Perry.

Aoman 583 Flux = $\frac{4\pi 3900^2 1.44 \times 10^{-7}}{.074} = 37.4$
 $= 37.2 \times 10^6$ lumens.

Perry 579 Flux = $\frac{4\pi (85,411)^2 1.44 \times 10^{-7}}{.0332} = 3970$ lumens.

* The 144 factor should be in the numerator.

LIGHT
 TRANSMISSION
 P 88

⁴⁰
 Light Flux for deflection.

 See sample calc
 on page 101.

TEST.	DISTANCE FT.		PICKUP.	LIGHT FLUX FOR 5/8" DEF. LUMENS/SQ.FT.	BOMB FLUX LUMENS	α $\times 10^8$	
X 500	3900	.85	SL 931	1.44×10^{-8}	^{33.2} 372	—	too sensitive.
X 400	106,646	.014	SL 931	1.44×10^{-7}	1.47×10^6	1.07	
X 402	106,646	.014	SL 931	1.44×10^{-7}	1.47×10^6	1.01	
Y 583	3900	.85	SL 935	0.144	^{32.4} 37.2×10^6	.91	
Y 579	85411	.0332	SL 931	1.44×10^{-7}	397,000	.84	
Y 578	85411	.0332	SL 931	1.44×10^{-7}	397,000	.66	Faulty 931?
Z 745	54362	.101	SL 9				
Z 745	3900	.85	SL 935	0.144	^{33.4} 37.2×10^6	.875	
Z 753	54362	.101	SL 931	1.44×10^{-7}	⁹ 52,700	.73	
Z 751	54362	.101	SL 935	0.144	$52,700 \times 10^6$	—	

The above estimates are calculated using the following assumptions.

Sens. of 931 Photo multiplier is 40 amp/lumen.
 Surface area of 931 PM is 0.25 square inches.

Sens. of 935 Phototube is 40 microamperes/lumen.
 Surface area of 935 cathode is 0.6 sq inches.

Searchlight factor = 600.

Light transmission = 0.8 per mile (OBrian data).

Eugeli - Parry	20.2 miles	$.8^{20.2} = .014$	transmission
Canon - Parry	16.1 "	$.8^{16.1} = .0332$	"
Runit - Parry	10.3 "	$.8^{10.3} = .101$	"

F12M

X	Parry	106	East.	400
X	"	105	West	402

Y	Parry	106	East	579
Y	"	105	West	578
Y	Adman		931 nap	582
Y	Adman	121	935 Search	583

Z.	Parry	106	East	753
	Parry	105		
	Runit	111	Search	745
	"	113	931 nap	740

Los Alamos Cruise, July 1948 B-225 830

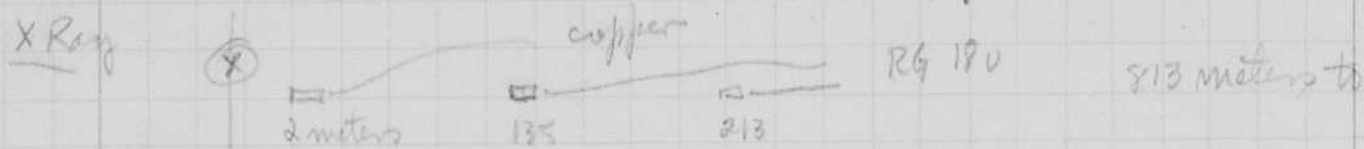

estimate 10^{10} fission Rossi 2-40 pounds for Rossi meas.

Y -

Z -

Lead house not necessary at 1300 yds with $\chi/2$ bombs.
Dirt necessary around concrete bomb proof.

α constant as measured to about 475 meters from bomb with iron clean

X.	2.15	2.08	2.07	475 meters	
Y.	.78	.76	.74	.76 → .74	
Z	.77	.81		.8-.75	.51 - .12

3×10^{-5} gammas per fission } Considerable
might be 10^{-2} " " " } argument by
teller and others

Edg →

C. Strain afternoon Transit time.

			#1	#2	931
115.4	X Ray	Uncorrected	115.20	115.35	931.
		Corrected	115.0	115.15 (?)	
116.7	Yoke	Uncorrected	116.37	116.73	935.
		Corrected	115.87	115.73 (?)	
115.4	Felra	unc	115.43	115.54	931 map
		Corrected	114.83	114.84	

Richardson

ast

Taschek.
 Friday A.M.
 Los Alamos.

Discussion

Lower
 limits
 Tons.

	Rossi	Teller			NAP 931
X	2.1×10^8	$.9 \times 10^8$	20 mile	$\frac{1}{4}$	—
Y	$.76 \times 10^8$	$.9 \times 10^8$ $.63 \times 10^8$	935 931	17.6m — 5.4 — .067	.82 — 0.77
Z	$.79 \times 10^8$.87 } .76 }	935	5.4	
		.64	931	18#	0.77 0.64

5×10^{16} \downarrow 5 in 2T. $\leq .7$ lumen / meter²

Experiment at
 Los Alamos.
 Conversion of
 gammas to light.

Trinity 2500 ton level α drops to about $\frac{1}{2}$.
 500 tons α " $\frac{1}{90}$.

Los Alamos

Brixner.

.0001 sec resolution 10 fastax cameras.
 1-30,000 reduction on film.
 accurate to 1 to 3 meters.

Shock wave growth.

motion of water should show shock wave at late stage.

Fred. Reines analysed films.

Two positions at 90°
 10,000 frames/sec.

75 ft towers for cameras

It appears to occur where the cables leave the bomb.

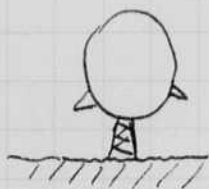

Energy of bomb important since

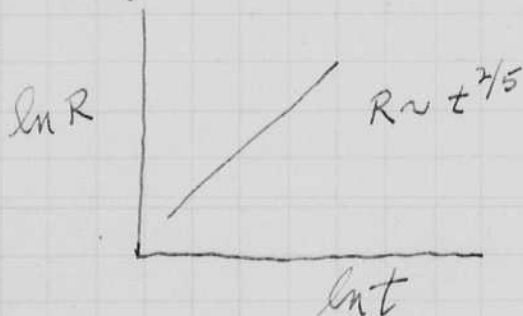

Bethie.

Fuchs

Trinity shows $T^{2/5}$

O'Brien -

10 m.s. record of Bikini

25 Tons ± 2.5

21.5

x, y, z, also show $T^{2/5}$

#4 B was compared to Trinity.

Ground is hit in $1/2$ m.s.

Los Alamos

Reines

107

Breakaway radius $E = 2.43 \times 10^{-6} D_B$

where sound wave
leaves the fire ball.

Trinity 100 meter radius.

Radiation is not taken into account in the $R = t^{2/5}$ law.

Reines says radiation is so small as to be not important.

Possible bounce of fire ball at instant of ground?

Microdensity of film across the ball of fire

is radius of sphere as function of diam.

Transmission as a function of time during bomb.

Greater speed of camera. Initial event.



10⁻⁷

Los Alamos

Gamma Ray level for trip.

Discussion with Strain
for NRL report on transit time.

See page 98.

Exp 1 curie 6" dist 25×10^6 amps
PM tube,

$$\begin{aligned} \text{Counts/sec} &= 2.3 \times 3.7 \times 10^{10} \\ &= \cancel{8.5} \times 10^{10} \quad 3.7 \times 10^{10} \end{aligned}$$

for 0.1 amp.

$$G = \frac{0.1}{8.58 \times 10^{-13}}$$

$$\frac{\text{amp.}}{\text{Gamma/sec/cm}} = 8.58 \times 10^{-13}$$

for 100 ma of current to deflect scope
and trip.

$$G = \frac{0.1}{8.58 \times 10^{-13}} = \text{Gamma/sec/cm}$$

July 12
X
Note.

The factor 2.3 is wrong according to
Ogle and Lindenberg.

This was discussed with Strain of NRL
just before leaving Los Alamos.

$$1 \text{ curie at 1 ft gives } \frac{25}{4} \times 10^6 \text{ amps} = 6 \text{ ma.}$$

$$\text{for } 100 \text{ amp } 1 \times \frac{100,000}{6} = 16,700 \text{ curies at 1 ft.}$$

$$.125 \text{ amp. } 1 \times \frac{125,000}{6} = 20,800 \text{ " at 1 ft.}$$

$$\begin{aligned} \text{Gamma ray flux density} \\ \frac{20,800 \times 3.7 \times 10^{10}}{4\pi} &= 6130 \times 10^{10} \\ &= 7/04 \text{ ft.} \\ (2.54 \times 12)^2 &= 925. \quad \text{or } \frac{6130 \times 10^{10}}{925} \\ &= 6.62 \times 10^{10} \end{aligned}$$

July 13 1948.

109

Chas Wyckoff and I left Washington D.C. on
Tues. Wednesday July 7 for Los Alamos N.M. to
present results of the Euiwetols tests of
the spring. Also with us were a group from
the N.R.T. of the Navy. under Krause.
Smith Strain Richardson Butler Sanderson
Card Durand

Most of us returned with the plane 854
D 47 from Albuquerque on Sunday July 11
arriving in Washington about 8-30 pm.
The night train brought us to Boston.

Sanderson suggested microcrystalline wax
on a sphere as a radiant energy
integrator. The stuff will melt at a
definite temperature.

Report to see

Julian Mark Trinity.
LA 588 July. Sept. 5, 1945?
Prelim report of the Spectrum and Radiation.
S.N. Nicholson
F.E. Geiger (Madison).

U. S. Secretly Tests Atom Weapon; Lilienthal Board to Be Renamed

By JAY WALZ

Special to THE NEW YORK TIMES.

WASHINGTON, April 19—"An atomic weapon" has been tested at the newly constructed proving grounds on Eniwetok Atoll in the Marshall Islands, the Atomic Energy Commission announced today.

The guarded and brief announcement did not reveal the type of "weapon" that was tested, and it said not even the date on which the test was made could be made public "for security reasons."

However, there were Congressional rumors last week that the sixth explosion of an atomic bomb, and the first to be announced since Bikini two years ago, had taken place on Eniwetok, one of the former islands held under Japanese mandate.

This led to speculation today

that the "weapon" may have been an improved bomb that was exploded under strictly controlled conditions to determine how much more effective today's bombs were than those dropped on Hiroshima and Nagasaki in 1945, and those tested in Bikini a year later.

There was also some belief that the test may have been made in deep water, as was planned, but not carried out, at Bikini. It was recalled that, in addition to an aerial explosion and a second in shallow water, a third Bikini test—a deep underwater explosion—was tentatively set for the spring of 1947. This, however, was called off.

Other sources, drawing signifi-

Continued on Page 2, Column 2

SECRET TEST MADE OF ATOMIC WEAPON

Continued From Page 1

cance from the commission's refusal to disclose the date, thought the experiment might have been conducted in the air, and might have involved a cloud. Results of such an experiment, it was pointed out, could have been observed from remote points and linked to an atomic weapon test were the date known.

Nothing, however, could be confirmed, and the commission said bluntly that no further information would be forthcoming for the time being.

The White House, meanwhile, announced that President Truman would renominate the five members of the Atomic Energy Commission, headed by Chairman David E. Lilienthal.

Charles G. Ross, presidential press secretary, said that Mr. Lilienthal and his four associates had all agreed to accept new appointments beginning in August. It was learned that the nominations were being made at this time to give the Senate ample time to consider them for confirmation before adjournment now scheduled for mid-June.

The five members were initially appointed for one-year terms, but under reappointments they will serve for periods running from one to five years. This is to provide for one vacancy occurring each year.

Besides, Mr. Lilienthal the present members are Robert F. Bacher, Sumner T. Pike, Lewis L. Strauss and W. W. Waymack. Mr. Ross would not say the length of the new term to which each commissioner would be nominated.

operation conditions is necessary to improved design," the report added.

It also noted that "the scientific and technical operations of the proving ground will provide new fundamental data and a broader understanding of the phenomena of nuclear fission for peaceful as well as for military application of atomic energy."

Eniwetok, the commission has explained, was selected as the site for atomic weapon experiments because it provided more land surface than did Bikini, scene of the naval test, "Operations Crossroads." This was deemed necessary to house the great number of instruments required.

Also Eniwetok, with about 145 inhabitants, had the smallest population of suitable sites considered. The atoll was also desirable for the purpose because of the hundreds of miles of open sea in the direction in which the prevailing winds would carry radio-active particles.

The five preceding atomic explosions were made as follows: (1) In

the New Mexican desert, July 16, 1945; (2) Hiroshima, Aug. 6, 1945; (3) Nagasaki, Aug. 9, 1945; (4) Over Bikini lagoon, July 1, 1946, and (5) In the shallow waters of Bikini lagoon, July 24, 1946.

THE NEW YORK TIMES WHERE ANOTHER ATOMIC BOMB WAS EXPLODED



The sixth atomic bomb sent up its great geyser of smoke and flame in the vicinity of Eniwetok Atoll. The time was not specified.

engineering perfection of improved designs." "Thorough testing of weapons and components under simulated

Congress to Get Secret Report

In its announcement today, the commission said a secret report of the recent test would be given the Joint Committee on Atomic Energy of Congress, and added:

The test was the first to be announced since those at Bikini just two years ago. But the commission would not reveal the date "for security reasons." It said a secret report of the test would be given to the Joint Committee on Atomic Energy of Congress, and added:

"The test was conducted under the full security restrictions of the Atomic Energy Act of 1946, and pursuant to the provisions of the act, the public issuance of further information concerning the test is not permissible at present."

In its second report last July, the commission said it was setting up proving grounds in the Pacific "for routine experiments and tests of atomic weapons." Later, on Dec. 1, it announced that Eniwetok Atoll had been selected for the tests, and that construction of installations had started.

The staffing and organization of the proving ground were announced Dec. 22, and one day before the close of the year public notice was given that hazards would exist in a defined area around Eniwetok after Jan. 31, and throughout 1948.

"In the late winter months Joint Task Force 7 comprised of units of the Army, Navy and Air Force completed construction at the proving ground," the commission reported today. "Extensive instrumentation was installed for the use of the scientific and technical group."

The commission's third report to Congress last Jan. 31 discussed the agency's program of weapons research. It said "the principal goal in this field is the scientific and

3 NEW ATOMIC ARMS IN ARSENAL OF U. S. PASS SEVERE TESTS

Weapons of 'Improved Design'
Successful 'in All Respects,'
White House Discloses

MISSILES TRIED ON ATOLL

Truman Approves New Nuclear
Project—Lilienthal Term to
1950 Voted by Joint Body

By ANTHONY LEVIERO

Special to THE NEW YORK TIMES.

WASHINGTON, May 17—The White House announced today that three "improved" atomic weapons had been fired with complete success in recent experiments in Eniwetok Atoll in the Pacific.

This was the first time this country had officially disclosed that it had at least three different kinds of atomic weapons.

The results of the tests, according to other authoritative sources, transcended all other developments in nuclear energy since the dawn of the atomic age, five and a half years ago.

What took place in the vast "fortress of the atom" in the Marshall Islands will lead to a reshaping of the military phase of the atomic-energy project, it was said.

Eyewitness Describes Details

President Truman heard the details of the secret experiments today from an eyewitness. The whole Atomic Energy Commission, headed by Chairman David E. Lilienthal, went to the White House to report.

[The United Nations Atomic Energy Commission voted Monday to suspend all work toward international control of atomic power. Only the Soviet Union and the Ukraine voted "No."]

[In Washington, the Senate-House Committee on Atomic Energy approved extension of the terms of David E. Lilienthal, chairman of the Atomic Energy Commission, and the four other Commissioners to June 30, 1950. The committee thus rejected President Truman's request for terms of one to five years for the Commissioners, as provided by law]

Dr. Robert F. Bacher, the one physicist in the group that called at the White House, described in detail to Mr. Truman the significance of what he had seen as a task force of 10,000 scientists, soldiers, sailors and airmen carried out this country's second great, controlled experiment with atomic explosives in the Pacific.

After the Commission had left, the White House announced that President Truman had approved plans for new atomic developments in the light of the results achieved in the recent tests.

'Improved Design' Noted

From the White House announcement and from disclosable data obtained from other official sources the significance of the tests was summarized as follows:

(1) Each weapon caused a nuclear explosion, like the atomic bomb. Thus the weapons were in the categories of bombs, projectiles or torpedoes. They were described merely as "three atomic weapons, each of improved design," and official elucidation did not go beyond the explanation that each was different from the other. How they were used—whether in the air, on the surface, or underwater—was not disclosed. Only one atomic weapon, the bomb, has ever been officially acknowledged by

Continued on Page 14, Column 3

type; and the only previous distinction made between atomic weapons was that the bomb exploded over Nagasaki had been more powerful than the one used at Hiroshima.

(2) In consequence of the results achieved in the tests, the atomic-energy project has reached its most important stage since Enrico Fermi and Leo Szilard caused the first successful chain reaction in a laboratory hidden away under the benches of Stagg Field on the University of Chicago campus on Dec. 2, 1942. The controlled splitting of uranium atoms on that occasion assured the feasibility of producing plutonium, the explosive of the atomic bomb.

No Casualties Resulted

(3) The weapons' phase of the atomic program will require reshaping, projecting it into a new and decisive period requiring a year or more.

(4) An extreme degree of coverage by instruments was carried out in the test area to record and measure every possible result and effect of the tests.

(5) There were no casualties in Joint Task Force 7, which carried out the tests.

After having issued an announcement concerning the tests, the White House also released a letter that President Truman had written to James Forrestal, Secretary of Defense, commending the members of the task force "for a job well done."

The announcement relating to the tests follow:

The President today received from the United States Atomic Energy Commission a report on tests of atomic weapons conducted at the Commission's proving ground at Eniwetok Atoll in the Marshall Islands. The tests were held pursuant to approval of the President given in June, 1947. The first series of the tests are now completed.

The Commission reported that the tests, involving three atomic weapons, each of improved design, were successful in all respects, and that the results indicate very substantial progress. The President gave general approval of Commission plans for steps it proposed to initiate at once for further nuclear development, based upon information gained from the tests.

As previously announced by the Commission, the tests were conducted under the security provisions of the Atomic Energy Act, and information as to the scientific results and technical details of the tests cannot be made public at this time. The area of the proving ground, as previously defined, remains closed to unauthorized persons.

The Secretary of National Defense and the Atomic Energy Commission have authorized statements of acknowledgment of services of the personnel engaged in the tests, for release by the military scientific leaders of the project upon their return to Honolulu tomorrow.

The date of the tests has been a closely guarded secret, and the

first cryptic announcement that they had been held was made on April 19. It was learned at the time that the Eniwetok tests were not a continuation of the historic Crossroads explosion of an atomic bomb over a naval fleet in 1946. Two phases of that operation were abandoned.

Part of Task Force 7 will arrive in Honolulu tomorrow, and Mr. Lilienthal said Lieut. Gen. John E. Hull, its commander, and Capt. James R. Russell of the Navy, director of the weapons branch of the Atomic Energy Commission, may have more to say upon their arrival there. Captain Russell was test director.

Besides Dr. Bacher, Mr. Lilienthal was accompanied to the White House by Commissioners Sumner T. Pike, vice chairman; Lewis L. Strauss and William W. Waymack, and Carroll L. Wilson, general manager of the Commission. "This mission," said President Truman in his letter to Mr. Forrestal, "is an outstanding example of cooperation between the agencies responsible for the military defense of the nation and those responsible for the scientific and technical development of an important means of defense."

Mr. Truman also said he was sure that Mr. Forrestal shared "my feelings of gratification at the accomplishments of the Commission's Los Alamos scientific laboratory, as indicated by the results of the test program." He asked the Commission to convey his commendation to all civilians engaged in the work leading up to the tests. The first atomic bomb was fabricated at Los Alamos.

MEMORANDUM

July 7, 1948

TO: W. Allen-8,9	Crier-3,4,5,6,8,9,10	Ogle-2,6,7,9
Bradbury	Hodberg-10	Reinas-3,6,8,9
Brixner-8,9,10	Henderson	Richardson-7,9
Burriss-4	King-3,6	Sanderson-2,6
Butler-7,9	Krause-2,3,4,5,6	Smith-2,5,6,10
Carde	Landshoff	Strain-2,4,6
Clark-8,9,10	Linenberger-3,5	Suydam-2,3,6,10
Durand-2,3,6	Manley	Taschek-2,3,5,6
Edgerton-2,3,5,6,8,9	Mark-2,3,6	Teller-2,3,6
Fussell-3,4,6,10	Mayer-2,3,6	Watt-2,6
Graves-3,5,6,10	Noreson-4,5	Wyckoff-8,9
	Mullaney-7,9	Zadins-4,7,9

FROM: Darol Froman

SUBJECT: DISCUSSION OF CERTAIN RESULTS AND MEASUREMENTS FROM OPERATION SANDSTONE

There will be meetings as indicated on the schedule attached to discuss certain results and measurements from the Sandstone Tests. It is requested that, if possible, you attend those meetings indicated by numbers following your name on the distribution list. We are attempting to keep the meetings small, but please attend any of the others in which you feel that you may be able to contribute or assist. The secretary at each meeting will summarize the discussion and copies of his notes will be supplied interested parties. Further meetings may be scheduled on Saturday if necessary.

It is requested that the chairman at each meeting keep the discussion to the point, as there are other meetings at which matters not too closely related may be discussed. The primary speaker at each meeting is requested to speak about one-half hour describing experimental procedure, summarizing results, discussing errors, methods, etc. This will leave half or three-quarters of an hour for discussion.

The internal structure of the test weapons will not be discussed at these meetings.

Darol Froman
 Darol Froman

DF:mm

WHEN SEPARATED FROM ENCLOSURES, HANDLE

THIS DOCUMENT AS Unclassified(INSERT PROPER CLASSIFICATION
IF UNCLASSIFIED, SO STATE)

RESTRICTED

SCHEDULE OF MEETINGS

			<u>Location</u>	<u>Chairman</u>	<u>Secretary</u>	<u>Primary Speaker</u>
1.	Thurs. 0800-0830	General Meeting	B-223		Zadina	Froman
2.	Thurs. 0830-1000	Alpha Rossi	B-223	Froman	Suydam	Krause
3.	Thurs. 1030-1200	Alpha Teller	B-223	Graves	Reines	Edgerton
4.	Thurs. 1315-1445	Transit Time	B-223	Reines	Nereson	Strain
5.	Thurs. 1530-1630	Coordination of Timing (Operation Sandstone)	B-223	Graves	Taschek	Grier
6.	Fri. 0800-0930	Combined Alpha Rossi and Teller	B-223	Froman	Suydam	Taschek
7.	Fri. ^{THURS.} 1530-1630 1030-1200	Bolometer Measurements	B-223 B-103	Ogle	Zadina	Butler and Richardson
8.	Fri. 1030-1200	Photographic Measurements	B-223	Clark	Mullaney	Brixner
9.	Fri. 1315-1445	Combined Bolometer and Photographic (Optical Radiation)	B-223	Clark	Mullaney	Reines
10.	Fri. 1530-1630	Coordination of Timing (Future)	B-223	Froman	Hedberg	Fussell

*Gamma Ray meas.
Pressure meas.
Seismic meas.*

RESTRICTED



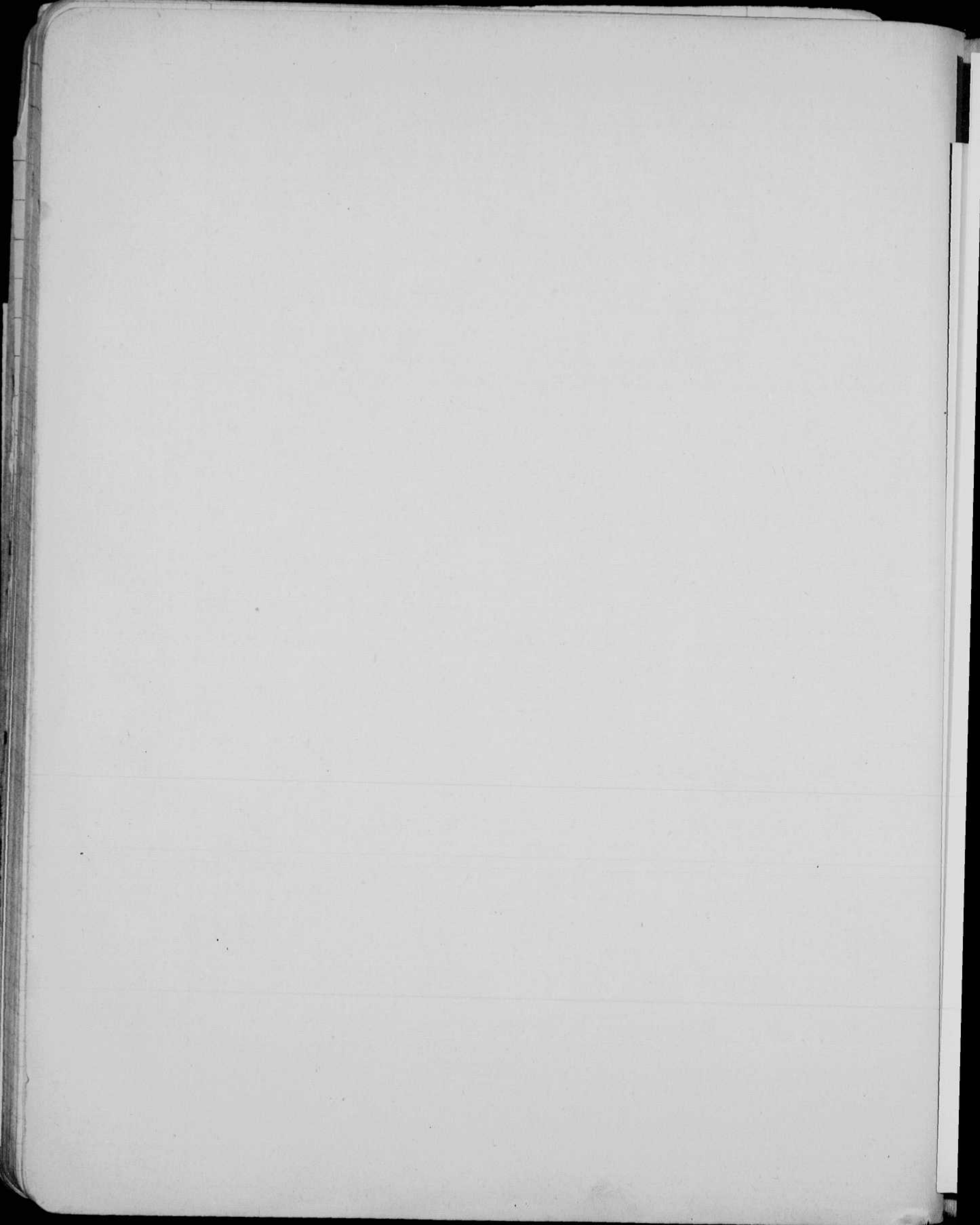

Notebook # 18

Filming and Separation Record

1 unmounted photograph(s)

 negative strip(s)

 unmounted page(s)
(notes, drawings, letters, etc.)

was/were filmed where originally located between page and .
inside back cover

Item(s) now housed in accompanying folder.





