

MIT LIBRARIES



3 9080 02486 5690



LIBRARY
OF THE
MASSACHUSETTS INSTITUTE
OF TECHNOLOGY

The

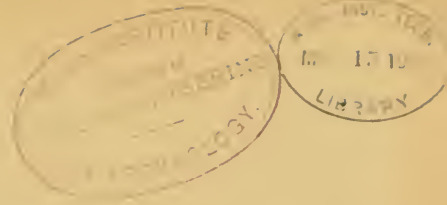

Street Railway

Gazette.

VOLUMES I AND II.

| | | | | | | |
|----------------|---|---|-----------------------------|---|---|--------------|
| <i>Vol. I.</i> | - | - | <i>January to December,</i> | - | - | <i>1886.</i> |
| <i>Vol. II</i> | - | - | <i>January to December,</i> | - | - | <i>1887.</i> |

THE WRIGHT-MONROE COMPANY,

NEW YORK.

CHICAGO.

BOSTON.

INDEX TO LEADING ARTICLES, ETC.—VOLUME I.

| A | PAGE. |
|---|--------------------|
| Absurd demands | 140 |
| Accidents | 330 |
| Ackley, Thos. W. | 242 |
| Advertisement lost | 32 |
| Allegorical car decoration | 14 |
| American Street Railway Association, 42, 239, 268, 271, 292, 304 (annual convention), 312. | |
| An important decision | 170 |
| Aromatic car heaters | 103 |
| Around the barns | 174 |
| Association reports and papers | 42 |
| B | |
| "Because" | 43 |
| Biographical sketches, with portraits and autographs:—Ackley, Thos. W., 303; Blake, Jas. K., 3; Cregier, DeWitt C., 95; Hanscom, Wm. Wallace, 159; Hathaway, Chas., 223; Johnson, Tom L., 127; Kerper, G. B., 283; Faine, Wm. H., 257; Richardson, Wm., 61; Stroud, D. W., 323; Walsh, Julius S., 31; Yerkes, Chas T., 191. | |
| Blackpool electric tramway | 34 |
| Bomb murderers | 270 |
| Bonfield, Capt. | 76 |
| Brave words | 203 |
| Bright idea (A) | 105 |
| Broadway R.R. legislation | 237 |
| Broadway, A trip beneath | 230 |
| Brooklyn Bridge | 16, 62, 109, 168 |
| Business Notes | 275, 299, 321, 343 |
| Buyer and seller | 15 |
| C | |
| Cable crossing | 17 |
| Cable grips | 203 |
| Cable railways | 44, 63, 198, 202 |
| Automatic brake | 297 |
| Improved gripping device | 330 |
| Mt. Adams and Eden Park inclined | 284 |
| New method of gripping and crossing | 128 |
| Propulsion | 198, 200, 228, 260 |
| Ramsden's conduit | 105 |
| Switching | 196 |
| Car decoration (Allegorical) | 14 |
| Cave of Adullam, (In the) | 336 |
| Cheap fares to healthy localities | 284 |
| "Chevalier d'industrie" | 172 |
| Chicago City Railway Co. | 10 |
| Chicago Passenger Railway Co. | 42 |
| Chicago's street railway future | 42, 43 |
| Cincinnati ("Trouble in") | 71 |
| Compressed air motor | 237 |
| Conductors' and drivers' uniform | 237 |
| Conductors reciprocate (Let the) | 65 |
| Construction, equipment and maintenance of American street railways, 6, 7, 36-39, 68-70, 98-101, 134-136, 160-115, 192-194, 224, 258. | |
| Convict (Jaehne) | 141 |
| Corporations, firms and individuals | 107 |
| Correspondence | 204, 336 |
| Cregier DeWitt C. | 18, 40, 95 |
| Crossing cables | 17 |
| D | |
| Damages | 140 |
| Defeat, not a failure | 293 |
| Door fastener (Haycox) | 104 |
| Dummies and other motors | 75 |
| E | |
| Earth in the stable | 33 |
| Electric railways | 97, 109, 133 |
| Baltimore and Hampton | 201 |
| Kansas City | 226 |
| Minneapolis | 195 |
| Sprague system | 324 |
| Toronto exhibition | 267 |
| Elevator and the elevated | 203 |
| Elevated railways, 65, 66, 130, 170, 267, 284, 238, 292, 295, 313, 331. | |
| Enslilage (horses and mules fed on) | 231 |
| European notions | 44 |
| Ex-presidents | 269 |
| F | |
| Fare-box and lantern (Combined) | 62 |
| Fare collection (Marshall register) | 102 |
| Fares (New York street car) | 166 |
| Fares reduced in New York | 303 |

| | PAGE. |
|---|------------------|
| Fare registers | 11 |
| Feminine vengeance | 5 |
| Fletcher car brake | 169 |
| Foreign items, 50, 82, 113, 147, 179, 210, 242 | |
| Forthcoming papers of value | 12 |
| Franchise without bidders | 293 |
| G | |
| Gigantic enterprise, (A pitiable sequel to a) | 42 |
| Gould's (Jay) invention | 336 |
| Grappling the grip | 260 |
| Great strike in New York | 76 |
| H | |
| Haddox car driver's stool | 295 |
| Hanscom, Wm. Wallace, | 159, 198, 228 |
| Harness (Improvements in) | 317 |
| Hathaway, Chas. | 223 |
| Hay in cars | 73 |
| Heat and health | 70 |
| Heating horse cars | 237 |
| Heating railway stations and waiting rooms | 165 |
| "Here they are" | 309 |
| His name deserves to live, (Supt. Martin) | 109 |
| History of street railways | 294, 314 |
| Homes | 34 |
| Hoof rasping | 109 |
| Horse car stove | 32 |
| Horse and man | 49, 104 |
| Horse, The New York car | 109 |
| Horse (A plea for the) | 40, 67, 167, 196 |
| Horse power | 8 |
| Horse power, and the power of a horse | 101 |
| Horse power used in propelling street cars | 36 |
| Horse railroad repairs | 234 |
| Horse shoe (Removable) | 96 |
| Horse (Save the) | 317 |
| Horse shoeing | 317 |
| I | |
| Illustrations:—Baldwin street steam motors, 264; Baltimore and Hampton electric railway, 201; Bissett's passenger indicator, 291; Blackpool electric railway, 34, 35; boiler and radiator, 166; cable railway propulsion (Hanscom), 198, 200, 228; car lamp (new), 128; combined fare box and lantern, 62; cross over, 163; Dietrich's improved cable gripping device, 330, 331; early elevated railways, 66, 67; elevated railway (Mack's) 65, (Meigs's) 130, 131; Fletcher car brake, 169; Good-enough shoe, 10; gripping and crossing cables (new method of), 129; Haddox car driver's stool, 295; Haycox door fastener, 104, 105; heating horse cars, 237; heating plant (stations and waiting rooms), 165; "Here they are" (convention cuts), 309, 310; horse's hoof, 167, 197; lamps and lamp holders (Sherburne and Co.'s), 316, 317; Marshall register, 102; Mt. Adams and Eden Park inclined railway, 284-290; New York district railway, 4, 5; North Hudson County cable railway (mechanical arrangements), 63, 106; Ober car ventilator, 263; Pearson's (Everett) noiseless motor, 316; Pendleton's electric motor attachments, 267; rails, chairs and cross-ties, 93, 101, 134, 136, 162; Ramsden's cable railway conduit, 105; "Reliable" sand box, 298; removable horse shoe, 96; Robinson's automatic brake for cable cars, 297; Roff Emery brake, 33; salter, 259; sash holders, 224; scrapers, 224, 258; snow plow, 225; Sprague electric railway, 324, 328; spring edge seats, 10; standard street railway locomotive, 97; steel tired (wrought iron) wheels, 200; street steam car frame, 168; summer cars, (recent designs in, Brill's), 137, 138, 195; switches and turn tables, 164; Wharton's bending machine, 162; White's "L" road, 295; Warswick Journal box, 33. | |
| Important decision | 170 |
| Industrial education | 270 |
| J | |
| Johnson, Tom L. | 18, 32, 127 |
| K | |
| Kansas City Electric railway | 226 |
| Kerper, G. B. | 283, 293 |
| Kings County Elevated R.R. Co. | 238 |

| | PAGE. |
|--|--------------------|
| Labor and capital, Depew on | 172 |
| Legal decisions | 106 |
| Labor dispute | 106 |
| Labor legislation | 270 |
| Labor question (A) | 236 |
| Lady passenger | 139 |
| Lake, Jas. K. | 18 |
| LaSalle street tunnel | 205, 206, 235 |
| Locomotive (standard) for street railways | 96 |
| M | |
| Meigs elevated railway | 130, 132 |
| "Mills of God," (The) | 128 |
| Motors | 75, 237, 263, 270 |
| Motors, Dummies and other | 75 |
| Motors, Method of attaching electric | 267 |
| Motors, Noiseless steam | 316 |
| Mt. Adams and Eden Park street railway | 297 |
| Municipal ordinances, Conditions in | 236 |
| N | |
| Nahant (happy) | 16 |
| New corporations | 206 |
| New Literature | 337 |
| New York Arcade railway | 141, 170, 206 |
| New York and Brooklyn bridge | 169 |
| New York car horse | 109 |
| New York district railway | 4 |
| New York great strike | 76 |
| New York Suburban Rapid Transit railroad | 167 |
| Next | 17 |
| "Nigger (A) in the fence" | 142 |
| North Chicago City Railway (Sale of) | 78, 110 |
| North Chicago City Railway Co. | 267, 329 |
| North Hudson County (cable) railway | 63, 196 |
| Notes and items, 51, 82, 114, 147, 179, 211, 242, 275, 301, 321, 343. | |
| O | |
| Ohio State Tramway Association | 334 |
| Ordinances, Conditions in municipal | 236 |
| Ordinance, A specimen | 15 |
| Our boys | 235 |
| Our menu | 12 |
| Our object | 12 |
| Our personnel | 12 |
| Oyer and terminer | 142 |
| P | |
| Paine, Col., (Justice to) | 65 |
| Paine, Wm. H. | 257 |
| Passenger, The lady | 139 |
| Patent's | 225, 278, 298, 337 |
| Peck, Labor Commissioner | 45 |
| People's Pass. Ry, Philadelphia (Sale of the) | 41 |
| Personals:—Adams, Chas. Francis, 239; Andrews, Frank H., 299; Arthur, Chester A., 207; Burke, A. M., 45; Cannon, C. W., 175; Clooney, B. A., 143; Cregier, DeWitt C., 18, 40, 207; Cross, Bert, 337; Daft, Leo, 143; Davis, W. E., 175; Edison, Thos. A., 239; Everett, H. A., 271; Goodrich, S., 271; Hall, Dunn, 45; Hamilton, Geo. W., 175; Hanna, J. B., 271; Hanscom, Wm. W., 239; Harris, John, 175; Hathaway, C., 271; Hayward, A. H., 271; Hazzard, 175; Hearty, Mr. and Mrs. Robt., 17; Johnson, Tom L., 18, 32, 271; Jones, Daniel A., 45; Kilgour, John, 271; Lake, Jas. K., 18; Lerner, F. T., 143; Littell, H. H., 271; Luce, R., 299; Mattern, Robt. G., 45; Paine, Col., 65; Parsons, W. B., 337; Payne, Geo. W., 42; Peck (Commissioner), 45; Powell, E. R., 239; Richards, Calvin A., 170; Richardson, Wm., 18, 45, 61; Richmond, Jas. A., 143; Root, Henry, 271; Russell, C. W., 175; Sanborn, L. W., 239; Scarff, Chas. W., 207; Sharp, Jacob, 110; Smith, Holroyd, 299; Sniffen, L., 271; Theodry, Fred L., 110; Townsend, John, 175; Turner, V. C., 271; Vander Wyde, Prof. P. H., 207; Van Nostrand, David, 207; Vredenburg, Mrs. Letitia V., 207; Wredener, Peter A. B., 207; Wright, Augustine W., 110, 143. | |
| Pointers, 18-24, 45-50, 79-82, 110-113, 143-146, 175-179, 207-210, 239-242, 271-275, 299-301, 319-321, 338. | |
| Prediction (A) | 173 |
| President's reverie | 108 |
| Princess in a street car | 201 |
| Progress of working classes | 173 |

INDEX TO LEADING ARTICLES, ETC.—VOLUME I.—CONTINUED.

| | PAGE | | PAGE | | PAGE |
|--|----------------|---|------|--|----------|
| "Public (The) is a fool"..... | 74 | Steel rails (To utilize old)..... | 11 | the Brooklyn strikes, 205; causes and effects of strikes 43; protection against strikes 109; strikes against the public, 75. | |
| Public, Strikes against..... | 75 | Straw (Use of)..... | 72 | Stroud, D. W..... | 323 |
| R | | | | | |
| Railway register decision..... | 50 | Stock assessments..... | 293 | Suburban Rapid Transit RR. Co. of New York..... | 167 |
| Rambblings in Dixie..... | 40, 105 | Stoves in street cars..... | 32 | Summer cars, (recent designs in) 137, 138, 195 | |
| Ramsden's cable railway conduit..... | 105 | Street cars;—Bodies (form of) 315; brakes (steam) 313; etiquette 173; hay (in), 73; heaters (aromatic), 103; heating (Gold system), 232; lamps and lamp holders, 316; Mexican mules, 206; new lamps, 128; nuisances, 205; opening doors, 313; passenger indicator (Bissett's), 291; propriety of Sunday travel (in) 170; propulsion in Great Britain 174; recent designs (summer cars), 137; steam, 168; Sunday law, 323; ventilation, 263. | | T | |
| Rapid transit (in cities)..... | 130, 132, 266 | Street corner colloquies..... | 139 | Third ave. RR. (New York)..... | 239, 332 |
| Rapid transit in Chicago..... | 171 | Street railroading..... | 14 | Tramway (Blackpool electric)..... | 34 |
| Rapid transit—the Suburban Railroad of New York..... | 167 | Street railways;—Arcade, 140, 170, 206; Atlantic ave., 333; Broadway, 237 292, 329, 333; Buffalo, 235; building, 290; Cambridge (Mass.) 332; Chicago passenger, 332; finances, 171; franchises, 298; future in Chicago, 42; genesis (Chicago), 312; Gest st., 333; hills in Cincinnati 297; history, 294, 314; Jersey City and Bergen, 333; medical attendance, 128; New Orleans (morality), 296; New Orleans and Carrollton, 329; New York District 333; patents, 225, 278, 298, 377; problems, 17; Second ave. (New York), 239. | | Tramways and health..... | 13 |
| Reaping the whirlwind..... | 140 | Strikes, 13, 42, 71, 76, 78 (New York), 105, 235; analysis of strikes, 64; Beecher on | | Tramway difficulties..... | 64 |
| Regulating the universe..... | 172 | | | Trip beneath Broadway..... | 230 |
| Removable horse shoes..... | 96 | | | Triple Thermic Motor Co..... | 200 |
| Richardson, Wm..... | 18, 39, 45, 61 | | | Triumphant democracy..... | 204 |
| Roads and franchises (New)..... | 62 | | | U | |
| Roff—Emery brake..... | 33 | | | Underground railways..... | 131, 266 |
| S | | | | | |
| Salt on rails..... | 235 | | | Unions..... | 13 |
| Salutatory..... | 12 | | | Upper New York..... | 205 |
| Same canoe (The)..... | 107 | | | V | |
| Sand box ("The Reliable")..... | 298 | | | Veterinary (Pronunciation of)..... | 9 |
| Sash holder, Improved..... | 224 | | | W | |
| Smoking on cars..... | 235 | | | Walsh Julius S..... | 34 |
| Steam traction for street railways..... | 168, 264 | | | Wheels, Steel-tired wrought iron center..... | 200 |
| Seats (Spring edge)..... | 10 | | | Where they drew the line..... | 238 |
| Secretary of the Navy as a railroad man..... | 16 | | | Whips (No)..... | 39 |
| Shoes (Extra)..... | 65 | | | Worswich journal box..... | 33 |
| Shoing (Winter)..... | 10 | | | Y | |
| Solo on a new horn..... | 106 | | | Yerkes, Charles T..... | 191 |
| Springfield grown critical..... | 14 | | | | |
| Standard street railway locomotive..... | 96 | | | | |
| Steam traction..... | 264 | | | | |

INDEX TO LEADING ARTICLES, ETC.—VOLUME II.

| | PAGE | | PAGE | | PAGE | | | |
|--|-----------------------------|---|---------------|--|---------|--|--|--|
| A | | | | | | | | |
| Adams' elevated railway..... | 241, 243 | Coming power to move street cars, (What is it?)..... | 50 | lowed to slumber, 10; legal difficulties, 165; legislation for elevated railways (Illinois, 54; life's romantic side, 11; Manhattan elevated railway bonds 250; Mayor Hewitt, 120; Meyer's bill, 76; mustangs, 144; New Orleans "unsold franchise," 11; "progressive Los Angeles," 32; railway jubilee in Paris, 77; railway seat spring (new form), 77; Reckenzaun's storage battery, 228; Ries' electric railway system 184; St. Joseph, 98; Senator Eckard's bill, 54; Shippe's invention, 165; something new in locomotives, 77; storage batteries 144 184, 228; Story's miserable story, 121; street cars in India, 77; street railway convention (Philadelphia), 184, 288; strike at John Stephenson Co.'s, 184; strikes, 32; suits for damages barred by Judge Gill, at Kansas City, 204; summer cars, 120; temptation and ruin of a private secretary, 250; Topka "boomed," 99; transfer tickets, 54; U. S. Mail, 228; West Division (Chicago) st. ry. sold, 164; Wharton's electric eight-wheeler, 250; "who owns the streets," 76; Wichita, 98; "Yerkes in the courts," 228. | | | | |
| Adams, J. W., (Inventor and Mechanic)..... | 250 | Connelly motor..... | 116 | Edison's electro-metronograph..... | 201 | | | |
| American cable railway construction, 74, 75, 87-89, 131-133, 158-161, 186, 187, 195, 196. | | Construction, equipment and maintenance of American street railways, 2-5, 27, 28, 45-48, 66-69 94-95, 109-113, 141, 142, 166, 236-238, 249. | | Electric railways:—Bentley-Knight, 34-37; Daft electric railways, 175, 176; electric railway bill, 93; European and American lists, 115; in San Francisco, 137; Irish's sealed conduit, 245; Julien cell, 140; Ries' (underground conduit) 200, (adhesion) 202, (railway system) 203; Sprague motors, 165; Van Depoele's system, 155, 161; storage batteries, (Reckenzaun) 150-183; (Weiss) 185; (Woodward) 187; (worthless) 232; Wharton's electric motor exhibition, 183. | | | | |
| American Street Railway Association, 100, 176, 196, 197, 218-234, 231 (associate members), 233 (banquet.) | | Convention papers criticised..... | 252 | Electric transportation, future of..... | 179 | | | |
| Ammonia gas as a motor..... | 140 | Correspondence;—Cable railways, etc., in St. Louis, 199; Concord eight-wheel horse cars, 244; height of draw bar, 57; rapid transit in St. Louis, 185, 186; Reckenzaun motors, 244; Wharton's eight-wheel electric car, 244. | | Electric welding and tempering metals..... | 201 | | | |
| Arcade Railway, New York, (city owns the streets),..... | 77 | Coupling and uncoupling cars (New device for)..... | 247 | "Electricity as a motive power,"..... | 220-224 | | | |
| Arcade Rapid Transit Co., Chicago..... | 81 | Creger rail..... | 49 | Electro-locomotive (The coming)..... | 194 | | | |
| B | | | | | | | | |
| Baker brake..... | 246 | Crossing (New) for street railways..... | 7 | Elevated railway decisions..... | 167 | | | |
| Battery Park..... | 136 | D | | | | | | |
| Belt line (New York) horses, etc., burnt..... | 115 | Daft electric railways..... | 175, 176, 244 | Elevated railway fares (New York)..... | 185 | | | |
| Bentley-Knight electric railway, 34-37, 143, Biographical sketches, with portraits and autographs;—Bailey, John E., 239; Hallidie, Andrew Smith, 107; Holmes, Chas. Butler, 217; Hutchinson, Robert, 66; Lyon, Lewis, 19; Richardson, Wm. J., 1. | | Double deck cars..... | 143 | Elevated railway legislation..... | 116 | | | |
| "Boodle"..... | 12 | E | | | | | | |
| Books, etc..... | 44, 86, 129, 154½, 192, 193 | Editorial paragraphs;— Adams street railway bill 76; advantages of the cable system, 32; "American cable railway construction," 32, 54; Arcade Railway Co. (New York), 98; Boston 144; British tramways, 33; Brooklyn cable system, 11; cable railways for Minneapolis 90; cable propulsion, 184; cable railways (shocks), 203; cable traction "steam power" 77; cable tramways in England, 77; Canada 144; conductors' ball, 10; constitutional reform (New York), 54; court of appeals (New York), 99; Edison's electric motor, 54; electric motor at fault 204; electric railways, 10, 54, 164, 228; elevated railway for Broadway, New York, 99; (for Philadelphia) 120, 121; finest street cars, 164; Forepaugh (Adam), 65; "gone to the courts," 10; honesty unrewarded in Boston, 250; house removing (Judge McGill), 99; Howard's gossip 54; "huge deal in dirt" 121; Hutchinson (Kans.), 120; inventors extremely busy, 250; John-on's steel rails 120; Judge Van Brunt's decision (city owns streets, New York Arcade Railway), 77; Kansas City Electric Ry. Co. assigning, 250; Kansas City (165) and Wyandotte, 77; laws al- | | | | | | |
| Boston letter..... | 56 | F | | | | | | |
| Boston street railways..... | 240 | G | | | | | | |
| British tramways..... | 33, 80 | H | | | | | | |
| Business notes, 18, 44, 64, 86, 106, 130, 154½, 174, 193, 236, 261, 262. | | I | | | | | | |
| C | | | | | | | | |
| Cable railway construction (American), 74, 75, 87-89, 131-133, 158-161, 186, 187, 195, 196. | | J | | | | | | |
| Cable railway construction in Melbourne, Australia..... | 78 | K | | | | | | |
| Cable railways in Great Britain..... | 249 | L | | | | | | |
| Cable railways..... | 109, (Hanscom) 197 | M | | | | | | |
| Cable roads (Cheap)..... | 167 | N | | | | | | |
| Cable system, (Advantages of)..... | 32 | O | | | | | | |
| Caldwell's concrete mixer..... | 113 | P | | | | | | |
| Car driver's views..... | 157 | Q | | | | | | |
| Car fares in copper..... | 168 | R | | | | | | |
| Car heater (New)..... | 11 | S | | | | | | |
| Center bearing and other rails..... | 100 | T | | | | | | |
| Chicago wants rapid transit..... | 239 | U | | | | | | |
| Chicago Metropolitan (Underground) R. R. Co..... | 169 | V | | | | | | |
| Chicago West Div. Ry. (Sale of the), 169, 188, 212 251 | | W | | | | | | |
| City of London and Southwark Sub-way Co..... | 146 | X | | | | | | |

INDEX TO LEADING ARTICLES, ETC.—VOLUME II.—CONTINUED.

| F | PAGE. | N | PAGE. | Pole (B. C.) street car motor | 11 | R | PAGE. | | |
|---|-----------------|--|--------------------------------|---|---------------|---|---------------|-------------------------------|---------|
| Fire insurance, (Committee)..... | 220, 224, 231 | Newburgh's street railroad (opened)..... | 11 | Pullman's work..... | 44½ | Railway (Paris) jubilee, 1887..... | 121 | | |
| Foreign street railways..... | 18, 64 | New cable railway system (McLauflin's)..... | 247 | Rapid transit facilities in New York and Boston (Galloupe)..... | 148 | Rasmussen cable system..... | 21-26, 177 | | |
| Franchise expiring (New Orleans)..... | 109 | New grip for cable railways (Wiechardt's)..... | 248 | Reckenzaun on storage batteries..... | 180-183 | Ries' electric motors..... | 162, 163, 239 | | |
| G | 38 | New York (State) Street Railway Association, 208-211, (street railways) 138. | | Ries' electric railway brake..... | 134 | Ries' tractive adhesion..... | 231 | | |
| H | 38 | New power..... | 37 | Riley elevated railway system..... | 178 | Rischmuller cable grip, etc..... | 248 | | |
| Height of draw bar..... | 57 | O | 146 | Road construction..... | 227 | Rubber-covered steps for cars..... | 5, 6 | | |
| History of street railways, (continued from Vol. 1)..... | 8, 9, 29, 70-72 | Obituary—Jackson Bailey..... | 243 | Rules, discipline, uniforms, etc..... | 251 | | | | |
| How street railways of Berlin..... | 102 | Ohio State Tramway Association..... | 187 | | | S | | | |
| How and when shall it be done..... | 139 | Our London letter..... | 145 | | | Sand boxes (improvements in)..... | 57 | | |
| I | 202 | P | 167 | Sand boxes (for open cars) 137, (for closed cars) 198. | | Sanding tracks..... | 116 | | |
| Increasing tractive adhesion of electric motors..... | 202 | Pardy's pneumatic street railway..... | 167 | Sand Francisco riots..... | 37 | Sargent safety rod coupler..... | 157 | | |
| Innovation in horse railways..... | 145 | Patents..... | 13, 38, 56, 86½, 150, 174, 193 | Sharp points..... | 168 | Siam-Bangkok city tramway..... | 192 | | |
| Inspectors for elevated railroads (New York) Illustrations:—Adams' elevated railway, 241-243; Baker brake, 246; Bentley-Knight electric railway, 34-37; cable railways, 74, 75, 87-89, 131-133, 158-160, 195, (Rasmussen sprocket wheel cable system) 21-26; car horse, 110, 112; concrete mixer (Caldwell's), 113; Cregier rail, 49, 50; crossing (new) for street railways, 7; Daft electric train, 175; draw bar (height of), 27; grip (new) for cable railways, 248; improved device for coupling and uncoupling cars, 247; Irish's sealed conduit electric railway, 245; Julien storage cell, 140; Meigs elevated railway, 52, 53, 92, 93; Messier car brake, 235; Ries' combination conduit (underground), 200, 201; Ries' electric railway brake, 134, 135; Riley elevated railway, 178, 179; sand boxes, (for open cars) 137, (for closed cars) 198, (improvements in) 57; Sargent safety rod coupler, 157; staples (N. Chicago), 67-69, 95; Stephenson's street car (the first), 4, 45-48; steps (rubber covered) for street cars, 5, 6; toe calks (steel), 91; transfer table, 111, (Langdon's), 199; Van Depoele underground conduit, 155; Whitney contracting chill, 235. | 245 | Permanent International Tramways Union, 78, 220. | | "Sixth Annual"..... | 218 | "Small boy" (Iniquitous)..... | 9 | | |
| J | 247 | Personals:—Alexander, M. M., 236, 254; Ames, 122; Baker Geo. A., 253; Barclay, C. M., 122; Barr, 122; Beadle, Ed., 122; Beattie, Hans S., 38; Bergin, Thos., 253; Boyle St. John, 122; Brill, John A., 122; Caldwell, Dr. Geo. B., 187; Campbell, 122; Carlisle, W. K., 122; Carpenter, G. W., 38; Chapman, Orange J., 80; Chase Geo., 253; Churchyard, Jos., 236; Condoover, Dan'l D., 13; Coolidge, 253; Cummings 253; Cunningham 253; Davis A. H., 122; Dickson, Chas. K., 122; Everett, H. A., 187, 211; Foshay, James W., 58; Fuller, Lawson N., 187; Goodrich, C. J., 122; Gosper, Lieut. J. J., 253; Graves R. E., 122; Hain, F. H., 13; Haines, Chas. D., 58; Haines, John D., 38, 102; Hallidie, A. S., 78, 249; Hartzell, Col. J. W., 38; Hathaway, Chas., 168; Hathaway, A. H., 168; Hazard, Col. Rowland R., 13; Hersey, Chas. H., 253; Johnson, Tom L., 211; Jones, J. Russell, 187; Kerper, Geo. B., 211; Lamb, 122; Latham, Judge T. J., 102; Laughlin 122; Lerner, F. T., 122, 211; Littell, H. H., 122, 211; Longstreet, D. F., 122, 168; Lynn, A. W., 168; Mahoney, John, 253; McCulloch, Capt. Robt., 253; McNapp, 122; McNeill, 122; Masson, M. I., 102; Meigs, Capt. Joe V., 253; Moore Allen, 58; Parsons, John B., 253; Pope, Frank L., 122; Potter, O. B., 13; Pullman, Chas. L., 122; Richards Calvin A., 211, 253; Richardson, Wm., 187; Robison, F. de H., 168; Root, Henry, 122; Smith, Melville C., 13; Sprague, F. J., 187, 211; Stiles, Gen. A. K., 102, 187; Sweeney, A. J., 187; Thompson, Hy., 38; Vanderpool, A. J., 187; Van Hoose, J. A., 102; Wagstaff, Ex-Senator, 38; Walsh, Julius S., 168; Watson H. M., 80; Whelan, Frank, 122; Whitney, Hy. M., 168; Windsor, J. L., 122; Wingate, Gen'l Geo. W., 122; Yerkes, Chas. T., 168, 187. | 247 | Phantasms..... | 119 | Smith's "universal" railroad..... | 248 | Sprague electric railway..... | 12, 165 |
| K | 205-207 | Q | 102 | Sprague gearing..... | 235 | Steam omnibus..... | 249 | | |
| Knights of Labor..... | 220 | Picnic (Adams & Westlake's)..... | 165 | Storage batteries (Alleged worthlessness of) 232, (Reckenzaun) 180-183, (Weis) 185, (Woodward) 187. | | Street railways:—California, 96; directory of the world, 144; grand success, 114; employees' association, 166; fire insurance, 220; Maine, 121; Massachusetts, 55; Mexico, 20; New York, 137; San Francisco, 78; St. R's and Boston common, 118; taxation, 220. | | | |
| L | 204 | Pointers, 14-18, 39-44, 58-64, 81-86, 102-106, 122-129, 151-154, 168-173, 188-192, (Siam) 192, 211-216, 253-261. | | Strikes (threatened) averted in Chicago..... | 207 | Strikes defeated..... | 53, 241 | | |
| Legal decision barring damage suits..... | 204 | | | Swem's automatic switch..... | 243 | | | | |
| Legal opinions..... | 204, 219, 251 | | | T | | Toe calks (steel)..... | 91 | | |
| "Lyer" system..... | 72, 156 | | | "Tramway," Origin of the word..... | 79 | Tramways Institute of Great Britain and Ireland..... | 78 | | |
| M | 55 | | | Transfer table..... | 199 | | | | |
| Massachusetts street railways..... | 55 | | | U | | Urban railways of the world..... | 136 | | |
| Mechanical traction on street railroads 30, 31, 73, 90, 117. | | | | U. S. Mail street cars..... | 145, 209, 228 | | | | |
| Meigs elevated railways..... | 52, 92 | | | V | | Van Depoele, Chas. J., Chicago..... | 136, 161 | | |
| Messier car brake..... | 235 | | | Van Depoele electric railways..... | 145, 230 | Van Depoele underground conduit..... | 155 | | |
| Metzlike Street Railway Supply Co..... | 253 | | | W | | Warming cars (New mode of)..... | 194 | | |
| Monthly calendar (Andrews')..... | 20 | | | Warming and ventilating Boston cars..... | 202 | Washington (D. C.) cable railway bill..... | 38 | | |
| Motors other than cable or electric..... | 226 | | | Weis storage battery test..... | 185 | West End street Railway Co., Boston..... | 177 | | |
| Moulton's elevated railway car trucks..... | 97 | | | Wheel which turns itself (?)..... | 116 | Whitney contracting chill..... | 235 | | |
| | | | | Woodward storage battery..... | 187 | | | | |

DIRECTORY SUPPLEMENT.

| | |
|---|---|
| Baldwin Locomotive Works..... | p. 21 (December). |
| Base hits—great game!..... | p. 19 (September). |
| Books, Periodicals, etc..... | p. 16 (October). |
| Boston street railway consolidation..... | p. 19 (August). |
| "Boston wants them, too"..... | pp. 3 and 4 (October). |
| Brussels electric railway..... | p. 21 (December). |
| Business notes..... | p. 4 (October). |
| Clay's portable register..... | p. 20 (December). |
| Horse, cable, electric and other railways..... | pp. 19 and 20 (December). |
| Official Directory of the street railways (or tramways) of the World..... | pp. 3, 5, 7, 9, etc. |
| Patents..... | p. 4 (October); pp. 18, 26 and 27 (December). |
| Rapid transit problem, (The)..... | p. 16 (November). |
| Silvester compressed air motor..... | p. 20 (December). |
| Storage batteries for street cars (views of Prof. Reckenzaun, etc.)..... | pp. 19-21 (November). |
| Street railway leaders..... | p. 26 (November). |
| Street railway traffic..... | p. 19 (November). |
| Trades' Directory (including all manufacturers and dealers in street railway supplies), pp. 15-19 (Aug. and Sept.); pp. 19-23 (Oct.); pp. 22-26 (Nov. and Decr.). | |

* * * Pointers are arranged alphabetically, as to States and cities, in the STREET RAILWAY GAZETTE; and the notes comprised therein are so convenient for reference that only the paragraphs of most general interest—such as the sale of the Chicago West Division railway, etc.—are included in these indexes.

Street Railway

GAZETTE.

VOL. I.

CHICAGO, JANUARY, 1886.

No. 1.

JAMES K. LAKE,

SUPERINTENDENT OF THE WEST DIVISION RAILWAY COMPANY, CHICAGO, ILLINOIS.

The accompanying portrait will be recognized by every member of the American Street Railway Association as that of its former vice-president and member of its executive committee, who has been for the past twenty-three years identified with the great street-railway corporation, whose workings he still superintends.

Mr. Lake's family, parents and grand-parents, were natives of Sharon, Litchfield County, Connecticut, where he himself was born, on the 22d of November, 1835; so that on the twenty-second of last November, Mr. Lake celebrated his fiftieth birthday.

Nathaniel B. Lake, the father of James, was a farmer, and in the year 1840—or about the time the junior Mr. Lake had entered his sixth year—the family removed to the town of Albion, in Orleans County, New York, where they still reside.

During the progress of the enlargement of the Erie Canal, Mr. Lake having reached early manhood, engaged with his father in the execution of various public contracts in connection with that work, after the completion of which he came to try his fortunes in the larger fields of energy then opened for youth and enterprise west of the Ohio River. The rapidly growing city of Chicago seemed to hold out the greatest inducements, and accordingly, he came hither during the spring of 1859, since which date, he has been a constant resident of the city.

Being a man of cool and keen judgment and practical ability, coupled with decision and energy, he soon found a field for his skill and talents, and almost from the day of his arrival, he became prominent in the field of public improvement. He has thus been identified from the beginning with many of the city's public works, especially in the line of street improvements. One

lasting monument to his ability and enterprise is known by and exhibited to every visitor of Chicago, in the Washington street tunnel, though few even of the inhabitants know that they owe this invaluable adjunct to Mr. Lake. The history of the enterprise is, briefly, this: In May, 1867, the former contractors having abandoned the work, the walls of the excavations on either side of the river caved in, and the work was as if it had never been begun, while

America is familiar with the magnitude and importance of the West Division Railway Co.; with its 43 miles of double tracked streets, 679 substantial, comfortable and beautiful cars, always up to the mark of the latest improvements; its many fine buildings, and excellently appointed shops and machinery; its 3,800 first-class horses, which made in 1885, a total mileage of 7,700,000 miles; and its working force of 2,000 men. James K. Lake personally superintended

the construction of the company's lines from their inception, and has continued to guard and foster the company's business ever since. Few persons out of the run of street-railway statistics have any conception of the real magnitude of this enterprise and its importance to the city of Chicago. It is the great carrying medium between the business centre of the city and its outlying wards and suburbs on the north-west, west, and southwest. Radiating from three points on State street (Madison, Randolph and Lake streets), its lines cross the river, and divide and re-divide, sending branches to every point west of the river, from Bridgeport on the south, to the lumber yards and grain depôts on the north. Intercourse between the manufacturing districts and the business centre is rendered possible through their media, and the growth of the city in the most favorable directions is encouraged and assured by their presence. And at the working centre of this vast network

of street-railways, sits Mr. Lake, cool, calm and deliberate, ready for any emergency, with a firm grasp of each minutest detail, from the inspection of a load of hay, or the treatment of a sick horse, to the laying of a new line, or the erection of a new car-house.

Personally, James K. Lake is one of those "who grow upon one with acquaintance." Much injustice has been done him—often unintentionally, and still more often ignorantly—by the press and people of Chicago, and while



the city was just \$20,000 out of pocket by the experiment. In July, of the same year, the contract was awarded to James K. Lake for \$328,500. Work was begun on July 25th, 1867, and the tunnel was formally opened on January 1st, 1869. The work was one of great difficulty, and required the introduction of special devices and appliances at nearly every step, but it was a *finished* job when completed, and promises a great permanency as the city itself.

Nearly every street-railway man in

he would not thank us for constituting ourselves defenders of one whose motives and actions are open and need no apology, we can not forbear uttering our formal protest against this injustice. Standing, as he does, the visible, active representative of his company, he is of course criticised for every action of the company, which is considered deserving of criticism. Then, he is not a man to form sudden and effusive confidential friendships; but those who have been nearest to him know that his friendship is worth having. He seems to act upon the Arabian injunction, to "beware of sudden friendships and slow enmities." He has a clear judgment, and a cool method of arriving at his decisions, which is very discomposing to some people; and being himself a man of the strictest veracity and integrity, and the most scrupulous industry, he demands the same from his subordinates and expects them from his associates. An honest man need fear nothing, and may expect much at the hands of James K. Lake, but woe to those guilty of dis-

ways in New York City, it appears that 103,354,729 passengers were transported thereupon during the twelve months ending September 30th last. These bald figures convey but little to a human mind. If stood in line, such a multitude would engirdle the earth, vast as it is, over 4,000 TIMES. The total population of these United States in 1880 would have had to ride *twice* each, to equal that number.

Many think the Elevated Railways of the above system have about reached their capacity. Their patronage is similar to that of surface street railways, in as much as the great bulk of the business is crowded into a brief space of time, morning and evening.

Thinking minds have pondered upon this subject! They turned at once to underground railways, but were met with numerous objections, chief among which was the well-nigh impossible task of affording requisite ventilation. Every passing engine, vomiting forth sulphurous fumes, would foul the air and unfit it for use in human lungs.

nel ventilation, in connection with an underground railway.

The accompanying illustrations show a cross-section of the proposed construction under Broadway, and the surface above. The plan provides for *four* tracks, two to be used exclusively for express trains, and two for way-trains. At each side, and adjoining the curb walls, are spans 4 feet 6 inches wide by 16 feet high, affording room for pipes of all kinds—water, steam, pneumatic and sewerage, together with telegraph, telephone, and electric light wires. The foundation will be of cement, two feet in depth, covered with a layer of asphalt to exclude dampness. Ample arrangements are proposed for the ingress and egress of passengers. A substantial roof of corrugated iron is proposed, covered with asphalt and cement as a foundation for the pavement. This is carried on iron posts, so that there are only the two outside walls of masonry. The following are the salient features of the plan. The excavation for the railway requires a depth of 16 feet by 35 (when finished.)

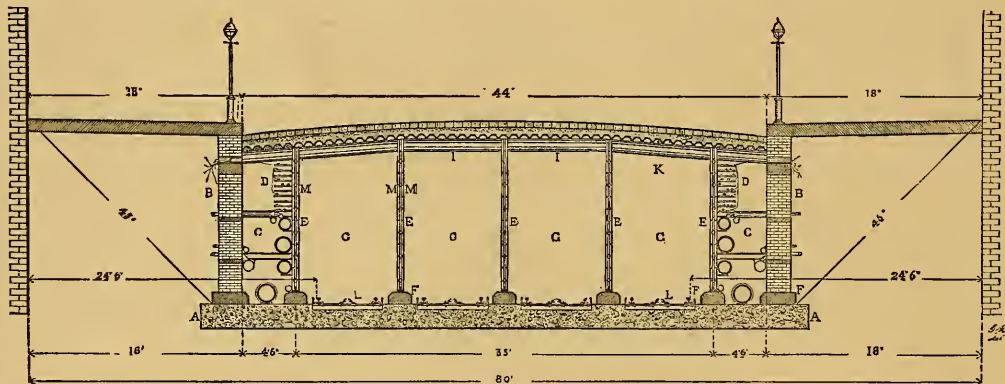

honesty, for he is as keen as a bloodhound for its detection, and unemotional as Nemesis in punishing it. A significant and striking commentary—at once a reply and a refutation—upon the detractions of his enemies (and they are generally such as have failed in trust under him) is the fact that those immediately connected with him—his own office force, and the heads of the various departments under his control—and the employes who have been longest in the service of the company, like him best, trust him most, and are his warmest defenders.

Under James K. Lake the West Division Company has become one of the model street-railway corporations of the world, and so long as he remains its superintendent, constant improvement may be safely predicted for it.

THE NEW YORK DISTRICT RAILWAY.

From the report of the Manhattan Company, operating the Second, Third, Sixth and Ninth avenue Elevated Rail-

It is the boast of this generation that, never before, within the history of the world, has humanity brought forth greater works. Upon every hand we hear of wondrous achievements. Science and mechanical skill have combined to produce the results of to-day, more wondrous than any creature of Eastern fancy, than any depicted in the Arabian Nights!

The giant strides made in harnessing that greatest of all genii, Electricity, to do the bidding of its master, man! would fill our hearts with awe and wonder, were it not that "familiarity breeds contempt." Grew states that "when the late lamented Clerk Maxwell was asked by a distinguished scientist what was the greatest scientific discovery of the last quarter of a century, his reply was, 'that the Gramme machine is reversible.'" This discovery has rendered commercially possible, the electric railway.

The originators of the New York District Railway Company purpose availing themselves of electricity as a motive power, thus solving the question of tun-

The pipe galleries 4 feet 6 inches by 16 feet on each side. The total excavation is between curb walls of the street. The trains travel upon a solid floor, not upon a bridge subject to vibration as on an elevated way. Abutting property is not affected. The nearest rail is 24½ feet removed from the building line. Vaults under the sidewalk will not be touched. The cars will be constructed of "ferflax," a non-resonant, non-breakable material, upon steel frames. It is proposed to make them spacious, luxurious, and lighted by electricity. The lines of the first section will have three southern termini, one at the Battery, one at Second avenue and Fourteenth street, and one at Ninth avenue and Fourteenth street. The two northern termini will be, one at Melrose and one at Central Park, corner of Eighth avenue and Fifty-ninth street. The New York press appears, as well it may, a unit in commending the proposed underground way, while eminent civil engineers indorse the construction, which is fully covered by letters patent in the opinion of experts in patent law.

The idea meets with the hearty good wishes of the STREET RAILWAY GAZETTE. No man's property is injured, but all is improved. The saving to the householder and to the tax-payer in permitting ready access to all street pipes, without the expense incurred in removing and replacing a pavement, is obvious to all, while the rapid transit afforded to the millions can scarcely be measured in dollars and cents. The surface railways will find their revenues increased rather than lessened, as has been the case with those affected by the construction of the elevated railroads.

We understand that the Bentley-Knight system for electrical railways will be used in operating these trains. An experimental line was operated during two years, in Cleveland, under those patents; and the Rhode Island Locomotive Works are now busily engaged in manufacturing a full working exhibit, combining the latest improvements, the result of practical, every-day experience, and it is confidently expected that early in the spring their system will be in operation in Brooklyn, Newark, Washington, Minneapolis, St. Paul, and Philadelphia. We shall await further developments with keen interest, and trust the day may not be far distant when the New York District Railway shall have become an accomplished fact.

FEMININE REVENGE

THE other day we were riding down Broadway in one of those beautiful new cars, when our attention was drawn to a dispute between the conductor and a gentle female. The lady wanted the rear door closed. The conductor, acting upon the advice of the rest of the passengers, informed her that he could not comply with her request. The conductor was a very gentlemanly young man, and evidently a new hand. He appealed to us. We told him to stand by the majority. The lady was just "biling over." We all held our breath for the *dénouement*. She couldn't stand it any longer, and, with a volume of words, she caught hold of the strap of the indicator and "rang up" five

fares on the conductor, and would probably have continued, but she broke the strap. She then strode to the door and pulled it shut, it just escaping our fingers, and demanded that the car be stopped. The conductor, unused to such scenes,—he told us he came from the rural retreats of Philadelphia—fairly

turned pale when he pulled the bell and let her off.

The motto of our western manager (Mr. Cavell) is, according to himself: "But in the way of bargains, mark ye me, I'll *Cavell* on the ninth part of a hair."—*King Henry IV, iii, 1.*

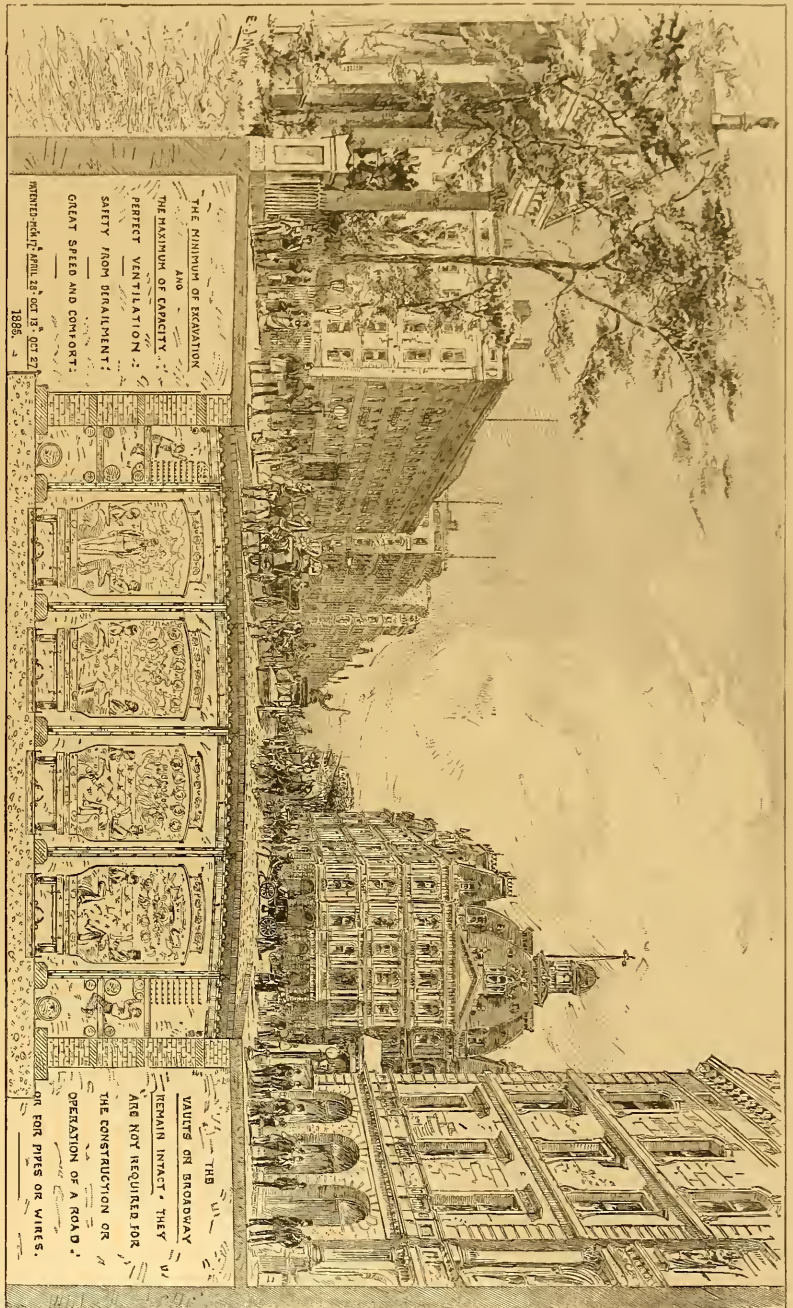

CONSTRUCTION, EQUIPMENT AND MAINTENANCE OF AMERICAN STREET RAILWAYS.

BY AUGUSTINE W. WRIGHT.

PART ONE.—TRACK CONSTRUCTION.

INTRODUCTORY.

The amount of capital invested in the street railways of this country is measured by tens of millions! Each street railroad official is endeavoring to get the *best* for the least money. The requirements for the different roads vary with the surroundings.

A track constructed in the busy streets of a great metropolis, having to carry, in addition to its own great traffic, a large portion of the general business of the city, should be built in a more substantial manner than the track in the street of a village where the traffic is proportionately less.

Few people, outside of the street railway officials, realize to what extent general traffic seeks the smooth way afforded by the rails, with lessened friction. On April 14th, 1881, I stationed a man with pencil and paper on North Clark street (in Chicago), between Elm and Division streets, for ten hours, from 7 a.m. until 12 m. and from 1 p.m. until 6 p.m., with directions to carefully count every vehicle that passed, and note those whose wheels traveled upon the horse railroad rails, those which used the sixteen feet of pavement the company has to maintain, without being on the rail, and those who traveled entirely outside the sixteen feet above mentioned. He reported 2,052 vehicles upon the rails (including 642 cars), 61 vehicles upon the aforementioned sixteen feet, but not on the rails, and 53 outside; 97.6 per cent of the street traffic at this time and place sought the street railroad, and the street was paved with pine blocks from curb to curb. On Lincoln avenue, near Webster avenue, he found 87½ per cent., and in front of Lincoln Park, 90 per cent. of the total street traffic sought the sixteen feet maintained by the street railway company.

These figures should convince the reader that street railroad tracks must not be designed and constructed to carry the street railway traffic alone. I am clearly of the opinion, also, that no dependence must be placed upon the adjoining pavements to support the tracks. Frequently, holes are dug alongside the track, the street pavement is allowed to remain long after it is worn out, and ruts are permitted to remain adjacent to the rail, caused by vehicles attempting to get onto the rail, but traveling with the wheels outside of the rail. That it is poor economy to allow the pavements to get into such a condition can not be controverted, but the fact remains, nevertheless, that only too often this is the case.

I.—THE CROSS-TIE.

Beginning at the bottom of our track, we will first consider the cross-tie. I am aware that occasionally a street railroad is constructed without cross-ties, but I question the ultimate economy. Iron ties are used to such a limited extent in this country that it is hardly worth while to discuss the substitution of iron for wood. The first point to be considered in the selection of a cross-tie is the kind of wood. The variety to be selected will depend upon the relative durability and first cost chiefly. The durability of timber buried under ground, from which air is excluded, is measured by centuries. Street railroad cross-ties are not deep enough in the ground not to be affected by the air and alternate moisture and dryness. It is difficult to obtain authentic statistics of the durability of different woods and the same kind of wood in different soils.

I extract the following from the report of the A. S. R'y Association, third annual meeting:

Mr. Clemenshaw, of Troy, stated that Georgia pine ties were apparently as good as when put in the track, after twenty-one years. Mr. Hazard stated that he used yellow pine exclusively for stringer, 5x7 inches, and chestnut or oak tie seven feet long, 6x8 inches. Used knees on both sides, and laid only centre bearing rail of fifty or sixty pounds per yard.

Wm. Wharton, Jr., considered good, heavy, substantial yellow pine stringers the best, and centre bearing steel rail fifty or sixty lbs. per yard.

Charles Hathaway considered white pine the best material for stringers, having lasted twenty years in Pittsburgh.

T. J. Minary, of Louisville, used oak, and considered its life as from ten to twenty years.

In an investigation by F. B. Hough, for the Department of Agriculture, upon the durability of steam railway cross-ties, it appears "The relative importance of the various kinds of timber for railway purposes are reported in the following order: Oaks, pines, chestnut, hemlock, cedars, tamarack, cypress, elms, ash, cherry, black walnut, firs, spruce, beech, locust, redwood, maple, butternut, coffeenut, mulberry and mosquit."

The following table gives the average durability and cost of cross-ties to steam railroads, by Mr. Hough:

TABLE OF DURABILITY AND COST OF CROSS-TIES.

| KIND OF TIMBER. | AVERAGE. | |
|--------------------|----------------------|----------|
| | Durability in Years. | Cost. |
| Oak..... | 7.4 | \$0 41.2 |
| White Oak..... | 7.3 | 40.6 |
| Post "..... | 7.0 | 33.0 |
| Burr "..... | 7.4 | 37.3 |
| Rock "..... | 7.0 | 42.0 |
| Red "..... | 5.0 | 27.0 |
| Chestnut "..... | 7.1 | 28.0 |
| Black "..... | 4.5 | 43.0 |
| Southern Pine..... | 6.5 | 37.0 |
| White "..... | 6.5 | 31.5 |
| Cedar, Red..... | 11.8 | 34.0 |
| " White..... | 7.5 | |
| Cypress..... | 8.7 | |
| Ash, White..... | 4.3 | |
| " Black..... | 3.8 | |
| Cherry..... | 6 to 10 | |

The *Railroad Gazette*, December 26th, 1884, contains a valuable editorial upon the standard dimensions and woods of American (steam railroad) cross-ties, in which it appears that the following percentage of the various woods is used upon 90,900 miles out of 121,592 miles in operation:

| | |
|-------------------------------|----------------|
| White Oak..... | 58.2 per cent. |
| Cedar..... | 10.4 " |
| Yellow Pine..... | 8.7 " |
| Northern Pine..... | 6.9 " |
| Hemlock..... | 5.9 " |
| Chestnut..... | 4.4 " |
| Fir..... | 1.7 " |
| Spruce..... | 1.6 " |
| Cypress..... | 1.0 " |
| Miscellaneous Soft Woods..... | 0.6 " |
| Miscellaneous Hard Woods..... | 0.6 " |

Total..... 100 "

The durability of the same kind of timber varies.

1st. With the age of the tree. "The life of trees, like that of man, has been commonly divided into three stages—infancy, maturity and old age. In the first the tree increases from day to day; in the second it maintains itself without sensible gain or loss; but in the third it declines. These stages vary in every species according to the soil, the aspect, the climate, or the nature of the individual plant."

2d. With the time of year in which the tree is cut. It is generally conceded that the decay of timber is caused by the fermentation of the sap. The tree should, therefore, be felled when it contains the least sap.

3d. The timber should be seasoned before it is used. Air seasoning under a roof is the best. As a rule, my stringers and ties are piled up so that the air has free circulation about them for two years or over. Water seasoning in a running stream has been recommended from the time of Evelyn and Pepys. "The natural juices of the tree are removed by the water penetrating throughout its pores."

4th. The soil in which the tree grows affects its durability. Wood grown in a moist soil is lighter and decays

sooner than that grown in dry, sandy soil. Its structure is not so compact and it contains more moisture.

The cross-tie of a street railroad has quite a different duty to perform from that of a steam railroad. In the street railroad the tie is not subjected to wear, as it is under the rail of a steam railroad. It is not so subject to decay, being protected by the pavement from the weather. It seems to support the track, and when angle irons are used, to hold the rails and stringers to gauge. I use cedar cross-ties, costing, this season, in Chicago, 27 cents each. My specifications are: Ties to be of sound cedar, sawed to eight feet in length, six inches deep, and not less than six inches face, sawed on top and bottom.

Sawed ties are considered objectionable upon many steam railroads, being thought not so durable, and they are not as strong; but in street railway tracks it is important to have a smooth, level surface on the cross-tie to take the stringer and give it a perfect bearing. I experienced so much difficulty in obtaining ties hewed true and level, that I have adopted sawed in place of hewn ties. The ties should, so far as possible, have equal widths, except that they should be wider under the stringer joint, so that the support given the track may be as uniform as possible. Unequal widths would cause unequal settlement of the track.

The greatest weight of a car and its load upon horse railroads probably never exceeds twelve tons, and this would be distributed by the stringer over three cross-ties, or, say, four tons per each tie, but this may be exceeded in cities by heavy loads of machinery, etc., seeking the lessened resistance afforded by the tram rails. If the cross-tie be eight inches broad and eight feet long, it would afford 5 1/4 square feet of bearing surface, and in the case of the above load of four tons, would have to carry 1,500 lbs. per square foot. My practice is to space my cross-ties four feet between centres. When plank is used outside of the track and along it, twelve and sixteen foot planks fit without waste, and stringers may be a multiple of four feet. I select the widest ties to put under the stringer joints.

Pine ties that had been under my tracks ten years appeared as sound and bright as the day they were put in, and I relaid track upon them. Cedar ties show no sign of decay after a like service. When the track is held to gauge with angle irons, or knees, as they are usually termed, the question of hardness of the wood in the cross-tie may be considered, as the harder the wood, the better it holds the spikes driven into it.

II.—ADHESION OF VARIOUS NAILS, SPIKES AND SCREWS IN DIFFERENT WOODS.

The importance of the above subject, and the comparative dearth of knowledge in print relating thereto, led to my making some experiments.

I used a Tee rail as a level, turning on an iron pin as a fulcrum, giving little friction.

The cedar used was a portion of a cross-tie eight inches wide, six inches deep. It had been felled about eighteen months. Fresh spikes were used for each test, as I found that the spike "held" much less when used twice, or more times.

Record of tests of force in pounds required to draw the following sized spikes out of a cedar cross-tie seasoned eighteen months. Spikes wedge pointed and driven across the grain of the wood:—

| SIZE OF SPIKE — INCHES. | Distance Drawn the Wood. | Force exerted in pounds to draw the spikes. | | | | | | | Average Force in Pounds. |
|-------------------------|--------------------------|---|------|------|------|------|------|------|--------------------------|
| | | 884 | 1159 | 766 | 766 | 805 | 766 | | |
| 1/4 x 1/2 x 5. | 4 1/4 in. | 884 | 1159 | 766 | 766 | 805 | 766 | | 857 4-6 |
| 1/4 x 1/2 x 6. | 5 in. | 785 | 854 | 923 | 805 | 766 | 766 | | 821 3-6 |
| 1/2 x 1/2 x 6. | 5 in. | 2159 | 1916 | 1379 | 2026 | 1120 | 1521 | | 1,691 5-6 |
| 3/8 x 3/8 x 5. | 4 1/4 in. | 687 | 1002 | 1556 | 1159 | 1080 | 1379 | 1379 | 1,202 5-8 |

The large amount in the second test of the 1/4 x 1/2 x 5 in. spike was caused by its being driven into a knot. Ignoring this one test for that reason, the average force required to extract that size of spike was 797 2-5 lbs.; second, 821

3-6 lbs.; third, 1,691 5-6 lbs.; fourth, 1,195 5-8 lbs. The respective resistances per square inch of spike surface driven into the wood were 137.6 lbs., 164.3 lbs., 169.18 lbs. and 188.64 lbs. The average of which is 177.4 lbs. per square inch.

Other experiments that I find in engineering literature upon this subject are as follows:

Trautwine, in his Engineers' Pocket Book, p. 383, speaking of the adhesion of spikes, says: "Professor W. R. Johnson found that a plain spike, .375 or 3/8 inches square, driven 3 3/4 inches into seasoned Jersey yellow pine or unseasoned chestnut, required about 2,000 pounds force to extract it; from seasoned white oak, about 4,000 pounds; and from well seasoned locust, 6,000 pounds.

"Recent careful experiments in Hanover, Germany, by Engineer Funk, give from 2,465 to 3,940 lbs. (mean of many experiments, about 3,000 lbs.) as the force necessary to extract a plain, one-half square inch iron spike, six inches long, wedge pointed for one inch (twice the thickness of the spike) and driven 4 1/2 inches into white or yellow pine. When driven five inches, the force required was about one-tenth part greater. Similar spikes, nine-sixteenth inches square, seven inches long, driven six inches deep, required from 3,700 to 6,745 pounds to extract them from pine, the mean of the results being 4,873 pounds. In all cases about twice as much force was required to extract them from oak. The spikes were all driven across the grain of the wood. Experience shows that when driven with the grain, spikes or nails do not hold with more than half as much force.

"Jagged spikes or twisted ones (like an auger) or those which were either swelled or diminished near the middle of their length, all proved inferior to plain, square ones. When the length of the wedge point was increased to four times the thickness of the spike, the resistance to drawing out was a trifle less. When the length of the spike is fixed, there is probably no better shape than the plain, square cross section, with a wedge point twice as long as the width of the spike.

"Boards of oak or pine nailed together by from four to sixteen tenpenny common cut nails, and then pulled apart in a direction lengthwise of the boards and across the nails, tending to break the latter in two by a shearing action, averaged about 300 to 400 lbs. per nail to separate them, as the result of many trials."

Tregold, in his "Principles of Carpentry," fifth edition, p. 189, article "Nails," says: "Nails are, in fact, pins made of iron, and the resistance they offer to being drawn is very considerable."

The following abstract of Mr. Bevan's experiments exhibits the relative adhesion of nails of various kinds when forced into dry Christiana deal, at right angles to the grain of the wood:

| KIND OF NAILS | Number to the pound, avoirdupois. | Inches long. | Inches forced into the wood. | Powers required to extract. |
|-----------------------|-----------------------------------|--------------|------------------------------|-----------------------------|
| Fine Sprigs..... | 4,560 | 0.44 | 0.4 | 2 |
| Fine Sprigs..... | 3,200 | 0.53 | 0.44 | 37 |
| Threepenny Brads..... | 613 | 1.25 | 0.50 | 58 |
| Cast Iron Nails..... | 380 | 1.00 | 0.50 | 72 |
| Sixpenny Nails..... | 73 | 2.50 | 1.00 | 187 |
| Sixpenny Nails..... | 73 | 2.50 | 1.50 | 347 |
| Sixpenny Nails..... | 73 | 2.50 | 2.00 | 550 |
| Fivepenny Nails..... | 139 | 2.00 | 1.50 | 350 |

Weight in pounds required to draw a sixpenny nail driven in one inch into the below mentioned wood. Last column the amount of force in pounds.

| | Pounds. |
|---|---------|
| Dry Christiana Deal..... | 187 |
| Dry Oak..... | 507 |
| Dry Elm..... | 377 |
| Dry Beech..... | 667 |
| Green Sycamore..... | 312 |
| Dry Christiana Deal, driven in edgways..... | 87 |
| Dry Elm, driven in edgways..... | 257 |

(Thin sixpenny nails, at 73 to the pound.)

[To be continued.]

HORSE POWER.

[The following letter has been received by Mr. Augustine W. Wright, from a well known Eastern street railway man. Mr. Wright hands us the letter, which we reproduce, omitting only the name, and gives us with it the ensuing paper, which has just appeared in the *Journal of the Associated Engineering Societies*, for December, 1885. It contains data never before published, so far as we know, and will be found valuable by any street railway man interested in the subject of motive power economy.]

NEW YORK, Dec. 10, 1885.
A. W. WRIGHT, ESQ., care of North Division Railway, Chicago, Ill.

My Dear Sir—It occurs to me that you may have determined by actual test the power exerted by a pair of horses attached to a horse car represented in pounds, viz.: given different weights, loaded and unloaded, and also the relative power exerted in starting and after the car is in motion, and possibly the comparative leverage gained by increase or reduction of wheels from the 30-inch standard, also the relative power expressed by a horse with the average use of his power, and when, as in starting, the limbs are so reflexed as to bring into exercise the greatest amount of power. If you have any data illustrating any of these questions, it would greatly oblige me to receive it; if you have not, are there not points involved worth investigation? I know of no one connected with the horse railway service that would have reached any definite conclusions on any of these points, if you have not. We speak of a horse power as representing a definite proposition, but as applied it does not appear a precise formula.

I will greatly appreciate any information you can send me, either a reference to data already published, or any that may have been the result of your own investigation. Yours truly, * * *

P. S.—The cable interests are yet in pursuit of a foothold in New York, with little prospect of realizing their hopes at present. We have also wonderful activity in suggestions for improved power for street railway traction, that. But in my judgment, there is only one available, which I hardly need say to you is *steam*, and of which I hope to give you more practical proof soon. * * *

AMOUNT OF HORSE POWER USED IN PROPELLING STREET CARS.

By AUGUSTINE W. WRIGHT.

At the present time great interest is manifested by street railway companies regarding the question of the substitution of some motive power to propel their cars other than horse flesh. The various systems—electrical, cable, compressed air, Honigman, steam dummies, etc., etc., are prominently before the public, and each for itself claims, if not perfection, certainly that it is better than any other system.

It appears to me that great ignorance exists upon the part of the inventors and street railway companies themselves, as to the amount of power required to start a street car and to maintain it in motion, under average conditions. Following is an attempt towards a solution of this problem:

We will begin with Horse Power. Watt's experiments, made with large horses of the London Brewers, gave 33,000 pounds raised one foot high in one minute as the power exerted by an average horse, and this, as you all know, is the allowance in figuring engine power. This is on the assumption that a horse can exert a force of 150 lbs. over 20 miles per diem at the rate of 220 feet per minute or 2½ miles per hour, during 8 hours. But the horse's power is very variable at different speeds. Tredgold's experiments gave 125 lbs., Smeaton 100 lbs., Hatchette 128 lbs.; all 20 miles per diem at 2½ miles per hour. Gaffey fixed the power of a strong draught horse at 143 lbs., 22 miles per diem and 2¾ miles per hour, and an ordinary horse 121 lbs. for 25 miles per diem and 2½ miles per hour.

As the speed of a horse increases, his power of draught diminishes very rapidly, until at last he can move only his own weight.

The following table shows the results obtained by different authors, those of Tredgold being for 6 hours' daily labor and those of Wood for 10 hours:

| VELOCITY. Miles per Hour. | TESTS OF DRAUGHT ACCORDING TO— | | |
|------------------------------|--------------------------------|-----------|-------|
| | Leslie. | Tredgold. | Wood. |
| 2 | 100 | 166 | 125 |
| 3 | 81 | 125 | 83 |
| 4 | 64 | 83 | 62 |
| 5 | 49 | 42 | 50 |
| 6 | 36 | | 42 |
| 7 | 25 | | 36 |
| 8 | 16 | | 31 |
| 9 | 9 | | 28 |
| 10 | 4 | | 25 |

From the above table it appears that, according to

Wood, at 4 miles per hour, a horse can draw only half his load at 2 miles; at 8 miles, only a quarter, etc.

Sir John Macneil estimates it at 60 lbs. moved 8 miles per diem at same velocity (Gillespie). "Wood's Practical Treatise on Railroads" contains an interesting chapter on horse power. He made many experiments. He quotes an interesting memorial to the House of Commons, May 3, 1830, from the proprietors of various (33) stage coaches running out of Liverpool, employing 709 horses. These horses traveled an average distance of 13 miles daily, at a speed not exceeding 10 miles per hour, and the stock had to be renewed every *three years*.

Tredgold assigned 37 lbs. as the power that a horse should exert over a distance of 10 miles in a day at a velocity of 10 miles per hour, or one horse's work. This was founded upon his experiments on stage coach horses. They endured this service only three years.

The speed of North Chicago City Railway cars is 6 miles per hour, including stoppages, and the average time of service is reckoned at five years for each horse traveling upon selected cobble stone pavement. Before the cobble stone was adopted the average railway service was four years per horse. The chief street railways of the United States estimate the railroad life of their horses at from three to five years.

I made the following tests of the force required to start car 110 of the North Chicago City Railway Co., and to keep it in motion after it was under way, using a Fairbank's Dynamometer. The track has a grade of two-tenths of a foot per hundred. (This grade is up and down, changing say each 250 lin. ft., and is compensated, as the observations were taken upon up and down grades.) The track was not free from sand. Between Chicago avenue and North avenue, on Clark street, Division street and Clybourn avenue, 88 tests, with an average of 14.8 passengers, weighing (estimated at 140 lbs.), with car, 6,772 lbs. The force required to keep the car in motion at an average speed of five miles per hour, including stops, averaged 109.5 lbs., or per ton, 32.3 lbs. This is on an old, worn out, iron rail.

Between Chicago avenue and Madison street, on Clark, on new steel rails, 53 tests, with an average of 20.9 passengers, gave 59.8 lbs. as the force required to keep the car in motion. This is an average of 15.6 lbs. per ton. The car made 17 starts on this track, with an average of 18.7 passengers. Average force exerted to start, 426.5 lbs.; average per ton, 116.5 lbs. On the first mentioned track 30 tests, with an average of 18.1 passengers, gave an average force of 487 lbs. Average per ton, 134.6 lbs.

Recapitulated, the force exerted per ton was in pounds, On good track, to start, 116.5, to keep in motion, 15.6, "bad " " " 134.6, " " " 32.3.

These tests indicate the great loss of power entailed by bad track, and also the great loss in starting; and the better the track, the greater the relative loss in starting! On the poor track 134.6 lbs. per ton was exerted to start, and this is 4.1 times the force required to keep the car in motion. On good track, 116.5 lbs. was the force required to start, but this is 7.1 times the force required to keep the car in motion!

Upon the North Chicago City Railway the average weight of car and its load is 7,740 lbs., or, in short tons, 3.87. Passengers averaged at 140 lbs. Our track is now all good. The average force, therefore, exerted in propelling our car is 3.87 × 15.6 = 60.372 lbs. when the car is in motion, and 3.87 × 116.5 = 450.855 lbs. force to start. The horses average 137.97 minutes service per diem. One hundred and three tests, upon 17 different cars, open and close, on various lines, with different drivers, made by me in different days and hours, give the following average for the horses. Time consumed in stopping, during which no power is exerted by the horse, 13.22 minutes. Time from starting until average speed is reached, 7.88 minutes.

Now, the horses average, as per above... 137.97 minutes daily service.
Deducting time they are not exerting force... 13.22 " " "
Leaves actual work... 124.75 " " "
Of this power is exerted to maintain motion 116.87 " " "
And extra power is exerted during... 7.88 " " "

The horse power, therefore, exerted in propelling a North Chicago Railway car with its average load, by a team in its average day's work, is

$$\frac{450.855 \times 311.5 \times 7.88}{33000} = 33.53 \text{ H. P. starting;}$$

$$\frac{62.472 \times 623 \times 116.87}{33000} = 133.22 \text{ H. P. maintaining motion.}$$

Total, . . . 166.75 H. P.

This is used during 137.97 minutes. Average per minute, 1.208 H. P. per tram; or for each horse, .604 H. P.

Upon a poor track, my previously quoted experiments show that this power would be about doubled, or 2.4 H. P. would be used per average car. About one-fifth of the horse power is used in starting the car (20.1 per cent.) Mr. Angus Sinclair experimented upon the Third Avenue Elevated Railroad, New York, and estimated that the average pull on the draw bar was five times greater than it would have been if the motion of the train could have been continuous. See *National Car Builder*.

A. M. Wellington found by his experiments that the initial friction in starting trains of loaded cars was 5.47 times that required to keep them in motion at a speed of 10 to 15 miles per hour. See *Trans. A. S. C. E.*, December, 1884.

Charles E. Emory, Ph.D., found 11.8 lbs. per ton of 2,000 lbs. to be the resistance on straight and level track in New York. This is less than my average, but his tests were probably made on a centre-bearing rail, the usual rail in New York, and this, we know, offers less resistance to progress, as the head is comparatively clear, while the step rail head upon which I experimented was *level with the adjoining outside pavement*, and consequently covered more or less with sand and dirt.

D. K. Clarke in his work on tramways, states that H. P. Holt found the resistance per gross ton, on straight, level track varied from 15 to 40 lbs.; Henry Hughes, 26 lbs.—often much more, occasionally less; M. Tresca, 22.4 lbs. per ton. Subsequently M. Tresca removed two flanged wheels on one side of the car, and then found the resistance 15.25 lbs. Mr. Clark assumes 20 lbs. per ton, and says at times it is 40 lbs. per ton. "An average of 30 lbs. per ton may be taken for the calculation of the ordinary tractive force." In his second volume, he states: "The average resistance—30 lbs. per ton—already in the first volume adopted for calculation, may be readopted; although an occasional maximum of 60 lbs. per ton may be reached, and on the contrary a minimum of 15 lbs. per ton when the rails are wet and clean, straight and new."

Mr. Clarke's remarks refer to grooved rails, which offer greater resistance than the step rail.

Gen. Gilmore estimates this resistance at 16 $\frac{2}{3}$ lbs. per short ton, with track in average condition, for United States.

Mr. C. B. Holmes, President and Superintendent of the Chicago City Railway, stated that his cable railway required for ordinary operation engines of 477 H. P.; of that it took 389 H. P. to move the cable and machinery; 88 H. P. (18 $\frac{1}{2}$ per cent.) was used for the propulsion of 240 cars weighing 6,000 lbs. each and carrying each 5,000 lbs. of passengers. The average speed was 9 miles per hour, or 792 feet per minute. This statement would indicate that only $\frac{389}{792} = .367$ H. P. per car was required, while my experiments would give, as 3.87 (my average load) is to 5.5 (his average load) so is 1.208 H. P. (used by me) to 1.71 H. P. required.

There must have been some mistake in his test, for .367 H. P. = 1211, foot pounds. As his speed is 792 feet per minute, the tractive force exerted would be only 15.29 lbs. for 5.5 tons—a resistance of less than 3 lbs. per ton (2.78 lbs.), which is impossible upon a step rail.

Our fellow member, D. J. Miller, M. E., while employed upon the above mentioned cable railway, made experiments upon the horse power used. He found that at an average speed of 6.85 miles per hour, or 602.8 feet per minute, 1 H. P. was required for each ton of cable and machinery and .2 of a horse power for each ton of car and its passengers. For my average load of 3.87 tons, this would equal .774 H.

P, instead of 1.2 H. P., as estimated by me. Mr. Miller's .2 H. P. = 6,600 foot pounds. His average speed being 602.8 feet per minute, his resistance to traction could have been only 10.95 lbs., including starting the cars. This is 3.94 times the resistance found by Mr. Holmes, but nearly 30 per cent. less than my experiments would indicate. Mr. Miller, however, assumed the weight of passengers, having no count of their number, and must have over estimated the load, and experimented with the track unusually clean. My average of 15.6 lbs. per ton, agreeing so nearly with those of M. Tresca, 15.25, as above quoted, confirm my opinion that it can not be far wrong. While it is true that M. Tresca's experiment quoted was with only one flanged wheel upon each axle, yet that wheel traveled in a groove, and the resistance could not vary much from my two flanged wheels not in a groove. The car wheels in Chicago are 30 inches in diameter. The horses of the North Chicago Railway weigh about 1,100 lbs. each. The speed at which they travel upon the road averages 623 feet per minute or 7.08 miles per hour. Their average horse power developed being each .604 H. P., equals 19,932 foot pounds. Divided by 623, the distance per minute, gives 31.99 lbs. tractive force. Leslie's estimate at 7 miles per hour was 25 lbs. Wood's estimate was 36 lbs. at the same speed. Our horses work daily 2 hours, 17.97 minutes, but seven days in the week, unless prevented by some unforeseen cause.

I have neglected extra resistance caused by curves, because our lines are chiefly tangents, and it is very difficult to measure the force exerted upon curves, for it varies greatly, between 400 and 1,000 lbs. upon the dynamometer with the same car and load. My tests were so unsatisfactory upon curves, that I have thought it best to omit them entirely. Then, too, the horse walks around the curve, and the lessened speed in a measure affects the increased resistance.

The greatest exertion of force upon a tangent during my dynamometer experiments occurred in starting a loaded car. It was 1,500 lbs., and per ton, 283.5 lbs. Passing through some slush, caused by snow thrown upon the track, it equaled 75.6 lbs. per ton.

In estimating for any independent motor to propel street cars upon the North Chicago Railway, I would take the maximum load and resistance. I have known of 120 passengers upon an open car. Averaging them at 140 lbs. each, equals 16,800 lbs.; car, 4,800 lbs.; total, 21,600 lbs., or 10.8 short tons; speed in starting, 0 to 623 feet per minute; average, 311.5;

$\frac{10.8 \text{ tons} \times 311.5 \text{ feet} \times 283.5 \text{ lbs.}}{33000} = 28.9 \text{ H. P. required.}$ A small portion of this power would be constantly employed, but it must be in reserve. With the electrical or cable system, no such allowance would be required, for the reason that this excess of power is only needed to start the car, and my experiments indicate that the car is starting only $\frac{1}{17}$ of the time, while it requires no power $\frac{1}{17}$ of the time. For each 17 cars upon a line, therefore, it would be necessary to furnish power to start one car and to maintain sixteen cars in motion, less the power when stationary, as it is not probable, nor is it necessary, that all should start at the same instant.

During my experiments the cars stopped upon an average, each, 1,178 lin. feet. We stop only at street intersections, or at the center of blocks more than 500 feet long.

[To be continued.]

THE PRONUNCIATION OF VETERINARY.

A dispute having arisen the other day, in our office, between two prominent street railway men as to the pronunciation of the word veterinary, it was decided that it be settled by reference to the dictionary. Authorities differing, the various usages were collated and found to be as follows: Webster, 1864, and Cull, of the same date, give vet'-er-in-ary; Worcester, 1860, and Walker, 1806, vet'-er-e-nary; Perry, 1805, either vet'-er-in-ary or veter'-inary; Knowles, 1835, vete'-in-ere; Smart, 1857, and Cooley, 1863, vet'-ere-nur-e. The first syllable is good enough for us to put an accent on.

SPRING EDGE SEATS.

Some of our most prominent street railway companies have recently adopted these seats* for their new cars, and the improvement in comfort is so marked as to merit for the invention a brief description.

The ordinary car seat is a shallow wooden box, filled with springs and upholstered. Consequently the side of the box becomes the edge of the seat, to the great discomfort of the sitter.

A reference to the accompanying cuts will show how this invention dispenses entirely with the box-frame, and provides a seat equally elastic at all points, including the edges.



Fig. 1.

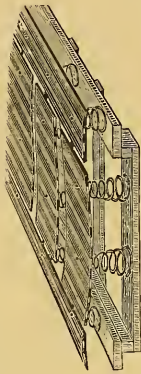

Fig. 2.

This spring is furnished as, shown in fig. 1, with frame ready for upholstering, and either with or without the first canvas. It is made any size required; the springs used are evenly distributed over the whole surface of the seat; the outside row extends entirely around, near the edge, and all of them are firmly riveted to the patent flexible slatted top and steel cross-pieces, no wire or webbing being used.

Fig. 2 illustrates the same device modified so as to form a "drop down" seat. It is in the same principle, the only difference being that the center springs are longer and drop down, making the form of the bearing surface for the upholstering, slightly concave.

*The Hale & Kilburn Mfg. Co., Philadelphia, Pa.

WINTER SHOING.

The West Division Railway Company, of Chicago, has an enviable reputation for keeping good horses, and for being very "advanced" in its methods of caring for them, especially in the important matter of shoeing. As some queries had reached us regarding this company's manner of "rough" or winter shoeing, we addressed Foreman Leg-

gett on the subject, and he has replied, as follows:

Editor Street Railway Gazette:

You wished to know if we had adopted anything new for winter shoeing, and how our system compares in practice with my experience with other systems. There is nothing new, so far as I am aware, about the system we are employing. For winter we use the Goodenough sharp shoe, of which I send you herewith a sample [from this sample we have had an engraving made, which is shown below.] You

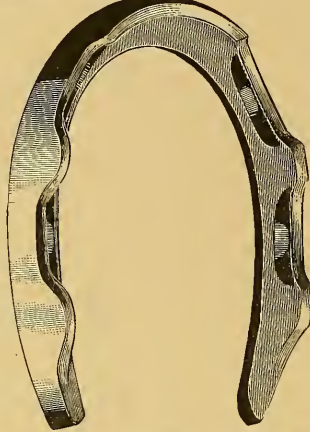

will note that it is, comparatively, a very light shoe, and that it is made of steel, forged so that the whole shoe forms, as one might say, a single calk, or a closely connected series of calks. As to the advantages possessed by this shoe over any other I have ever met with, they seem to me so obvious as to scarcely call for designation.

In the first place, you will recall that the ordinary winter shoe is a heavy metal hoop, having a high toe piece (or calk) in front, and two high heel pieces behind, so that the horse walks upon it as if his hoofs were placed—to use the Rev. J. G. Wood's apt comparison—on patens. This serves effectually to keep any portion of the foot from touching the ground, and if ice or snow could give a horse cold toes, would effectually prevent such a misfortune. The first point noticeable in the Goodenough shoe, in contrast with other patterns, is, that it is made so cupping on the ground surface, that the whole rim of the shoe forms a calk, and at the same time (and this is a most important consideration) keeps the foot so near the ground, that the frog gets full pressure, and takes the jar off the back, tendons and shoulders, as it was intended by nature to do; while at the same time, it is permitted to play its destined part in giving the required grip upon the surface on which the animal treads. You will observe further, that the horse gets an even bearing on the wall of the hoof, so that there is no undue pressure on any part of the foot, as there is when the three-calk shoe is used. Then, with this shoe, it is impossible for a horse to "calk" or "cut" himself, and he is never troubled with "shoe-boils," another difficulty common with the three-calk shoe.

But what I regard as the most important point of advantage gained with the Goodenough Winter-Shoe, is, that no fire is used in fitting it to the feet. There is nothing more pernicious

(excepting, possibly, cutting off the frog or paring the sole) than the application of heat to the walls of the hoofs. The hoof of a horse is just as highly organized as the nail of a human toe, and I think there are few who would be foolishly enough to burn down their toe nails when they wanted to get fitted with new shoes; but the damage that would be done in such a case, would be slight in comparison to the injury wrought to a horse's hoof in "hot-fitting." A man does not walk upon his toe-nails, but a horse does, and if their organization be destroyed and they be rendered brittle, how can one expect them to fulfil their natural healthy office?

Finally, I recommend the Goodenough shoe on the score of economy, not alone in first cost, but also in ease of application, for one man will shoe as many horses with them in a given time as three men can shoe with the old system, thus at once reducing the expense of shoeing more than one-half, benefitting the feet and saving horse-flesh.

This, I think, answers fully all your questions.

Yours truly,

THOMAS LEGGETT,
Foreman Horse-Shoeing Dept. W. Div. R. Co.
Chicago, Jan. 13th.

CHICAGO CITY RAILWAY CO.

ANNUAL ELECTION AND REPORT OF THE PRESIDENT.

At the annual meeting of the Chicago City Railway Company the following Directors were elected for the ensuing year: S. B. Cobb, S. W. Allerton, D. A. Jones, D. K. Pearsons, G. L. Hutchinson, E. M. Phelps and C. B. Holmes.

Mr. C. B. Holmes, president and superintendent, submitted his report, from which we take the following

When the cable system was constructed, there being no basis of actual work upon which to calculate the power required, the judgment of the best experts was secured, and in accordance therewith four engines were purchased of 250 horse-power each, the supposition being that half this power would be adequate for the work, and that the other half would be always in reserve, but experience demonstrated that when the speed of the cables was increased, requiring more power, and the draft was increased by snow-falls, the two engines were light for the work, and the growing business of the road would require in time the whole plant, leaving nothing as a reserve in case of accident. During the season two engines of 500 horse-power each have been added, with substantial gearing, and a 24-foot fly-wheel, weighing forty-five tons, was placed at the southern end of the cable machinery, so that now this important part of the system is in duplicate. One-half of the main shaft, which was originally nine inches in diameter, has been increased to eleven inches, and the two intermediate shafts increased to ten inches. The cog-wheels have all been replaced with others much stronger and made in halves, so as to be easily removed in case of necessity. Extra pillow blocks and heavy bed-plates have been added to each set of machinery, thereby increasing the strength and steadiness of the whole plant. All these changes were made without interfering with the operation of the cars.

In the early part of the year seventy large open cars were built and finished in time for the

summer's work. These were equipped with the best appliances to fit them for the cable system and render them comfortable to passengers. In the report one year ago it was stated that fifty box-cars had been built, twenty-three of which were not finished. These were completed in January and February and put immediately on the lines. The present rolling stock consists of 632 cars, besides three dummies on the Hyde Park line, twenty-two snow-plows, three large sweepers and three small sweepers. During the year 2,610,000 more passengers were carried than during the preceding year.

The last winter was the most severe ever experienced by the company, the mercury for several weeks remaining below zero and the falls of snow being frequent and very heavy. The effect was marked on the business of the company, reducing the receipts and largely increasing the expenses. The company owns eighty-nine and one-half miles of single track, one-half of which is paved with granite. The repairs of track and handling of snow cost over \$100,000.

The building and repairing of the cars and other rolling stock of the company grows in importance as the road increases. The cost for 1885 was \$64,844. An average of forty cars per week have been sent out of the shop, having received extensive or light repairs, as their condition required. One thousand one hundred and twenty-seven new wheels have been used. Upon this department also devolves the making and repairing of the grips and carrying pulleys for the cable lines. Of the former the company owns 117. These have required on the average to be refilled sixteen times during the year, or once every 22½ days, consuming 96,961 pounds of metal; 2,390 carrying sheaves have been filled, consuming 5,407 pounds of metal.

The cables and machinery have operated with great satisfaction throughout the year, with the exception of about two days on a portion of the system in February. The day following the great storm, when the mercury was 29° below zero, one of the drivers, failing to let go his hold, cut it and precipitated quite a disaster. So long as the cables and machinery could be kept in motion there was no difficulty, but when the cable was cut and stopped for a time, the intense cold congealed everything and made it difficult to start. In attempting to do so some of the lighter portions of the machinery were disabled. Since that, as before stated, those portions have been removed and all parts so thoroughly strengthened as to render a repetition improbable, if not impossible, and in addition precautions and safeguards have been adopted which render the operation as safe as is possible. The rate of speed at which the cars move and the ample accommodations furnished by the cable system have caused it to grow daily in popular favor, and nothing could be more marked than the impetus it has given to the improvement and settlement of property in the whole South Division of the city. The experience of the year has shown the cost of moving a car one mile by cable to be about one-half of what it is by horse-power.

The number of miles run by cable cars was 5,238,000, and by horse cars 2,506,000.

There is now in use a cable from Germany, made especially for this company, and one from Roebling Sons, in New Jersey. The others are from the Hazard Manufacturing Company, of

Wilkesbarre, Pa. Sixty thousand miles of service is the average life of cables in the main lines.

The splices and other work upon the ropes have been very satisfactory, and have contributed not a little to the success of the year's operations. About one-half the cable channel has been provided with one and one-third inch steam pipe for melting snow and ice.

At the beginning of the year the company owned 1,416 horses, 376 have been purchased for \$19,542.50, 393 have been sold or have died from disease or accident, making a total loss of horses of \$36,754.

The number at the close of the year was 1,399. The management desires to commend the heads of the various departments for their care and fidelity, and for the satisfactory work of their respective forces.

During the last five years the company has grappled with and carried through the most gigantic enterprise ever undertaken by any street railway corporation in the world.

It has wrought a radical revolution of its system, in substituting on its main lines twenty miles of cable road, with its 2,000 horse-power of steam engines and powerful machinery, moving cars at an average speed of nine and one-half miles per hour; it has added thirty miles of new lines and their equipments, necessary buildings and appliances; it has increased its rolling stock from 263 to 632 cars, and has doubled its number of passengers; it has reorganized its methods and its forces to meet the new conditions, and has battled to successful issue against difficulties, stubborn prejudices and opposition of the most pronounced character.

Many persons predicted the scheme would ruin the company, and some malicious ones hoped and labored for it. But the result has been a complete success for the company and its patrons, and has raised the value of property 50 per cent. over many miles of territory. After such an experience and over such an outcome, the management congratulates the shareholders that, although the new system is only four years old, and has not had time or opportunity as yet to show more than a beginning of what it can accomplish in well doing, the evidence is ample that careful men have become convinced of the merits of your venture, and recognize a brilliant future for your property.

The directors adopted the following

RESOLUTION:

Resolved, That the thanks of the stockholders in this annual meeting assembled, are hereby extended to the retiring board of directors for the efficient manner in which they have performed their duties during the year, and without wishing to underrate the service of any officer of the company, we must especially express our high appreciation of the valuable services rendered to the company by its president and superintendent.

We must especially express our approval of the admirable report read by him at this meeting.

FARE REGISTERS.

BY AUGUSTINE W. WRIGHT.

Considerable interest is being manifested by street-railway men in the register invented by J. W. Meaker, and I have received letters since the publication of what I wrote on "Conductors and the Collection of Fares." I am not an officer of that company and have nothing to do with the sale of the said register. I do think, and every street-railway official who has examined the register expresses the same opinion, that it is the

best portable register in existence to-day!

It surpasses in simplicity and accuracy, for it does not contain a wheel, clock-work or any complicated machinery to get out of order. The motion is transmitted by strong, endless chains, sliding in grooves. It is light, weighing about half as much as the Denton, a fact that will be appreciated by the conductor who carries it during the day.

As now made it shows single trip, up or down, on face, or total amount on face, or single trip on face and total on the back, which is covered by a locked plate, to be read only by the official who settles with the conductor.

The display seal, in the front of the register, prevents any examination of the interior until the paper in said seal shall have first been broken, as in the old bell punch.

This display seal is signed by an officer of the company and duly numbered. To use a spurious register, a forgery must therefore be committed, and this is an additional safeguard, for a man who would not hesitate to tamper with a register, would hesitate to commit forgery, which is a more serious crime in the eyes of the law.

The coloring or lettering of these seals can be at any time changed. The expense will be trifling, and a spurious register could thus be readily detected, on its being presented, by this means.

Several large companies are considering the question of its adoption. It certainly seems to me to possess all the requirements for a perfect portable register.

TO UTILIZE OLD STEEL RAILS.

A company is reported forming in Pittsburgh for the manufacture of nails from old steel rails under the patent of Mr. Edwin D. Wassell. The factory is to be located in or near Pittsburgh. The success of such an invention would solve at once the question of steel *versus* iron rails; a question which is bound to be settled in this or some similar way, for the steel rail is the rail of the future. However, Dr. Bailey, of Harrisburg, Pa., is somewhat skeptical regarding the Lauth process for the same purpose, and says: "The process was tried at our mill some time ago, and yielded excellent nails, but it didn't prove economical. On the contrary, the waste of labor and material was so marked that it seemed to be a worthless invention, and the product more expensive than the present method of making steel nails. We have no idea of adopting it. Everybody is experimenting with steel now, but we are not meddling with it. This process may prove feasible, but I don't think a sale has been made at the price stated." Nevertheless, the world moves, and the problem being before our inventors, is bound to find a satisfactory solution. Having no data, we are unable to express an opinion upon the value of either process.

THE
STREET RAILWAY
GAZETTE.

COPYRIGHTED, JANUARY, 1886.

MONTHLY, \$1.00 PER YEAR.

WALDEN, MONROE & CO.,
[LIMITED.]
PUBLISHERS.

GENERAL OFFICES.

NEW YORK, - - - - 29 Park Row.
Thomas Walden, Resident Partner.
Business Manager.
CHICAGO, - - - - 12 Lakeside Building.
P. G. Monroe, Resident Partner.
E. V. Cavell, Business Manager.

George B. Heckel, - - }
R. Grimshaw, - - } Editors.
Henry C. Lockwood, - - }
J. D. Nolan, - - - }

BRANCH OFFICES.

Philadelphia, Pa., 419 Walnut Street, J. Waterlyn, Manager.
St. Louis, Mo., 709 Olive St. Frank Trainor, Manager.
Atlanta, Ga., 68 Alabama St.
St. Paul, Minn., 120 East 9d St. V. R. Benham, Jr., Manager.
San Francisco, Cal., G. W. Fairchild, 320 O'Farrel St., Manager.

P. G. MONROE, formerly General Western Manager, E. V. Cavell, formerly Southern Manager, and G. B. Heckel, formerly Associate Editor of the STREET RAILWAY JOURNAL, of New York, have no further connection with that journal.

SALUTATORY.

Time-honored custom demands from the projectors of a new venture in journalism a few words of salutation and introduction, in order to secure the attention and bespeak the consideration of the proper constituency. Following this custom, we make our bow to our old friends and declare ourselves to those whom we wish to make our friends, though in the present case an introduction is of less importance than usual, for the GAZETTE can scarcely be called a venture; and its founders and staff are by no means strangers to their audience. Dispensing therefore with the ceremony of an introduction, it only remains to say that the GAZETTE is now an accomplished, though unpretentious fact, with success assured to it before the issue of the first number, and to forecast briefly its policy, so far as it has been determined.

The STREET RAILWAY GAZETTE, while devoting a liberal proportion of its space to such news as will prove of

value to street railway men and those engaged in kindred and subsidiary pursuits, will tend principally to the serious though popular discussion of practical matters in the various departments, mechanical and financial, of street railroading.

Questions of design and construction, operation and management, law and legislation, will occupy our columns.

The growth and prosperity of street railways, and affiliated interests, and the welfare of those connected therewith, will find in the GAZETTE an ardent champion, a faithful chronicler, and an earnest friend.

We do not expect success to drop into our mouths, but we mean to work for it. Our hands are, however, strengthened for the task by the great consciousness that honest endeavor will surely be crowned with honest success.

Elsewhere we rehearse, somewhat in detail, the objects which we hope to accomplish and the means which we intend to employ to that end.

OUR OBJECT.

The STREET RAILWAY GAZETTE will be not so much a scrap book of personal and news clippings—for a monthly can hardly be a "news" paper—as a record of progress in construction, management and operation of street railways. Its purpose is to foster inventions, collect and disseminate information, influence public sentiment, comment on legislation, and discuss practical every-day matters relating to the business of making money by means of street railways; to strengthen the status of street railways, give "pointers" to street railway supply dealers, and aid in rendering street-railway travel easy, frequent, cheap, and comfortable.

OUR MENU.

During the coming year we propose discussing editorially and through our contributors and correspondents, such subjects as will prove of most interest and profit to our subscribers.

In the department of permanent war, there are the questions of cobbles *versus* Belgian or wooden blocks; center-bearing *versus* side-bearing rails; the present apology for rail joints *versus* the coming joint, whatever it may be, so long as it is a joint to all intents and purposes, and at a reasonable cost; steel *versus* iron rails; stringers *versus* chairs and blocks, or cross-ties.

Touching the rolling stock:—the length of cars; means of ventilating; framing and finishing; painting and varnishing; trimming and furnishing; wheel guiding and wheel-base; springs and bearings, axles and journals, and lubrication,—afford food for reflection and themes for consideration and discussion.

The motive power:—whether it shall be four-legged or cross-headed; if the former, long-eared or short; if the latter,

whether independent, as in a dummy, or central, as in the cable system; whether electricity shall be employed, and if so, whether carried by the rails or by an overhead cable, or stored up in accumulators. These are important topics in these days of steam, steel and lightning.

In the stable and barns:—whether or not to water freely on coming in from work, what and how much feed to give, how and when to shoe, and whether "hot" or "cold;" how to cure and prevent ordinary and contagious diseases, will offer good battle field for the friendly settlement of amicable disputes. Even the delicate points of mule etiquette—as laid down in the Blue Grass district and carried out at the mouth of the great Father of Waters—will receive diplomatic adjustment and conscientious adjudication from our *arbitrator elegantiarum* in such matters.

The much mooted question as to whether the companies or their employes own and run the various street-car lines in this fair land, will get proper attention under skilled advice.

Legal points as to rights and responsibilities, duties and domain, come up from time to time, and will occupy their due and proper share of our thoughts and space.

Sanitation, now a mighty element in the street railway problem, will receive proper attention on our part.

The STREET RAILWAY GAZETTE will be a medium for the exchange of ideas relating to street railways. When we say exchange of ideas, we mean that we will exchange some of our ideas for some of yours and your neighbors' and your rivals'; not that in it your ideas will be swapped off for, or measured against, those of other readers.

Operation and management, and the collecting and turning in of fares, will be discussed, and matters veterinary will receive due attention and competent treatment.

OUR PERSONNEL.

Mr. Thomas Walden, senior partner of our new concern, is one of the best known technical journalists in the country, having spent a lifetime in the field and sanctum, and we congratulate The Street Railway interest and ourselves on this important acquisition to our forces.

P. G. Monroe, to whom is due the credit of having originated the first street-railway paper ever published, will give his entire attention to our western office, and will be pleased to see any of his old friends who may choose to call.

Mr. Robert Grimshaw's connection with the STREET RAILWAY JOURNAL as editor-in-chief, which connection has been only nominal for the past four months, terminated December 7, 1885, and we are happy to announce that Mr. Grimshaw will contribute regularly to this paper.

Messrs. G. B. Heckel and E. V. Cavell are personally known to almost every Street Railway official, east and west,

and need no introduction at our hands; while the rest of the staff have been selected on account of their peculiar fitness for the stations assigned them.

Surely, with such a crew, our ship is well manned, and we launch her into the uncertain sea of journalism with full faith for a prosperous and happy cruise.

FORTHCOMING PAPERS OF VALUE.

The STREET RAILWAY GAZETTE will contain during the coming year (and during all the years of its existence, for the matter of that,) practical and technical information of the greatest value to owners and managers of street-railway property. This matter will be, much of it, such as can be obtained from no other source, as many of our prominent contributors are expert specialists, who ordinarily charge very high figures for the information which will be furnished our subscribers at the subscription price of the GAZETTE, one dollar per year.

Among other contributions of this kind will be a series by the well-known expert and engineer, Mr. Augustine W. Wright, of Chicago, which will be ultimately published in book form. The series is entitled "CONSTRUCTION, EQUIPMENT AND MAINTENANCE OF AMERICAN STREET RAILWAYS," the first installment of which appears in this number, and which will be continued regularly during the year, or the greater part of it.

No street-railway man, or engineer, will doubt Mr. Wright's ability or the unique value of such a work from his hand; and it is notorious that there is nothing of the kind in existence applicable specially to American practice.

Mr. Wright also furnishes, in this issue, a valuable paper on "The Amount of Horse Power Used in Propelling Street Cars," which provides the heretofore unknown basis for comparison between the various forms of motive power, and gives correct data for economical calculations.

Dr. Oscar C. De Wolf, health Commissioner of Chicago, whose reputation as an authority on sanitary matters and public health is world-wide, will contribute from time to time papers bearing upon street-railway sanitation and its relations to public health.

Mr. Thomas Leggett, foreman horse-shoer Chicago North Side Railway Co., contributes an article on winter shoeing, and various other prominent authorities will supply regular pabulum for the digestion of live, practical and progressive street railway men.

TRAMWAYS AND HEALTH.

In matters sanitary the street railway is the great modern scapegoat. Does diphtheria start from the sewers and invade alike the reeking tenement-house and the "whited sepulcher" of the millionaire—it was the street railway did it with its little bag of salt. Does

vitality run low in a certain section of a crowded town, the metal rails are carrying off the subtle force of life—electric, etheric or mystic, whichever be it.

The street railway is nevertheless the poor man's convenience and the rich man's investment. GRIMSHAW.

UNIONS.

One of the strange, if not anomalous conditions of things that have been developed, is the combination that has taken place between conductors and drivers of street railways. It seems to us that this affiliation is an unnatural one. Persons holding essentially different positions in life should not join themselves together, either for defense or offense, in such close corporations, as these associations undoubtedly are. The driver is selected for his health and strength. He is also required to have at least a limited knowledge of horses; while to fill his position well, he should acquire a certain amount of special information. Very few of these drivers, however, could meet all the requirements of a first-class coachman, upon whom devolves the care and attention of fine horses as well as the management of all the affairs of a gentleman's stable, and, in addition to all which acquirements, there are added many difficult and delicate duties. The requirements of a conductor are entirely different from those of a driver. The conductor has charge of the whole car; of all matters that may ensure the safety of the passengers, the proper direction of the horses, and the control of the conduct of the driver himself. He is the responsible man. He must be a person of some education. He should not only know the streets along his route, but the whole city; in fact, he should be posted on travel in general, and, above all, have the requisite information to direct travelers to points where all details on these subjects may be obtained. He should be intelligent and well-mannered. He should feel the dignity of his position. But there is another great difference between the conductor and the driver. The conductor is the money collector of the company. He has to keep accounts and turn over all funds that come into his hands. He should be held to a strict accountability for any act of his, particularly any act of dishonesty. All financial corporations claim and exercise the right to discharge a money collector without giving publicity to the specific charge. Any other course would doubtless result in endless trouble and litigation.

It would be quite impossible to imagine two classes of men whose qualifications and duties are so different, as those essential to the conductor and the driver. By what process of reasoning does the conductor, who is in charge of so many important matters in the economy of a street railway, fly to the rescue of a driver who is accused of reckless driving, of brutal treatment of horses, or of general inefficiency? Why should a

driver rush to the assistance of a conductor who is discharged for failure to turn over money, or for neglect to make proper returns? The combinations that have been organized throughout the country are, to put it mildly, unnatural, if they are not actually indicative of evil intention. The persons engaged in forming these unions seem to believe that, because these two classes of employes control both ends of the cars, they should, for that reason alone, be so organized that a brutal and physical force may be exerted to accomplish any end whatever, even if it result in riot and revolution. LOCKWOOD.

STRIKES.

Good and cheap locomotion in cities is almost as important to the development of civilization as the operation of the trunk lines of railways that extend across this vast commonwealth. It would be next to the expression of a platitude to remark that the moral, intellectual and physical condition of a city is inestimably benefited by intramural trade and transit. The property along all avenues, where these systems operate is enhanced and improved. Even a street's moral character—and a street has a character to lose or gain like an individual—is benefited by the presence of a street railway line. These routes of travel bring the eye of the public directly to bear upon particular sections that have been given up to the occupation of the law-breaker and the debauched. It was the province of an omnibus line to reform a part of London, that had been considered as beyond redemption by the police and moral teachers. The streets that were once filled with dens and dives for the accommodation of thieves and murderers, are now re-built with stores and other structures for the use of respectable and worthy classes of citizens. The same process of amelioration has been going on under the potent influence of the introduction of the street railway in every large city in this country.

Although it could be shown that this system enters into every form of society in our thickly inhabited communities, and is absolutely necessary to the welfare and happiness of the people, still it must be admitted that the very employes to whom has been committed the practical working of this public trust, have, at times, seized the property of these lines of travel, taken possession of the thoroughfares and completely deprived the people of the uses and benefits of these franchises. To make use of violent means to suspend the work of a manufactory is reprehensible enough; but to interfere with the operations of a city railway is to incite riot and anarchy. An American citizen who is blessed with the form of free government should scorn to use force, arms and revolution, when the courts and the ballot-box are open to him. LOCKWOOD.

STREET RAILROADING.

The business of running street railways for profit is most satisfactory from many points of view. First, because the work is one of progress and building up rather than one of conservatism or of demolition. Second, because the success of a street railroad does not imply injury to, or the destruction of, any desirable existing industry. Third, because the volume and steadiness of the business depends upon the necessities or upon the easily gratified luxuries of the many, rather than on the whims of the few. Fourth, because those connected therewith become important factors in the development of the suburbs and outskirts of great cities, and in the advancement of small towns from insignificance to a position of influence. The range of street railroading, while hardly so wide as that of the universally execrated hack, is by no means limited to a small area, nor to a narrow range of climatic or political conditions. From regions where the cars have their wheels, in winter, replaced by sled runners, to districts where the open car is perennial, the jingle of the collar-bell and the sharp "ching" of the alarm register, mingle their vibrations with the oft-recurring stroke of the front-platform gong.

All classes and conditions of people meet freely together and are perforce assimilated. The street car is no longer only the poor man's carriage. In it, cabinet minister and the "cullud lady" bringing home his wash, sit for the time as equals. America, "the land of the free and the home of the brave" (as per national song, borrowed from foreign sources) is also the natal place of the street-railway idea.

The important part which street railways take in the development of suburbs and the agglomeration of the neighboring towns, should not be forgotten nor underrated. In this, they are an important factor in modern civilization; and in this, they go hand in hand with the newspaper. In fact, they daily assist the newspaper, in that they afford opportunity for reading the latter, to hundreds of thousands who would otherwise go journalless.

New ideas are continually jostling old traditions. The most primitive—almost archaic—devices, are found working side by side with the most advanced appliances for performing wonders which would have paralyzed even that not readily confused—let us perhaps add that monumental and continental liar—the late lamented Aladdin.

Let us add (standing and in silence) that the street-railway appears to be the chosen home of "a addition, division and silence." This three-headed, noiseless footed depredator is still the bane of the street-railway; the skeleton in its closet; the "brother-in-law" at its till. Only "eternal vigilance," which is the price of large collections and full returns as well as of liberty, will suffice to give the street-railway stockholders their

own. In matters political, the street-railway is alternately a pigeon to be plucked, and a power which presses opposition to the wall.

Ethical problems of magnitude have long ere this occupied the attention of the street-railroader. The rights of our dusky-hued brethren have been a (Ham) bone of contention in years gone by; while the status of him who is a little how-come-you-so, is not yet fixed. More lessons in politeness can be taught and learned and a keener insight into character gained, in a given time, in a crowded street-car, than in any other place.

GRIMSHAW.

SPRINGFIELD GROWN CRITICAL.

Only a few years ago Springfield was provided with a single street railway of the most primitive kind, equipped, if we remember, with two bob-tail cars, four horses and two boys. The cars made semi-occasional trips—about "once in a while," or "now and then." There was a single track with turnouts, at which the cars were supposed to meet and pass each other. If they failed to connect, the boy on the platform set his brake, tied up his lines, and sat on the bank by the wayside, whipping the grass with his mule-goat, awaiting the advent of the "slow-coach." Also, when he thought it about time to take up a collection, he would set his brake and go through the car gathering nickels, and when all were in, would start again on his mad career over the strap-rails.

Not infrequently the funeral procession would be varied by the hearse jumping the track; when all the mourners were expected to alight in the mud or dust, and correct its misguided tendencies. If, as generally chanced, the participants in the solemn event were deficient in the required strength, they all loafed around and "swapped yarns" about similar experiences, until the catalfalque arrived from the opposite end of the line, and added its quota of mourners to complete the job. Then all went merry as a funeral bell, after the teams had been reversed, passengers exchanged, and the processions started off on their return trips. At this rate of progress the corpse was often a long while in reaching the cemetery, frequently arriving only to find the gates locked, and business closed for the day.

Well, by and by, a company of enterprising capitalists came into Springfield, bought up the franchises, and laid four car lines, giving the city first-class, frequent, and regular service in every way and in all needed directions. But, as the business is necessarily close in a town of the size of Springfield, fare-boxes were provided to replace the conductors at first employed. However, the good citizens of Springfield had become luxurious in their tastes, and grumbled a great deal at the action of the company in removing the conductors, and when the other day an old gentleman was struck and killed by a

car while the driver was making change for a passenger, according to the dispatches, "The railway company is being criticised for taking the conductors off the cars in order to economize in expenses."

Well, well; as Yum Yum says, in the "Mikado," "Here's a how-de-do!" A very youthful inhabitant of Springfield can remember without an effort the day when a mule, a barefooted boy and hay-racks were quite adequate to the wants and tastes of the modest citizens of the state capital, and the guiding powers of that local institution were not criticised very sharply, either when the gamin-guided "bob-tail" brought a chance pedestrian to grief.

Of course, the accident which cost Mr. Labarthe his life, was a very sad and deplorable one, and possibly the driver is to blame for its occurrence; and, also, we suppose, the company will have to bear not only censure, but heavy damages as well. But the idea that the lives of citizens are imperiled simply because the street railway company's business does not warrant the employment of conductors, is preposterous. Similar accidents occur with cars fully equipped with conductors, drivers, spotters, bell punches and "democrat-catchers," and if street-railway companies should fill their cars with employes, casualties would transpire, now and then, just as they do in all circumstances where vigilance, prudence and nerve are sometimes suddenly demanded to avert them.

Not to encourage slang, but just to emphasize our meaning,—Give us a rest on this sort of gabble,—do! Or else we shall be tempted to advise our street-railway constituency to adopt the reported German method, where the engineer walks ahead to "shoo" people and things off the track, while his wife walks behind, pushing the train.

HECKEL.

ALLEGORICAL CAR DECORATION.

As is well known to the inhabitants of Chicago, Superintendent Lake and Master Car Painter Franklyn, of the Chicago West Division Railway, have been improving the internal appearance of their cars, by decorating the ceilings, panels, and clear stories with patterns in Lincrusta Walton. The variety of devices and designs displayed therein, the judicious intermingling of the sublime, the pathetic and the beautiful have been, as each new car was launched upon the line, a continued source of delight and rapture to the eye artistic—not to say æsthetic. But at last they have succeeded in "painting the lily, adding an odor to the violet and gilding refined gold," and this latest, greatest achievement demands to be recorded.

This happy creation is a clear story ceiling panel; the background is an ethereal pale blue; in the left field, seated on a limb overhanging a lake, is perched a sort of nondescript fowl, a

kind of cross between a wood-dove and a butcher-bird. Approaching him from the right, across the lake, comes a gigantic butterfly, while just rising out of the eastern water, appears old Sol himself. This judicious mixture of "Early English" and Japanese, with a happy dash of tea-chest "Chinee," may strike the ordinary, uninitiated eye as appalling, but to the artistic soul, the allegorical meaning conveyed is "immense!"

Let us interpret it: The dove portion of the fowl, signifies: Let me alone, I am peace itself. The butcher-bird portion: I can fight if I will! The silver breast, golden wings and distended crop, say: "If you don't believe I am 'well fixed,' look at me!" The bug in his mouth means: There's still meat in the house. Now, then, observe the butterfly; he is about one-third the size of the bird, fully as large as the sun, and twice as big as the water-lilies over which he flies as he approaches the bird. Note the gleaming war-paint on his body, the golden sheen of his wings and the belligerent attitude of his antennæ: Does he not symbolize that happy admixture of war and gold, which is characteristic of the Adams street line? How it will come out we can not predict. Usually, butcher-birds can "get away with" butterflies, and there is a sort of lurid light in the eye of this one which is portentous; but the bellicose aspect of the butterfly, his relative size, and the "get there, Eli!" position of his "feelers," make us doubt the result. We shall keep our eye on this panel, and when any change takes place, will, with our usual enterprise, report results.

MONROE.

A SPECIMEN ORDINANCE.

The New York City Councils have a reputation for peculiar methods in caring for the city's weal. This reputation they seem to be in no hurry to lose, if we may judge of the motives that actuated them in passing recently the resolution which provides that any person who drives a street-car must be twenty-one years of age, a citizen of the state one year, a resident of the city four months, and shall procure a license as a driver upon payment of \$1 to the mayor.

This is on a par with that other ordinance, set aside in the legislature last spring, which required every working engineer to pay a license to the police commissioner. The latter ordinance was specially remarkable for its ingenuity in devising a plan for extracting the lacteal fluid from the interior of the local cocoanut without injury to the shell or contents of the same. But the ordinance under consideration is to the other as an electric light to a penny dip. In the delicacy of invention exhibited therein for expeditiously and economically extracting sunbeams from cucumbers, we see evidences unmistakable of a superior genius. But did this unknown genius, in giving the reins to his galloping fancy, foresee the stupendous consequences of

such an ordinance? We think it hardly possible.

New York has changed much and rapidly during the past two or three centuries, so that one familiar with it in his boyhood days, when the Messrs. Knickerbocker, Van Tassel and others followed the tortuous cow-paths hither and thither, east of Wall street, would scarcely recognize the town to-day, save from the crookedness of its streets. The cows, with their clanging bells, have vanished, and the old reliable Broadway "busses," which succeeded them upon the scene, have vanished away from the sight of man, and the track-trammelled car of Jacob Sharp, provided by George Pullman, now perform their duty. But all these are trifling changes in comparison with those which must rapidly transpire should the new law prove tenable.

Let us examine in detail the provisions of this ordinance: First.—Any one who drives a street-car must be twenty-one years of age! This implies at the start that the driver shall *know* when he was born, which is requiring a great deal of knowledge to begin with, and, furthermore, it imposes barriers to the aspiring genius of Young America—or, rather, Young Ireland—which appear to our unbiassed minds eminently unjust. Because a youthful genius is debarred the right to vote, marry or hold property in his own name, is that any reason why he should be denied the privilege of smoking cigars, carrying a cane, or driving a horse-car? No; there is evidently some deep-laid scheme under this ordinance, and that it is a political scheme we make no doubt, as it was passed by a very political body. We do not wish to make an assertion that it is so, but if the fare-boxes on the "bob-tails" are turned into ballot-boxes at the next election, and the street-car tickets are printed with a list of candidates on their backs, we shall understand why the New York Common Councils require that these ambulatory electioneers shall be "free, white and twenty-one," and possessed of strength and intellect.

The second provision is that the driver of a street-car must have been a citizen of the state one year. See, how the net is drawn, fold on fold, closer and closer around an unsuspecting public. And this, then, is our boasted liberty and civil service reform! In a city which allows the foreign born "tourist" from a certain favored island to become a citizen, and cast his virgin vote "agin the government," almost before he quits the steerage of the ship that brings him across; by this city, we say, the free-born son of the soil is required to live one year in the state before he is allowed to manipulate a brake or jog a line. There is yet more to follow; mark how the plot thickens!

The third provision is that he must have been four months a resident of the city. Is this residence to include also a course of education, preliminary to en-

tering upon a secret service for which the driving of a car is but a blind,—a screen,—a "flier"? But now we are coming to the very kernel of the plot:

The fourth and final provision is that such driver "shall procure a license upon payment of \$1.00 to the mayor."

Shall procure a license, indeed,—but for what? Are our readers so innocent as to suppose that this license is to be for driving a car? Do not be credulous! Such it may appear on its face, but there is more behind it. The wolf masquerades in sheep's clothing, but is no less a wolf. And what does the dollar payment mean? Is the mayor poor, that he needs the dollars of the wealthy car-drivers? Citizens, a ghost stalks behind these dollars! Look to your city treasury, your city offices, your hearths and your houses! look, ere it will be too late to look, when the opportunity to protest is gone, and the arrogant "native American" rules the metropolitan barbecue!

These are the changes that will make New York a howling desert of Yankeeism and eliminate suffering Ireland from the very throne of her inheritance.

BUYER AND SELLER.

Our old friend *The American Machinist*, says:

"The sentiment about there being no occasion for differences between employers and employés, is pure nonsense. Honest men always have differed and always will continue to differ when they stand in the relation of buyer and seller."

"Jess so!" But when the buyer does not see fit to purchase of the seller, is there any sense or justice in throwing dynamite into the buyer's house? Does it make him more willing to buy? Or is it right for the seller to go around knocking on the head any other seller who might wish to deal with this buyer; even should seller No. 2 seek to undersell seller No. 1?

And, in this free America can not a man buy and sell as best suits himself?

Then, why should sellers combine to "boycott," beat or blow up a buyer because he wishes to purchase where and how he chooses? And have they any more right to treat in like manner other sellers who may wish to dispose of their wares in their own way?

So then, should not the laws of supply and demand govern this buying and selling of labor, as well as other commodities?"

We are afraid, Brother *Machinist*, you are "away off." You must select some other comparison. These labor agitators do not intend to be governed by the ordinary rules of buying and selling,—the law of supply and demand. Their commercial code is, "The seller shall fix his own price and terms, and the buyer must purchase from him or go without it!"

It is the law of force *versus* justice; of might *versus* law: of anarchy *versus* order, and bears no more semblance to

the acknowledged relations existing between buyer and seller, than the edicts of the king of Dahomey do to the constitution of the United States.

MONROE.

HAPPY NAHANT!

We have come across some very peculiar logic in the course of our experience, but an argument presented by a certain Nahant (Mass.) gentleman, against a proposed street railway connection with Lynn, certainly surpasses Socrates in its subtlety. His objection was simply that a street railway would encourage Sunday travel, and so tempt to the infraction of the fourth injunction of the decalogue.

While we have not the entire text of this worthy logician's deductions, we can easily see how, starting from a few accepted premises, he might have shown conclusively that the proposed street railway would be bound by an infallible series of motives and consequences to plunge the peaceful community of Nahant into a raging sea of crime, in comparison with which the "deep-voiced neighboring ocean" would be as a mere bucket of water. For have we not the legal axiom *falsus in uno, falsus in omnibus*? and have we not the very respectable authority of the theological sage who wrote, "If a man shall offend in the smallest point, it shall be as if he were guilty of the whole law?" *Ergo*: If a man breaks the fourth commandment, shall he not also have offended equally against the seventh, the ninth and all the rest?

Happy, happy Nahant! We congratulate you upon your escape (if, indeed, the question be finally settled) from a horde of evils, the very imagining of which makes us shudder. Truly, little actions, often the most trivial in themselves, sometimes lead in their train vast and far-reaching consequences. Consider the town of Nahant as it is to-day, a quaint, old-fashioned, quiet, picturesque and puritanical little town, peacefully dreaming away its second childhood beside the waves of the monotonous ocean; its rest broken by no harsher sound than the solemn roar of the recurrent billows, that seem to say to all eternity, "We live to-day, we die to-morrow;" of billows whose liveliest song is a long-metre psalm-tune; and startled by no occurrences ruder than the time-honored periodical visits of that guileless monster of the deep, the gentle and apochryphal sea-serpent; and then contemplate the change that might have destroyed this tranquillity but for the protest of one patriotic and conservative voice.

"Look now upon this picture."—The street-railway has come; the bumping car with its spavined team, goaded to sinful speed by a son of Erin, "who knows not Joseph," heralded by the dizzy voice of most unchurchly bells, and followed by a cloud of dust to blind the eyes and seduce the hearts of the unwary—this chariot of Beelzebub has run upon its

devastating path into Nahant. It becomes a very Juggernaut to the local morals; for Sunday arrives, and the light-hearted, the light-headed, the careless-minded, step aboard, and leaving law, order and the sanctity of uncushioned meeting-houses behind them, seek the unhallowed streets and the cushioned churches of Lynn. And in the evening they return,—no longer bearing in their hands the stainless lily of innocence; no longer wearing on their brows the olive crown of peace; no longer carrying in their stomachs the tender clam of tranquillity; aye, they return, but what a return! They come, reeking in crime and tainted with the guilt of the whole law of Sinai. In their mouths is the fatal weed of "papish" Cuba,—bound together by the poison leaves of Connecticut—which burneth and perisheth as the grass of the field, yea, as the cabbage leaf of Communipaw; in their hand is the slender staff from the unhallowed groves of Essex county, the sceptre of wickedness, even such as is borne by the sinful dude upon the ungodly pavements of Broadway; and in their stomachs writhes the fried oyster of wrath from the worldly oyster-beds of Mr. Butcher, even the beds of Revere Beach, where the wicked congregate.

In the homely but elegant phrase of the honored Hans Breitmann,—

"Ach! de efils dot from efils droo dis life haf ever grow!"

Again we congratulate Nahant upon its escape, and trust that its thoughtless would-be innovators have been silenced, and that the sinful scheme of a street-railway shall never be revived.

But we can not help drawing a moral from the peril so happily escaped. It is this: There was a time when New England rested safe from worldly innovation, surrounded as with triple walls of brass, by cerulean laws, which punished even the refractory cider barrel for working upon the Sabbath day; but since the repeal of those laws, cider is free to break the holy idleness of that awful 24 hours, and even the street-car might glide upon its fiendish mission to Lynn, unlet of law and unrestrained by Godly fear. Why, in the name of Nahant, were these venerable laws repealed? We pause for a reply.

Finally, lest some trifling and short-sighted caviller might suggest that a street-railway could be admitted to the franchises of Nahant, under the desired restrictions respecting the first day of the week, we take the occasion to forestall criticism by reminding our readers, one and all, that the snake's entire body can always get through a hole that will admit his head.

Verbum satis sapienti.

BROOKLYN BRIDGE.

It is most amusing to read the comments of the New York press on the failure of the "grip" on the cable road of the Brooklyn bridge. One would think that the roadbed was built

at an angle of forty-five degrees, to peruse the descriptions of the reporters, who may probably never take the trouble to give the matter personal attention. To us, the incline is almost imperceptible. Those who have seen the operations of the cable over the hills of San Francisco and Kansas City would certainly laugh to hear the Gothamites discuss the great difficulty of making the grip take hold, and having taken hold, hold on.

THE SECRETARY OF THE NAVY AS A RAILROAD MAN.

In a reported interview with a prominent gentleman of New York, the *Tribune* of that city gives some interesting gossip regarding the cable system of the city. We quote the principal points in his remarks: The New York Cable Co. was incorporated on April 21, 1884. Its projectors had laid out an extended plan for putting in the streets of this city a system of railroads free from horses and their clatter and other disagreeable things. Among the corporators were Wallace C. Andrews, Thomas F. Ryan, Rowland N. Hazard, Thomas W. Evans and Joseph J. O'Donohue. Associated with them was Lawson N. Fuller, who now has the reputation of being the father of the cables in this city. At this time the legislature was considering the general street railway bill. The Cable company opposed it, because it would open all the streets of this city to horse as well as cable roads. Still, the bill reached Governor Cleveland. Mr. Andrews labored late with the Governor the night before he signed the bill, endeavoring to show him that if it became a law it would open up every street in New York—including Fifth ave.—to railroads. Mr. Cleveland thought that the cable would, under the act, have an equal chance with any other corporation, considered the bill a good and necessary one, he said, and so signed it.

"That was on May 6, 1884. The Cable people were armed at all points; hardly was the ink of the Governor's signature dry before they incorporated the Broadway Railroad Co. and the Fifth Avenue Railroad Co. The corporators were the same in both companies. Five of them, Messrs. Andrews, Ryan, Hazard, Evans and O'Donohue, are among the corporators of the Cable company. The directors chosen for both the Broadway and the Fifth Avenue roads were Messrs. Warren, Roosevelt, Haven, Whitney, Ives, O'Donohue, Hazard, Andrews and Ryan, who chose the following officers for both companies: President, James A. Roosevelt; vice-president, Wallace C. Andrews; secretary and treasurer, Thomas F. Ryan. Mr. Andrews was already the president and Mr. Ryan the treasurer of the cable corporation. The Fifth Avenue Railroad has not been built, and the Broadway Railroad Co. has never laid a rail in Broadway, but the Broadway Surface Railroad Co. did it. You observe the

name of Mr. Wm. C. Whitney among the incorporators and directors of the Broadway and Fifth ave. project? In selecting Mr. Whitney there was one particularly strong point offered in his favor. Those who urged his name made the assertion that Mr. Whitney, through his county democracy and other relatives, could control the Board of Aldermen and that he was all-powerful in the courts and in the corporation counsel's office."

Mr. Fuller soon succeeded in getting the consent of nearly 30 per cent. of the Broadway property owners to the road.

"Mr. Whitney had been duly informed of Mr. Fuller's success; he was delighted with it. Mr. Fuller and his associates proceeded to push matters. They soon found that matters wouldn't be pushed. There was something wrong somewhere in the machinery. Mr. Fuller began to look about. He discovered that Mr. Whitney had gone quietly to work and had bought up the majority of the stock. And for some reason Mr. Whitney did not appear to be in a hurry about a cable. There appears to be a pretty good cause for this, for the next thing heard from him the cable people discovered that their partner and co-director was claiming to have a majority of the Broadway Railroad Co.'s stock, which carried the consent of the property owners in Broadway, and that he claimed this as his individual property and denied that the cable people had anything to do with it. Next Mr. Whitney was found in the company of Philadelphia schemers, among whom were 'Bill' Kemble, of 'addition, division and silence' fame, and W. L. Elkins and Weidener, of Philadelphia notoriety. And what was the new scheme? Simply to 'gobble up' everything there was in New York, roads existing and roads in contemplation, by a corporation with a capital stock of \$11,000,000."

"While this was going on, the Broadway Surface Railroad was laid in Broadway, and Mr. Whitney and his associates, in trying to euchre the cable people and ride two horses at the same time, got badly left."

NEXT!

It will be noticed that in this number of the GAZETTE, each of the editorial staff has his say upon one or more important topics; and that in addition to these editorial utterances—properly so-called—there is a great variety of matter from practical and distinguished contributors. These papers express merely the opinions of the writers, and as all men are liable to error, and even doctors may disagree, we do not arrogate to ourselves any kind of infallibility. Besides, there is usually more than one way of doing things, and every sensible man has his own reasons—to him good and sound—for his methods. Now it is only out of the diversity of theories—from a comparison of their results in practice, that we must look to determine and formulate the perfect system. But

unless our friends help us we can not hope to cover the grounds; therefore we respectfully ask frank criticism and friendly assistance; and we would say to our readers, each and all, "this means you!"

If your experience with the methods advocated in our columns differs from that obtained by us or our contributors, or if your conclusions on theoretical subjects treated herein, fail to coincide with our own deductions, kindly tell us so, and give us the facts and arguments as you know them. Nor do we or our contributors profess to know all that is to be known, or to remember to say all that might be said on any subject, so we must of necessity rely on our friends to help us out. "In a multitude of counsellors there is wisdom," and when each shall become possessed of the knowledge of all, then all shall know everything that is known. The only way to attain this great end is by exchanging ideas freely—by bartering the merchandise of ideas and experience. Therefore let us have something practical from the experience or reasoning of each reader; for in this way only can we hope to fulfill our pleasant mission of acting as the "middlemen" of street-railway theory and practice. Some have already spoken, and we now patiently await the comments of the next!

CROSSING CABLES.

The Philadelphia Traction Company, which has been making very elaborate experiments during the past four years, seems to have reached at last a satisfactory solution of the crossing problem. In the finally adopted plan the crossed cables are laid at different levels, and thus cross each other with less deflection, than in previous attempts. This does away with the heavy anchors for deflecting the cable downwards, and also obviates the expenditure of an immense amount of power for overcoming the incident friction. The grip is closed by the action of a screw-wheel on a series of compound levers; but the grip-jaw is also under control of a trigger-catch, by the springing of which the rope can be freed at once. At a proper distance on each side of crossings, suitable projections are placed on the slot-irons, so that when the trigger engages with these projections, the grip is freed and a spring opens it so that the cable clears it. As this cable is slightly raised to pass over the crossing cable, the forward motion lifts it entirely out of the grip, and a deflection in the slot carries the grip out of line. The momentum of the car carries it across the intervening space and at the proper point on the opposite side, the cable again falls into the grip-jaws, so that the grip-man has but to apply his wheel and clutch the cable, without stopping the car.

A working model in the company's office, on Walnut street between Fourth and Fifth streets, shows clearly the details of the system. It only remains to

see whether it will fulfill in actual practice the flattering promises of the model.

STREET - RAILWAY PROBLEMS.

Social, legal, and moral problems are constantly being presented to the "street railway man" to solve. The recent experience with strikers and rioters presents for solution one problem worthy the keenest analysis of the social scientist and the most profound learning and most subtle erudition of the law's great giants.

PERSONAL.

Some weeks ago quite a number of Chicago's old inhabitants, street-railway men and others, were honored with neat gilt-edged cards, bearing an invitation to the following effect:

1836. —:—: 1886.

Mr. and Mrs. Robert Heardt
request the pleasure of your company at the celebration
of their

Golden Wedding.

Wednesday, Jan. 6th, 1886; from 2—11 P. M.
780 S. Halsted Street, Chicago, Ill.

To the uninitiated this may have presented nothing specially remarkable, except that fifty years of wedded life is not allotted to many couples; but to those familiar with the facts of the case, this golden wedding was unique—it is the first ever held in Chicago (we believe) by a couple whose marriage occurred here, and whose married life was entirely passed here.

Robert Heardt is a son of Daniel B. Heardt (deceased) and Jane Heardt, who is still living with her son and daughter-in-law, at the hale old age of 97 years, last November.

Mr. Heardt is one of the oldest men in the passenger carrying business in the city of Chicago. He arrived and was married here in 1836, and immediately started an omnibus line, which he ran successfully until the advent of the West Side Railway Company, in 1863, when he sold out to that corporation, and accepted a position as stable superintendent in its employ. He is still superintendent of the South Halsted street stables, and has, therefore, remained continuously in the service of the West Division Company for twenty-two years.

There was quite a large gathering present to congratulate the old couple on the occasion of their golden wedding; many of the "Old Settlers' Association," of which Mr. Heardt is a member, many street-railway officials and employés, and numerous other friends and acquaintances. Among the rest, Hon. John Wentworth ("Long John"), twice mayor of Chicago, at various times representative and U. S. senator, and in every way prominently identified with the history of the city, took a prominent part, and in a neat speech, presented the couple with a check for \$500. Mr. Heardt is somewhat deaf, and before making the presentation Mr. Wentworth asked, "Which is your good ear, Robert?" Mr. Heardt indicated the sound

organ, and Mr. Wentworth, leaning down toward it, said, in stentorian tones: "I want to whisper that I thought the rest would bring you about all the gold you would want, and so I've brought you this!" handing him the check. Major Blodgett, on behalf of the superintendent's office of the West Division Railway Co., presented a silk purse containing \$200 in gold, and in his presentation speech made quite a happy *bon mot* by saying, "It is alleged that corporations have no souls; here is one at least which has a Heart. We have here the ace" (Mrs. H., senior), "the jack and the queen; and to-night Heart's are trumps!" On behalf of the conductors and drivers of the Halsted street line, Edward MacGuire, one of the former, presented a purse containing \$100 in gold.

Altogether, it was a most enjoyable affair, and the happy couple will not be likely soon to forget the esteem there testified for them by those who have known them best and longest.

Mr. Heartt is 70 and Mrs. Heartt 72 years old; both hale, hearty and happy-tempered, with good prospects before them of celebrating also Chicago's first "diamond wedding." Until that day—and may it find their happiness not a whit diminished by the intervening years—the STREET RAILWAY GAZETTE wishes them *bon voyage!*

WILLIAM RICHARDSON.

Whether one likes Mr. Richardson's business methods or not it can not be denied that he has accomplished wondrous changes in local street railway management. Before he entered politics, more years ago than he would probably like to acknowledge, he conducted a paper-hanging store in the city of Albany. The principal promoter of his fortunes was, unless I am greatly in error, the venerable Thurlow Weed, who rapidly discerned the indomitable energy which has carried the silver topped railroad man through many a scathing controversy. When Mr. Richardson assumed charge of the old Atlantic Avenue Railroad, something less than fifteen or twenty years ago, the whole concern was in a dangerously bad way. His improvement of the rolling stock and roadbed was followed by an almost immediate improvement in the ebbing fortunes of the corporation which has since derived large profits from the excellence of his management, supplemented by the exertions of his associate officers. The routes which he has from time to time added, connecting with the original lines of the company, have all been chosen with an intelligent recognition of the growing necessities of the community and an almost prophetic forecast of what the future has in store.—*Brooklyn Eagle.*

TOM. L. JOHNSON.

An item among our "pointers," in another column, gives particulars of the accident which befell Mr. Johnson, of

Cleveland, last month. We are happy to state that since the date of the item referred to we have had bulletins reporting great improvement in his condition, and giving every reasonable assurance of final perfect recovery.

JAMES K. LAKE.

As we go to press, it is officially announced that Mr. James K. Lake resigns his official position as Superintendent, and severs his connection with the West Division Railway Company, of Chicago.

As to Mr. Lake's future movements, we may state that, after allowing himself a period of very much needed rest, he will devote some time to his private affairs and properties, which, owing to the stress of his professional duties, he has for a while past very much neglected. After which Chicago may look for some important developments in the facilities for inter-mural traffic on the West Side, with Mr. Lake once more prominently to the fore.

DE WITT C. CREGIER.

Mr. De Witt C. Cregier, who succeeds James K. Lake as superintendent of the West Division Railway Company, is familiarly known to almost every man, woman and child in Chicago, as well as to every engineer of America. He came to Chicago from New York in August, 1853, to take the position of chief engineer of the water-works. He was then a young man of 23, newly married. He constructed the first engine used in the water-works, and all the machinery that has since been added was designed by him. He was chief engineer for twenty-six years, city engineer for three years, and has been commissioner of public works for the past four years, in which position he has had charge of all three of these departments. He has been identified with Chicago's progress and growth from a city of 50,000 inhabitants to one with a population of 700,000. Thirty-two years ago he operated the engine that lifted the first gallon of water from Lake Michigan by the water-works system, and has seen the demand and supply of the city expand from less than 500,000 gallons to a round 100,000,000 gallons per day. "Whether my work has been acceptable to the city," said Mr. Cregier to a reporter, "I leave for others to say. Wherever I may go, or whatever business I may engage in, I shall always be happy to render the city of Chicago any service in my power. I have received good offers before, but to have accepted them would have made it necessary for me to leave Chicago, and that I shall never do."

POINTERS.

ALABAMA.

Montgomery.

A contract is reported recently closed by the VanDeyoe Co. with the Capital City Railway Co., for twelve electric

motors, the line to be equipped and first train running within 60 days from Dec. 19th, ult.

* *

CALIFORNIA.

San Francisco.

Mr. Shinn retorts to the strictures of the N. Y. *Commercial Advertiser* with the appended open letter.

To the Editor of the *Commercial Advertiser*:

SIR: In your editorial articles in your issues of the 5th and 10th inst., referring to the bridge accident and the grip, you state that it is doubtful if grips can be made trustworthy.

You say, "Wheels pinching the cable do not afford a very secure hold for the drawing of heavy loads, and the conviction is becoming general that the cable system is hopelessly defective in point of mechanical accuracy and safety, as a means of car-propulsion." This statement is so far from the fact that I think it advisable that your readers should be informed that the Hallidie and Hovey grips, controlled by the National Cable Railway Co., have been in use in San Francisco from eight to twelve years, on grades of fifteen to seventeen feet in 100, or about five times the steepness of the grades on the bridge; but these grips do not consist of "wheels pinching the cable," and no where that I have ever heard of, except on the Brooklyn bridge, is any such substitute for a grip relied upon.

The grips in use in San Francisco afford a means of propulsion for two cars for each grip, and the strain on the grip upon these grades is greater than the strain upon the grip of the Brooklyn bridge upon its grades, the latter having a grip for each car. The Hovey grip has within the last year been put in operation on a road in Kansas City, on a grade of seventeen feet in 100, so that manifestly the failure of the grip on the Brooklyn bridge is not chargeable to any radical or necessary defect in the cable grip system of propulsion for cars, but is chargeable to the fatuity which led to the adoption on the bridge of an untried device, and persistence in its use during two years of frequent intervals, until it has resulted in an almost fatal disaster. The bridge trustees have had every opportunity to be informed of the facts, but for some reason they have been quietly ignored.

The company which is seeking to introduce the cable road on the surface of New York, which you characterize as "street grabbing speculators," are proposing to add to the facilities for travel, in this city, a system second only to the elevated roads, and one which, under their plan, if adopted, will save millions of dollars per year to the people of this city.

A gentleman who visited San Francisco last summer, and who is in no manner interested in cable railways or cable systems, said that a ride upon the Market street railway in San Francisco was the very poetry of transportation,

so smoothly and so rapidly were the cars carried along; and that road is on a line, the grades of which did not make the cable a necessity. It was originally a horse-road and was converted into a cable-road, because of the advantages inherent in the latter, and late advices from San Francisco indicate that it is already changing the direction of improvements in that city.

WILLIAM P. SHINN.

New York, Dec. 12, 1885.

.

DAKOTA.

Rapin City.

Dispatches from Bismark say that articles of incorporation have been filed with the secretary of the Territory for a street railway company, having a capital stock of \$100,000, the object being to construct a system of street railways in the above-named city.

.

ILLINOIS.

Chicago.

The incorporation is announced of the VanDepoele Electric Railway Motor Company, of Chicago, with a capital stock of \$500,000. Lucius Clark, Wm. A. Stiles, and John Easan are the incorporators. In a recent interview with a reporter of the *Daily News*, Mr. Stiles said: "We propose to demonstrate to the people of Chicago that an elevated railway can be so constructed as to remove most, if not all of the objections raised against elevated roads. To do this we propose to offer a slightly structure, suspended between the crossings by an iron lattice-work structure, supported at the crossings between towers surrounded by electric lights. The electricity by which the cars will be run will do away with smoke, noise and dust, and give rapid transit. When we can show the people a sample of this line, they will vote for its erection, and, of course, the franchise from the city will be forthcoming."

THE Chicago, Harlem & Batavia Railway Co. has been incorporated. Its capital stock of \$100,000 is divided into 1,000 shares, and it is authorized to construct a road from a point near or within the City of Chicago by way of Oak Park, Harlem, and Maywood to Batavia, in Kane county. The incorporators, who will be the first directors, are Andrew C. Lausten, John Grosseto, Otto Scheuneman, Frederick W. Belz, Charles Seegers, Edward G. and Frederick Hebold. The company owns the old Chicago & Western Dummy Road, recently controlled by John Buehler, who has sold his interest. It runs from Fortieth street to Waldheim. Two new engines and four cars have been ordered and will be put on as soon as possible, the present owners proposing to make the road a good one. They have the right of way to Maywood, and will extend the track to that point in the spring if the people there will build a bridge over the Desplaines. This extension would accommodate the people

living at Austin, Ridgeland, Oak Park and Harlem.—*Chicago Tribune*.

The North Chicago City Railway has accepted from the borough of Lake View an ordinance granting the right of way on Evanston, Graceland and Ashland avenues.

A movement is on foot in city councils, looking to an arrangement with the West Division Company, by which it shall abandon the Madison and Randolph streets bridges, and use the Washington street tunnel. The proposition is now in the hands of the Committee on Railroads.

In councils, on the evening of January 4th, a resolution was presented by Commissioner Van Pelt, authorizing the City Passenger Railway Company to run a line along Washington street in the city and outside of the limits. Referred. Washington street is an important link in the boulevard system of the city, and is used from Halsted street west to the city line, exclusively for light vehicles and pleasure-driving.

The Pullman Palace Car Co. furnished the cars for the new Adams and Harrison Street Line, Chicago, with a special new pattern of sectional "spring end" seats, made by Hale & Kilburn, Philadelphia. The peculiarity of this pattern is that though the seats are made in sections, there is no break in their continuity perceptible to a person sitting upon them, even though he be placed directly over the point of juncture. The advantages of such construction are obvious. The Gilbert Car Co. have also ordered furnishings of the same pattern for 25 new cars.

The Chicago West Division Railway Co. is about to construct a barn and car-house at the corner of VanBuren street and Kedzie av. The buildings will cost about \$100,000. The plans are prepared by Mr. Grantsyme in accordance with the views of James K. Lake, who, from many years' experience knows "what is what" in all that pertains to street railway matters. The buildings will be of brick, two stories in height, substantial and convenient.

The North Chicago City Railway is now building a new car-repair shop from plans by its superintendent of construction, A. W. Wright. The building is being erected at the corner of Sheffield and Fullerton avenues in Lake View. The main building is 106 feet front by 150 feet deep, with a wing 33 feet square. It will all be two stories high, and is to be completed by April 1st, 1886. This company is growing so astonishingly that its old shops are too small. Every one of its 375 cars passes through the shop at least once every twelve months.

The petition of George E. Bliss and Samuel H. Sweet to compel the Chicago West Division Railway Co. to extend its line from Douglas park to the city limits at Lawndale, in pursuance of an

order granted by the common council, and which petition was set aside by the lower court on the ground that there was a provision that the track be laid in case it could be so done and service sustained by the company without loss, which the company claimed could not be carried out, was recently set aside by the appellate court, on the same ground and for the same reason.

The West Division Railway Co. has purchased the large building at the north-east corner of Randolph and State streets, occupied by its offices for the past six years. The price paid for the building, as it stands, was \$129,000. It will be rebuilt, remodeled and elegantly fitted up for the use of the company and its officials.

The West Division Railway Co. will make many improvements and additions to its track, buildings and equipment during the present year. Among other important additions contemplated is the extension of the Van Buren street line along Western av. to Kinzie av., $1\frac{1}{2}$ miles; an extension of the Division Street line $1\frac{1}{4}$ miles, from Milwaukee av. to Humboldt Park, making a new line of $3\frac{3}{4}$ miles in length. As early in the spring as the weather will permit, track will be laid on 18th st., from Halsted to Western av., and on Leavitt st., from 18th st. to Blue Island av., making a separate line $4\frac{3}{4}$ miles long. An extension of the Lake street line is projected, from Central Park to 40th st., $\frac{3}{4}$ of a mile; and tracks will probably be laid on Centre av., from Van Buren st. south to 21st st., and along the latter street to Western av., making a line of about 4 miles in length.

These extensions will require some new stables and car houses, and additions to some already built. There will be provided a 300-stall stable and a house to accommodate 75 cars for the Division street line. The Eighteenth street line will require a stable for 350 horses and a house for 75 cars. The Van Buren street extension will be supplied with a new stable for 400 horses, and a car house to accommodate 100 cars, while to accommodate the remaining additions, the South Halsted street stables will be enlarged to accommodate 150 additional horses. All these improvements will be commenced as soon as possible in the spring, and pushed rapidly to completion.

The original grant from the Common Council, which gave to the Adams and Harrison Streets Railway Co. its franchises, permits it to extend beyond its present terminus, along Western av. and Twelfth st. to California av. This extension, we are assured, will be made early in the coming spring, affording easy access to the beautiful Douglas Park, and opening up for settlement a large portion of very desirable territory. The extension of the line westward on Harrison st. to the city limits will have a similar effect, and add hundreds of thousands of dollars to the value of

property now held at nominal prices. The extension of the track eastward on Adams st. to Michigan av., which will doubtless soon be made, would then give a continuous line from the lake front to the western boundary of the city, through a promising territory.

It is probable, also, that an extension will some day be made on Adams st. to the city limits, which would afford relief to the now crowded Madison street lines.

It is said that the new Chicago Passenger Railway Co. has in contemplation two cross-town lines—one on Center av. and one on Western av., as far south as 22d st.

The West Division Co. manages the summer car question in a manner equally ingenious and diplomatic. There are run alternately open and box cars. "Thus," as Mr. McDevitt remarked, "if a person gets drenched in a shower while riding in an open car, the fact that there is a closed car immediately in front and another immediately behind the open one will forestall possible grumbling; and, on the other hand, complaints against sweltering in a box car are forestalled by the reverse fact that it is preceded and followed by open cars." Smart men—those West Division officials.

The West Division Railway Co. is now using 3,792 horses and 689 cars on 96 miles of road, including the Noble street line, 2½ miles, opened November 1. Of the cars, 70 were built in the company's shops during the past year; and of these new cars, 35 are closed or box cars, and 35 are open or summer cars. A new snow plow has also been built and put in service. It is of an improved pattern, with extensible wings which admit its use for cleaning a space 16 feet wide.

Master car-builder McDevitt, of the West Division Co., has introduced a new system of permanent roof ventilation, which is, in our opinion, just the thing, and which gives opportunity for fine decorative effects. Between the ceiling of the clear story and the car roof is a space about two inches in depth, opening into the open air directly under the roof, which extends some distance beyond it. A space is left open in this ceiling so as to give communication with the outside air, and over this opening is put an oblong cover, but dropped so as to leave about two inches space between its upper surface and the ceiling proper. In this way the air circulates freely between the ceiling and the roof, and the foul air escapes through the openings just described. The entire ceiling is tastefully decorated with Lincolnstra Walton in various designs.

* *

INDIANA.

Indianapolis.

The City Railway Company has recently built a new transfer house, which the arriving cars enter at one end and the departing cars leave at the other,

thus facilitating the transfer and adding greatly to the comfort of passengers, especially in bad weather.

South Bend.

The electric road recently laid by the VanDepoele Company is reported running regularly on the completed branch, on which the horse service has been entirely discontinued.

* *

KANSAS.

Atchison.

The cars were all taken off the streets on January 4th, travel being rendered impossible by snow.

* *

KENTUCKY.

Louisville.

Two new street railway lines are reported under construction, and almost ready to begin operating.

A harness ring has been patented by Messrs. Quintus Cato and Charles A. Spaulding, of Estes Park, Col. It consists of a jointed bar ring, with a spring fastening for locking the ring closed, and made in such manner as to be especially adapted for use as a spreader for inside check lines, and also for keeping the lines from getting twisted.

Mr. H. H. Littell recently shipped another consignment of his scrapers to the Buffalo Street Railway, of Buffalo, N. Y.

Scoggan, Hudson & Co., report that "the refined and æsthetic habits" of the Blue Grass mule are becoming more generally appreciated, evidence to that being in the constantly increasing demand for these long-eared motors for street railway service.

* *

LOUISIANA.

New Orleans.

Mr. VanDepoele, of the VanDepoele Electric Man'fg. Co., has returned from New Orleans, and reports that the electric railway commenced running regularly and carrying passengers on the 13th ult. Regular trips are made all day, beginning at 8 a. m. and ending at 7 p. m.

* *

MICHIGAN.

Detroit.

The Woodward ave., Cass ave., and Jefferson ave. cars are now heated by small cylindrical sheet-iron stoves let into the seat at one side in the centre of the car, and protected on three sides by a metal-lined wood casing, and in front by nickel-plated bars. The stoves are made by the Michigan Stove Co. and consume about one hod of hard coal per diem.

The Merchants Store Railway Co. has been incorporated at Detroit, Mich., by W. A. Jackson, F. E. Snow, F. E. Fisher and G. H. Lathrop, incorporators, with a capital stock of \$25,000. It will manufacture store-service railways, tracks, etc.

The VanDepoele Co. reports a contract to build, equip and have running a line in that city by the 20th inst. The material was all on the ground and the motors finished at the date of this item—Dec. 19th.

* *

MINNESOTA.

Duluth.

A special from Duluth, Minn., says: For some time negotiations have been pending with Minneapolis capitalists for the purchase of the Duluth street railway and all its franchises. Yesterday Sam Hill, of Minneapolis, and Judge Thomas Wilson, of St. Paul, arrived in the city and closed the deal, paying \$100,000 for the property. The new company will be organized immediately, consisting of Sam Hill and Thomas Lowry, of Minneapolis; Judge Wilson, of St. Paul; A. S. Chase and G. G. Hartley, of Duluth. Sam Hill will be president of the company, and A. S. Chase will continue as manager. Sam Hill, the president of the new company, is one of the ablest attorneys in the states, quite wealthy, and a shrewd investor. He is the owner of a large amount of Minneapolis real estate, and is interested in different elevator companies and other Minneapolis enterprises. Thomas Lowry is the owner of the Minneapolis street railway lines and is president of the St. Paul street railway company. His judgment and ability as a street railway man are unexcelled. He will do much to make the Duluth lines equal to any. Judge Wilson is heavily interested in the St. Paul street railway system, and is the owner of the best cable car patents yet invented. One of these is to be utilized soon in a line of road up the hill, probably on Lake avenue. A. S. Chase, who will be the manager of the business, has held that position since the first establishment of the old company. His ability has been tested, and has not been found lacking. With the increased facilities which the new company will provide he will make the service here second to none. In 1886 it is proposed to lay double tracks on Superior street, thus doing away with switches. Four miles of new track will also be put down. The present line will be extended both to the east and west ends as fast as the streets are graded by the village. The Council will be asked at once to open and establish grades on certain streets where extensions are to be made. This request will no doubt be granted promptly. A building for stable, cars, repair-shops, and office is to be erected at a cost of not less than \$15,000 early in the spring. The old cars, now in use, will be taken off and thirteen new ones of the latest design will be purchased. This will make fifteen cars in all. One hundred head of horses and mules will be required to handle the business before the end of 1886. It is estimated that the expenditure of the company for improvements contemplated will amount to \$175,000.

Minneapolis.

The recent order prohibiting the use of locomotives on the streets within the city limits, forced the Minneapolis, Lyndale & Minnetonka Railway Company to replace its dummies with some less noisy motor. The VanDepoele electric system was selected, and we are informed that the new motors are now making regular trips to the satisfaction of all concerned.

* *
MISSOURI.

St. Louis.

An exchange stated that if possible the St. Louis cable street railway should be put in operation its entire length, from Sixth and Locust streets to the narrow gauge railway, by January 1st. The completion of the road will depend entirely upon the state of the weather during the remainder of the year; but it was the intention, despite the weather or anything else, to run cars from the down-town terminus to Grand avenue on the above-named date.

* *
MASSACHUSETTS.

Boston.

A special from that city, dated Dec. 12th, says:

Notice of an intention to file a petition to the General Court for incorporation as an Elevated Railway Co. has been recorded in the office of the Secretary of State. Among the leading petitioners are John W. Candler, Frederick O. Prince, M. Deminon Ross, and Bainbridge Wadleigh. The petitioners desire to be incorporated as the Boston Elevated Railroad Company. Their project is to build and operate elevated railroads on which trains shall be run by electricity. One proposed line is from Scollay Square to Harvard Square, Cambridge; others from the same or another central point to West Roxbury Park and to Brookline Town Hall, and from the foot of Summer street to Milton Town Hall. Besides these, a circuit railroad is proposed, to extend from the Boston & Lowell railroad along the shore front to the New York and New England railroad; thence by the Old Colony, Albany and Providence railroad stations to the Lowell, completing the circuit. The projectors claim to have certain advantages over any previously-devised plan in the particulars, especially of operating by electricity and not by steam, and in the model or design of their road and its running gear. Their model is that known as Riley's patent, and of the patent they are owners or lessees for this part of the country. The construction requires only a single line of posts. From post to post a single main rail is extended, which takes the weight of the train; on each side is another lighter rail. These two outer rails are also attached to the post, and are available as safety or guide rails, in which service no weight is brought to bear, but the train is kept in poise and its center of gravity is maintained

above the line of posts. The cars will be of the width usual for elevated railroads. The absence of steam is deemed an advantage in respect to there being less liability of frightening horses, constancy in motive force, and economy. It is said that the electrical railway is now beyond the experimental stage and its practical working is well understood. There will be no difficulty in producing power enough to run any train that it will be desirable to use. It is the intention to begin right off with a model track of half a mile in length in order to satisfy everybody by actual demonstration of the feasibility of the proposed plan. What line of road will first be built into the suburbs, if the charter shall be granted, has not yet been definitely determined, but the Cambridge line, or that to the West Roxbury park, would be, perhaps, the most likely to be chosen. As to running along the sidewalk, or over the middle of the street, no definite decision is made, and the several lines would probably be varied according to special exigencies in this particular. The amount of capital has not been fixed, but this will be determined somewhat by the extent of the grant made in the act of incorporation. The persons already enlisted in the enterprise are mostly Boston capitalists.

The elevated railroad projects which are to be pushed this winter in the Massachusetts Legislature are well backed, and their projectors appear to be in earnest. It is evident, too, that public sentiment in favor of a change is stronger than in previous years. The street-car blockades are pushing in all directions. It is clear that substantial relief from present discomforts can come only through some radical changes in the system of transit. Some think that the electric motor for propelling the cars on the surface railroads can, before very long, be successfully introduced, and modern contrivances which have had more or less success in distant cities have received some attention. But the popular expression is just now favorable to elevated roads. It is probable that the question will be fully debated in the committee hearings and in the houses before the charters are granted. It is an interesting fact that all the petitions thus far filed are for charters for elevated roads to run by electricity. The most extensive scheme contemplates city and suburban transit and a belt road around Boston.

North Adams.

A local exchange is authority for the following: Charles D. Haines, of the firm of Haines Bros., New York, and Glens Falls, N. Y., went to North Adams Monday from Rutland, Vt., to start and push a horse-railroad project. The firm he represents has completed and owns horse-railroads in a number of towns, including Sterling, Ill., Duluth, Minn., Glens Falls, Sandy Hill, and Fort Edward, N. Y., Winoski and Rutland, Vt. They also have five others in

course of construction. Mr. Haines goes to work in a manner peculiarly his own. Backed by an almost unlimited capital, he comes to North Adams and says: "If I can secure the right of way, I will order my steel, ties and cars at once and have them shipped here ready to begin work when the frost is out of the ground enough to permit the laying of the track. I will furnish every dollar necessary for the enterprise, and would ask none of the towns-people to form a company with me unless I was obliged to by the law. I came here to-day from Rutland, having finished and opened our road in that place Saturday night. I will build the road at a cost of perhaps \$75,000 or \$100,000, and when completed bond it for just enough to satisfy the law. I intend to build the road here from Blankinton to Adams, a distance of about nine miles. The cost per mile will be about \$10,000. I have had an agent here looking over the ground at times for the past three months, and I shall telegraph to-morrow for my brother to come on and work will begin at once. I applied by telegraph to Boston to-night for blanks to be used in asking for a charter." This is a project that has been long talked of, but the company could never be formed. The road will connect Blankinton, Greylock and Braytonville on the west and Adams, Renfrew and Howland's on the south, with the larger town of North Adams.

Springfield.

The street railway company has recently completed a new car house, built at a cost of \$20,000.

Holyoke.

The board of aldermen has before it a petition from the street railway company for authority to extend its tracks. At a recent hearing, President Chase said that the company, not having capital enough to extend its tracks at once, and fearing that outsiders might encroach on the territory, have asked for leave to extend its tracks in certain directions. It is intended to build much of the road, probably a mile or more, inside of a year, and the company will continue to push it as rapidly as the capital will allow. When asked what the route will probably be President Chase replied, "from Main through Dwight to High, down High to Appleton and up Appleton as far as the grade will allow."

Newton.

The town corporation has petitioned the legislature for a charter to lay tracks and operate a horse or electric railway.

* * *

NEW YORK.

New York City.

The Belt Line Co., of New York City, has just introduced stoves into the cars run on its tracks.

The city common councils have passed an ordinance requiring that street-car drivers shall be twenty-one

years of age, residents of the state one year and of the city four months, and that they shall procure licenses on payment of \$1 to the mayor.

A petition favoring the construction of a horse railroad through the transverse road under Central Park, opposite Eighty-sixth street, signed by several hundred property owners and residents, has been presented to the park commissioners, and a large delegation of the petitioners appeared before a special committee of the Park Board to urge their claims.

It is said that Third Ave. car drivers have asked, through a trades' union committee, that their work be shortened one trip per day, and that the Fourth and Second avenue lines are to follow suit at once. If the demands are refused, a strike is predicted.

The commission organized by the trustees of the New York and Brooklyn bridge to employ experts to make an investigation into the system of mechanical appliances in use on the bridge railroad have opened an office at 807 Welles building, 18 Broadway. Inventors and others who have perfected plans of grips or brakes or other mechanical appliances will be received there. The commission is composed of President James Howell and Engineers Thomas C. Clarke and Charles Macdonald, of the Union Bridge Co., and the board of bridge trustees.

The New York courts have decided that a railway track can be laid in Chambers street and Duane, New York, and accordingly the injunction brought by the cable company has been dissolved.

The Broadway and Seventh avenue line affairs occupied the attention of the railroad commissioners, at Albany, on Dec. 2d. Commissioner John O'Donnell offered a resolution in effect that it had been publicly charged by dissatisfied stockholders of the Broadway and Seventh Avenue Railroad Co. that certain bonds, to wit, \$3,000,000, issued by said company, have been improperly issued and used in connection with the Broadway Surface Railroad Co., and that gross irregularities and wrongs were committed in the organization and building of the latter road.

By the votes of Commissioners Rogers and Kernan the O'Donnell resolution was tabled.

The Broadway and Seventh Avenue Railway Co. has resumed the running of cars on the old route through University place, which has practically been unused since the construction last summer of the Broadway line below Fourteenth street. The lower Broadway line has become so popular that the cars are constantly overcrowded, and the idea of using the University route has been resorted to in order to relieve the pressure on the main road. The last car will leave at 7 o'clock p. m. Work is being pushed at the railway work-shops to

have the requisite number of cars for the University place line repaired and painted. In distinction to the lower Broadway cars, which are painted yellow, the groundwork of the new cars will be white and the dashboards red. The well-known letters "University Place" will be painted on the sides.

A special meeting of the board of rapid transit commissioners, appointed by Mayor Grace on the petition of residents of the annexed district, to provide additional railway facilities for that region, was held recently. The board, which was organized several years ago, is composed of Gen. Wm. F. Smith, Gen. Daniel E. Sickles, Henry P. De Graaf, president of the Bowery National Bank, Matthew Daly and Eldridge Gerry, Jr. Within the past couple of months a company has been formed by Jay Gould, with his son George as treasurer, and at a private meeting of the commission, on November 23d, the entire capital stock was subscribed for and the 10 per cent. cash paid in. Gould's chief associates in the company are supposed to be Cyrus W. Field and Russell Sage. The special meeting of the commission completed the formalities of the delivery of the charter to the company. The facts of the required 10 per cent. subscription and the numerical sufficiency of stockholders having been made manifest, the election of the prescribed nine directors took place, with the following result: C. W. Osborne, A. G. P. Segur, J. J. Slocum, John G. Wright, Samuel B. Benn, J. N. Brooks, Frederick K. Day, Robert O. Sherwood and George J. Gould. The directors elected the following officers: President, Frederick K. Day; Treasurer, George J. Gould; Secretary, Samuel B. Benn.

The injunction obtained by the New York Cable Railway Co., restraining the Chambers Street and Grand Street Ferry Railroad Co. from laying tracks on those portions of "Route No. 6" of the Cable Railway Co. which are identical with its own, has been dissolved by Justice Donohue of the supreme court. In his decision the Judge says:

More than a year since the questions now presented to this court were presented by the same plaintiffs in the action against the Second Avenue Railroad Co. As many of the questions then presented had not been before presented, and as to some the legislature seemed to intend that the general term should have original jurisdiction, this court gave, by an order then made, to the plaintiffs the opportunity to have submitted to the general term within a week or ten days of the order then made all the questions, including the one on which this motion will be disposed of. The plaintiff saw fit not to take that course, but consented to the construction of the railroad then sought to be enjoined, and thus avoided having the question passed upon. I had no doubt then and have not now on the question on which this motion will be

disposed of. The defendants have a charter and have the consent of the local authorities and the consent of the property owners, and it is clear that the route is needed, and the defendants are building the road. The plaintiffs claim that if some time in the near or far-distant future they can get the consents of both the city and property owners, they then may have the right to build this road, and may or may not, as it seems to them proper to do so, but in the meantime the public shall not have the use of a road on this route."

The Judge says that the Cable company has neither the consent of the property owners nor that of the local authorities, and it is in no way authorized to prevent the public benefit that the road will give. The questions presented in the claims of the Cable company will need full consideration by the general term before they are decided in its favor. At present it is hardly necessary to dispose of a question that may never necessarily arise. He adds:

"It seems to me as the whole case that the plaintiff stands in no way in a position authorized to interfere between the public and their rights in the matter of having the road which the defendants are constructing." Motion denied.

The Mayor has vetoed the Houston, West Street and PAVONIA FERRY, the Madison avenue and Eighty-sixth street and the St. Nicholas avenue and Cross-town bills, basing his vetoes on the ground that the companies ought to be required to pay to the city more than 3 and 5 per cent per annum on their receipts.

Brooklyn.

The Atlantic Avenue Co., Brooklyn, filed its report, in Albany, on December 15th, as follows: The Atlantic Railroad Company of Brooklyn; gross earnings from operation, \$448,681.59; net earnings from operation, \$70,053.60; gross income, \$120,909.10; net income, \$62,329.84.

The new Williamsburg and Flatbush Railroad Co. reports: Gross earnings, \$174,864.88; net earnings, \$42,829.89; gross income, \$42,647.89; net income, \$14,273.18.

Mr. Andrew Culver, in a recent interview with a representative of one of the local papers, thus explained his reasons for leasing his street railroads: "I never intended originally to remain in the horse car business. I am a lawyer by profession and I held on to the horse cars longer than I intended. I had no experience in the business before I assisted in building the Cross Town road. The Atlantic Avenue Railroad, with its extensive system, can do better by the public by the combination of the valuable franchises which I turn over and the already existing roads. I am free to say further that Mr. Richardson, with his long railroad experience, is probably able to manage the property of the Prospect Park and Coney Island Railroad more economically and satisfactorily than I could. The terms of the

lease provide for thorough harmony between the Atlantic avenue's system of horse car lines and my steam road to Coney Island, and the arrangement ought to benefit my road very considerably. I am satisfied with \$21,000 a year for the lease. It is not much, but it is 5 per cent. upon \$420,000. I might have made more money directly by waiting, but I think that indirectly I will make even more money by leasing at once."

The Atlantic Avenue Railroad Co., of Brooklyn, has purchased the Vanderbilt avenue street railroad of that city, for a price as yet unannounced, but satisfactory as well to buyer as seller. Mr. Andrew Culver, who held the controlling interest in the Vanderbilt, is disentangling himself from some of his numerous interests, while Mr. William Richardson, who constitutes the motive power of the Atlantic avenue road, is reaching out right and left for new extension.

The Vanderbilt avenue road is only one of a number of contemplated additions to the system controlled by the Atlantic Avenue Railroad Co. It ran from Fulton Ferry along Park to Vanderbilt avenues, and thence to Ninth avenue, along which it journeyed to Culver's depot. Its reports to the railroad commissioners are so involved with the report of the Prospect Park and Coney Island steam road, of which it was supposed to form a part, that its actual financial condition is difficult, if not impossible, to ascertain. It was, however, a paying road.

The charter of the Vanderbilt avenue road gives it the right to go up Park avenue to Broadway, E. D., and it is whispered that Mr. Richardson intends to have its route changed so as to run it to Grand street Ferry, using part of his Park avenue franchise and getting further rights from the common council.

It is the intention of Mr. Richardson, as expressed in a remark recently made to a friend, to provide Brooklyn with such a system of street railroads that a man can ride from any point to any point for five cents.

The Bergen Street Railroad will be extended to East New York during the coming spring, from its present termination at Albany avenue, opening up that section of the city known as Crow Hill, which in the last two years has been extensively built up, and which is desirous of having the road extended, and also the Brownsville District of East New York.

The company has purchased a large tract of land at the junction of East New York avenue and Bergen street for \$20,000, upon which it is intended to erect a fine car-house and stable.

Mayor Low has signed the Common Council resolution permitting the extension of the Vanderbilt and Park Avenue Railroad tracks from Broadway and Park avenue through several streets in the Eighteenth ward, including Central avenue to the city line.

East New York celebrated last month

with decorations, speeches and fireworks the completion of the Brooklyn Elevated Railway to that town. Among those present at the public meeting in Schiellen's Hall were General Stewart L. Woodford, President Uhlman and Superintendent Martin, of the Brooklyn Elevated Company; Assemblyman Earl, Edward Lauterbach, J. J. Vail, Stephen Peters, Seth Kumer, Albert Snedeker, A. J. Pouch, Hugo Rothchild, Albert A. Drake, Dr. Sidney Fox, and the Rev. Nelson J. Boss. C. Warren Hamilton presided. In his address of welcome he traced the history of New Lots, from the days of Montgomery Quinn's stage coaches to New York, to the present day. He praised Austin Corbin for what he had done for the place; spoke of the town's excellent situation, its fine water, advanced educational advantages, fine police force, and its general excellence as a place of residence. Mr. Lauterbach, of the Brooklyn Elevated Railway, was then introduced and spoke for about twenty minutes. He told of the troubles that his company had passed through in the eleven years while they were building that road. He predicted a similar experience for Mr. Woodford with the Kings county road. The local quartette sang, and after the speeches by Assemblyman Earl and others, the meeting dispersed, and the Board of Trade, with the guests, went to the Howard House, where a dinner was awaiting them.

Rome.

Rome City Street Railroad Co., capital stock, \$50,000, has been incorporated by C. D. Haines, Brooklyn; A. G. Haines, A. A. Morris, Jas. S. Morris, David S. Haines, Sandy Hill, N. Y.; E. T. Haines, Schenectus, N. Y.; S. D. Kendrick, Glens Falls, N. Y. Object: To build a street railway.

Ogdensburg.

Ogdensburg Street Railway Co., capital stock, \$70,000, has been incorporated by directors same as Rome City Street Railway Co. (also noted in this issue). Object: To build a street railway.

**

OHIO.

Cleveland.

CLEVELAND, Dec. 20.—Despatches received late last night stating that Tom L. Johnson was lying at the point of death in Louisville. He went hunting on Lake Washington, Miss., and was accidentally shot in the left hand by the premature discharge of a gun in the hands of his niece, who was hunting with him. Johnson is a millionaire street railway magnate, and owes his wealth to his fighting qualities. Cleveland owes its present excellent street-railway system to him.

About five years ago Cleveland had the poorest street railroads in America. Johnson, who is a son-in-law of ex-Governor English, of Indiana, came to Cleveland and purchased a wretched line known as the Brooklyn road, run-

ning to a suburb of Cleveland. He applied to the city for the right to run his cars into the heart of the city over the rich but poorly managed West Side Street Railway. A bitter fight, often resulting in personal encounters, resulted in a victory for Johnson. Then the West Side road, spurred on by opposition, put on splendid cars and ran them fast enough to compete with Johnson. He paved whole streets in order to get the right to extend his line, and built it from the easterly limits of the city to Brooklyn. He carried passengers ten miles for one fare, and the Woodland avenue and West Side railroads were forced to consolidate to meet his opposition. In the fierce rivalry that ensued Johnson resorted to many means to build up business. He constructed a mammoth snow-plow and drew it over his lines with ten spans of prancing white steeds whenever snow obstructed the road. The public fell in love with him, and his cars were crowded. He purchased a base ball park on his line and had clubs play there in order to make street-car travel. Sullivan, the prize fighter was hired to pitch one game in Johnson's park. He has acquired two street railways in Cleveland, and is about to purchase another. He also owns a line in Indianapolis. He is only thirty-five years of age.—*New York Sun.*

**

PENNSYLVANIA.

Philadelphia.

Hale & Kilburn, Philadelphia, Pa., report a steady increase in the demand for fine upholstery for street cars. The Pullman Company has been among the foremost in fostering this demand. To this company Hale & Kilburn furnished one hundred cars with their new patent spring-edge seats and all spring backs, for the new Broadway (N. Y.) road. They also furnished the seats for the exhibition car of the Pullman Company, which attracted so much attention at New Orleans last winter.

Argument was recently heard by Judges Hare and Mitchell, in this city upon the application of the Lombard and South streets Passenger Railway Company for a mandamus requiring the Board of Surveyors to approve its plans for the extension of its track on Front street from Dock to Market. Mayor Sulzberger claimed on behalf of the company that while the board had the right to regulate the lines, grades and details of the track-laying, it could not deprive the company of its chartered franchise to lay the track by refusing to act, and that such action should precede and not follow that of councils. Assistant City Collector McMichael quoted the ordinance of February, 1860, making it unlawful for any corporation to remove any of the cobble pavements of the highways of the city without first procuring a permit from the Highway Department, and the seventeenth article of the Constitution, providing that no street passenger railway shall be constructed within the

limits of any city without the consent of its local authorities. The court reserved its decision.

* *
RHODE ISLAND.

Providence.

Thurston, Stearns & Co., have in hand the manufacture of a cleverly designed piece of mechanism, patented by E. S. Thurber, of that city, a practical and experienced blacksmith. The ingenious contrivance is designed for the proper and correct fitting of horseshoes while cold. No fire is used at all in the operation, and the shoe can be bent in a

moment to any required size or shape. Its value to horseshoers can be seen at a glance. The same gentleman has also designed a patent punch by means of which the nail holes in manufactured horse-shoes can be punched out clearly and distinctly without leaving any burr. Both are useful inventions, and needed in their special line.

* *

VERMONT.

Burlington.

The Burlington (Vt.) horse-car directors are advertising the noble exam-

ple of one verdant youth who rode back and forth over the novel horse-railway, four miles long, 22 times on Thanksgiving day.

Rutland.

The new street-railway is well patronized and the cars are crowded by people, most of whom take a ride to see how it seems. The track is being improved and derailments are becoming fewer. About half a mile still remains unladen on the West Rutland line, and work for the winter stopped on account of the frozen ground.

CHAS. H. MITCHELL,

Attorney and Counsellor at Law.

Practices in all the Courts. RAILWAY LITIGATION A SPECIALTY. Special attention to Patent Cases and Collections. Prompt attention to Correspondence outside the city. Refers by permission to the ENGINEER'S Company, Walden, Monroe & Co., and others.

79 Dearborn Street,
CHICAGO. - ILLINOIS.

C. A. PALTZER & CO.,
LUMBER

2598 Archer Avenue, CHICAGO.

Ash, Oak and other Hardwoods suitable for Car and Track Work.

WRITE FOR ESTIMATES.

Chicago Malleable Iron Co.,

MANUFACTURER OF REFINED

Malleable Iron Castings,

Western Avenue & 26th Street,

CHICAGO.

Street Railway Work to Pattern.

Barnum & Richardson Manf'g. Co.,

64 South Jefferson Street, CHICAGO.

CHILLED STREET CAR WHEELS

FROM PURE SALISBURY IRON.

Curves, Frogs, Switches, Crossings, Etc.

To Any Pattern.

Light and Heavy CASTINGS for all purposes.

W. H. BARNUM, ALBERT ALLING, WM. E. BEST,
Pres., Lime Rock, Conn. Gen. Mgr. & Treas., Chicago. Sec'y, Chicago.

EATON & PRINCE,

MANUFACTURERS OF

ELEVATORS

—FOR—

Passengers AND Freight.

ALSO,

SPECIAL ELEVATORS

For STREET CAR BARNES.

74 & 76 Michigan St., CHICAGO.

THE

L. L. Brown Paper Co.,

Have for thirty-five years made a specialty

OF

LINEN LEDGERS.

Their make of Papers are to-day recognized as THE STANDARD for strength of Fibre, erasing and re-writing qualities.

Stationers and Blank-Book Makers

Everywhere will furnish this brand.

EACH SHEET is water-marked with trade mark of name and date.

MILLS AT

ADAMS, - MASS.

THE

Street Railway

GAZETTE.

VOL. I.

CHICAGO

FEBRUARY, 1886.

NEW YORK

No. 2.

JULIUS S. WALSH.

PRESIDENT OF THE AMERICAN STREET RAILWAY ASSOCIATION.

Julius S. Walsh is a son of the late Edward Walsh and his wife Isabella de Mun, and was born at St. Louis, Mo., on the 1st of December, 1842. The senior Mr. Walsh was a native of Ireland, and came to America in 1815, where he first settled in Louisville, Ky., and after a few years (1824) removed to St. Louis, where he immediately established the firm of J. & E. Walsh.

The junior Walsh, the subject of our sketch, was destined by his parents for the legal profession, and received in accordance with this intention an unusually liberal education. He received his elementary instruction in the private preparatory schools of his native city, and in 1856 entered the St. Louis university, where he remained three years. From here he went to St. Joseph's College at Bardstown, Ky., from which institution he graduated in 1861, and in 1863 received his degree of "Master of Arts." In the following year Columbia College, N. Y., conferred upon him the degree of LL. B., and during the same year he was admitted to the bar of the state of New York.

A short experience with the law satisfied him, and in 1864, he abandoned the profession to enter the office of his father, whose failing health demanded the constant presence of his son, and the death of the father, two years later, left the management of the entire business to Julius, who was occupied during the next four years in settling up the estate; and during this period he became a director in several important corporations.

In 1870, Mr. Walsh relinquished his mercantile interests and turned his attention to street railroading; being elected during the same year president of the Citizen's Railway Co., and of the Fair Grounds and Suburban Ry. Co. (St. Louis), since consolidated.

As years passed, Mr. Walsh's reputa-

tion as a successful railway manager gradually extended, and in 1880 he accepted the presidency of the People's Railway Co., the Park Avenue Railroad Co., and the Tower Grove & Lafayette Railroad Co. Later however,—1884— he disposed of his interests in these latter roads in order that he might devote more time to his own personal project,—the Northern Central Railroad Co., which will be opened about March 1st, prox. Besides his street railway interest,

which was occupied for only about one week out of the entire year, during the annual fair; but under Mr. Walsh's management the grounds were transformed into a point of attraction for all seasons, and were made profitable during the entire year. First he caused the Art Gallery to be erected there; then founded the Zoölogical Gardens, which have become extremely popular; and during the term of his office, all the beautiful buildings of the Department of Natural

History were erected. By these improvements and the aid of tasteful landscape gardening, the former bleak wastes of the Fair Grounds were transformed into a beautiful park, crowded with suitable lucrative attractions.

In 1875, the Illinois and St. Louis Bridge went into the hands of receivers and Mr. Walsh was appointed their agent. At that time the affairs of the company were in a very precarious condition, but under Mr. Walsh's able management, they were vastly improved. However, the property was sold, under foreclosure, and bought in by the bondholders, in 1878, and after its reorganization under the names of the St. Louis Bridge Co. and the Tunnel Railroad of St. Louis, Mr. Walsh was elected president of the reorganized companies, and has continued in that office ever since.

In 1875, he was chosen president of the South Jetty Co., but after three years, on account of the pressure of other more important business, tendered his resignation. He was also for a number of years a director of the St. Louis, Kansas City & Northern Railroad Co., eventually absorbed in the Wabash, becoming one of the tentacles of that railway octopus, of which also Mr. Walsh became a director. This position he resigned on assuming office in the Bridge and Tunnel Co.

In 1870 he was married to Miss Josephine Dickson, of St. Louis.

Mr. Walsh is regarded by his fellow citizens as a man of keen business dis-



JULIUS S. WALSH,
ST. LOUIS, MO.

(Pres. American Street Railway Association.)

Mr. Walsh has been for years one of the most popular and public spirited of St. Louis' business men, and has been or is prominently associated with nearly every public enterprise of the city. Among other positions of this sort which he has held, the following may be mentioned:

In 1874, he was elected president of the St. Louis Agricultural Association, which position he held for upward of four years. Before that date the Association held about 80 acres of land,

crimination, and his connection with any enterprise is generally looked upon as a guarantee of its solidity. He is an enemy to wild-cat schemes and stock jobbing speculations, and his name is sufficient to give steadiness and character to any project. He is a cultured gentleman, a rare entertainer, and a genial companion.

About three years ago the American Street Railway Association was organized, in Boston, and Mr. Walsh was elected a member of the first Executive Committee, and at the fourth annual convention held in St. Louis, last October, he was chosen president of the organization.

Mr. Walsh has under his direct control about 32 miles of Street Railway, being now president of three distinct companies.

(Mr. Walsh's autograph, received too late for publication in this issue, will appear in our March number.)

TOM. L. JOHNSON.

(Correction.)

ED. STREET RAILWAY GAZETTE:—In an extract taken from the New York *Sun*, anent Mr. Tom L. Johnson, which appeared in our initial number, it said that he was the "son-in-law of Governor English." This is a mistake: Mr. Johnson is in no way related to the party in question, but merely purchased the Citizens' Street Railway of Indianapolis, from him, in 1873, when it was in a very dilapidated condition; and, by careful and judicious management, he has made it one of the best and most profitable surface lines in the country.

E. V. CAVELL.

WHY WE LOST AN ADVERTISE- MENT.

We have been offered an advertisement which, on grounds of policy, we were forced to decline. Not that we should have objected to accepting and publishing the card and afterwards collecting our pay for the same. Nothing would have given us greater pleasure than to do all three of these things. But the advertisement carried with it a "tail," in the shape of a condition, and this "tail" did actually "wag the dog." The condition was that we should print among the reading matter in our columns a "puff"—unprofessionally apologized for in the above mentioned condition as a "notice"—beginning with a preamble which set forth in touching language the hunger and thirst of the world during the past ages, for a device precisely like that of Mr. So-and-so (advertised in another column), and ending with a prediction that science and art should be speedily revolutionized by its introduction.

To the advertisement we naturally answered "Thank you, yes," in tones most courteous; but as we reserve waste-basket privileges over all matter submitted for our editorial columns, we

answered to the modest notice, "Declined, with thanks." Our would-be advertiser's rule of conduct for such cases proved to be, "No puff, no ad." Hence we lost his patronage. But if from this example we can draw a profitable lesson, we shall not repent the misfortune, for it gives us the opportunity to say that we do not intend to use our editorial columns for advertising purposes, except in so far as information and criticism, full, candid and sincere, necessarily include advertisement of the subject under consideration. We are convinced that the street railways of this country are liberal and intelligent enough to support a journal which shall be something more than a mere trade catalogue; had we not believed this, we should never have started the GAZETTE, for we have been convinced by experience that any other basis of journalism must prove abortive.

Therefore, the reading columns of this paper will be filled with the best matter we can write, borrow or buy, and we will seek to supply to our readers such information only as shall be useful to them in their various capacities as street railway men. In fact, our aim is to make the GAZETTE indispensable to the progressive "street railroader," and by doing so, we shall also gain for our advertising pages a value that could be obtained by no system of puffery, cataloguing, "noticing," or other method of sugar-coating advertisements, however specious and seductive.

HECKEL.

THE HORSE CAR STOVE.

Stoves in the horse cars are not new institutions, but the latest form of heating apparatus is novel, and has created a great deal of comment since its adoption, remarks the Newark *Sunday Call*, which makes a special study of horse-car peculiarities. It is scarcely worth while to describe it in detail, because the public is already quite familiar with the arrangement. It is merely a little furnace situated under the seat on the port side of the car amidships. The conductor is stoker and fireman, and he must go overboard to attend to his fire. The uptake runs along under the seat, and passing up through the door-box terminates in a small stack on the hurricane deck. The stove heats the car very effectually in every direction, but more particular in one spot, which almost constantly offers an inviting seat to the last passenger who enters. In fact, this spot may frequently be found vacant when passengers are suspended to the roof by the leathern straps. This vacant seat is almost always directly over the stove, which is scarcely visible from the inside of the car. There is nothing to indicate that the seat is especially reserved, no inverted carpet tacks or bent pins are apparent, and the guileless new arrival swoops down upon it with selfish delight, and for a few moments exults over his fellow-passengers, who, while

hanging to the straps, failed to observe that the seat was vacant. The look of selfish exultation fades gradually from his face, however, as he observes that his fellow-passengers are casting sidelong glances of amused commiseration upon him. He wonders at this for a moment, and then the generous warmth begins to steal through his ulster, while at the same time it dawns upon his mind that every one in the car is prepared to laugh at his discomfiture. He resolves that they shall have no cause to laugh. His coat tails are thick and have shielded him from the cold, why should they not shield him from the heat?

Meanwhile the warmth is increasing; becoming unpleasant—scorching him, in fact; and he shifts uneasily in his seat. He will not get up. No, never. He will not expose himself to the laughter of the vulgar horde whose eyes are concentrated upon him, and whose lips are already curling for the anticipated laugh. No, he will not humiliate himself. He will roast like a martyr at the stake rather than be a subject of ill-timed and vulgar mirth, but it is getting to be intolerable. He shifts to and fro, rocks in his seat, leans forward to inquire the time of day from the stranger opposite, and rises to his feet to get his fare from his pocket; but all these subterfuges only serve to increase the amusement of his fellow passengers, and meanwhile the heat is momentarily growing more oppressive. Finally he can stand it no longer, and springing to his feet he plunges out of the car amid the boisterous laughter of the other passengers. The seat remains vacant to entice another victim, and a moment later a second seat beside it is vacated by a man who seems to think open air and a temperature of 16 degrees preferable to the stifling atmosphere of the car. Another laugh is raised as he makes his exit and the eyes of the people are concentrated on the man who occupied the seat on the other side of the stove. He is half stoic and half salamander, and pays no attention of the mirth around him. Revenge is at hand, however. Two laborers enter the car. They have been toiling in a sewer, and their coarse garments reek with mud and water. They spy the vacant seats, and nudging each other quickly drop into them. Once more the merry passengers assume an air of amused expectancy, but it quickly changes to expressions of annoyance. A pert miss dives into her pocket for her handkerchief and holds it to her pretty little nose. Her example is followed by others, and a moment later two men seek the front platform.

"Begorra, thim shoves are a fine thing, Tiddy," remarks one of the laborers.

"Right ye are, Jerry. They are a droyn' out our clothes splendidly, so they are."

But the effect of the drying-out process was far from pleasant to the other passengers, and even after the conductor entered the car and opened all the

ventilators, several seats were hurriedly vacated.

A man who was smoking his pipe on the rear platform observed a vacant seat in the corner, and quickly knocking the ashes from his pipe thrust it in his pocket and entered the car. He dropped into the corner seat with a placid smile on his face, and pulling a paper from his pocket held it so that the dim light from the lamp above his head would fall on its pages. Three minutes later he jumped to his feet and shouted, "I am on fire!" and grabbing his coat pocket he held it away from his body as if it were filled with red hot coals. The conductor flung the door open, and learning the nature of the trouble, held the skirt of the coat while the man fished the pipe from the pocket in a gingerly manner. A look of blank amazement spread over his face when he found no fire either in the pocket or the pipe, and the conductor solved the mystery by saying:

"You've ben a settin' up agen' that pipe in the corner."

The passengers had one more hearty laugh.—New York Graphic.

THE WORSWICK JOURNAL BOX.

The Higley Car Journal Company of Cleveland, Ohio, has, during the past year, brought out a new anti-friction journal box, under letters patent, issued to their superintendent, Mr. W. W. Worswick, July 13, 1885. Mr. Worswick has been experimenting upon this box for several years, but his ideas were not perfected until last year.

"The box consists of a cast shell, lined on its inner surface with steel, and two end plates, provided on their inner faces with cams, or chilled projections. Steel pins or rollers completely encircle the axle journal, and are of sufficient number and size to entirely fill the annular space between the journal and the inner surface of the box. The rollers are of uniform diametrical size throughout their entire length, and have both ends rounded. They are somewhat shorter than the cylinder in they are placed, so as to afford them a sufficiency of longitudinal slide along with the inward and outward thrusts of the axle. Such a limited sliding of the rollers lessens the grinding and longitudinal wear of the associated parts, and prevents the heating that might otherwise take place. At each rotation of the rollers around the

axle journal, as they approach the bottom of the cylindrical chamber where they are free from pressure, they are brought into a uniform longitudinal position by the cams, before mentioned, on the inner faces of the end plates—these cams being narrow at the top and wider at the bottom, in order to accomplish this result.

There are no complicated parts about this journal box to get out of order, the only parts to wear being the steel rollers and, perhaps (though exceedingly slowly) the steel lining of the box. Both can be easily replaced at very small cost.

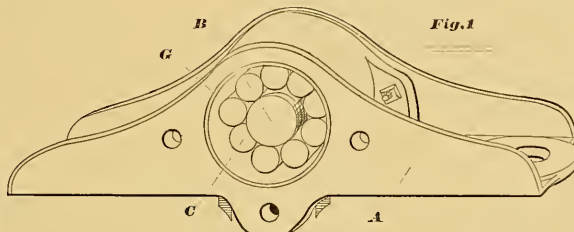
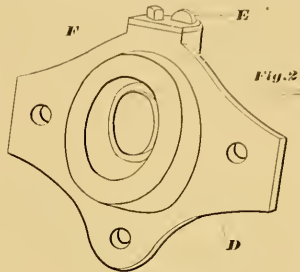

THE WORSWICK JOURNAL.

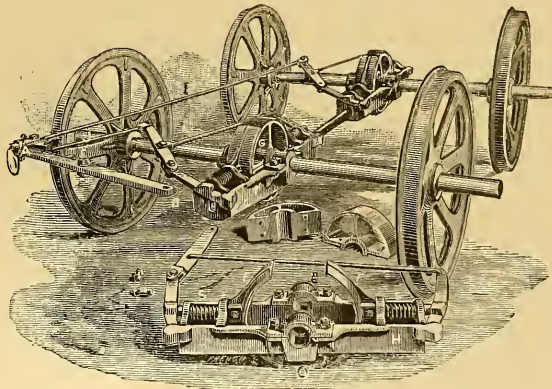

ROFF-EMERY BRAKE.

The box requires no packing, no babbitting, and very little oil.

The device is being tried on several railroads throughout the country, and is giving very good satisfaction, the East Cleveland Railroad Co. having adopted it as standard."

In the accompanying cuts, A repre-

sents the box; B, the axle surrounded by the rollers C; D is the outer end plate, showing the cam on its inner face; F is the hardened or chilled wall of the plate, against which the axle ends occasionally bear; and G is the steel lining of the box.

THE ROFF-EMERY BRAKE

This device* has been in use for some time past on the Toledo street cars. Mr. Roff has kindly furnished the appended description:

"The brake consists of two smooth-faced pulley wheels (made in half sections technically known as "split") which are fastened to the axle of each pair of wheels. Carried by the frame H, which rides upon the axle, are shoes, F, F, lined with leather. The lever, A. B. is attached to the bottom of the car under one platform at the point E, by a stirrup and pivot, and is free to move when actuated by the brake chains and rods attached at A, for one end of the car and at D, for the other. Upon turning the brake handle, the rods I, and J, are moved in the direction A and the shoes, F, F, on both axles are compressed,

gripping the pulleys, G, G. Upon the brake handle being released, the springs S, throw the shoes off the pulleys and the car is free. The axle bearings, O, are lined with babbit metal, easily replaced when worn. The shoes being lined with leather afford good friction and are easily renewed. Leather has been found to wear from six to nine months. The advantages of this brake have been found to be: Saving of wear on wheels, freedom from clogging with snow and ice, quietness and quickness in operation, and the possibility of being used in curves without becoming disarranged. They have been used in Toledo, O., for the past five years, and in Cleveland and Pittsburgh for a lesser time."

*Frank E. Roff, Toledo, O.

EARTH IN THE STABLE.

Nothing will purify and keep a stable so free from odors as the free use of dry earth, and every one keeping horses or cattle will find it pays to keep a heap of it at hand, to be used daily. A few shovelfuls of earth scattered over the floor after cleaning will render the air of the apartments pure and wholesome.—Scientific American.

Passengers nowadays before boarding the Bridge-cars always make affectionate inquiries after the health of the grip.—N. Y. Local.

THE BLACKPOOL ELECTRIC TRAMWAY.

We show here with great detail, the appliances used in running the Blackpool Electric Tramway, designed by Holroyd Smith.

In a full page illustration we show the sectional elevations, the sectional plane, and the cross section of the car; also a part section of the road-way in perspective, and various details relating to the conductor and collector. The conductor consists of two copper tubes of elliptical shape, and having the wide slot for facility of attachment to iron studs which are supported in porcelain insulators; these being attached to blocks of creosoted wood in the sides of the channel. The tubes are fastened to the channel by a wooden pin wedge; and coupled to each other by two metallic wedges, as seen in the cut. At each end of the case there is a switch box, and resistance coils placed under the platform, to regulate the strength of the current and the speed of the car. To reverse the direction in which the car travels, the direction of the current through the armature is reversed. The field magnets are "shunt wound," and always remain magnetized in the same sense. The position of the brushes need not be changed to reverse; they consist of two parallel sets of plates, which are tangent to the commutator and placed upon it by spiral springs. There is but one handle to the two switch boxes, and the driver holds that, so that accident from interference by others should not take place.

We take the engravings from *The Engineer of London*.

Figures 1 to 4 show another arrangement by the same inventor, tried at Manchester. To provide for sharp curves there was a differential gear upon the driving axle. M, is a Siemens motor running 650 turns per minute; E, the combination of box gear, friction clutch, and chain pinion, the steel chain passing on to the chain wheel H, which is free to revolve upon the axle and which carries a differential pinion gearing with the wheels B 1, B 2. The latter is keyed to the sleeve of the loose tram wheel T 2, and the frame is keyed to the axle to

which the second tram wheel T 2 is firmly attached.

The current passes from the underground central conductor by means of a collector, to the motor, and returns from the motor to an adjustable clip, Fig. 2, to

FIG. 2.



the axle and thus to the rails which form the return circuit. There are two half circular conductors placed to each side of the central line, and anything falling into the slit passes between the conductors to the bottom of the trough. In Fig. 3, L, is the surface of the roadway,

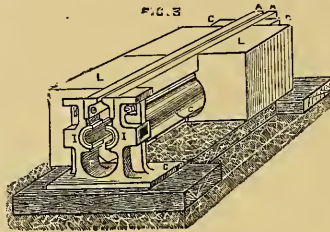

SS are the sleepers, and CC are cast iron chairs serving the double purpose of holding the angle irons, AA, which form the central slot, in position, and provide the attachment for the conductor, which consists of two half tubes of copper insulated from the chairs by the blocks II. The tubes have expansion joints. The spaces G, between the chairs can be flushed to remove obstructions which may have fallen into it, and sump holes, (fig. 4) connected with the street drains,

FIG. 4.

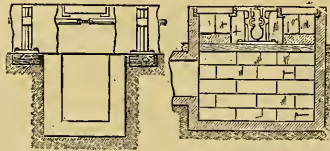

are provided. There are also hand holes for cleaning the channel and for fixing the sliding collector.

These last consist of two pairs of fluted metal rollers pressed into the semi-circular conductor by a knuckle joint and spring. If there was a small obstruction, the fluted roller would revolve; if there was a large one, the leather belts would break and the clip J, by which the current is conveyed to the car, would become detached.

When the motive power is withdrawn the car comes to rest. The collector has steel plates, passing through the central slot, but insulated from the frame of the collector. The upper ends of these plates are held in two iron checks, serving to carry one part of the insulated clip J; the other part being attached to a cable suspended from the

car. Connection between the clip and the collector is made by insulated copper strips placed between the steel plates, as shown. There are two leather belts, one for the forward and the other for the backward motion, and they are strong enough to overcome a slight obstruction, but will break in case of a serious one.

[By special arrangement with the editor and publisher of *Mechanics*, we publish this description and the drawings that accompany it, simultaneously with their appearance in that journal. Editor.]

HOMES.

The local habits of men have a wonderful effect upon manners and morals. The world is a thousand times better off since glass windows, chimneys, wooden floors, have come into use. Various systems of ventilation and innumerable scientific appliances have been introduced by the architect. Nothing has advanced the physical, intellectual and moral condition of the people more than the improvements that have been introduced into the houses in which they live. But while this improvement has been going on, a retrogression has occurred in the peculiar construction of certain houses. We refer to that class known as tenements, flats, and apartments. Many of the criticisms that may be made of the lower grade of these houses may also be applied to the higher class; except that in the best class of apartment houses there is not overcrowding. In regard to the tenement there can be no argument. They simply breed disease, pestilence and immorality. The class known as flats are objectionable because they have so many interior rooms that are badly ventilated. The objection that applies to all these houses is that the rooms are shut in; there are no doorsteps under the control of the occupants, and if they wish to breathe the fresh air they must go on the street. The janitor is the controlling power, and he often exercises the power for many bad purposes. The facilities for the practice of immoral conduct are increased and encouraged. The general features of a home are wanting. The head of a family has no control over his front door. Where there are elevators there is a commingling and huddling together of the occupants that conduces neither to good health nor sound morals. Why people who can rent houses where they may bring up their families with all the associations of a home, live in apartments, we can not divine. Every man who has a family around him should live in a house. Each family should have its own roof, yard and door. These homes are to be found in the suburbs of all cities, and it is here where the people should live. This manner and condition of life is rendered entirely practicable by our systems of street railways. They constitute the great civilizing force of the age—they raise the people to a higher plane of life and happiness.

LOCKWOOD.

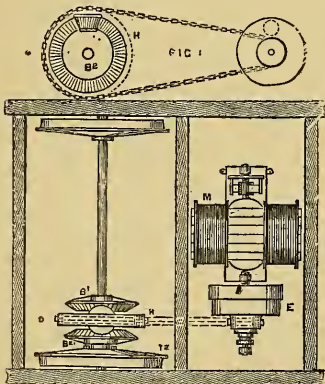

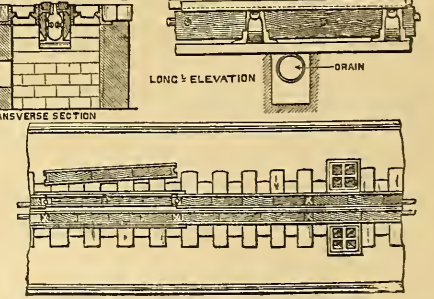
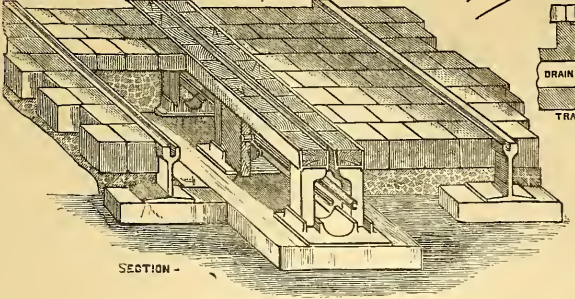
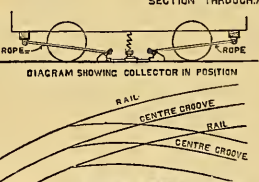
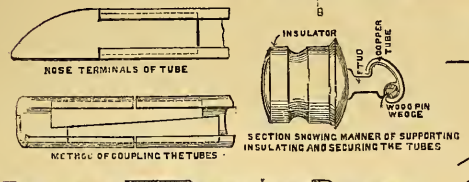
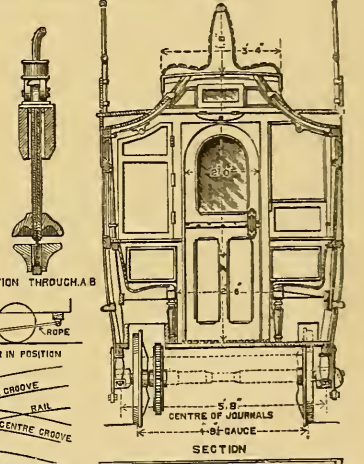
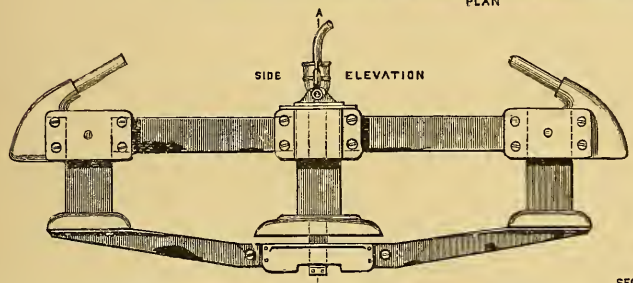
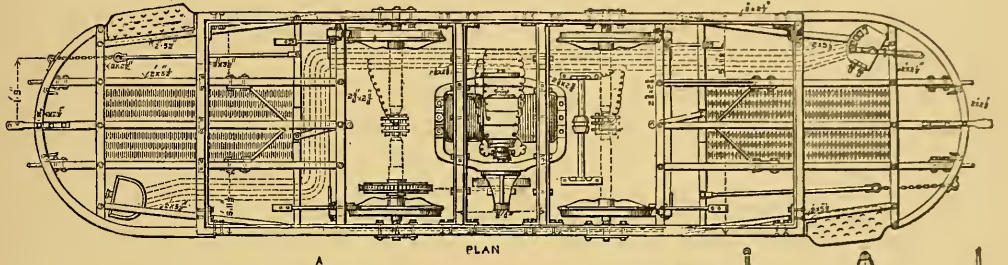
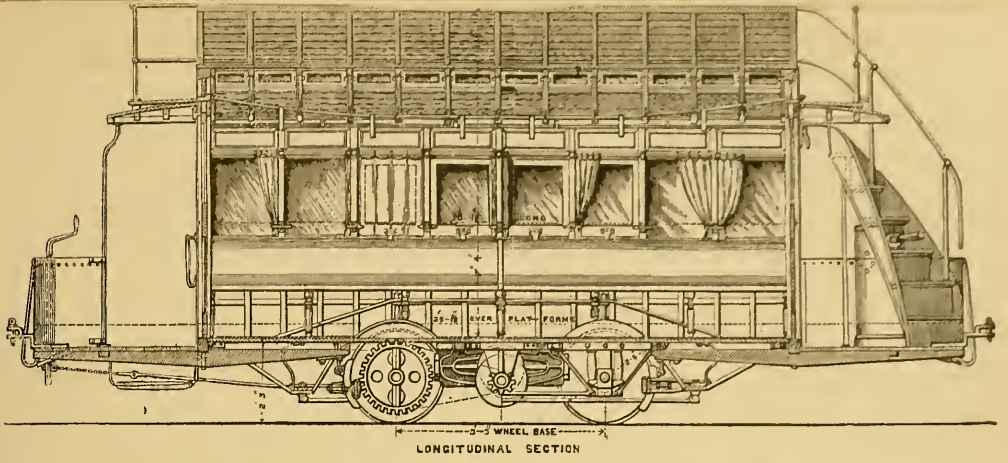

THE BLACKPOOL ELECTRIC TRAMWAY.

AMOUNT OF HORSE POWER USED IN PROPPELLING STREET CARS.

By AUGUSTINE W. WRIGHT.

(Continued from page 8.)

The following returns are taken from the sixteenth annual report of the Massachusetts Board of Railroad Commissioners :

| NAME OF RAILROAD. | Number of horses owned. | Number of miles run. | Number of passengers carried. | Average No. Passengers per round trip. |
|--------------------|-------------------------|----------------------|-------------------------------|--|
| Highland..... | 909 | 1,670,347 | 10,452,441 | 43 |
| Lynn & Boston..... | 608 | 1,052,296 | 6,364,009 | 50 |
| Metropolitan..... | 3,183 | 6,046,879 | 34,574,135 | 38 |
| Middlesex..... | 601 | 1,047,411 | 7,099,882 | 45 |
| South Boston..... | 857 | 1,470,261 | 9,700,299 | 41 |
| Total..... | 6,158 | 11,287,196 | 68,196,776 | 43.4 |

From the above, it appears that the stated average daily distance traveled by the above horses equals 10.04 miles, found by dividing total number of miles run by total number of horses, and this by 365, and multiplying by 2.
 $\frac{11,287,196 \times 2}{6158 \times 365} = 10.04.$

The average number of passengers for these five railroads per round trip being 43.4, per single trip = 21.7. Averaging them at 140 lbs. = 3,038 lbs. Add weight of car, 4,800 lbs., = 7,838 lbs., or 3.919 short tons, which is in excess of my average load of 3.87 tons.

It is fair to assume that these horses are worked to the best advantage, and that this is all that can be expected of a horse upon a tramway.

The stables of the North Chicago Railway are located at or near one end of each line. The horses are in excellent condition. Their mileage could not be increased, even if it was thought desirable, unless they were changed from car to car upon the road, and this would cause delay and inconvenience. They now make two round trips, and could not make more without adding fifty per cent. to the distance they now travel, or changing upon the road.

The foregoing calculations are made for the resistance upon a straight and level track. If the car has to pass up an inclination, the power required is increased.

The following table contains in the first column the rise in feet and tenths of a foot, in one hundred lineal feet. The second column, the resistance over and above that of a level track, caused by the rise in the first column, and the third column contains the resistance of a level track, assuming that this resistance upon a straight and level track is 15.6 pounds. The fourth column contains the total resistance of each grade.

| RAISE IN 100 LINEAL FEET, HORIZONTAL. | Resistance due to grade alone. Pounds. | Resistance on straight and level track. Pounds. | Total resistance. Pounds. |
|---------------------------------------|--|---|---------------------------|
| 0.1..... | 2.0 | 15.6 | 17.6 |
| 0.2..... | 4.0 | 15.6 | 19.6 |
| 0.3..... | 6.0 | 15.6 | 21.6 |
| 0.4..... | 8.0 | 15.6 | 23.6 |
| 0.5..... | 10.0 | 15.6 | 25.6 |
| 0.6..... | 12.0 | 15.6 | 27.6 |
| 0.7..... | 14.0 | 15.6 | 29.6 |
| 0.8..... | 16.0 | 15.6 | 31.6 |
| 0.9..... | 18.0 | 15.6 | 33.6 |
| 1.0..... | 20.0 | 15.6 | 35.6 |
| 2.0..... | 40.0 | 15.6 | 55.6 |
| 3.0..... | 60.0 | 15.6 | 75.6 |
| 4.0..... | 80.0 | 15.6 | 95.6 |
| 5.0..... | 100.0 | 15.6 | 115.6 |
| 6.0..... | 120.0 | 15.6 | 135.6 |
| 7.0..... | 140.0 | 15.6 | 155.6 |
| 8.0..... | 160.0 | 15.6 | 175.6 |
| 9.0..... | 180.0 | 15.6 | 195.6 |
| 10.0..... | 200.0 | 15.6 | 215.6 |

The foregoing table contains the resistance upon various grades; but when animal power is used to propel a car, the power that the horse can himself exert is lessened with the increasing grade, so that at a certain inclination the horse could only propel himself.

Upon grades, therefore, the force required to propel each ton of car and its load is *increased* at the rate shown in column two of the above table, and the ability of the horse to draw the load is *decreased*. If we assume that the horse weighs 1,000 lbs., and exerts a force equal to 100 lbs. upon a level—

| | |
|---|---------|
| Upon a grade of one foot in one hundred he can exert a force of | 90 lbs. |
| “ “ “ two feet “ “ “ “ “ “ “ “ “ “ | 80 “ |
| “ “ “ three “ “ “ “ “ “ “ “ “ “ | 70 “ |
| “ “ “ four “ “ “ “ “ “ “ “ “ “ | 60 “ |
| “ “ “ five “ “ “ “ “ “ “ “ “ “ | 50 “ |
| “ “ “ six “ “ “ “ “ “ “ “ “ “ | 40 “ |
| “ “ “ seven “ “ “ “ “ “ “ “ “ “ | 30 “ |
| “ “ “ eight “ “ “ “ “ “ “ “ “ “ | 20 “ |
| “ “ “ nine “ “ “ “ “ “ “ “ “ “ | 10 “ |
| “ “ “ ten “ “ “ “ “ “ “ “ “ “ | 0 “ |

Therefore, if he weighs 1,000 lbs., and can exert a force of 100 lbs. upon a level, in surmounting a grade of 10 feet in 100 feet horizontal, all his strength would be exerted to propel himself, and he could not draw any load.

The assumption upon which the last table is figured, you will notice, is that the horse weighs 1,000 lbs. and exerts a force of 100 lbs. This force is exhausted in raising his own weight up a grade of ten feet in one hundred feet horizontal.

The estimates, already quoted, place his power at from one hundred to one hundred and fifty pounds, at a speed of two and a half miles per hour.

For a *short* distance he is capable of exerting several times this force.

My own experiments gave 1,530.9 pounds.

Cresy estimates it at from 300 to 525 kilogrammes, or 661.39 to 1,643.56 pounds. Haswell estimates it at 1,540 pounds.

It may, therefore, be safely estimated that for a short “spurt” at slow speed, he can exert *ten times* the force that he could exert during ten hours, at a speed of two and a half miles per hour.

CONSTRUCTION, EQUIPMENT AND MAINTENANCE OF AMERICAN STREET RAILWAYS.

By AUGUSTINE W. WRIGHT.

(Continued from page 7.)

It was further desirable to ascertain the degree of dependence that might be placed on nailing two pieces together, and Mr. Bevan kindly undertook to make some trials. Two pieces of Christiana deal, seven-eighths of an inch thick, were nailed together with two six-penny nails, and a longitudinal force in the plane of the joint, and consequently at right angles to the direction of the nails, was applied to cause the joint to slide; it required a force of 712 lbs., and the time was fifteen minutes; the nails curved a little and were then drawn.

“Another experiment was made in the same manner with dry oak, an inch thick, in which the force required was 1,009 lbs.; the six-penny nails curved and were drawn by that force.

“Dry, sound ash, an inch thick, joined in the same manner by two six-penny nails, bore 1,220 pounds thirty minutes without sensibly yielding; but when the stress was increased to 1,420 pounds, the pieces separated with an easy and gradual slide, curving and drawing the nails same as before, one of which broke.”

Rankin, in his “Civil Engineering,” p. 460, quotes the above, and says: “So far as these results can be expressed by a general law they seem to indicate that the force required to draw a nail driven across the grain of a given sort of wood varies nearly as the *cube of the square root of the depth to which it is driven*, and that it increases with the diameter of the nail, but in a manner that has not yet been expressed by a mathematical law.”

The following table gives the results of tests made by Arthur M. Wellington, C. E., conducted as follows: The test blocks were reduced to a uniform thickness of four and a quarter inches, this thickness being just sufficient to give a full bearing to the *parallel* sides of the spike when driven to the usual depth, and allow the point of the spike to project outwards. It was considered that the beveled point could add very little to the holding power of the spike, and it was desired to press the spike out again by direct pressure after turning the block over. The force was applied by a loaded lever, an iron bar fourteen feet long and 1½x4 inches section, the fulcrum being at one end and the spike to be driven or expelled, placed two feet from it. A fulcrum was obtained by a mortise in the frame of the shop. An apparatus of this form works well in every respect.

Table showing tests of various woods for resistance to driving and pulling spikes treated and untreated by the Thilmeny (Sulphate of Baryta) process. All test pieces of the same kind of wood were cut from the same stick. All the woods, except as specified, had been cut six or eight months, and were partially seasoned. Spikes used for tests were of standard size and form, viz.: 5/8x1 1/8. Thickness of blocks, 4 1/4 inches.

| Kind of wood in order of resistance to extracting spike. | Actual resistance in pounds. | | | | | | Relative resistance (av. b'th prp d&e unprp'd) to king force from green oak (6523) as 1. |
|--|------------------------------|-------------------|-------------------|-------------------|----------------------------|-----------------|--|
| | Natural wood untreated. | | Prepared wood. | | Av. both prep'd & unprp'd. | | |
| | To driving spike. | To pulling spike. | To driving spike. | To pulling spike. | To drv'g spike. | To pul'g spike. | |
| Beech..... | 5216 6743 | 5979 6285 | 5978 7288 | 7056 7472 | 8873 8267 | 8,420 | 1.08 |
| White oak (green) | 5970 5970 | 5820 5866 | 6523 | | 5820 5523 | 6523 | 1.00 |
| Pin oak..... | 5216 5216 | 5366 6638 | 6553 | 6117 4580 | 6235 6201 | 6,201 | 0.815 |
| White ash..... | 5933 5933 | 5953 4560 | 4560 | 5588 5978 | 6283 | (Split.) | 0.925 |
| White oak well seasoned..... | 6433 6433 | 6433 3435 | 4281 | | 6433 | 4281 | 0.98 |
| Black ash..... | 3996 4902 | 4099 4668 | 4638 | 4453 4453 | 4447 | 3390 | 0.53 |
| Elm..... | 4453 4738 | 4666 3943 | 3660 | 4453 4300 | 4300 | 4123 | 0.68 |
| Chestnut (green). | 3996 3386 | 3591 3790 | 3260 | 2725 3380 | 3380 | 3691 | 0.56 |
| Soft maple..... | 4148 3538 | 3843 3648 | 3111 | 3843 3448 | 3645 | 2725 | 0.575 |
| Sycamore..... | 4109 3493 | 3798 3188 | 3188 | 3591 3383 | 3383 | 1968 | 0.385 |
| Hemlock..... | 2910 2910 | 1996 1996 | 1996 | 1996 | | 2910 | 0.44 |

It will be noticed that Mr. Wellington found the force required to draw spikes 9/16x1 1/8 inches, driven 4 1/4 inches into seasoned oak, to be 4,281 pounds. Same spikes, etc., in unseasoned oak, 6,523 pounds. Funk gave as the result of many experiments with spikes 1/2x1 1/2 inch, driven 4 1/2 inches into yellow pine, 3,000 pounds, and twice this amount, or 6,000, for oak. If his experiment was with unseasoned oak, these tests do not differ materially.

Some of the deductions drawn by Wellington from the above experiments are as follows:

"A beach tie, if effectually preserved from rotting, would be a better tie than white oak, and a red or pin oak tie about as good. Elm, black and white ash, if effectually preserved, will hold a spike about two-thirds as well as beech or oak, and about one-third better than chestnut. Soft maple and sycamore hold a spike about four-fifths as well as chestnut, about two-fifths as well as oak or beech, and about one-half better than hemlock. Seasoned white oak is about one-third less effective than green timber in holding a spike. The force required to drive a spike and to pull it out are as nearly as may be equal with hard woods, it being often the case that considerably more dead load is required to push out the spike than to drive it in. On the other hand, with the softer woods the force required to drive the spike is about one-fifth greater. It is a peculiarity which may be frequently noticed in this table that a spike which has required a greater force than another to drive it into the

same wood will require less force to drive it out, and vice versa. No difference could be discovered to push out a spike on account of the difference in time that the spike had been driven. Some of the spikes were pushed out immediately, some left in several hours some were left in over night; but no difference on that account could be discovered."

Regarding screws, Tredgold, p. 190, says: "The adoption of screws instead of common nails is a considerable improvement. The following experiments on the force necessary to draw screws of iron, commonly called wood screws, out of given depths of wood, were made by Mr. Bevan. The screws he used were about two inches in length, 7/16 diameter at the exterior of the threads, 1/16 diameter at the bottom; the depth of the worm or thread being 1 1/8, and the number of threads in one inch, 12. They were passed through pieces of wood exactly half an inch in thickness, and drawn out by the weights stated in the following table:

| | |
|---------------------|-------------|
| Dry beech..... | 460 pounds. |
| Dry beech..... | 790 " |
| Dry, sound ash..... | 790 " |
| Dry oak..... | 760 " |
| Dry mahogany..... | 770 " |
| Dry elm..... | 665 " |
| Dry sycamore..... | 830 " |

The weights were supported about two minutes before the screws were extracted. He found the force required to draw similar screws out of deal and the softer woods about half the above. The force necessary to cause pieces screwed together to slide at the joining was also determined; the pieces being joined by two screws; the resultant of the force coinciding with the plane of the joint, and in line with the plane of the screws. With Christiana deal, seven-eighths of an inch thick, joined by two screws, one and five-eighths of an inch in length and five-fortieths of an inch in diameter within the worm, a load of 1,000 pounds gradually applied broke both the screws at the line of joint, after elongating the interior of the hole and sliding about six-tenths.

With very dry, seasoned oak, one inch thick, two screws, 1 5/8 long and 7/16 diameter within the thread, bore 1,000 lbs. for ten minutes without any signs of yielding; with 1,137 lbs. both screws broke in two places, each screw about 2/10 of an inch within each piece of wood; the holes were a little elongated.

With dry and sound ash, one inch thick, with screws 2 1/2 inches long, passing 1/4 of an inch through one of the pieces, the diameter at bottom of the worm 7/16; the load begun with was 1,224 pounds, gradually increased for two hours to 2,661 pounds; this produced a slow and moderate sliding, not separation, the screws being neither drawn nor broken, but probably would have been if not removed on account of night coming on, and putting an end to the experiment.

In the tests detailed in tables one, two and three, I used the same lever, but instead of spring balances, attached a box into which I put weights of iron until the screws were pulled and then ascertained the weight on Fairbanks scales. Table "one." Taking dry white ash as a standard, these tests tend to show that with the same sized screw, black walnut requires nearly the same power to extract the screw. A closer grained dry white ash required 1.08 times this power; dry red oak, 1.35; dry Georgia pine, 1.06; dry Norway pine, 0.60. In each one of these tests, I bored a hole the size of the shaft of the screw. A test of the same screw driven into dry Norway pine (the same piece of timber), without boring, was extracted by 0.35 of the power required for dry ash, or about 1/2 of the power required when the screw was screwed into a bored hole in the same stick. This proves the mistake made by many carpenters who drive a screw nearly home. Table "two" gives the power required to extract various sizes of screws from the same wood, the last column containing the per centages taking a 1 1/2-inch screw No. 10 as 1.00. Table "three" contains tests of the power required to extract "drive" screws as made by Shumway, Burgess & Co. driven into the wood, ordinary "lag" screws screwed into the wood, and spikes 1/2

III.

THE STRINGER.

The preceding remarks apply with equal force to the stringer, when it is of wood. I use Norway pine and think ten years is probably its average life. The quality of the soil, whether porous or compact; gravel, sand or clay, has more to do with the life of the stringer than that of the cross-tie, for, being nearer the surface it is reached more easily and affected by the alternate wetness or dryness. Few, if any, pavements remain water-tight, and more or less water penetrates to the foundation. Sprinkling the tracks with water, as practiced in most cities, so that the stringers are continually wet, prolongs their life. The selection of the timber itself has much to do with its service. For instance, my stringers are 5x7 inches. Very few sticks are entirely free from sapwood. The sapwood is the first to rot, and the top of the stringer, immediately under the rail, being most exposed, rots first. My stringers are dressed to pattern, planed on three sides. By selecting the *heart* of each stick to carry the head of the rail, where the car-wheel travels, I get increased service from the wood.

The top of the stringer should not be planed at right angles with its side, but should be inclined towards the center of the horse-path, so that the wheel will bear equally across the entire head; if anything a little more upon the *outside*. The car-wheel is cast with a cone shape; it is larger at the gauge-line than it is at the outside of the rail. This is supposed to lessen the resistance in passing around curves. My car-wheels are coned $\frac{1}{8}$ inch in two inches. My rail is five inches wide (step rail) and I incline the top of the stringer $\frac{3}{8}$ of an inch in its width of five inches. The width of the wooden stringer is fixed by the width of the rail used, for they should be the same. The depth of the stringer should be such as to bring the top of the cross-tie beneath the pavement used. Seven or eight inches in depth suffices for this purpose, and the timber is strong enough to transmit the load upon it to the cross-ties. Mr. Wm. Wharton Jr. recommends that the cross-ties should be spaced five feet between centers. Some are laid three feet, four feet, five feet, six feet, and seven feet, between centers. I prefer four feet for a metropolitan line.

MAINTAINING GAUGE.

Various methods are in use for holding the track to gauge. I prefer angle-irons, and place four upon each cross-tie. The two *inside* of the stringer in my practice, are fastened to the cross-tie by two boat spikes, each $\frac{1}{4}$ of an inch square and five inches long, with one spike driven into the side of the stringer, three inches long, $\frac{1}{16}$ square. The angle-iron upon the *outside* of the stringer I make the full height of the stringer and fasten it with three spikes, $\frac{5}{16}$ of an inch square and five inches long, to the cross-tie, and one spike into the stringer. I use old rail spikes for the latter purpose, $\frac{1}{2}$ inch square. The spikes should be first driven into the stringer and then those into the ties. It is not necessary to enlarge upon the importance of having the knee fit snugly against the stringer. With a side-bearing rail, such as is used in Chicago, the weight of the car and its load is carried upon the outside $1\frac{1}{2}$ inch of the stringer, and the tendency is to tip over. This is met and resisted by the aforesaid knees. The car wheels, unless the track be tight gauge, have little if any tendency to cause spreading or widening of the gauge. Not so with heavily loaded wagons in attempting to turn out of the track. The force exerted by the front wheels of such a load, drawn by four or more horses, is considerable. One-half the weight of the vehicle and its load must be raised over the head of the rail, one inch with us. The horses act with a leverage equal to the distance from the end of the tongue to the center of the front wheels; and this is the great force tending to spread our tracks. It is applied at the inside corner of the head of the rail, and the tendency is to turn the stringer over sideways. If the outside knees be firmly spiked and held to their position the lower inside corner of the stringer will come in, the top of the outside knee acting as a fulcrum. To prevent this motion a small knee is used on the inside

of the stringer, and this force acting at the bottom of the said stringer, it is only necessary to have these knees high enough to get a small spike into the stringer without splitting off its corner. The use of cast-iron knees began before the existence of street railways, when steam railroads were built with strap iron for a wearing surface to protect the timber structure of which the railroad was composed. Upon the Utica and Syracuse R. R., previous to 1843, these knees weighed 15 lb. and at the stringer joint 17 lb. It is quite common upon street railways to make a knee with a wide top, for use at stringer joints so that a spike can be driven into the stringers at each side of the joint. The vibration of the pavement or track will cause the stringers to work up unless they are securely held down.

Upon some roads, rods of round iron $\frac{3}{8}$ inch in diameter, are used instead of knees, to hold the track to gauge. A slot is sawed into the stringer at the top, seven feet center to center, to let in this round rod, which has upset ends with wrought-iron washers, say four inches square, upon it. These washers come upon the outside of each stringer, but are not adjustable for length. If the stringer be *just* the width intended, the washers bear, but if the stringer prove a little too wide, its side has to be dressed, and I have never seen any pains taken to cut off *just* enough. The men always cut out more than necessary, so to be sure to have enough, and then insert a chip to fill the void. This chip soon drops out, or at best rots, and the track spreads. The same result is reached if the stringer be narrow in the first place. Then these rods are more or less in the way of paving, and if they get bent, narrowed gauge results.

A bar of iron $1\frac{3}{8}$ inches deep, by $\frac{3}{8}$ inch wide has been used in Boston. It is twisted half way round at each end and let into the top of the stringer $\frac{3}{8}$ of an inch, flush with the same. It has a square hole at each end. The stringers having been put to gauge, spikes are driven into them through the aforesaid holes; but I am informed that the vibration of the rail over these spikes loosens them.

Upon light country street railways, boat spikes are driven through the stringers into the ties beneath before the rails are put on. This construction makes it difficult to remove a tie for repairs, etc., for the boat spike can not be gotten out without first removing the rail which covers its head.

Tree nails of hard wood have also been used, and also blocks of wood to take the place of the iron knees.

JOINT CHAIRS.

Joint chairs are made of various shapes and materials. Upon light roads, simple plates of wrought iron are used, placed on top of the stringer and allowed to settle into it. Other roads use wrought-iron or steel chairs, eighteen inches long and rolled, with sides projecting above and below. The former to hold the rails in line with each other and the latter to hold them in line with the stringer beneath. Some rails have a hollow head. In that case, these joint chairs are made of cast iron. No lip upon the side is necessary, but it will be found advantageous to have the point chilled where the rails meet. Two-thirds of the length of the chair, in a track where the cars always pass in the same direction, should be placed under the end of the rail against the traffic, as experience demonstrates that that end receives a blow from the car wheel, and the rail cuts into the chair more rapidly than the rail upon which the wheel bears, and consequently needs more iron support.

To be continued.

NO WHIPS.

Mr. Wm. C. RICHARDSON, president of the Atlantic Avenue Road, Brooklyn, demonstrated the good sense with which he is usually credited, when in his testimony before the Commissioner of Labor Statistics, the other day, he said, in answer to the question: "Are drivers expected to carry a whip?" "On the contrary, it is my desire that no driver shall carry one." * * * "A merciful man is merciful to his beast," and, judging from this reply, we should set Mr. Richardson down as a merciful man, in spite of Mr. Peck.

MR. CREGIER ASSUMES HIS NEW POSITION.

Mr. DeWitt C. Cregier is one of those fortunate few who do not have to die before their fellow-men find out their true value. There are few public officials who have made more or sincerer friends than the ex-Commissioner of Public Works of Chicago, now Superintendent of the West Division Railway Lines. The finale of his thirty-third year in the service of the city was graceful and highly complimentary to him. First, on the afternoon of his last day as head of the department, an informal meeting was called in the councils chambers, where the Mayor, in a pleasant and friendly speech, presented him, on behalf of the Department of Public Works, a handsome silver service, worth \$1,000. This was followed, in the evening (6th inst.), by a banquet at the Palmer House, tendered Mr. Cregier by his friends, and, as might be supposed, these included most of the prominent people of Chicago.

The occasion was a notable one, and no one had, or could have, any but friendly and commendatory words for the guest of the occasion. Mayor Elwood, of Joliet, sent the following message :

"D. C. CREGIER: May you have little snow, bright days, and the success your energy, integrity and manliness entitle you to in driving your four-in-hand over your West Division. Regret I can not be with you to-night."

Mayor Harrison made a pleasant speech on the text, "Our guest—the oldest servant of the youngest metropolis," to which Mr. Cregier responded in a manly earnest speech.

"Health and success to Mr. Cregier in his new vocation," was drank by all standing.

W. K. Sullivan spoke briefly of "The Press—the constant reminder of public functionaries that they are human and that their tenure is uncertain."

Mr. Wirt Dexter responded to the toast, "Railroads—broad and narrow gauge, grip, surface, traction, ballasted or unballasted, watered, or just plain; they all center in Chicago."

The other regular toasts were: "Chicago's Water Supply—If Lake Michigan holds out, no Chicagoans (not from Kentucky) need go thirsty." Response by Gen. Fitz-Simons. "The Federal and Municipal Official—Public office is a private burden, but the self-sacrificing patriot is always abroad;" response by the Hon. R. S. Tuthill. "Chicago's Six Per Cent. Water Bonds—Never watered and good as wheat;" response by T. T. Gurney. "The Public Works Department—It paved the way to Chicago's glory;" response by Redmond Prindiville.

RAMBLINGS IN DIXIE.

BY E. V. CAVELL.

1—Lexington, Ky.

Six years ago the city of Lexington, Ky., had no better facilities for rapid transit than those afforded by rumbling old stages, or semi-convolescent hacks. But the city was not doomed to be

passed by on the other side, during the march of progress, and one day its star shone out brighter than usual, shedding its awakening light into the minds of Messrs. Alex. Pearson, J. E. Keller, J. H. Hopson, Thomas Bradley, et al. Brilliant idea: "Build a street railroad!" Dreams of fabulous dividends floated before their eyes, brighter than the auriferous visions of those poor fellows who trod wearily the burning plains of Nebraska, in the soul-stirring days of '59, when Pike's Peak was, to their overwrought imagination, a mountain of virgin gold, before which the glitter of the Escorial sank into minor glory. The dreams were all right, the idea immense; but when one of the projectors, caustic and witty, quietly laid the scheme, in a business-like manner before the others, with the remark, "Gentlemen, pray, who is to pay?" it seemed as though a playful iceberg had struck the enterprise. The enthusiasm did not actually die, but became "comafied," and matters looked as though its life's fitful fever was over. Stock subscription books were opened, however, and kept open, and although everyone wanted the street railway, they were public-spirited enough to want to build it with the other fellow's cash. Fifty thousand dollars was the amount required to consummate the scheme, but it appeared well nigh impossible to raise that sum. About this time the shadow of the cross (Col. John Cross) fell upon the city, and his attention was directed to the enterprise. After a close investigation Col. Cross concluded that there was something in it, although he was too conservative to enthuse like our old friend, Col. Sellers. He made a proposition to build the road, provided he could have a majority of the stock, \$25,000, which was accepted, and in a very short time a line was completed from the race track to the depot of the C., N. O. & T. P. R. R., the first car running over the road on the 22d day of August, 1882. The inauguration of this line was quickly followed by the construction of one from the cemetery to Woodland Park, and another connecting Hamilton College with the Main street line.

About this time, as if to test the faith of those interested in the scheme, the fire-king swooped down and destroyed the stables of the company, together with over two dozen cars; but, like a phoenix from the ruins, quickly it rose from the ashes, purchased a more eligible and suitable location, and at once erected two substantial brick stables; contracted for new cars, and resumed operations. Since that time several important extensions have been made; one from the Main street line to the State College, on Limestone street; one from Broadway to the Fair grounds, and one from Third street to the race track.

Col. Cross, being interested in a number of stage and street car lines, had but little time to devote to his line in Lexington, so he placed his interest there in the hands of his nephew, Mr. Albert

Cross, to whose judicious management, executive ability and faithful services is due the present satisfactory state of the enterprise.

A PLEA FOR THE HORSE.

HORSE AND MAN:—*Their Mutual Dependence and Duties*, by the Rev. J. G. Wood—8 vo., 339 pp., J. B. Lippincott & Co., Philadelphia.

The reverend author has written some very excellent books, but none more noble in purpose, or more ably put together, than the one before us. There are probably no scientific works more generally read than some of the writings of this author, whose "Homes Without Hands," is a household standard.

This book is an appeal, based on arguments and examples without number, against the various "improvements" to which horses are subjected in our stables and smithies, under our saddles, and between the shafts of our vehicles; and, as there is not, among all modern institutions, a greater employer of horse-flesh than the street-railway, we are glad to be able to introduce to the readers of the GAZETTE a new and really excellent treatise on horse-care and horse-humanity (if we may coin the term). As an author can always best state his own case, we will quote extensively from the book, and let the reader judge of the argument as we proceed.

In his preface, Mr. Wood says: "I only ask the reader to bear in mind that I pretend to no discoveries, and advance no theories. I simply state facts, offer evidence of those facts; adduce proofs of that evidence, state how and where these proofs can be verified, and then leave the impartial reader to draw his own conclusions." We shall pursue the same course, only supplying the necessary connections between the quotations.

The first chapter of the book is devoted to an outline of the general anatomy of the horse, and is illustrated with excellent engravings. In the second chapter, the special point of the introductory argument is reached in the foot and hoof of the animal, as follows: "Now for the structure of the hoof, or nail, of the horse.

"Instead of being a mere lump of horn, it is a sort of horny case or box, intended to protect the sensitive structure which it surrounds. The offices which it serves are many, though several of those offices are practically ignored by civilized man." He then proceeds to show by various examples and incidents that the horse's unshod hoof is adapted for service in all possible situations, and for all purposes—even to climbing steep rocks.

"Here are some of the offices which have to be performed by the horse's hoof, together with the reasons for those offices.

"The horse is a very heavy animal, and therefore the hoof which carries that weight must be strong.

"Strength might be obtained by solidity, but solidity would involve weight,

so that the horse would have to lift several ounces each time that he made a step. This may not seem very much in detail, but in the aggregate it is very considerable, indeed.

"Moreover, the power which is required to raise the foot, is very much in excess of the weight to be lifted. The hoof is at the extremity of a long lever, the power of which is applied at the end of the shorter arm, so that, as has been roughly calculated, an ounce on the hoof is equivalent to a pound on the back. The horse is not furnished with muscles fitted for lifting heavy weights at the ends of its legs, and therefore the foot is carefully made as light as possible. The hoof, therefore, must be LIGHT.

"It must be HARD, so as to endure contact with sharp-edged rocks, a sun-baked soil, or loose stones.

"It must be ELASTIC, in order to obviate the jar which would be caused by the concussion of a hard and unyielding substance with the hard and unyielding ground.

"It must be SHARP-EDGED, to give the animal a footing on rocks or uneven ground.

"It must be CLINGING, so as to save the horse from falling on a wet, slippery, or frozen surface.

"Lastly, as the hoof must be perpetually worn away, it must be capable of SELF-REPAIR in exact proportion to the loss of material. All these apparently conflicting characteristics are to be found in the hoof of the animal in its natural state, and there is not one of them which man does not impair, or actually annul, in his attempt to improve upon nature."

Going still more minutely into the anatomy of the leg, foot and hoof, the author shows how nature has provided each of the requisites just set down as necessary for fulfilling the purposes of a hoof; and in recapitulation, he says: "Therefore, unless the front of the hoof be regularly worn away, as was intended by the Creator, or cut away by the knife, it grows to an abnormal length, and prevents the animal from walking in a natural manner."

Proceeding a step further, "another needful characteristic of the hoof now comes before us. In order to avoid jarring the brain and spinal cord at each step, it is necessary that the hoof should be ELASTIC.

"As I have already mentioned, the general elasticity of the whole frame is largely due to the mode in which the joints of the limbs are made. The peculiar angle at which the fetlock is set, has also an influence on the elasticity, and horsemen are well aware that when the pastern is too upright, they feel jarred at every step." * * * * *

"But something more than the mere arrangement of the bones is required. The portion of the hoof which comes first to the ground at each step, must be elastic; and this requirement brings us to one of the most important portions

of the horse's hoof, it being the chief source of elasticity: This is the frog." * * * * * "When the hoof is left in its natural form the frog fills up a considerable portion of the hoof; it is not hard, like the wall, which, if properly treated, becomes so hard that a knife will scarcely touch it, but is quite soft and elastic, feeling when handled, much like vulcanized India-rubber.

"As the horse steps, the weight first comes on the hinder, or heel portion of the frog, then upon the centre, and afterwards upon the wall.

"Two objects are fulfilled by this structure. Firstly, by means of the elastic material interposed between the horse and the ground the animal treads softly, and does not 'jar' the body, as would be the case if the bearing came first on the wall. Horses are instinctively aware of this fact, and when at liberty in a field they may be seen shuffling about in order to obtain the central bearing for which the hoof was made." * * * * *

"The next object is to prevent the horse from slipping on wet or smooth surfaces. For this object the frog is wonderfully adapted, as it will cling to ice or a wet boulder, and enable the animal to traverse a slippery surface with perfect freedom.

"When, therefore, the hoof of an unshod horse comes to the ground, and the weight of the animal rests upon it, the hoof has a double hold, the frog in the centre clinging like India-robber, and the sharp-edged wall holding to the least roughness or irregularity.

"Like the wall, the frog is subject to perpetual wear, and therefore must be perpetually renewed. It is not, however, rubbed down by friction, as is the wall, but its outer portions continually become detached in little loose flaps, which hang on for a time and then break away altogether, so as to make way for the fresh material which has been formed above them.

[To be continued.]

SALE OF THE PEOPLE'S PASSENGER RAILWAY, PHILADELPHIA.

On Saturday, Jan. 18th, Chas. J. Harrah, president of the People's Passenger Railway company, sold his stock in that company, through Wm. H. Shelmerdine and Robert N. Carson, composing the banking house of Wm. H. Shelmerdine & Co., to a syndicate comprising, among others, stockholders of the Lombard and South Streets Passenger Railway. The other directors of the People's line also sold most of their stock to the syndicate, and then Mr. Harrah resigned the presidency of the road, and he and the other directors retired from the management of the People's company. It is said that the purchase by the syndicate amounts to about two-thirds of all the stock. The directors who resigned with Mr. Harrah were Joseph Morgan, James W. M. Cardeza, Isaac Schlichter and C. J. Harrah, Jr.

The resignations were followed by an election at the office of the People's company, Eighth and Dauphin streets, at 3 o'clock, p. m. John B. Parsons, president of the Lombard and South Streets Passenger Railway company, was elected

president, and Wm. H. Shelmerdine, Robert N. Carson, Edward Samuel and Howard A. Stevenson were, with Mr. Parsons, chosen at the new board of directors. The new management took immediate control of the road, and one of the first changes made was to order that straw be put in all the cars of the People's company yesterday morning. This order was carried out. President Harrah did not allow the use of straw in the cars.

Of the new directors, Mr. Stevenson was president of the Green and Coates streets line until it was leased to the People's company. Mr. Stevenson, Mr. Samuel and Mr. Carson, are said to be financially interested in the Lombard and South.

The Green and Coates and the Germantown (Fourth and Eighth) lines being leased by the People's, the new syndicate controls those roads. Its other lines are the Callowhill street, Girard avenue and Norris street, and Susquehanna avenue. It is reported that the syndicate propose to connect these roads with the Lombard and South and its branches, and thus form a rival of the Traction company. The fare charged on the Lombard and South is five cents. The report that the syndicate contemplates a general reduction of fare to five cents could not be confirmed.

The Lombard and South, it is said, has privileges under its charter in West Philadelphia which can make it a rival of the Traction company there. Its cars pass over the South street bridge. The cars of the People's line run to Fairmount park by way of Fairmount avenue, Girard avenue and Callowhill street.

Mr. Harrah was elected to succeed George F. Work as president of the People's line (Callowhill street) in October, 1882. He bought about that time the greater part of 60,000 shares of common stock, paying for it, on an average, about \$14 a share. For a time after his election as president the price was below that figure, but on Friday last 3195 shares were sold at 39½ a share, a 39½ a 34½, seller 60 days, closing at 35 bid, a decline of 4½. It is said that Mr. Harrah got about the present market price for his stock on Saturday.

One of the syndicate said yesterday that the greater part of the stock purchased was bought by Messrs. Shelmerdine and Carson for themselves. They are among the principal stockholders of the Lombard and South. He said that the purchase was made as an investment, and without consideration of the question of consolidating the People's and the Lombard and South, although, no doubt all the roads controlled by the syndicate would be conducted "in harmony," and with the view of having one assist the other. Possibly there would be transfers of passengers between the Fourth and Eighth and the Lombard and South, but if so, the transferred passengers would probably be charged six cents fare. The question of a general reduction to five cent fares had not been considered, and probably would not be for some time, although eventually, if there should be a prospect of success for a "five cent experiment," it was likely that it would be tried. The People's line, owing to the manner in which President Harrah had put the profits in "betterments," was said to be now in very good condition.—Ledger.

We have made preparations to illustrate in our next number a successful cable plant.

THE
STREET RAILWAY
GAZETTE.

COPYRIGHTED, FEBRUARY, 1886.

MONTHLY, \$2.00 PER YEAR.

WALDEN, MONROE & CO.,
PUBLISHERS.

GENERAL OFFICES.

NEW YORK, - - - - 29 Park Row.
Thomas Walden, Resident Partner.
Business Manager.

CHICAGO, - - - - 12 Lakeside Building.
P. G. Monroe, Resident Partner.
E. V. Cavell, Business Manager.

George B. Heckel, - - }
R. Grimshaw, - - } Editors.
Henry C. Lockwood, - - }
J. D. Nolan, - - }

BRANCH OFFICES.

Philadelphia, Pa., 419 Walnut Street, J. Waterkyn, Manager.

Pittsburgh, Pa., James Loughran.

St. Louis, Mo., 709 Olive St. Frank Trainor, Manager.

Atlanta, Ga., 68 Alabama St., William Minigerode, Manager, Chamber of Commerce Building.

St. Paul, Minn., 558 Drape Block. V. R. Benham, Jr., Manager.

San Francisco, Cal., 320 O'Farrel St., G. W. Fairchild, Manager.

CHICAGO'S STREET RAILWAY
FUTURE.

A glance at our columns of *pointers* in this and the last number of the GAZETTE must suggest to any one interested that Chicago is manifesting a great interest in the subject of intra-mural traffic. Until a couple of years ago, no one seemed to think of attempting to dispute the absolute ownership of tramway privileges in this city, to the three existent companies which harmoniously divided between them the passenger carrying trade of the North, South and West divisions of the city, respectively. But the Chicago Passenger Railway finally secured a foothold on the West-side, and in less than a year, projects for new lines and extensions of the existing ones (including the latest comer), have sprung up on every hand, so that it is safe to predict unwonted activity in street railway building during the next few years.

Nor is it probable that surface roads alone will occupy the attention of capitalists and speculators. Already the air is filled with rumors of plans and franchises for a network of elevated or underground lines to drain the city and tap the tributary suburbs in every direction. And it is more than probable, in fact it is almost certain, that one or another of these schemes will mature and take definite shape in the very early future.

He who runs may read the meaning of this information, and the wise man will read to his profit. Some of the most prominent Eastern manufacturers, always alert to seize possible advantages, have already established branches in this city (as our columns elsewhere will show), and if we mistake not, they will find their reward; but, this editorial is written as a suggestion to such as have not recognized the fact of themselves, that it will pay to locate a representative in Chicago. HECKEL.

THE PITIABLE SEQUEL TO A
GIGANTIC ENTERPRISE.

The progress of the trial of the dynamiters of the St. Louis street-railway strikes, has been watched with an interest in which contempt plays a prominent part. There is nothing surprising in the fact that one of these heroic incendiaries has turned state's evidence against his accomplices, for this is the usual outcome of such affairs. It is only cowards who would resort to such means, and when they are detected in their villainy, there is always a race and scramble among them to be first to "peach" and receive amnesty.

In the present case the defendants are George Withrow, W. P. Sears, M. W. Withers, Fred Pinkerton, David Keenan and Phil. Burnes. George Withrow, having turned state's evidence, has had the case against him dismissed, and is the principal witness for the prosecution. It is a pretty story he tells against himself and comrades, and is worthy of preservation. Here is the first installment:

"They were all members at the time, of the Cleveland Assembly, Knights of Labor, and when the difficulties between the railroad and the men failed to be adjusted by arbitration, Burnes, who is under 21, suggested dynamite as the proper argument to bring the companies to terms. He introduced Withers as a man who knew how to use the explosive, and the witness and Burnes cajoled Pinkerton, the Master Workman, and Keenan, the Treasurer, into indorsement of the movement. He said the money to buy the dynamite was furnished by the Executive Committee, which was composed exclusively of the defendants. The dynamite was purchased in Louisville by Withers, and after he returned a car was blown up every night for a week. The witness did not see any of them blown up and did not know who was doing the work, but had his suspicions. He said the intention of the conspirators was to damage the cars and frighten the passengers, so they would not travel on the cars. The entire assembly was expelled by the Knights of Labor and the dynamiters repudiated."

The logic displayed in this narration is about what might be expected from such a gang. Workmen were plentiful outside of the "Knights," therefore simple striking would not disable the company. Force proved futile on account of the police. But people don't like to ride over dynamite cartridges; therefore, dynamite was the thing with which to strike the enemy—to stab him in the back, as it were. Accordingly, these subtle, bold, and brilliant conspirators secured their dynamite and proceeded to enlist public sympathy in their behalf, *vi et armis*. But the cruel minions of an unsympathetic and hard-hearted law stepped in, and with relentless hand shattered the still unboiled glue that was to cement the bond between strikers and public.

And now this band of devoted heroes, who faltered not nor flinched in handling the deadly dynamite cartridges which were to settle finally and irrevocably the rights of the down-trodden and suffering "jaw-workers;" this little cabal of self-constituted martyrs, deserted of the public they so heroically tried to conciliate, forsaken of the order whose tool they made themselves, denouncing one another, and face to face with the Nemesis of the law, are indeed a sight of pity.

It has been said by one whose judgment seldom went astray, that

"'Tis sport to see the engineer
Hoist with his own petard."

But, in the present instance, the "sport" is all lost in the abject pitiableness of the sequel to an enterprise so gigantic.

When will workmen learn that two wrongs can never be added together, so as to produce one right? When will they learn that "jaw-workers" are the very poorest workmen the human race—which it must be admitted, has

GEORGE W. PAYNE, who has been making an experimental sojourn in Chicago for the last few months, has resumed his position as Eastern Manager of *The Industrial World*. While we are sorry to lose so thorough a gentleman as Bro. Payne from our local circles, we can not refrain from congratulating both him and the *Industrial World* on the resumption of the old relation.

ASSOCIATION REPORTS AND
PAPERS.

For several reasons we think it best not to print in our columns the various reports and other papers read before the American Street Railway Association, and we trust that our readers will agree with us, and recognize the wisdom of this decision. Our reasons are, first, all the members of the association have already heard them read; second, they are printed in full in the convention reports, which are scattered liberally among street railway men; and third, the technical press in general also aids in spreading them broadcast, so that every one interested will be likely to see them long before we, or any other single paper could publish them in full. On these grounds we are convinced that our subscribers will prefer to find in our columns new and original matter, such as will be not less useful or valuable than the papers in consideration, and is less readily obtainable elsewhere.

turned out some pretty mean specimens—can produce? When will they learn that their wiser advisers will not lead them into dangerous predicaments, and that their true friends do not abandon them when in trouble? To be a “workingman’s friend,” or a “social-labor reformer,” is, just now, a very paying business, and the workmen have to pay with one hand for supporting such in garrulous idleness, and with the other for the expensive mistakes they are constantly making. For many of us society is *not* comfortably organized, but dynamite will never improve it, nor will all the “chin-music” of all the demagogues in the world serve to set in tune again its disordered music. Evolution will finally bring all these matters right, while revolution and blab and dynamite can only serve to bring about a “confusion worse confounded.” HECKEL.

CAUSE AND EFFECT OF STRIKES.

The labor disturbances which become rife at certain periods throughout some sections of the country, present a difficult problem for solution, and many of the strikes and disturbances afford a most thorough confirmation of the truth of the old adage, “Idle hands some mischief still will ever find to do.” At the present time men have plenty of work and the willing worker will find fair compensation for his labor. Provisions, wearing apparel and house rent are cheap. Yet there are strikes, and one has just ended, as they all do, in a neighboring city. The mistakes frequently made in discussing the relations of capital and labor, and the false views of these relations entertained by many superficial observers and illogical reasoners upon the subject, arise, in a great measure, from a consideration of them under abnormal circumstances. The natural relations of capital and labor are co-dependent. The interest of neither can suffer without injury to the other, unless the normal and healthy condition of society has been disturbed by a force sufficient to destroy harmony and interest between them. Capitalists may individually regard labor, in some instances, as something to be got at the lowest possible price, without regard to the rights of the laborer. But such an opinion can be entertained only by a man of narrow and superficial views. Equally narrow and superficial is the view of the laborer who demands for his work all that he can get, without regard to the real value of his services. It must be borne in mind that the present organization of society recognizes the rights of individuals to the possession of property, if lawfully obtained. Such recognition implies the right of protection from lawless encroachments, and against loss, so far as personal management can avail to avoid losses. And further, the present organization of society forbids that any interference with the management of capital by its possessors, should be tolerated, so long as it is in every respect legal,

If these conditions are no longer tolerable, the only way to remedy them is to reorganize society from the bottom. But again, because labor suffers during the winter season for want of employment, is it fair to charge its privations to capital? To all intents and purposes, labor is a commodity which is amenable to the law of supply and demand, like any other. The world, as a whole, or this country by itself, has never seen the time when it had labor enough. If labor was properly distributed there would today be a greater demand than could be supplied.

The lessons of history, experience, and observation show that the combination of employes against employers and *vice versa*, is not beneficial to either. In standing aloof from these organizations and refusing to encourage them, we may possibly displease those who believe more in the strong right arm than in the power of the claims of simple justice properly presented. The despotism of capital is a favorite theme upon which to ring the changes on all public occasions; but the greater despotism of trades’ unions is often permitted to pass without comment. The result is that many men are not permitted to learn trades unless they make pledges. The consequence is there is a dearth of mechanics and a plethora of clerks. The moment we become despotic in one thing, we acquire a dangerous love of power, and soon carry things to excess. The right of everybody to strive to become rich by honest, intelligent and patient labor is wholly inalienable, and it was to establish this right beyond cavil, that the founders of the Republic meant by the Declaration of Independence. We remember an address of Peter Cooper before a trades’ union once, in which he spoke substantially as follows: “During a long life passed in active business, I have never, known any but evil consequences to all classes, and especially to the innocent, to result from strikes, lockouts and other forcible measures designed to interfere with the steady and regular march of productive industry; and I feel justifiable in an earnest appeal to both workmen and capitalists henceforth to regard each other as equals and friends, and not to expect to reform social evils by combinations designed to force either side into the acceptance of unpalatable terms by the stern logic of starvation and indiscriminate ruin.”

We do not deny the right of workmen to associate and form unions, but when they essay to restrict the rights of others to sell their labor, to place the poorest work on a level with the best, or to dictate as to the amount of work which shall be performed, we maintain such action to be both arbitrary and unjust, and that its tendency is only to defeat the cause which should be their aim and endeavor to promote, if conducted in a proper spirit. NOLAN.

Our next issue will contain a portrait of Mr. William C. Richardson, Pres. of the Atlantic ave. Ry., Brooklyn, N. Y.

BECAUSE!

Under the caption “More Street-car Lines Needed,” one of the great Chicago dailies publishes the following: “Why can’t we have street-cars to connect the West Side with the North Side? Nearly all large cities—even a great many small ones—have such connections for the accommodation of the public. There ought to be, for example, a street-car line running on Halsted street from West Randolph street north to North avenue, and thus connecting the West Side with the North Side. Another one on Chicago avenue from the West Side to the North Side, and another one on North avenue from Humboldt Park to Lincoln Park. In many respects we are far ahead of other large cities, but in street-car accommodations we are far behind the average towns. How long will we have to wait for these most needful improvements? How long will the public stand to be imposed upon by street-car monopolies? How long will we be obliged to take two street-car lines, spending double the amount of money and time, when half of it would be sufficient? Wake up, Chicagoans, and look to your own interests.”

Now: Street-car companies, like all other enterprises or businesses, are organized and operated for the purpose of making money; and if they are really the great and grinding monopolies they are accused of being, of course it follows that they must be “well fixed,” and have enough capital to carry on and extend their business, and like any other branch of trade, they are not only willing, but anxious to extend their lines in every direction, not alone where it will pay in the present, but wherever there is a chance of profit in the immediate future.

Provided: They can beg or buy the necessary franchises from those assemblies of public wisdom called city councils.

So then: If the extensions and connections in question are needed (and it would appear that at least some of them are), why are they not built? * * *

Because! The lessons taught by the street-car strike of last summer are yet fresh in the minds of capitalists, who have invested, or would invest money in this direction.

Because! At that time they saw a great interest for days at the mercy of a mob, while those whose duty it was to protect this interest stood idly by, or openly abetted a lawless element, bent on riot and destruction.

Because! Demagogues, foreign agitators, socialists and cranks are allowed, through the press and in public places, to vent their foul mouthings and incendiary ideas, without let or hindrance, at times when—of all others—moderation and deliberation are most needed.

Because! Even at this late day, those public officers, few and far between, who did their duty on that occasion, are marked men, and are followed and hounded by trades-unions of socialistic tendencies, until, as the press states,

were it not for their friends in the councils—not, mark you, on account of having acquitted themselves like men and having been foremost in restoring law and order, but on account of their friends in the councils—they would be discharged for having performed their sworn duty. And it is

Because! Of all these things which render not only the property of the street railway companies, but the private property, yes, more, the *lives* of their attachés unsafe, that in Chicago, whose phenomenal growth should cause lines of intramural transportation to spring up like “Jonah’s gourd,” in a single night, capital hesitates to seek investment in this direction. Well may it be said, “Wake up, Chicagoans, and look to your interests!” Next! MONROE.

EUROPEAN NOTIONS.

Those who have traveled in Europe know to what extent the management of intramural transit in London and Paris differs from that of American cities. In London each omnibus has a conductor, and he will not allow any one to ride when there is no seat to offer him. These vehicles, with their double rows of seats on top, are light and pleasant in their construction. They may be found in every part of the city. There are also “tramways.” For long distances the “underground” may be used. The construction and management of this road is very much like that of the steam surface railways of England. They have the same general appearance.

In Paris, they have the elevated circular railway, tramways and omnibuses. As in London, no one is allowed to ride except he is given a seat—with one exception: several are allowed to stand on the immense platforms of the omnibuses. “First come, first served,” is the rule. This is accomplished by establishment stations along the routes, where you may apply for a number, and if you have the lowest one, when the stage arrives you may take precedence over all who have followed you. As your number is called out you take your seat. In this way you often claim your rights over a hundred who may just have arrived from some place of amusement.

The American cities are growing so rapidly that it seems quite impossible to adopt this rule. You might start a new line every week in New York, and we believe that at certain hours of the day, the cars would be crowded. Of course the shape of the city has a great influence on this question of transit. Then, again, the establishment of a new line creates travel. This is particularly observed since the new Broadway line was started. Thousands of persons now ride who never thought of using the omnibuses. We are not quite positive what the effect would be if the American lines attempted to introduce the European rule that requires every line to give to each passenger a seat. The ordinary American wants no restraint placed upon

him. He does not want even to be restrained in his supposed right to crowd his neighbor, to puff cigar smoke in every one’s face, and to make himself generally and particularly, a nuisance. He seems to say: “Let me on this car; I can’t wait a moment; I must get home before my tea gets cold.” He then attempts to spend the time in smoking (sometimes chewing), reading the newspaper, eyeing a pretty shop girl on opposite seat, telling the driver of some remarkable personal encounter he has had, giving the conductor some advice as to his duties, putting out his feet until some falls over them and delivering a lecture on the centralization of government in the street railways of the country. In the mean time he has passed his street. He now takes the number of the conductor, in order to have him discharged for inattention to his duties. But this individual whom we have sketched is the exception to the rule, and the city railroads, if they could afford it, should make use of an extreme application of the European rule in his case, and give him a car to himself. LOCKWOOD.

AN ARGUMENT.

Charles P. Shaw, Esq., has recently made an extraordinary argument before the Commissioners of the Supreme Court, of the State of New York, in which he advocates the construction of cable railways. All the burning issues of the world have been eloquently expressed by the great orators of their respective epochs. The friends of the cable railway, who are at the same time admirers of brilliant rhetoric, will congratulate themselves upon the fact that Mr. Shaw has been retained. He states that the “imperial theme” that embraces the question of “furnishing means of communication within the metropolis where the ganglia of human life and thought, and enterprise are clustered,” deserves at his hands a “swelling prologue.” When an orator, who possesses even so much ability as Mr. Shaw, excites his “nerve cells” and swells his “ganglia” to meet the requirements of a “prologue,” there is great danger of something bursting. As we read these high-sounding pieces of imagery it was quite certain to our mind that an unusual result was close at hand. The orator soon indulged in rhapsodies about the “symphony of locomotion;” denounced the “noise incident to the lumbering, vibratory energy of the locomotive;” and ended his sentence by a terrible outburst of indignation against the “*faculent* voidings incident to the use of animal power.” Even an orator, when he over-excites his “ganglia” must have relief. In this instance it resulted in one of the “incidents” attending the presence of animal life. Mr. Shaw did not want his hearers to be mistaken as to his meaning, so he used the “diphthongal” form of the word.

But a man, if we may call a person of the poetical nature of Mr. Shaw a *real*

man, could not long occupy his time in avoiding the “voidings incident to the use of animal life,” so he took aerial flight and sat upon a sunbeam “that melted frozen water on the pinnacles of the Alps. It was a small effort of the sunbeams upon each Alpine crystal of frozen-woven water; but crystal after crystal of the icy diamonds melted and united their products into the cataract that leaped from their mountain home; now in cascade, now in torrent, and finally reached the glowing Lombard champaign, on whose smiling bosom flow the Po and the Tiber. Thus, from a sunbeam kissing his frosty mistress of the ice, came the majestic river, whose yellow tide made the majesty of Rome and lent buoyancy to the boat that bore Cæsar and his sceptre of universal empire.”

We are reluctantly compelled to find fault with the necessity of using this most beautiful simile, and to regret that Mr. Shaw had to take such a useless journey to the pinnacles of the Alps, when he could have found the “sunbeam kissing his frosty mistress” anywhere along upper Broadway, on an afternoon of a January thaw, and even seen those “*faculent* voidings” swept away by the action of a “yellow tide” along the gutters of that magnificent thoroughfare. How beautiful and kind it is in the orator to make use of his mental conceits to locate in mythical Rome the scenes of kissing cold and frosty mistresses; of flowing yellow tides; of conquering Cæsars, whose chariots are cable cars.

With a cable road, Mr. Shaw thinks that Gothamites will be able “to conceive how the grasp of the iron, but flexible fingers of a metallic hand, can work the chords of the harp of human progress in this matter of intramural transit, as perfectly as Orpheus could have done it.” He evidently thought of a harp of a thousand strings, for he advocated that the cable should be put down in almost all the streets of the city. What a harmonious settlement of the question.

But at last premises and deductions get terribly mixed, and an awful doubt enters the mind of the orator as to the very question of whether there is “corporate” power granted to the Commission. “A corporation,” Mr. Shaw exclaims, “which is an artificial person, can not vocally say, ‘*I am!*’ A living, actual natural person can say, ‘*I am!*—I know I exist; and all the philosophy of all ages can’t dispute that.” But at last the strain upon the ganglion is too much, and the final intellectual voiding is that “it is almost a metaphysical question whether a fellow finds whether he is himself or another fellow; whether he exists, or whether he don’t exist.”

WISDOM CRIETH ALOUD.

When business is dull increase rather than diminish your advertising. No wise man will kick away the dam when the river is low.

MR. PECK AND MR. RICHARDSON.

Labor Commissioner Peck, of New York, seems, from the evidence so far published, to have been playing the part of Aesop's "Mountain," and, after a great deal of groaning, calculated to stir the fountains of sympathy to their very sources, has brought forth the very smallest sort of a white mouse. When we read Mr. Richardson's testimony side by side with Mr. Peck's deductions and arraignment, we are forcibly reminded of the ancient saw commenting on the discrepancy between the relative quantities of noise and hair procured in shaving a pig. We can see nothing in Mr. Richardson's testimony evincing cruelty or oppression of any sort whatsoever, and while the work of a street car driver or conductor is not the *most* pleasant or lucrative to be had, there are always plenty seeking such positions, and they are by no means the *least* pleasant or lucrative jobs to be found. Mr. Richardson has always appeared to us, a man who would be pleased to give his employes a chance to prove themselves deserving, and alert to recognize and reward such desert. But whatever may be the real merits of the case under discussion, Mr. Richardson has had more than twenty years' experience as a street railway superintendent and president, and if he has not learned by this time how to conduct his business with the greatest satisfaction and profit to all concerned, we doubt whether Mr. Peck shall be able to teach him anything new in that connection.

HECKEL.

PERSONALS.

DANIEL A. JONES.

Daniel A. Jones, who has been for the past five years a director and large stockholder in the City Railway Company of Chicago, recently died at his residence in Chicago, in his seventy-ninth year. Mr. Jones was one of the most public spirited among Chicago's wealthy business men, and almost every enterprise of merit in the city has at some time had his assistance in one form or another. He was born in Hartford, Connecticut, though losing his father at a very early age, he went to Williamstown and lived up to his eighteenth year with his grandfather, Israel Jones, a man of sterling character and broad intellect, whose precepts and influence followed the younger Mr. Jones through his long life.

At seventeen years of age he removed to Louisville, Ky., and after several other changes of location, came to Chicago in the fall of 1859. From that date his name appears on every page of Chicago's history. He was for fourteen years president of the Chamber of Commerce, five years president of the Old People's Home, and director of the city railway, and was also a director of the Merchants' National Bank and the National Bank of America. He held one of the original membership tickets

of the Board of Trade, which cost him \$5,000, and which would sell for thousands to-day. Besides real estate of great value, he left personal property valued at \$1,073,315.16, including 1,700 shares Chicago City Railway Company—\$170,000—and ten construction bonds of the same company, worth \$1,000, each.

Mr. Jones leaves a reputation for wide culture, sterling integrity, profuse liberality and open-hearted generosity, but the latter of an especially careful and discriminating sort; and his clear judgment of human character and motives seldom led him into error. He was universally respected, admired and honored.

ROBERT G. MATTERN.

Mr. Robert G. Mattern is now located in Chicago as the representative of Andrews and Clooney, of New York. Mr. Mattern has his headquarters in Lake-side Building, and is rapidly making friends for himself and the firm he represents.

HALL-DUNN.

ROCK ISLAND, Ill., Feb. 3.—[Special]—Clifford F. Hall, editor of *The Modern Miller*, of Moline, and Miss Jennie R. Dunn, were united in marriage this morning.

It gives us great satisfaction to record this event, and to know that our old friend Hall has at last learned that "It is not good for man to be alone." That was about the only truth his comprehensive intellect seemed unable to grasp. Possibly it was because he loved "Liberty" too well; but we trust he will now learn that there is a thralldom dearer than liberty, and that his many friends may have an opportunity to conclude from experience that the hospitalities of Benedict Hall surpass even those of "Liberty" Hall, famous in the annals of Moline and dear to the memories of all the "old boys."

OBITUARY.

The Higley Car Journal Company, of Cleveland, Ohio, have met with a serious loss in the death of their president, Mr. A. M. Burke, who died January 27, '86. Mr. Burke has only been connected with the Higley Company for about two years, but was a well-known business man of Cleveland, and leaves a host of friends who will deeply mourn his loss. He will probably be succeeded as president of the Higley Company by Mr. S. M. Carpenter. E. V. C.

POINTERS.

CONNECTICUT.

New London.

The residents are said to be displeased with the prospect of a horse-railroad, to be built between that city and the Pequot colony. An outside company has stolen a march on the local citizens interested, and got a charter for such a railroad before the Legislature.

Meriden.

An application is before the Legislature for a new street railroad charter.

New Britain.

There is an application for a street railroad charter, pending before the Legislature.

ILLINOIS.

Chicago.

The directors of the West Division Street Railway Co., on the 15th ult., elected the following officers: President, J. Russell Jones; vice-president, E. H. Campbell; secretary and treasurer, George L. Webb; superintendent, De Witt C. Cregier.

The South Side company, whose cable lines are running in sharp competition with the Illinois Central Rd.'s local service, claims to be very close to a solution of the heating question.

The North Chicago City Railway Co. held its annual meeting on the 8th inst. The entire Board of Directors and all the officers were re-elected.

The Chicago Passenger Railway Company has been given the right by the city council to lay tracks, starting from the corner of Ashland and North avenues, on Ashland avenue to Erie street, on Erie to Center avenue, on Center avenue to Austin avenue (old Hulbard street), on Austin avenue to Desplaines, and on Desplaines to Adams street, with a spur on Washington street from Desplaines to Michigan avenue, an extension on Michigan avenue to Adams street, and a cross line on Franklin street from Adams to Washington. This company's new lines will zigzag between the lines now operated by the old West Division Company, crossing the latter's tracks nine times—at Clinton and Washington streets, at Randolph and Desplaines, Lake and Desplaines, Milwaukee avenue and Desplaines, Milwaukee and Austin avenues, Austin avenue and Halsted street, Center avenue and Indiana street, Ashland and Chicago avenues, and at Ashland and Milwaukee avenues. Their Austin avenue route, as projected, parallels the West Division Company's Indiana street line, running from Center avenue to Halsted street.

In addition to acquiring this new territory, the Passenger Railway Company has availed itself of the only way of keeping up an unbroken connection with the South Division—the Washington street tunnel. The advantage of the Franklin street and Michigan avenue rights, lies in the fact that the company will be able to circle round by way of Washington street, Michigan avenue, Adams and Franklin streets, removing the pressure on the business streets by running the cars around a block instead of stopping and turning on one street, blocking the traffic.

The company will not begin to build its lines until the frost is out of the ground, but, when it does begin, will push on very rapidly. The company has not yet decided how to utilize the tunnel. It is not possible to use horse power, for, while there is no trouble in getting down, the grade is too steep for horses to pull a loaded car up, and the chances are when the company comes to run its cars through the tunnel some modification of the cable will be employed.

The mayor recently signed an ordinance granting to the Chicago Passenger Railway Company permission to lay tracks on Harrison street, between Desplains and State street. It requires the company to pay half the expense of building a double-tracked bridge over the river, and to contribute to its maintenance. The company is allowed five years in which to make the payments.

The Chicago Passenger Railway Co. has received its sample Honigman motor from Germany, and trial trips recently made on the line satisfied those interested of its eminent applicability to the service demanded.

The Chicago City Railway Co. has placed protection guards over the wheels of the engines and cars of its Cottage Grove ave. dummy line. Other improvements looking to the safety of the public are promised.

The North Chicago City Railway Co. has asked of councils permission to lay tracks on Market street, from the intersection of its tracks on Chicago avenue to Michigan street, thence along Michigan street to Wells street. Referred to committee on railroads.

An ordinance was introduced in councils to compel the West Division Railway Co. to run at least one car on Twelfth street, between Clinton street and Ogden avenue, once in every five minutes between the hours of 6 and 11 o'clock A. M. and between 12 and 1 and 5 and 7 o'clock P. M., under a penalty of \$10 for each failure. It was referred to the committee on railroads.

Ald. Colvin introduced an ordinance authorizing the North Chicago Railway Co. to construct tracks from Clybourn avenue to the river on Halsted street, and the West Division company from the river to West Indiana street; transfer tickets must be given by either company, so that passengers can ride from Lake View to the stock yards for one fare. He also introduced an ordinance giving the North Side company the right to build a road on Market street, from Chicago avenue to Michigan street, with single-track connections with Wells street on Illinois and Michigan streets.

An ordinance was introduced granting the Star Horse-railway Company rights of way on sixteen miles of streets. The company was incorporated last June by J. W. Lanehart, C. J. Ford, and Robert Elder. The first two are young lawyers, the latter a real-estate man. Stephen G. Clarke, of Lake View, is its chief promoter. Mr. Clarke is a retired contractor of means, who is said to have built more miles of railroad than any other man in the country. Mr. Clarke, it is said, has the financial assistance of a number of capitalists in his undertaking, and as soon as the ordinance is passed they will furnish the funds to lay the track and equip the road. The company claims to have ample funds to pay all construction cost

and keep the road running for five years without making expenses.

The attorney for the road says that petitions representing a majority of the property-owners along the lines, except that on Dearborn street, have been obtained. The lower part of Dearborn street favors the road, and the work of securing the signatures of the property-owners toward Washington street is promising well. The company had some trouble in obtaining the necessary signatures along Taylor and 14th streets. They will contribute toward the building of a bridge at Taylor street. When a right of way into the business portion of the city is secured, the company will be ready to begin the work of construction.

The route chosen begins at Washington street on Dearborn, and extends to Polk, through which it runs to 4th avenue and thence south to Taylor street. The line on Taylor street runs to Western avenue. Another line leaves Taylor street at Desplains street and runs to 12th, thence to Union, and down that street to 22d, connecting at that point with a proposed line on 22d street from State street to Trumbull avenue. A third line on 14th street extends from Union street to Western avenue. Other lines will run on 19th street to Western avenue to California avenue, and on Western avenue to 22d street.

On the 29th ult. the *Times* published the fact that a delegation from the Street-car Conductors' and Drivers' association had called upon Mayor Harrison and requested him to give employment to McCarthy, one of the men who figured conspicuously in the late strike. One of the delegation, Mr. Kleckner, stated that the last official act of Mr. J. K. Lake, as Superintendent of the West Division Railway Company, was to "remove Mr. McCarthy, whom he had never forgiven, notwithstanding the fact that all the discharged men had been reinstated." It was further stated that Mr. Coyne, who was the other man of the delegation, "was also one of the men discharged prior to the strike by Supt. Lake." A reporter for the *Times* learned yesterday from an official source that Mr. McCarthy was not discharged by Supt. Lake, but by President Jones, of the company. The facts in the case were as follows: During the early part of January, McCarthy's record was submitted to President Jones, who, after a day's consideration, told McCarthy that he could have until the 14th of January to straighten out some matters in his record, and that then his resignation as conductor would be expected. This course was given in preference to a discharge, and an order for him to go to work in the interval was issued by order of Mr. Jones. The *Times* informant states also that McCarthy did not go to work, but came around after the 14th, and requested another order. This application was submitted to Mr. Jones, who refused to grant it, saying that McCarthy had been discharged. The *Times*

is also informed that Mr. Coyne was never discharged from the service of the company, but has been posing as a martyr ever since before the strike, conveying the impression that he had been discharged. The mayor expressed his regret that "Mr. Lake had discharged Mr. McCarthy," and advised President Jones to reinstate him. From the above facts it appears that it is very doubtful if Mr. Jones takes the advice.—*Chicago Times*.

The National Motor Company has been incorporated, with a capital stock of \$250,000; incorporators, Edward Koch, Edward Bartholmae, and Ernst Lehman; to manufacture street-railway motors.

* *

INDIANA.

Elkhart.

The Elkhart Street-railroad Company has been incorporated. Capital stock, \$50,000. Directors: John Lyons, Edmund Hersterter, Julius Woods, Jeremiah H. Knight and Isaac Nodel. Lyons and Knight, each hold 230 of the five hundred shares of stock.

* *

KENTUCKY.

Paris.

It is reported by the *Tradesman*, that a street railway is wanted in that town, and that Mr. J. G. Craddock can give particulars.

* *

MASSACHUSETTS.

Boston.

There has been incorporated here the Massachusetts Cable Construction Company, capital stock, \$100,000. Incorporators: Chas. L. James, president; S. Lawrence French, treasurer; Wm. E. Russell, Peter A. B. Widener, Wm. L. Elkins. Object: Constructing and furnishing all necessary materials for constructing and equipping cable street railway systems; to acquire and hold any patents connected with said systems.

A street railway operated by cables is to be built in Boston if the aldermen will allow it. Such a company has been organized and the general plan is to build a road to Brookline, from there to Cambridge and thence back to Boston.

In the lower house of the state legislature, on the 26th ult., the Highland Street Railway Company, by Moody Merrill, president, presented the following petition:

"The Highland Street Railway Company, in view of the crowded condition of the streets of the city of Boston, and in view of the fact that under the present system of allowing several street railway companies to run cars in said streets, more cars are required than would be necessary if there were only one or two such corporations, and in view of the growing belief that something must be done to prevent, as far as possible, the occurrence of horse-car

blockades in said streets, petitions that it may be authorized to lease or purchase the franchise and property of any and all other street railway companies which are authorized to run cars in and into said city of Boston and that all such other street railway companies may be authorized to lease and sell their franchises and property to your petitioner and that your petitioner may unite and consolidate with any or all of such other street railway companies, and that said united companies may constitute one corporation. Also that authority may be given to your petitioners and also to such consolidated corporation, if there shall be any such, to make such underground and surface alterations of the streets in which their tracks are now, or may be hereafter laid, as may be necessary to establish and maintain the cable system of motive power, so called, under the same provisions of law as now exist for the location and maintenance of tracks. Also that your petitioner may be authorized to increase its capital stock so far as may be necessary to carry the above into effect."

East Cambridge.

The secretary of state has given out articles incorporating the Meigs elevated railroad construction company, now building in Cambridge. The capital stock is fixed at \$100,000, divided into 1,000 shares of \$100, and the names of the incorporators are as follows: Benjamin F. Butler, William S. Butler, W. W. Kimball, Irving A. Adams, John P. Squire & Co., S. C. Hurd, Roswell C. Downer, Henry A. Millis, Frederick A. Squires, W. P. Lane, Frank E. Squire, Walter L. Hill, R. B. Brigham, and A. C. Drinkwater.

North Adams.

"The people here are working energetically to get matters in shape to push the street railway (already reported) to an early completion in the spring. An extensive profile and map of the route has been made by the surveyors, and taken to Boston for the use of the committee at their hearings before the legislature.

The horse-railroad people have filed their petition in Adams, and the hearing before the selectmen of that town comes February 13. The petition in North Adams will be filed as soon as the preliminaries as to crossing the state road are settled.—*Ex.*

Springfield.

At the stockholders' meeting of the street railway company all the old directors were re-chosen as follows:

John Omsted, George M. Atwater, C. L. Covell, James Kirkham and Gideon Wells. They also listened to the treasurer's and the directors' reports, made public about two months ago.

Fitchburg.

The "Fitchburg Street Railway Company" asks to be incorporated. Its capital will be \$60,000 and its lines of railway three miles in extent through the

heart of the city. Of the 600 shares, 581 have been taken by Boston and Newton parties.

Fall River.

Seelye Bros., of New York, who own the Worcester street railway, are seeking to lay tracks in Fall River.

Holyoke.

The stockholders of the street railway company at their annual meeting elected the following directors: W. A. Chase, G. E. Dudley, F. P. Goodall, S. G. Gaylord, W. S. Loomis, C. B. Prescott, J. A. Sullivan, G. H. Smith, Hiram Smith. The directors organized with W. A. Chase as president; W. H. Brooks, clerk; C. Fayette Smith, treasurer; G. H. Smith and C. B. Prescott, auditors. The matter of extending the tracks was discussed, but definite action was deferred till the next special meeting.

Pittsfield.

Pittsfield is struggling with the question of introducing a street railway. A petition has been presented and a hearing had in reference to the location. The location as set forth in the petition was from the depot, up West Street to North street, to Waconah street, and from there to Pontoosuc lake. It also included a road on Fenn street. There is the usual opposition manifested, based on fears of "stock-jobbing," spoiling streets, etc., etc., but as the more progressive of the inhabitants, who happen in this case to be the largest property-owners, favor the scheme, it will probably be realized at an early day.

* *

MICHIGAN.

Detroit.

The Detroit City Railway will replace, with a large number of sixteen-foot cars, the twelve-foot fare-box cars now in use. The construction of several new lines in the spring is contemplated.

* *

MISSOURI.

St. Louis.

The Missouri Railway Co. is constructing new brick stables, which will accommodate 275 horses and 225 cars. Towards spring the track lying between Twelfth and Eighteenth streets on Chestnut street, and on Market street from Ninth to Eighteenth streets, will be entirely reconstructed. This is necessitated by the repairing of these streets with granite.

Kansas City.

The City Council now has under consideration the passage of six cable street railway ordinances. The lines are known as the Fifth, Twelfth, Fifteenth, Troost, Westport, and Rosedale lines.

* *

NEW HAMPSHIRE.

Nashua.

The Nashua Horse Railroad Company has voted to build in the Spring, and has appointed a committee to purchase supplies.

NEW YORK.

Brooklyn.

The newly-elected directors of the Brooklyn City road have chosen William H. Hazzard, president, and W. M. Thomas, vice-president. The executive committee includes Seymour L. Husted, James How and Frank Lyman; and the examining committee, Wm. Husted, Crowell Hadden and Edwin Parkard. The only change over last year is in replacing Mr. Thomas by Mr. Lyman.

The following corporations of Brooklyn and vicinity have paid their annual tax quota into the state treasury:

Grand Street and Newtown R. R. Co., \$242.25; Brooklyn Crosstown R. R. Co., \$500; Brooklyn City & Newtown R. R. Co., \$450; Brooklyn City R. R. Co., \$7,000; Atlantic Ave. R. R. Co., \$1,400; Broadway R. R. Co., of Brooklyn, \$1,225.

The report of the Brooklyn City and Newtown railroad shows a surplus of \$44,867.00. The gross earnings from operation amounted to \$68,611.39, and the expenses of operation to \$62,795.82. The assets of the company are \$1,712,111.24, and the liabilities, \$1,707,624.54.

The Grand street and Newtown and the Brooklyn, Bushwick and Queens County lines have filed their quarterly reports for the quarter ending December 31, 1885, with the board of railroad commissioners at Albany. The statement of the Bushwick road shows the following:

Gross earnings from operation, \$9,917.50; operating expenses (excluding all taxes), \$13,714.66; net loss from operation, \$3,797.16; income from other sources than operation, \$11, leaving a deficiency of \$3,786.16. The report of the Grand Street railroad shows the gross earnings from operation to have amounted to \$33,268.75; operating expenses (excluding taxes), \$29,741.23; net earnings from operation, \$3,527.52, and the income from other sources than operation, \$608.67. The gross income from all sources is placed at \$4,136.19, and the net income from the same at \$326.31.

The report of the Crosstown railroad, filed at Albany, shows the gross earnings for the last quarter of 1885 to have been \$74,073.94, and the net earnings, \$29,109.60.

The gross earnings of the Brooklyn City railroad were \$56,622.09; net earnings, \$116,861.81.

The Brooklyn City Railroad Company, which has eleven lines of street-cars, recently informed the conductors and drivers in its employ that after February 14 a day's work will be considered twelve hours, and the pay for it will be \$2, and overtime will be paid for at the same rate. The men will be paid by the trip as heretofore, but where they work more than twelve hours they will receive more pay than formerly. The average time

for the conductors now is thirteen hours and a quarter, and if they work as much after the new order goes in force they will earn about twenty cents a day more. The change will cost the company from \$50,000 to \$75,000 a year. President Hazzard said that the change had been made by the unanimous vote of the directors of the company.

It is expected that the other street railroad companies in Brooklyn will also reduce the time of a day's work to twelve hours.

The Drivers and Conductors Association of the Southern Division of the Brooklyn City railroad have adopted the following resolutions:

Whereas, The board of directors of the Brooklyn City railroad having reduced the hours of labor and increased the pay of its employes:

Resolved, That we, the conductors and drivers of the Southern Division, heartily thank the board of directors for this act of justice to the men who have in their daily labors the watchfulness and safety of life and property, and believing that the interests of the employers and employes are always identical, which fact the directors of the Brooklyn City railroad have hereby recognized.

| | | |
|--|---|------|
| EDWARD CLEAR, JAMES E. THORNTON, PATRICK FARRELL, HENRY F. CLEAR, PATRICK HOGAN. | } | Com. |
|--|---|------|

A new line has been opened, running from Pacific street, at Ralph avenue, across Atlantic avenue and Fulton street to Broadway, and along that thoroughfare to the ferries. The road is the property of the Broadway Railway Company, and was built to accommodate the residents of Ralph avenue and adjacent streets. Brick stables have been erected at the corner of Ralph avenue and Pacific street, where 200 horses and twenty cars are now housed. During the rush hours the cars run under five minutes headway. The trip from the stables to the ferry and return consumes sixty minutes.

The Brooklyn Rapid Transit Commission has formulated a plan under which the trunk line elevated railroad company between the city hall, the bridge and Fulton Ferry may be incorporated. The general plan of the proposed line is that of a double-track elevated railway, each track being supported by two longitudinal girders placed over the carriage-ways of the streets; these girders are in turn supported by transverse girders, the ends of which rest upon vertical columns, which will be placed as near the curb as possible without interfering with the passage of vehicles. There are to be four stations—one each on the east and west sides of Fulton street, near the City Hall, and extending toward the court house; a down and an up station at Tillary and Fulton streets on private property to be taken for each; and terminal stations at the ferry and

the bridge. Four stations will also be built on the Adams street route—one at Tillary street, another at the Bridge, a third at Water and Main streets, and the terminal station at the ferry. The entire work must be finished within five years. From 4 a. m. until midnight the fare will be five cents; during the other four hours ten cents will be charged. The capital stock is to be \$1,000,000, divided into \$100 shares, with the right to increase the capital stock. Each subscriber is to pay 5 per cent. of the amount of the subscription at the time of taking it.

Directors of the Brooklyn Elevated Railroad Company claim that unless the road can charge seven cents fare instead of five it will have to go into bankruptcy. The present fare of five cents is not paying the running expenses of the road. But if the Brooklyn road is put into the hands of a receiver it will, it is claimed, stop the building of other elevated roads for ten years to come.

Mr. William C. Richardson and the executive committee of the Dry Dock Railroad Company, of New York, recently visited Cleveland to inspect the cable system there.

An overheated stove in the car-stables of the Seventh-Avenue railroad, Twentieth street, near Seventh avenue, set fire to and destroyed the building on the 4th inst. The building was a one-story frame and stone structure. The loss is estimated at \$10,000, covered by insurance. In the stable were two snow-plows, one sweeper, and 16 new cars, which were consumed. The loss on them, about \$13,000, is also covered by insurance. The building and stock was owned by the Atlantic-Avenue railroad company.

Mr. E. B. Litchfield, the purchaser of Gunther's railroad, is attempting to gain the right of way for a new road to be built on Fifth avenue, and for one to be built on Fourth avenue. The company which Mr. Litchfield heads has a charter giving it the right to build an elevated railroad on Fifth avenue, provided it gets the consents of owners of property to the extent of one-half the valuation of the whole street, and also the consent of the city authorities. The consents of property-owners to an extent considerably beyond half the valuation, so it is claimed, are now in the hands of Assistant Corporation Counsel Mudge, receiving examination. There is also a bill before the legislature at Albany asking leave to extend the Brooklyn, Bath and West End railroad on Fourth avenue from Fulton street to Flatbush avenue, also belonging to Mr. Litchfield.

The snag which the Fifth avenue elevated project has struck is the Church of St. Augustine, situated on the corner of Bergen street and Fifth avenue. Its congregation are most emphatically opposed to the trains of an elevated rail-

way going past their church and interrupting the services.

But all the residents of the district far out toward the city line want the railroad, and the only real obstacle seems to be the church and its congregation.

Mr. Charles A. Cheever, who is largely interested in Rockaway real estate, and who is bent upon its improvement, is circulating a petition among the villagers to obtain consents for the construction of a horse railroad from the Long Island Railway depot, at Far Rockaway, to the sea. The total length will be a little over a mile. The new enterprise is largely approved in the town, as under present conditions all landlords have to run free carriages to the trains, and do not get enough out to make up deficiencies. It is Mr. Cheever's intention to charge but five cents fare and to build and operate a first-class line.

New York City.

Some of the local papers are calling for an elevated railroad connecting the Bridge with the Sixth-ave. line, running through Center and Chambers streets. Such a road, it is claimed, would not only be a great accommodation to Brooklyn people going uptown, the principal drygoods stores, hotels and places of amusement being on the west side and difficult of access from the Third Avenue Railroad, but would also accommodate the large number of passengers on Sixth av. who wish to reach the court house and the city hall. There should be a station at Broadway, and of course direct connection should be made.

The franchise of the Broadway road calls for 3 per cent. of the gross receipts on all passengers riding on the cars below Fourteenth street. The city comptroller's report says: "The system pursued for computing these passengers is based upon the 'conductor's tally slip.' On arriving at Fifteenth street on the down trip the conductor notes the number of passengers recorded by the register and places it in column 3 of his slip. He then counts the number of passengers in the car at that time and records it on his slip in column 4. The difference between these numbers shows the number of passengers who have left the car up to that point. On arriving at the battery he records on his slip the number shown by the register in column 5. The difference between this last number and the number who had left the car before arriving at Fifteenth street gives the whole number who have traveled down Broadway on that trip.

"On the up trip the register is examined by the conductor at Fifteenth street, and the number recorded by it is noted in the tally slip in column 6. Each of these tally-slips records the number of passengers carried by the cars under one conductor during one day. On the completion of his day's work, this tally-slip is signed by the conductor and handed in at the office. It

is then added up, or verified, and then recorded in a book kept for the purpose, this book having the same subdivisions as the tally-slip. All the tally-slips being in for the day and recorded in the book, the columns for that day are added up and the necessary calculations made."

"I am satisfied," said the comptroller, "that this company is acting as squarely by the city as can consistently be expected. They paid \$9,000 the first quarter, and will pay at the expiration of the year \$40,000 as a tax."

The hours of the car drivers on Sixth and Eighth avenues have been reduced to twelve hours a day. They have been fourteen. The men are to get the same pay as before—\$2—and make one trip less. The conductors also benefit by the change.

One of Cyrus W. Field's representatives has made the following statement public in regard to the Manhattan Elevated rights in Westchester and other extensions: "It is intended to build the Westchester extension without delay, all parties in interest being agreed as to the manner. It is also intended to build a branch from Grand-street Ferry to Second-avenue elevated and charge five cents thereon. Another connection will be from the battery along West street, past Canal street, to a connection with the Sixth avenue and Ninth avenue lines, and have stations at the intermediate Ferries. It is supposed that the cost of these improvements will reach \$5,000,000."

Dr. Morris, of the Health Board, has recommended the exclusion of straw from the street cars. The Broadway road people say it costs them \$60.00 per day for straw, and that no unclean straw is used. Nevertheless, the company proposes to substitute for the straw, wooden slats, which will be placed in the cars as fast as they can be manufactured.

The Dry Dock, East Broadway and Battery road report, gross earnings, \$219,061.46; net earnings, \$89,809.90.

An extensive street-car strike was inaugurated at 4 o'clock A. M., Feb. 4th. By order of the Knights of Labor, the 6th avenue, the 4th avenue, and 7th avenue lines were unable to run their cars, while but one or two cars were run on the Broadway line. There were about seventeen hundred and fifty men in the strike, including drivers, conductors, hostlers, and hitchers.

Six hundred drivers and conductors and 200 stablemen and hitchers employed by the Broadway and Seventh Avenue railroad company quit work at midnight. The stablemen asked for no concessions from the company, their only reason for going on a strike being that an agreement with the drivers and conductors had not been carried out.

The board of directors held a short session, at which Superintendent Newell laid before them the demands of the

men. They voted to concede to these demands.

The directors of the Sixth Avenue line also acceded to the demands of the strikers.

The Fourth avenue line also acceded, and the cars were all running on the same day.

The demands were that twelve hours should constitute a day's work. The Second and Third avenue roads adopted this limit several weeks before, and the Broadway and Eighth Avenue companies followed their example. Later President Hayes, of the Eighth avenue road, issued an order making the requisite number of trips on the Vesey street division six instead of seven, and took off half a trip on the Harlem division. At the same time he voluntarily added 10 cents to the daily earnings of the men on the latter division, making the uniform pay of drivers and conductors on that road \$2 per day.

The stages of the new Fifth Avenue Transportation Company are now running on Fifth avenue. It was the intention of the directors of the new company to postpone the opening of the line until the completion of the new stages, in April; but the repeated efforts to secure the avenue for a horse-car line induced them to forestall all attempts looking to that result by buying stages from the defunct stage lines, and beginning operations at once.

Eleventh street is the present terminus of the route. A petition is now before the Board of Aldermen asking for an extension of the route, and if it is granted the stages will start from Bleeker street at South Fifth avenue, along that thoroughfare to Fifth avenue and thence to Eighty-ninth street. Fifteen stages are now in use. They are painted white, with the words "Temporary Stages" above the windows on the side, and beneath them the words "Fifth avenue." They are comfortably upholstered, and will accommodate twelve persons easily. They are drawn by Norman horses, none of which are less than fifteen hands high. The stages are some of the old Fifth avenue, Twenty-third street and Madison avenue omnibuses.

The new stages, the first installment of which will be ready for use in April, will have a body lower than those now in use. They will accommodate twelve persons inside and five outside, and during the winter, when snow is on the ground, the wheels are to be replaced by runners. Each stage will have a conductor. The stages will run Sunday during the same hours as on other days.

**

OHIO.

Cleveland.

Work on the double tracking of the Brooklyn street railroad through Brooklyn village commenced a short time ago, but will not be pushed to completion before spring. It is proposed to lay a double track, with the Johnson Girder

Rail, 52-lb., from the city limits to Brooklyn Center, a distance of a little over a mile.

Pursuant to his avowed policy of leaving no stone unturned to accommodate the public, Mr. Johnson is experimenting with a car heater, recently patented by Cleveland parties. The scheme is novel, though based upon the "dry air" principle. A small coal-oil stove is placed in the center of the car, under the floor, being fed from a reservoir placed above one of the windows, all smoke emanating from the combustion of the oil being carried off through a tin flue running through the top of the car. The patentees claim that the stove will consume about three gallons every eighteen hours, and that cars can be heated for less than twenty-five cents per car per diem.

Toledo.

The Consolidated Street Railway Company will, as soon as weather permits, proceed to widen the Monroe street line from its present gauge, three feet six inches, to standard gauge, and will increase the number of cars. The termini of that line will be at the Pennsylvania depot and Wagon Works.

The Central Passenger Railway contemplates some important changes in the running gear of its cars. Five new cars received recently from the Brownell & Wight Co. are equipped with the Roff-Emery axle brake.

**

PENNSYLVANIA.

Philadelphia.

At another place we publish an account of the recent sale of the People's Co.'s lines to a syndicate of Lombard and South Street men. The People's Company owns extensive and valuable franchises, running from Dickinson street on the south, to Germantown on the north, and from the Centennial grounds on the west, to the Delaware river, on the east. Mr. Harrah's excellent management as president of the company since 1882, has lifted its properties from almost hopeless wreck to an excellent paying basis. Following is a local notice of the last annual report:

"The annual report of the People's Passenger Railway Company shows the affairs of that corporation to be in a condition which must give satisfaction to its stockholders. Over 22,000,000 passengers were carried last year, and after meeting all operating expenses, including leases, charges and interest, there is a balance of \$14,107.32 from the receipts. President Harrah deserves great credit for the skillful manner in which he has managed the affairs of the company."

The business of carrying the people of Philadelphia about the city is rapidly drifting into the hands of two great combinations of capital. If the rival syndicates remain rivals, it is possible that the people may be carried about more

cheaply in the future than in the past, and so far the absorption of separate railways will be a benefit. The charter franchises possessed by the rival to the Traction Company are certainly valuable, and will become more so as the city grows southward and westward. The right to run tracks through the park is a surprising revelation, and its exercise ought not to be permitted in any way which will mar the beauty of the city's breathing place. Only seven street-car companies are now left in independence, and this number is likely soon to be reduced. The next six months will probably see important changes in the whole street-car system.—*Phila. Press.*

There has been a good deal of comment upon the expression of one of the magnates of the city railroads that he would "rather own a five-cent road in New York than a seven-cent road in Philadelphia." That was in reply to the demand for five-cent fares. He said that in the morning and evening, when the people were going to and from work, the cars were crowded, but in the middle of the day they were comparatively empty. Philadelphia has not the "floating population of New York," etc.

Mr. Robert C. Givins, in an article published in the *Chicago Tribune*, speaks as follows concerning car-heating, and publishes a letter from Mr. Harrah in support of his views: "Heating the cars is not practicable, at least there is no invention yet discovered that will answer. I give you a letter I have just received from the vice-president of the Eighth street (Philadelphia) line: the communication on this point will be of interest:

PHILADELPHIA, Pa., JAN. 1.—*Mr. Robert C. Givins*—MY DEAR SIR: I am in receipt of your favor of the 30th ult. Some five years ago we did heat our cars in winter time, but were compelled to cease doing so on account of the danger that threatened our passengers. Two of our cars were burned up, owing to the woodwork becoming charred through the heat of the stoves in them. We are now waiting for some inventive genius to perfect a system for ventilating and heating cars, when we will again try the experiment. I regret I can not give you any more satisfactory information. Yours, very truly, CHAS. J. HARRAH, JR.
Vice-President."

* *

FOREIGN ITEMS.

BERLIN.—The great horse-car company of Berlin, which owns all or nearly all the horse-car roads in the city, has to pay the municipality 6 per cent. of its gross earnings, which will reach for 1885, the sum of \$2,312,000. The income of the city of Berlin from the horse-car passenger traffic amounts, therefore, to \$138,720. The city of Chicago derives \$18,000.

SKIBBEREEN.—One hundred tram-car employes at Skibbereen, Ire., have struck work because horses belonging to a boycotted person are employed by the tram-car company.

BELFAST.—The Belfast Street Tramways Company has just paid a half-yearly dividend of 6½ per cent. and the Great Southern & Western Railway has paid a dividend, half-yearly, of 4½ per cent.

SCOTCH TRAMWAYS.—Street-car routes in Scotch cities are laid off in districts, the fare within each being a penny. The passenger pays a penny on entering, and, as each new district is reached, the conductor collects another penny. The system is found to encourage short rides—the most profitable to the companies.

MEXICO.—The *Chicago Times* thinks that Mexico must be the elysium of car-drivers. In that happy country these estimable persons smoke cigarettes and read novels while driving, and passengers get on the cars without pretending to catch the driver's eye.

LONDON TRAMWAY CO.—The directors of the London Tramway Company have just declared a dividend of 9¼ per cent. The success which attended the business of the company has been felt by the directors to be due to the faithful services of their employes, and they have given a bonus to all who have been in their service two years and upward. The foremen of yards got \$50 each, and drivers and conductors \$12.50.

STREET RAILROADS ABROAD.—It is something less than thirty years since George Francis Train obtained power to lay down an experimental tramway from Kensington common to Westminster road, a distance of about a mile, and, although the work was most unsatisfactory to the promoter, as it had to be taken up at his own expense after a very short existence, in it we must recognize the germ of a great industry from which the public is perhaps deriving greater advantage than those whose money has brought about its development. The experimental mile has now grown to 656 miles in England and Wales alone; representing a total expended capital of £9,813,074 out of the authorized £14,951,846. These miles and money are divided between 136 undertakings, which gives an average length of a little under five miles for each, with an average capital of £72,155. This is made up, of course, of small lines in remote provincial towns and undertakings of greater magnitude by which the metropolis and large cities are served, from Blackpool, with its mile and a quarter of road, constructed at a cost of some £7,000; to Liverpool, London, and Manchester, where the capital is counted by hundreds of thousands. It appears that the growth of tramway enterprise during the past ten years has been steady, although not altogether satisfactory in a financial point of view. In 1876 the total amount of capital invested in this kind of security was £2,667,300; representing ninety-four miles of road. Two years afterward the capital had grown to £4,657,633, and the miles to 194, and in 1880, £6,750,000 of capital was invested, representing 269 miles of road. So year by year the enterprise has grown, until we find recorded for the twelve months ending the 30th of June, 1885, a total length of line amounting to 656 miles, constructed at a cost of £9,500,000 of money. The advance in construction has undoubtedly been rapid, even more so than the commercial results would warrant, as profits have, on the whole, certainly not been in a fair proportion to the risk of such trading concerns.

On the English and Welch lines it appears that the total gross income from all sources earned during the past year was £2,094,276, of which £1,601,270 was absorbed in working cost, leaving net, £493,006 as a return upon a paid-up capital of £9,682,116. Taking the income and expenditure in round figures, we may set the former at £500,000 and the latter at £10,000,000, which shows in the aggregate a return of 5 per cent. all around among the 136 lines, of which nine serve the metropolitan area.

With tramways as with railways, success necessarily depends upon the locality to which their operations are confined, and thus we find substantial profits earned in some places, smaller returns in others, and absolute losses in others. The nine London lines figure for an expenditure of capital to the amount of £2,795,182; but from this we must deduct £123,000, the amount which the Croydon and Norwood represents, as only six months' returns are given in that case, and then we have left eight lines, standing at a cost of £2,612,182.—*London Railway Times.*

RAILWAY REGISTER DECISION.

CIRCUIT COURT OF THE UNITED STATES.

DISTRICT OF NEW JERSEY.

| | |
|----------------------------------|--------------------------|
| RAILWAY REGISTER MAN. CO. | } On Application for Re- |
| NORTH HUDSON CO. R.R. CO. et al. | |

By NIXON, J.—This is an application for the reargument of the above case, upon the testimony, and under the same circumstances, under which it has been before argued and decided. The only ground set forth in the petition for the court to open the case and grant the motion, is, that the defense that "the devices claimed in the complainant's patent did not constitute a patentable invention," was not fully presented on the final hearing.

The application for a re-argument, it is true, is addressed to the discretion of the court. The exercise of such a discretion, however, is not willful, but is governed and determined by certain well-established principles.

In *Atlantic Powder Co. vs. The California Company*, 5 Feb. Rep., 187, Mr. Justice Field tersely says, that a re-argument is never granted to allow a rebash of old arguments, and that the proper remedy for errors of the court on points argued in the first hearing, is to be sought by appeal when the decree is one which can be reviewed by an appellate tribunal. The present case is one of such character.

The grounds on which courts ordinarily listen to such applications are (1), upon all allegations, that any question decisive of the case and duly submitted by counsel, has been overlooked by the court, or (2), that the decision is in conflict with an express statute, or with a controlling decision, either overlooked by the court, or to which the attention was not drawn through the neglect or inadvertence of counsel.

Neither of these reasons is shown or alleged to have existed. The counsel for the defendants simply state that one of their defenses was not fully presented. If not, why not? No limitation or constraint was imposed in the argument. It happens that the very ablest counsel are often dissatisfied with their presentation of the most important causes, but that has never been regarded as a satisfactory reason for the court to allow them another opportunity.

The solicitors of the defendants, who unite in an affidavit to secure the rehearing, say, that "it can be readily shown, on a re-argument, that in view of the state of the art, all the elements of the alleged combinations of the three claims in suit are old, and that there was no new result obtained by their alleged combination, but that the same advantage, alleged by complainant to be brought about by their combination, was old and well known in fare-registers."

This does not quite meet the case. The latest

decision of the supreme court on this subject, which has come under my observation, was made in *Stevenson vs. The Railway Company* (114 U. S., 149). The opinion which I filed in this case, I quoted what the supreme court there said was the rule in regard to combination claims, where the elements were old, to wit, that such combinations were patentable, where a new and useful result was produced by their joint action, or an old result in a cheaper or otherwise more advantageous manner.

The counsel for the defendants were probably misled by the hasty and meagre comments which I made upon the quotation, and inferred that I meant to assert that only a new and useful result would sustain such a patent. The opinion further states, and I ought to have added, that an old result may be sufficient, when it is produced by the combination in a cheaper or otherwise more advantageous manner.

I think the complainant's mechanism does this, and hence a re-argument on the question of novelty would subservise no useful purpose.

The application is therefore denied.
A true copy, S. D. OLIPHANT, Clerk.
[SEAL.]

NOTES AND ITEMS.

CABLE GRIP.

A cable grip has been patented by Mr. Lewis B. White, of New York city. The gripping-jaws are on the lower ends of levers operated by a piston working in a cylinder, the piston making the grip take hold on the admission of compressed air to the cylinder, and allowing the hold to be released when the compressed air is permitted to escape.

THE PASSIMETRE.

This is an ingenious contrivance in the form of a turnstile for registering passers. It was invented by Mr. D. A. Bradford, and is in use on the elevated road at Greene ave., N. Y. Tickets are dispensed with, as each turn of the stile admits and registers a passenger. Another unique contrivance is on exhibition at the company's office. It was invented by Mr. Headley, of the Pennsylvania road, and consists of two metal tubes, a counting machine, a hopper

and a lot of red and white balls, like marble. The balls are of different sizes, the smaller representing a five-cent fare and the larger ten. The agent takes in the money and works the spring. The spring throws a ball at the passenger, and this he drops into the hopper, where it sorts itself out and rolls into the proper tube.

"NATIONAL CAR AND LOCOMOTIVE BUILDER."—Our old friend, Mr. Angus Sinclair, editor of that journal, drops us a postal card announcing that the western office of the paper has been changed to room No. Ten, 175 Dearborn street, Chicago.

FIVE IMPORTANT TECHNICAL MONTHLIES which have joined hands for mutual help and the public good, are *Power and Transmission, Mechanics, The Stationary Engineer, Railway Mechanics, and THE STREET RAILWAY GAZETTE*. Send this office for club rates of *THE STREET RAILWAY GAZETTE*, with any one or more of the others.

J. W. CRABBE has invented a cable which would, he believes, entirely abolish accidents to the bridge cars. He claims "a railway traction cable whose diameter enlarges and diminishes at recurring intervals in its length. The combination with a railway traction cable, whose diameter is made to enlarge and diminish at recurring intervals in its length, of a grip carried by a car moving upon the railway, and formed to embrace tightly the smallest diameter of the cable, and thereby prevent a movement of the enlarged portion of the cable through or between its gripping jaws or wheels."

MR. JULIUS G. WALSH, president of the Citizens, Union, and Northern Central railways, St. Louis, also of the American Street Railroad association, has ordered of the Brownell & Wight car company an entire new equipment of forty cars for one of his lines.

BOWLER & Co., of Cleveland, Ohio, are increasing facilities for the prompt handling of street railroad work. The latest addition to their extensive plant is a brick furnace for annealing wheels. They report business as good, having recently filled orders for wheels, turnouts and crossings, from Iowa, Wisconsin, Kentucky and Nebraska.

THE JOHNSON STEEL STREET RAIL CO.—Messrs. O. W. Meysenburg & Co., the western agents, have opened an office in Chicago, in the Adams Express building, 158 Dearborn street, room 7, second floor, where they will be glad to receive all their street railway friends. They will have on permanent exhibition a full line of street railway track material, etc., including the new Johnson girder rail.

THE BROWNELL & WIGHT CAR COMPANY, St. Louis, has completed the equipment for the new cable line in that city, including twenty grip cars. These are an improvement on the usual usual style of grip cars, inasmuch as the variation in the load of the car does not change the relative position of grip and cable.

Grip cars of this pattern, built by the same firm, have been in service for some time on the Kansas City cable line, and are working successfully.

When you see a man call the conductor's attention to the fact that there are only ten persons sitting on his side of a crowded horse-car, just look a little closer and ten to one you'll find that he is sandwiched in between two pretty girls.—*Somerville Journal*.

WANTED POSITION

By a practical Street Railroad man of 10 years experience in the management of employes and office details. Strictly temperate, and can furnish reference from Street Railroad Officers and others. Address

S. LAMBERT,
177 Bank Street. Cincinnati, Ohio.

C. A. PALTZER & CO.,

LUMBER

2598 Archer Avenue, CHICAGO.
Ash, Oak and other Hardwoods suitable for Car and Track Work.
WRITE FOR ESTIMATES.

O. W. MEYSENBERG & CO.,

WESTERN AGENTS

Johnson Steel Street Rail Co.

JOHNSON STEEL GIRDER RAIL
AND STEEL ROLLED CURVES,
Switches and Frogs, also Metallic Ties,

185 Dearborn Street, Adams Express Bldg., CHICAGO.

ST. LOUIS, 204 North 3d Street, Gay Building.



Car Wheels
OF ALL KINDS
FITTED TO AXLES.
Street Railroad Turnouts,
Transfer and Turntable,
Barn Drain Troughs and Fittings.
BOWLER & CO.,
11 Winter St., Cleveland, O.

EATON & PRINCE,

MANUFACTURERS OF

ELEVATORS

FOR
Passengers AND Freight.
ALSO,

SPECIAL ELEVATORS
For STREET CAR BARNs.

74 & 76 Michigan St., CHICAGO.

Chicago Malleable Iron Co.,

MANUFACTURER OF REFINED

Malleable Iron Castings,

Western Avenue & 26th Street,

CHICAGO.

✽ Street Railway Work to Pattern. ✽

Barnum & Richardson Man'g. Co.,

64 South Jefferson Street, CHICAGO.

CHILLED STREET CAR WHEELS

FROM PURE SALISBURY IRON.

Curves, Frogs, Switches, Crossings, Etc.

To Any Pattern.

Light and Heavy CASTINGS for all purposes.

W. H. BARNUM, ALBERT ALLING, WM. E. BEST,
Pres., Lime Rock, Conn. Gen. Mgr. & Treas., Chicago. Sec'y, Chicago.

F. W. DEVOE & Co.

ESTABLISHED 1852.

Fulton Street, Cor. of William, NEW YORK,

MANUFACTURERS OF

COACH AND CAR COLORS

Ground in Japan. These colors received the highest award, the Gold Medal, at the National Exposition of Railway Appliances in Chicago.

SPECIAL SHADES MADE TO ORDER.

We furnish special body colors to Pennsylvania R. R., New York Central, New York & New Haven, Lehigh Valley, New Jersey Central and other large Railroads. Special shades for Stations, Freight Cars and Caboose—Bridge and Roof Paints.

FINE VARNISHES AND JAPANS

FOR COACHES AND CARS,

Wood Fillers, Wood Surfacers, Wood Stains, Hard Oil Finish.

PURE MIXED PAINTS

Guaranteed to be made only of Pure L used Oil, and the most permanent pigments. Sample cards of 30 desirable shades sent on request.

BRUSHES of every description for Artists, Painting, Varnishing, Gilding, Stripping.

WHITE LEAD, ZINC WHITE, COLORS IN OIL.

ARTISTS' MATERIALS.

F. W. D. & CO.'S Tube Colors.
F. W. D. & CO.'S Fine Brushes.
F. W. D. & CO.'S Canvas.

CORRESPONDENCE INVITED.

COFFIN, DEVOE & CO.,

176 RANDOLPH STREET, CHICAGO, ILL.

THE

L. L. Brown Paper Co.,

Have for thirty-five years made a specialty

OF

LINEN LEDGERS.

Their make of Papers are to-day recognized as THE STANDARD for strength of Fibre, erasing and re-writing qualities.

Stationers and Blank-Book Makers

Everywhere will furnish this brand.

EACH SHEET is water-marked with trade mark of name and date.

MILLS AT

ADAMS, - MASS.

European Colic Cure.

A speedy and sure cure for Colic—has saved hundreds of horses where all other remedies have failed. Horse need not be run or trotted around to start the wind. Let him stand or lie down as he feels inclined and he will be ready for work almost immediately after recovery. A cure guaranteed in ninety-nine cases in a hundred. Endorsed by the leading street railway companies of the country, some of which we append:

DECATUR, ILL., Oct. 2, 1884.
MESSRS. JONES & ROACH, Chicago.

I have used your Colic Cure for my horses and mules on my street car lines, and found it the best and surest medicine I have ever used. I have not lost a horse since I commenced its use. It gives relief in a short time after it is taken. I can cheerfully recommend it as a sure relief if given in time. I keep it constantly on hand.

Truly yours,
FRANKLIN PRIEST,
President Decatur Street R. R.

MESSRS. JONES & ROACH:

Gentlemen:—I cheerfully recommend your European Colic Cure for horses as being the best that I have ever used. When once introduced no horse owner can well afford to be without it. I hope you

will meet with the success your cure deserves.

Yours truly,
VALENTINE BLATZ,
Per H. LIEB, Manager.

OFFICE OF NORTH HUDSON }
COUNTY RAILWAY CO. }
HOBOKEN, N. J., Oct. 4, 1884. }
Gentlemen:—It gives me pleasure to say that I can heartily recommend your European Colic Cure to all horse owners, from a personal knowledge of its curative qualities. I have used it in our stables, containing about six hundred horses, and have always found it to be beneficial.

Yours very truly,
ALBERT SAILLET,
Foreman and Veterinary Surgeon for the North Hudson County Ry. Company.

Sample Bottles Furnished Street Railway Companies Gratis.

For further information, prices, etc., address

JONES & ROACH,

259 Fremont Street, - CHICAGO.

THE
Street Railway
GAZETTE.

VOL. I. CHICAGO MARCH, 1886. NEW YORK No. 3

WILLIAM RICHARDSON,

PRESIDENT OF THE ATLANTIC AVENUE RAILROAD COMPANY OF
BROOKLYN, N. Y.

Mr. William Richardson, who has been especially prominent in the public eye, during the past month, is an Englishman by birth, having been born in Berkhamsted, Hertfordshire, on Sunday, the eighth of December, 1822, the eldest son of John and Sarah Richardson. His father, the youngest son of his parents, Thomas and Sarah Richardson, was born in London, Feb. 12th, 1803, so that at the time of William's birth, he was himself under twenty years of age.

When William had passed his sixth year, the parents removed to London, and here resided for some years.

The school privileges of the young Richardson were very limited, and he himself says, "I never went to school a day after I was ten years of age, and yet I can not remember the time when I could not read. Being the first born, his father took great personal pains with his primary education, so that he learned to read and spell at a very early age.

On reaching the age of ten years, he found employment in the office of John T. Gannon, Barrister, Elm Court, Middle Temple, London, where he remained until his departure for America. During the course of this employment, he found time for rather extensive reading, and posted himself with special thoroughness in Hale's History of the United States, Hume's History of England, and other works valuable for future use.

On the 2nd of September, 1834, the father, taking with him William and John,—a younger son, four years William's junior—sailed for America in the packet ship "Sovereign," which landed them in New York on the 17th of November. They set out at once for the town of Gambier, Ohio, a journey which required a week to accomplish, by the quickest route then available. This was by steamboat to Albany, by cars from thence to Schenectady. The rail line started from the north side of State St., near Eagle St., and the cars were drawn about three miles by horses, when they were turned over to the locomotive which hauled them the rest of the way. This railroad, 17 miles long, was at that time the only one in operation between the city of Albany, and all the west. The remainder of the journey was made by way

of the Erie Canal to Buffalo, steamboat on Lake Erie to Cleveland, and thence by stage to Mt. Vernon.

The senior Mr. Richardson went to Ohio with high anticipations, which he failed to realize, and therefore, after placing the subject of our sketch in the office of the *Knox County Republican*, he set back to England; though some two years later he returned to America and settled in Albany, N. Y.

William remained in the Mt. Vernon printing office over a year, and left the employment to go on a farm with some relatives. From here he went into the store and family of the Hon. E. Miller, at Mt. Vernon, and later, into the store of T. W. Rogers & Co., of the same place.

During this time, when 14 years of age, he united with the Baptist Church in Mt. Vernon, and was baptized in Vernon River, on Christmas day, 1836.

The year 1840, was filled with the Harrison campaign, in which William Richardson, then well advanced in his eighteenth year, was a thorough enthusiast; and during that year he forsook the state of Ohio, and taking up his abode in the city of Albany, N. Y., continued to reside there for nearly twenty-five years.

For some years after this, his experience was varied.

During the summer of 1841, he was clerk in the Hudson St. Temperance House, Albany, kept at that time by A. C. Churchill. The next year he embarked in the business of umbrella making, and in 1843, opened a paper and paper-hanging store, at No. 60 South Pearl St., continuing in this business until 1850.

On September 22nd, 1844,

he was married to Miss Mary Freeman,—daughter of James and Ann Freeman,—with whom he is still living happily. They have had seven children, four of whom, three sons,—including William J. Richardson, Secretary of the Atlantic Ave. Co., and of the American St. Ry. Association,—and a daughter, are now living.

Mr. Richardson was very active in the great temperance movement which swept over the country some thirty-five years since, and in 1850, assisted in the formation of the Grand Division of Western New York, of which he was elected the first Grand Worthy Associate. During the temperance and prohibition agitation, which followed this

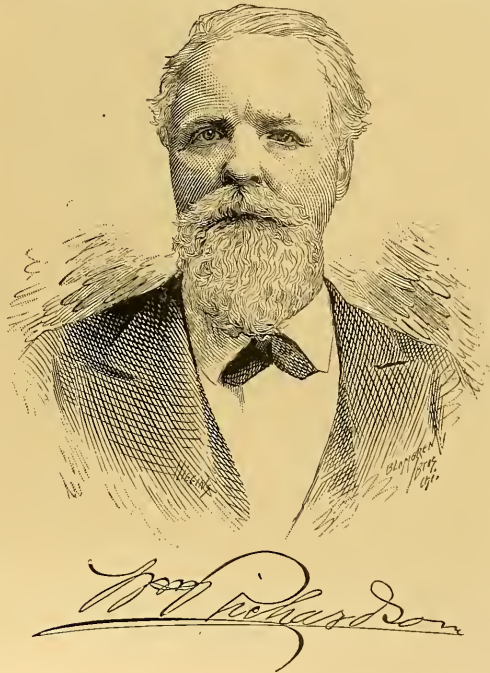

movement from 1850 to 1854, in New York State, he took a prominent part, as he also did in the "Anti-Nebraska" and "Free-Soil" agitation which led up to the formation of the Republican Party, in 1854. He was a member of the first State Committee of this party.

In politics Mr. Richardson was always fervently anti-slavery, and his first vote in a presidential contest, was cast in 1844, for James G. Birney. In 1848 he voted for Van Buren and Adams, in 1852 for Hale and Julian, and since its organization, he has always acted with the Republican party.

In 1857 he was elected Clerk of the New York State Assembly, and received re-election for the two terms following; and during the memorable session of 1858, when there was a "tie" in the house, he fulfilled the double duties of Clerk and Speaker for six weeks. Following this severe mental and physical strain, he was prostrated by a severe illness and fever, as a result of which his hair rapidly whitened, till it became like snow.

He was engaged for a short time as proof reader on the *Albany Evening Journal*, and on June 1st, 1861, was appointed Additional Pay-master in the United States Army, to which post he received his commission from President Lincoln, Aug. 13th. He continued in this office three years, his bondsmen being Governor Edwin B. Morris, and the Hon. Thurlow Weed. Over six millions of dollars passed through his hands during his service. About six months previous to his retirement from this post, he was ordered to New Orleans, but during his stay in that city, his father-in-law died, and he was persuaded by his family to tender his resignation and return to his home.

In 1865 he was elected a director of the Dry Dock, East Broadway and Battery Railroad Co., of New York City, and within a few weeks following, received the election to the presidency of that road. His administration proved very efficient. At the time of his appointment the income of the road amounted to about \$600 per day; but by means of several judicious extensions and additional grants from the legislature during his régime, the receipts of the company had risen, in the short space of two and a half years, to over \$2,000 per day. It will be remembered that during Mr. Richardson's presidency, an attempt was made by the company to cross Broadway with its tracks, from Ann St. to Fulton St., in front of the Herald Building and the Old Dutch Church. These connections were not allowed to remain, but the rails were taken away.

In 1867, Mr. Richardson was induced to take a 40-years lease of the Brooklyn and Jamaica Railway Co., and he entered upon the prosecution of this enterprise as a personal venture, on the 15th of November of that year. The road was in a very dilapidated condition, but he continued to operate and improve it without financial assistance, till 1872, when a first mortgage, issued by the original Brooklyn and Jamaica Ry. Co. upon the property, becoming due, and the lessor being unable to meet the obligation, a syndicate was formed, by which the road was purchased, subject to the remaining indebtedness outstanding, and a new company, now known as the Atlantic Avenue Railroad Company of Brooklyn, was organized to own and operate the road.

By reason of extensions and additions, this road has rapidly grown in importance, until at the present time, it comprises seven independent lines.

In 1870, Mr. Richardson received the nomination on the Republican ticket for Alderman of the 22nd ward, Brooklyn, and though this had been hitherto a Democratic ward, he was elected, and in 1872 was re-elected. In 1878, he was nominated by the Republicans for the State Senate, but was defeated, and since that event he has considered himself out of politics and in business, strictly.

He is somewhat publicly known as "The Deacon, honorary title conferred upon him by the late Hon. Thos. Kinsella, former editor of the *Brooklyn Eagle*. As a matter of fact, however, he is not and has never been a deacon, having too high an appreciation of the duties of the diaconal office, to allow himself to assume them. He is sometimes addressed familiarly, and perhaps cordially, by that title in

the course of business; and the man who has failed to do any business with Mr. Richardson, may not have appreciated the fact that his, so-called, cordial greeting, "settled the business" for him.

Mr. Richardson is still, at 64 years of age, a hale and vigorous man, powerful of will, clear-headed, a great organizer and a born governor of men. His friends can always rely upon him, and his word is as good as his bond. He is a man who has been much talked of in the press, and if we should judge a man alone by what we read of him, Mr. Richardson should be considered one of the deepest-dyed villains that walk the earth; but those who know him best, know that he is often misrepresented, and that any man as prominent as he in the service of the public, must almost inevitably suffer by having his fair name smirched in the public press. For lies told about him he cares nothing; the truth is seldom told, for it is that which few men care to have made public property, and whatever may be said or thought of him, Mr. Richardson, like all men of strong personality, makes enthusiastic friends and determined enemies.

COMBINED FARE-BOX AND LANTERN.

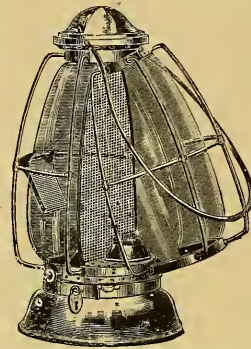

The purpose for which this invention is intended may be briefly stated as follows: To enable our great Railway and Horse Car companies to protect their interests by proper and full returns to their treasuries the fares collected by their duly appointed agents.

It is well known that this subject has engaged the attention of directors and others in no small degree ever since passenger traffic has assumed any considerable importance. And while many plans and devices have been employed to correct abuses, yet no perfect system has been found to fully meet the case (if we except that known as the "Bob-tail" car in use on some of our street railways). This, however, is limited in its application, being stationary. Aside from this, other devices are employed—such as the bell-punch, duplex and registers (which sometimes fails to punch or register as expected). These are sometimes supplemented by what are called "spotters," at great expense and unreliable. All of which fail of fully correcting the evil justly complained of.

The combined Fare box and Lantern is designed as a depository for cash fares by passengers—conductors being prohibited from receiving or depositing the same, but are supplied with currency to make change in full for any amount offered. From the change thus returned the passenger deposits the exact fare in the chute where it falls upon the plate where it can be seen and if found correct it is tilted into the money-box at the bottom. The same being under lock or seal can not be opened until it is turned over to the proper officer or receiver, whose duty is to receive the same, open and count the contents and another lantern duly trimmed is given in exchange for return trip, etc. This invention being provided with a lamp and accessible is to serve for day and night use. Is not unlike any conductor's lantern in appearance and size materially. If used in connection with the duplex register or punch they serve as a complete check on each other. The amount the duplex punch or register call for should correspond with the cash found in the box, and the cash in the box when opened should tally with the registers.

NEW ROADS & FRANCHISES.

Special attention is called to the activity existing in street-railway matters, as evidenced by the number of new roads and franchises reported among our "pointers."

MECHANICAL ARRANGEMENTS OF THE NORTH HUDSON COUNTY CABLE RAILWAY.

This road extends from Hoboken to Jersey City Heights, a distance of a little more than one mile. The method of running curves consists of a series of double width and double groove pulleys for carrying the cable; also upright, wide-face grooved pulleys for guiding the cable around the curves. These radius pulleys are so placed that the cable, when in the grip, is held away from them, thus preventing danger of striking, and doing away with the necessity of pulleys hung in swinging frames, which can be pushed out of the way when the grip comes in contact with the swing frames.

The operation of these pulleys is fully illustrated by Fig. 5, and the position occupied by the cable is also there shown.

By means of a simple arrangement, the cable lifter (Fig 3) will take up the cable at any point on the road, except on curves of very short radius.

The grip, the action of which is illustrated by Fig. 1, is about 3 feet long and consists simply of two pieces of cast iron, between which the cable is pressed.

In starting the car, pressure is applied gradually until the car is about up to speed, then the grip is set up sufficiently to carry the car to the foot of the grade, when a final application of the hand-wheel makes sure that the grip-pressure on the cable will carry the car to the top of the grade without slip. The car, when starting from the stations, will get up to speed (which is $9\frac{1}{2}$ miles per hour) in about $1\frac{1}{2}$ to 2 times the length of the car; and this is done without perceptible jar to car or passengers.

The grip and brake are both operated by a single hand-wheel, but the connections are so devised that it is impossible to connect with both grip and brake at the same time.

In Fig. 2, *A* is the lever to which the grip-bar *D*, Fig. 1, is connected. The chain from the brake is attached to the eye-bolt *C*, and is wound around the grooved pulley in the usual manner.

At *D*, a lever is connected, which projects through the platform of the car near the grip and brake hand-wheel. By operating this lever, either of the clutches *B* or *E* may be put in connection with the worm wheel *F*.

As seen at *H*, which shows the clutch in pulley *G*, both *C* and *J* are loose upon the shaft, and can not be moved until they are brought separately into gear with the worm wheel *F*.

At *I*, the nut and washer *J* are shown with the lever *A* removed. *G* is the worm on the upright rod which carries the hand-wheel by which brake and grip are worked. It will readily be seen from the engraving, how *G* is brought in contact with the wheel *F*.

As seen in Fig. 1, the grip consists of two heavy jaws, which are made of cast iron and cored out their whole length to receive the shoes *II*, which receive all the wear from the cable, and can be readily replaced by removing the bolts *JJJJ*.

The grip jaws are dovetailed to the body of the grip; these dovetails are shown by *G* and *II*.

At both ends of the grip are levers similar to those shown at *A*, *B* and *C*, which last, is connected to *E* and *A*, through portions of the grip not shown.

As lever *C* is moved to the right by turning the hand-wheel on the brake and gripshaft, which is connected with *D*, as before shown, *A* is revolved upon its axis, the lever *B* is drawn downward and a similar lever, which is connected with the upper end of *A* and the point *F*, is drawn upward, thus closing the jaws *II*, and grasping the cable with tremendous power. These levers act upon the well-known principle of the toggle or elbow joint, exerting their greatest power as they approach the end of their movement.

The cable lifter is shown in Fig. 3. The cylinder *F* slides easily through a cast-iron bolster which is shown in the large engraving. Connections *EE* are short links, to which are attached levers and weights sufficient to partly balance the weight of the apparatus shown in Fig. 3. The lever is connected to rod *A*, which runs through the hollow cylinder *F*, and is connected to the jaws *CC*, as shown at *B*. The lever, previously mentioned, is held by the catch *I*, which is made fast to the platform by a lag screw. The hook *H* carries the lever. When it is

desired to lift the cable, the lever is thrown backward out of catch *I*. This movement causes rod *A* to be depressed to its present position, opening the jaws *CC* as shown, and lowering cylinder *F* from *B* to the upper collar. The jaws *CC* are now on either side of the cable. When the lever is thrown forward, rod *A* and links *B* are raised, the jaws *CC* close loosely round the cable. A further movement of the lever raises Fig. 3 bodily, carrying with it the cable. When the lever is caught by catch *G*, the collar *D* is in contact with the bolster as seen in large engraving, and the cable is in position to be caught by the grip. After the grip has been locked upon the cable, the lever is thrown back to catch *H*, which opens the jaws of the lifter sufficient to allow the cable to drop when the grip is again unlocked.

The cable is carried upon light pulleys like *A*, Fig. 5. These are placed about 30 feet apart except upon curves. The point *E* shows the relative position of cable and pulley when the grip is passing. At the curves a pulley is used in place of *A*, which has its face of double width and carries two grooves instead of one.

At *G* is shown one of the guide pulleys used on the curves; *D* shows the position of the cable when the grip is

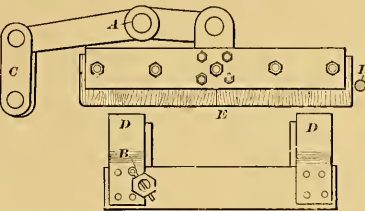
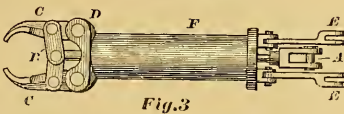
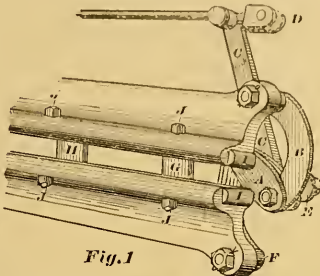

Fig. 4 NORTH HUDSON COUNTY CABLE RAILWAY.

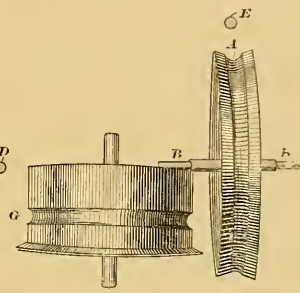
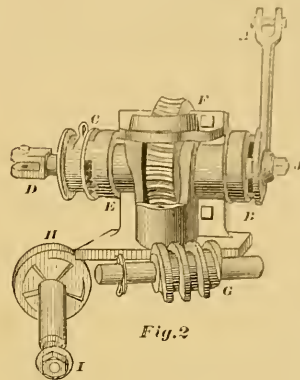

Fig. 6

passing, and also illustrates how the grip is enabled to pass these carrier and guide pulleys without striking them.

When upon a curve the cable lifter is unable to pick up the cable, but this is the only "dead point" possessed by this apparatus.

The objection may be raised that the lifter might come in contact with one of the carrier pulleys *A*, and thus be unable to get hold of the cable. But as there is a lifter at either end of the grip, and a grip at each end of the car, the distance between carrier pulleys being unequal to the distance between grips, it is impossible to place the car in such a position (upon a straight track) that two of the four cable lifters cannot get hold of the cable.

In addition to the regulation brake, a track brake is used, which is shown in Fig. 6. The guard rails of this road are made of iron. *E* is a set of wooden blocks connected to the lever shown, which fulcrums at *A*, on the pin *B*. This part of the brake is reversed in position, the guides *DD* sliding down over *E*, and pin *B* passing through hole *A*, the whole being bolted to the car just above the guard rail, and power applied by a lever through the link *C*. The wood *E* is forced down upon the guard rail, and forms a determined obstacle to the movement of the car.

The grip and cable lifts are made fast to the truck frames, instead of to the body of the car, thus preventing the possibility of a heavy load springing the car, so the grip can get out of its proper position.

The cable which is about $1\frac{1}{2}$ " in diameter, is expected to and does stretch constantly. It began stretching when first placed upon the pulleys, and will stretch until it reaches a point at which the safe limit of elongation is reached. Then a new cable is in order, and the stretching process is repeated.

A new wire cable, like a new rope, is comparatively open in its strands. By continuous bending, the wires forming the strands are brought closer to each other; therefore, they can straighten a little, which gives greater length to the whole cable.

Bending the cable around pulleys must, of course, cause motion between all its strands. This motion will, in time, cause wear; the cable keeps getting smaller and smaller, and consequently grows longer. As will be seen above, stretching of the cable is a necessary condition of its use.

As the cable stretches, the slack is taken up by means of a large pulley hung upon an inclined plane. The pulley can be weighted to keep a constant tension upon the cable, regardless of expansion by heat or contraction by cold. The cable is received in the engine-house upon a 12-foot pulley, having six grooves cut in its face. The cable takes a half-turn around this pulley, and then passes to a similar pulley, around which it also takes a half-turn and then passes to the tightener.

As the cable stretches, and the tightening pulley reaches the lower end of its inclined track, the cable is given another half-turn around the driving pulleys, thus increasing its hold and securing greater driving power.

It has been found that the liberal use of tar upon the cable must be avoided when two or more turns have been taken around the driving pulleys. The tar, by collecting upon the first groove of the receiving pulley, soon increases the diameter of the pulley at that point, and causes the cable to be slack during its return to the second driving pulley, and may cause the cable to slip off the driving pulleys.

The grip is the invention of J. J. Endres, of New York, who was the engineer in charge of the construction.

[By courtesy of *The American Machinist*.

TRANSIT DIFFICULTIES.

That portion of the city of New York that lies south of the Harlem River is a long, narrow strip of land, bounded by water. The North River will probably never be bridged, and the East River is difficult to span. The Harlem, on the other hand, presents little trouble in this respect. The consequence is, that the natural outlet of the city is into Westchester County, and in fifty years it will have advanced so

far as Tarrytown. As the city is constructed, and as business is now carried on, the courts, most of the banks, the insurance offices, all manner and kind of middle-men, the post-office and the exchanges, are all located in its extreme lower section. Immense sums of money have been and are now being invested in the erection of the finest and largest commercial buildings in the world. It is next to an impossibility to transact any commercial, financial or legal business without traversing the length of the city. Then, the fact that this section is fringed about by docks, stores and warehouses, that create a large transverse travel for the trucks and traffic wagons, is a matter that must be taken into consideration. How to get down town and back again, safely and expeditiously, is the great problem. In the mean time, with the increase of population, the difficulties cumulate. Each year the number of persons that must be carried to and from increases, but the facilities for travel do not keep pace with this rapid growth. During the last thirty years there has been an average yearly increase in passenger traffic of 9,000,000, and population has increased forty-six per cent. The present roads, including the elevated ones, can not do the work required of them. The growth and development of New York, that has been stimulated by intramural transit, has overcome the capacity of the present roads. The truth is, that the elevated roads never did furnish actual rapid transit. At certain hours of the day these cars are so crowded that great delays are experienced in taking up and setting down passengers at the different stations. Below Forty-second street in the morning, and above Chambers street in the evening, it is quite impossible to get a seat. The continuance of the old and establishment of new routes of street railways, are both necessary for the welfare of the city. These surface roads will always do an immense business, but they can not meet the requirements of long distance rapid transit across the narrow strip of land upon which New York is situated. A four tracked, underground road, running the whole length of the city is necessary. The two inner tracks should be for express trains that would carry passengers from the Battery to the Harlem in twenty minutes. The outside tracks could be used for local travel. Such a road would greatly stimulate the increase of population, and with such increase the business of the surface roads would be extended. Certainly so long as the bulk of the business of this community is transacted south of Canal street and the mass of the people are compelled to live above that street, there will be a travel that must puzzle the ingenuity of our civil engineers to provide for. We have pointed out one way to meet the difficulty. In case this underground road is built, the present elevated and surface roads would have all they could do to give accommodation to the short distance traffic. There should be no jealousy. There is enough business for all the elevated, surface and underground roads we may construct. Even in London, where the shape of the city made the solution of the problem of intramural transit much easier than in New York, an underground road was necessary. Lockwood.

ANALYSIS OF STRIKES.

We have given in our various issues several editorials upon the subject of strikes, which will bear close reading. They are by different hands, but by writers who have made a special study of the labor-capital question, and contain food worthy of rumination and digestion by both employer and employé. We do not intend to let this subject drop, nor do we intend to conceal any fact, even though it should tell against us, but will be, as far as in us lies, a fair judge and a candid critic, hearing and examining the question in all its bearings. All the right and justice will not be found on either side. Doubtless in some cases employés have real, substantial grievances; and doubts there occur, now and then, rare instances in which they are oppressed or rendered uncomfortable by preventable causes; but for one such case of reasonable demands, there will be found a dozen where the complaints are sentimental or illogical. However, employés and employers alike are usually amenable to reason, and it is the rational side of such cases that we hope to present.

A NEW ELEVATED RAILWAY SYSTEM.

The diagrams shown herewith give views of the Mack system of elevated railways, for which letters patent have just been granted at Washington.

The inventor claims that many, if not all, objections to previously devised systems have been overcome in this method. The structure is symmetrical and offers almost no hindrance to street traffic.

Perfect immunity from danger of cars jumping the track, the greater part of the weight resting on the central rail, which is placed on a much lower plane than the side rails. *Railway Age.*

JUSTICE TO COLONEL PAINE.

Colonel Paine's grip which is used on the Brooklyn Bridge cars has probably received more adverse criticism and ridi-

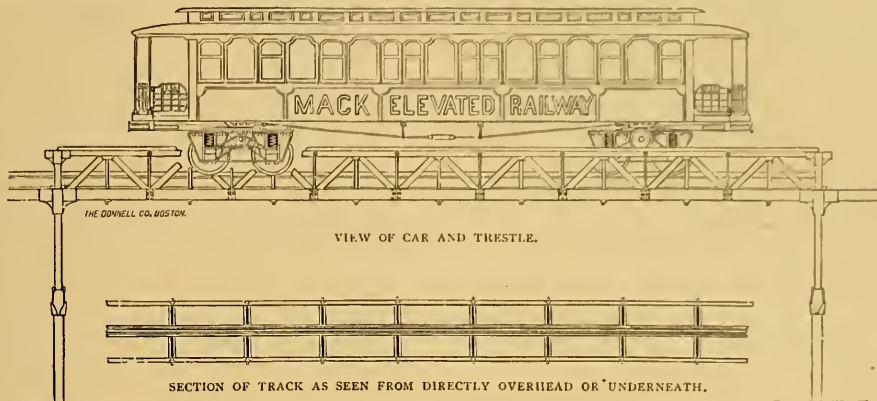

Where streets are narrow, as occurs in the principal thoroughfares of Boston, the structure can be built upon the sidewalk, and will then occupy little more space than an ordinary street lamp-post.

The lower pillars shown in the smaller diagram represent nine-inch columns, set two feet apart and standing eight feet or more from the sidewalk level, so that they do not necessarily occupy more than three feet six inches from the curb inwards on the sidewalk, while the space between the pillars will admit of pedestrians passing between them without any inconvenience.

There being no cross ties on the top of the trestle, obstruction to light in stores and warehouses is reduced to a minimum.

Where the streets are wide, it can be built to straddle the ordinary horse car lines, at a proportionately lower cost, having only single columns of a larger diameter on either side of the horse car track, thereby minimising the objection to such an institution in such street as are used for residences.

BIRD'S EYE VIEW OF TRACK FROM AN ANGLE OVERHEAD.

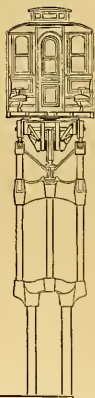

END VIEW OF TRACK WITH CAR.

The cars to be used do not require any special construction, those in use on any of the New York roads being perfectly suitable when placed upon the trucks built for this system.

Among the most important advantages which are claimed for this system are: Adaptability to steam or electric power; great strength of the structure; economy in cost of construction; minimum obstruction to light; minimum obstruction to traffic.

cule than anything extant, if we except the Keeley motor. Now, leaving out of consideration the daily papers, which are no more capable to judge of the merits of such a device than is a wild Choctow, certainly the mechanical papers, which ought to know better, have been very careless in their judgments in the case. The fact is—and we think we can prove the statement—that the Paine grip has made more car mileage with fewer accidents and less expense than any other grip in use anywhere, and, moreover, the bridge cables are doing more service with less wear than any other cables anywhere else. Just let the critics figure it out for themselves, and we think they will conclude that the chief misfortune of the bridge grip is, that its light not being hid under a bushel, it pays the common penalty of greatness and prominence.

LET THE CONDUCTORS RECIPROCATE.

There is, at least, one sensible man among the members of the Quaker City Protective Association. We do not know of a wiser suggestion than that of the Nineteenth and Chestnut Red Line conductor, who said in an interview the other day:

"I've been fourteen years a steam railroader with the Reading and six with the Pennsylvania, and I know something about strikes, and you don't, and I don't believe in them. Do you know what would bring the companies down? Just make it a rule of the association that any man caught knocking down a fare should be reported and turned out at once. Then the companies would save more than they would lose by giving fifty cents more for twelve hours' work than they do for eighteen. What's the extra they'd have to pay? Well, twenty-five cents to a tripper for an hour's lay off at noon and fifty cents more to a tripper for theatre cars at night. I never knocked down a fare yet, but I know what I can do. I can miss as many fares on a trip as I take.

This is reciprocity in earnest, and we commend it on trial to every association of conductors and drivers in the United States. Prove to the companies that you are willing to protect them, and we think they will not be slow in finding out that it will pay them to reciprocate.

EXTRA SHOES.

Some roads have the very commendable practice of carrying in each of their cars, an extra, adjustable shoe. This is very useful, especially where the tip system of shoeing is not used, as a hoof rendered brittle by shoeing, may be pretty badly battered up in a single "bare-footed" run.

EARLY ELEVATED RAILROADS.*

The earliest proposer of a single post line railway, of which I know, in England is Henry Robinson Palmer, whose patent is dated November 22, 1821. He shows a beam carrying a single rail on top and supported upon a line of posts. Upon this rail runs a vertical supporting wheel for the load, which in this case consists of bags carried on either side, like panniers. [Described in *Rep. of Arts*, Vol. I, 3d series, p. 129; *Newton London Journal*, Vol. V., p. 151, Vol. X, p. 32; *Mechanics Magazine*, Vol. XXVII, p. 349; *Register Arts and Sciences*, Vol. I, pp. 97, 131; Vol. II, pp. 150, 353; Vol. III, p. 141; Vol. IV, p. 219; Vol. I, new series, p. 9; Vol. IV, p. 25; *Engineers' and Mechanics' Encyclopedia*, Vol. I, p. 615; Vol. II, p. 425.]

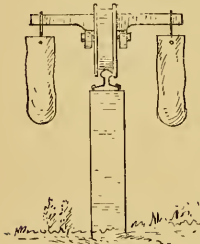

FIG. 1.—PALMER, 1821.

Since then probably over one hundred different patents have been taken out in England and the United States in this line, of which I will briefly refer only to the following: Among the English patents, April 2, 1825, a patent was taken out by Jacob Jedden Fisher, for a suspended railway,



FIG. 2.—FISHER, 1825.

in which weights were shown suspended below the level of the rail on either side, the track itself being supported like the floor of a suspension bridge.

D. Maxwell, May 10, 1829, had a patent on suspended cars.

William Newton, an English attorney, took out a patent, July 30, 1845, upon a rail of ordinary section, having horizontal wheels running upon its sides, close to the ground.



FIG. 3.—NEWTON, 1845.

Another was that of Robertson J. Clinton, June 4, 1846, who provided a central rail between the two ordinary rails, and elevated this rail to a higher position.

July 14, 1846, Sir Samuel Brown took out a patent on a central rail and a wheel having a notched or V groove to run upon it.



FIG. 4.—CLINTON, 1846.

In the United States, we have Henry Sergeant, May 6, 1825, who patented a post line railway carrying a rail on top and vertical supporting wheels carrying panniers of wood, upon either side.

He printed a pamphlet upon it which was published in Boston April 30, 1827.

J. Stimpson, June 3, 1830, also patented a single post line wooden way, having side strips upon the posts.

In the patent of Bryant and Hyett, June 13, 1831, a vertical wheel is shown on a post line railroad, with the load supported by it hanging down on either side of the posts. A similar patent is J. Richards', patented March 9, 1832.

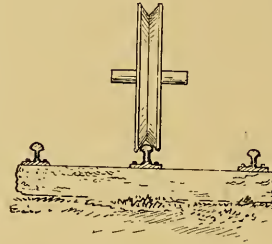

FIG. 5.—BROWN, 1846.

But the nearest approach to the method adopted in the system under consideration was that of U. Emmons, in the United States, April 17, 1837, who in addition to the post line, single rail and wheel on top carrying the car pannier-fashion, and which extended rails upon the posts upon which run horizontal steadying wheels for the lower part of the car.

July 2, 1872, a patent by E. Crew, shows inclined steadying wheels.

To conclude this brief review of these crude and disconnected ideas, but two more need be named.

The "Cameron" Pontoon Cart, proposed for South Africa, may be regarded as the simplest possible form for a railway. It consisted in fastening to the ground by rough, notched sticks, a line of hollow logs cut lengthwise in halves, not unlike a wooden house gutter in appearance. In this groove was a single wheel carrying a basket with arms on either side. This is called, required the equilibrium to be maintained and propelling power furnished by men or animals. Also log railroads have been used, one by Richardson Brothers at a mill near Truckee, Nevada.

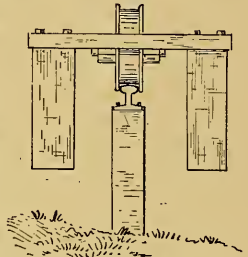

FIG. 6.—SERGEANT, 1825.

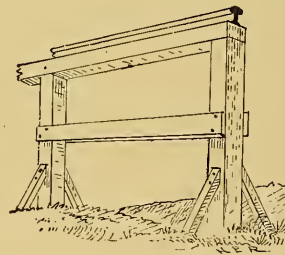

FIG. 7.—STIMPSON, 1830.

and a section was built, with the latter being in form like an inverted V, or on the "camel saddle" principle, hanging upon either side.

The single rail railroad, so called, built at the Philadelphia Exhibition in 1876, over Belmont Ravine, was invented by General Le Roy Stone, of New York. It was elevated about 35 feet and about 500 feet long, really consisting of three rails instead of one the section being not unlike the letter A, with a rail at each angle of the triangle. The supporting rail was at the top,

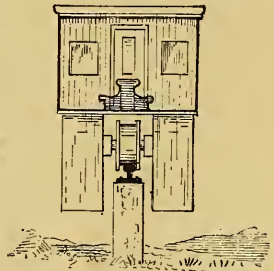

FIG. 8.—BRYANT AND HYETT, 1831.

*Discussion of the paper on "Rapid Transit and Elevated Railroads, with a Description of the Meigs Elevated Railway System," read at the Boston meeting of the American Society of Mechanical Engineers, by Francis E. Galloupe, Boston, 1885

the lower rails carrying the horizontal steadying wheels for the saddle-bag car. It was previously built at Phoenixville,

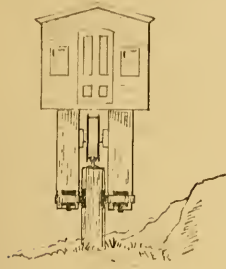

FIG. 9.—EMMONS, 1837.

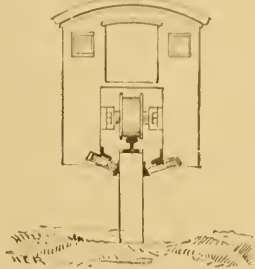

FIG. 10.—CREW, 1872.

Pa. The engine was a rotary one of the La France pattern and connected direct to the supporting wheels by

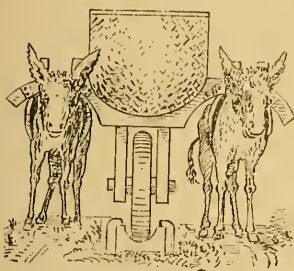

FIG. 11.—CAMERON, 1878.

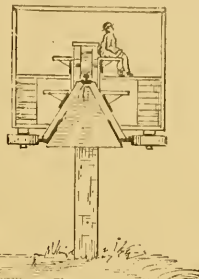

FIG. 12.—STONE, 1876.

gears instead of cranks. One fatal objection to it seems to be its inability to turn curves.

[By courtesy of *The American Engineer*.]

A PLEA FOR THE HORSE.

(Continued from page 41.)

"Lastly, there comes the SOLE, which binds the frog and the wall together. The horn of which this portion of the hoof is made is very different from that of the wall or the frog. It is formed of a number of extremely hard and strong bony plates laid one above the other, and curved so as to form a sort of dome surrounding both sides and the front of the frog. The sole has another object besides connecting the frog and the wall. It is intended to defend the sensitive parts of the interior hoof from stones, sharp points of rocks, and so forth. When the sole becomes worn out, it has the faculty of reproducing itself in a manner quite distinct from that of the wall and the frog. Instead of being rubbed away by friction like the former, or throwing off little flakes like the latter, it exfoliates in flakes, a new flake being secreted above, before the effete one falls away. * * * * *

"As the horse is intended by nature not only to go on level ground but to be able to climb rocks, it is necessary that the edges of the hoofs should be sharp and slightly concave. It must be evident, therefore, that if the edges be blunted and flattened, or still worse, if they be rounded, especially at the toes, one function of the hoof can not be exercised."

Proceeding still more thoroughly into the matter, the author describes in detail the internal structure of the horse's foot and its action. Of the latter he says:

"Now we will see how all these structures, which are apparently so different, can work together in harmony.

"Suppose the animal to be walking. At each step a considerable part of the weight of the horse is thrown upon the frog. The first portion to come to the ground is the

elastic frog, and, as the frog yields to pressure, the sharp-edged wall also comes to the ground, so that the horse is partly supported by the frog and partly by the wall.

"The pressure of the frog is transmitted to the sole, and thence to the wall, which slightly expands. * * * * * "The frog yields vertically and the wall laterally, the rigid sole serving to transfer the pressure. * * * * * Consequently, as long as the animal moves, the horn is never at rest. It is perpetually fulfilling the tasks for which it was made; and is continually thrown off, and as continually replaced. Any interference with nature, therefore, must of necessity be injurious to the hoof."

In testing the expansion of the hoof, Mr. Miles found, "The result was it had expanded one-eighth part of an inch at the heels and quarters; and from the quarters towards the toe this gradually diminished, showing a space of four inches front, and two inches on each side of the centre of the toe, where no expansion whatever had taken place; the tracings proving at the same time that expansion was only laterally, and that none took place in the length of the foot from heel to toe." On the evidence of Mr. J. C. Lupton, a well-known veterinary surgeon, it is proven "that the heel first comes to the ground, is followed by the frog, and that the toe only comes on the ground when the horse is standing still, or when it lifts the foot from the ground."

Chapter IV. is an antithetical statement of the practices of ordinary farriery, and the following summary of this practice is none the less astonishing that they are *bona fide* instructions:

"Pare the sole until it yields to the pressure of the thumb.

"Cut the walls down until they are but little higher than the contiguous sole, taking care to shorten the toe if necessary, it being frequently too long.

"Cut away the bars, so as to make a gradual slope from the wall to the bottom of the commissures, which must be deepened.

"Lower and open the heels, taking the bearing off them for at least an inch on each side of the frog, so that the walls at these parts will not be in immediate contact with the shoe when first put on.

"Pay especial attention to the removal of the 'pegs' (the hard bony substance which grows down at each side of the frog, and contiguous to it). These pegs are apt to contract the foot, or make it 'thrushy,' by pinching and narrowing the frog."

The author takes each of these propositions *seriatim*, and shows the utter fallacy of their logic, and the inevitable injury their application to practice must do the animal. In speaking of the malicious folly of paring the sole, he says:

"It is difficult to persuade many people that the Creator really did know how to make a horse, and that Divine handiwork can not very well be improved by man. But a horse whose hoof is left as nature made it, cares nothing about pebbles, or even broken flint, but can gallop among them without being even aware of their presence, so dense and strong is the crown of the sole;" after which he proceeds to fortify these statements by an instance.

His theory of the cause of "thrush" appears to a medical man very plausible. He asserts that "the disease is wholly owing to the shoe;" and in explanation shows how the action of the venous system (in the horse's foot as elsewhere), depends mainly upon proper muscular play, etc. The shoe checks the growth of the walls of the hoof, prevents expansion, and in keeping all pressure off the frog, nullifies the elastic action of the entire foot. The result, he claims, is a venous congestion in the interior hoof, and a consequent suppurative discharge, which is known by the generic name "thrush." *Foundering* is traced to similar causes.

"Softness of tread," says our author, a few pages further on, "is an exceedingly valuable property in the horse, * * * an unshod horse treading almost as noiselessly as an elephant does, and being delightfully easy to the rider."

[To be continued.]

CONSTRUCTION, EQUIPMENT AND MAINTENANCE OF AMERICAN STREET RAILWAYS.

BY AUGUSTINE W. WRIGHT.

(Continued from page 39.)

IV.

JOINT FASTENINGS.

I have given much study during some years to this question. The ordinary practice of our street railways with flat rails is practically the same that was introduced upon steam railways, with the use of strap rails laid on wooden stringers. Stevenson, in his "Civil Engineering of North America" in 1838, speaks of the practice then in vogue of putting plates under the strap rail joints, through openings in which spikes were driven. The specifications for track laying on the Utica & Syracuse Railroad contained the following: "At each joint of the iron plate (rail) end plates shall be neatly fitted into the oak ribbons (stringers), so as to bring their upper surfaces in the same horizontal plane. The end plates shall be six inches long, two and a half inches broad (same as the rail), and a quarter of an inch thick." This was prior to 1843.

When street railways were inaugurated by the construction of the New York and Harlem in the city of New York, 1832, operated by horse power and laid in the street, it at once became evident that to protect the general public in the use of the street, the rails should be low and offer the least possible obstruction to the passage of vehicles. As other street railways were built the shape of the rail was fixed by law. The rails have, in the majority of instances, been designed to serve merely as a protection to the timber structure. They vary in size and shape. Those most commonly used will be illustrated later. The various forms of joint chair have been above described.

The common practice in this country has been merely to spike the joints, through suitable openings in the chairs, to the stringer beneath. If carefully laid, this method affords a reasonably smooth joint for a time; but the weight of the loaded car presses down the end of the rail upon which it rests, and, no weight being upon the rail next in advance, it projects a little. The car wheel strikes this projecting end, deflects it and wears a trifle from the top of the chair and the bottom of the rail. This action taking place upon the passage of every car wheel, and upon some of the great lines *two hundred and forty* wheels pass in sixty minutes, four per minute, do you wonder that "bad joints" soon result? I have had joint chairs worn down on one end *one-quarter of an inch* in four years.

The spikes become loose almost from the start, and rapid depreciation follows. To avoid discomfort to the passengers, rapid destruction of rails, wear and tear on rolling stock and horseflesh, different remedies have been proposed. Abroad, bolts have been used, passing entirely through the rail, joint chair and stringer, with a broad washer and nut on the bottom. The rails have been extended down at the sides and spikes driven through. Staples have also been used, one leg passing through an opening in the side of the rail and the other into the timber. While these fastenings are improvements upon the spike driven vertically, unless the stringers shall have been thoroughly seasoned they become somewhat loosened by its shrinkage. Condit, in his work on painting, quotes the measurements of Karmarch in Germany on percentage of timber shrinkage in seasoning. "In the direction of yearly rings pine shrinks from $5\frac{1}{2}$ to 12.7 per cent.; white pine 4.1 to 8.13 per cent." If no other objection existed this would suffice, for most track timber is not thoroughly seasoned, and the shrinkage allows a little play at the joint, to be soon increased by wear.

Upon the flat tram rail, the water from rain, sprinkling, etc., follows along the tram, which serves as a gutter, being lower than the adjoining paving, sinking partially through spike holes in the rail, but chiefly at the joint. The recess cut into the stringer for joint chairs, beneath the rails, serves to retain this moisture, and *this* is the first portion of the stringer to become soft and rotten. The load upon each

wheel of a city street car, upon "rush trips," sometimes exceeds *three tons!* This great weight forces the chair into the stringer. If an ordinary spike fastening has been used it does not follow, and the rail end is loose and vibrates under each passing wheel. This is also, in a measure, true if a bolt has been used, passing through the stringer with a nut beneath. The carpenter who cuts into the stringer may have adzed true and level and the chair be "in wind" if of cast iron, or have slight projectures upon its under surface, so that it does not take a firm bearing upon the wood until the weight of the loaded car wheel comes upon it. In such event the joint will soon have play, and rapid wear results. It has been proposed to fasten the rail ends to the joint chair beneath by short bolts, but this fastening, leaving the joint unattached to the timber, allows the whole joint to vibrate under passing loads and wear into the wood.

I patented a joint fastening, as the result of my investigation, as follows: Chairs may be of steel, wrought or cast iron, corresponding in width and shape to the rail. Under the chair two or more nuts are let into the top of the stringer, beneath holes in the chair and rails. The chair is then put in place, on the stringer, over those nuts through which holes have been bored in the stringer of less diameter than the hole in the nut. Suitable openings are provided in the chairs to allow contraction and expansion of the rails. The rails are then placed upon the chairs and a bolt screwed through the nut into the stringer beneath. The nuts fasten the rail ends to the chair, and they are thus held level with each other. The bolt below the nut is screwed into the timber and fastens the complete joint to the stringer.

This construction renders the joint fastening independent of all shrinkage of the timber. Should the chair settle into the stringer from any of the afore-mentioned causes, the nuts beneath carry *both* rail ends with them and no jar results.

I have used several thousand of these fastenings and the tracks are quite smooth. The difficulty with them is that the nuts rust fast to the bolts, and the latter will have to be cut to loosen the rail when the time comes to make repairs. Having sold this patent, I have no pecuniary interest in its use.

In the accompanying drawings, fig. 1 shows my track construction in cross sections; fig. 2 a ground plan; fig. 3 top view of joint chair. The letters all refer to the same parts in each drawing. A is the Chicago rail. Its extreme width is 5 inches. Head $1\frac{3}{4}$ inches at top, 2 inches at level of the tram, and the latter is 3 inches wide. Head is 1 inch above tram. It weighs 45 lbs. per lin. yard. B is the Chicago joint chair of cast iron, 18 inches long, 5 inches wide, and weighing $15\frac{1}{2}$ lbs. C, the stringer; D, the joint screw; E, the nut fastening the rails to the chair; F, opening through the chair for the fastening; G, an additional timber put under the stringer when the rail joint does not come over a cross tie, as described under the head of "stringers." In fig. 3 the lines at H and I show where the rails meet on the chair. The two slots are provided so that right and left chairs may not be required, for, as before stated, two-thirds the length of each chair is placed under the rail against the traffic where cars pass only in one direction. The knees are shown, high outside, low inside of the stringer. The former weigh $7\frac{3}{4}$ lbs. The latter $2\frac{1}{2}$ lbs. The tee rail and all forms of girder rail allowing fish plates afford better joints, a fact referred to in a future page.

V.

RAILS.

The first point to be considered is whether steel or iron should be used.

In the past this has been an important matter, and has never received the consideration its importance merited. My thoughts were first turned to the question when asked by Mr. Climenshaw, of Troy, at a convention of the American Street Railway Association. "You would recommend the use of steel rails, wouldn't you?" I replied in the affirmative, and felt safe in stating that one steel rail would outwear *six* iron rails. I spoke from my experience upon steam rail-

roads; but this question caused me to ponder upon that subject.

The requirements of a rail upon a street railway and upon a steam railroad are quite different, and the experience of the latter is of little benefit to the former. Upon the street railroad, unless the girder rail be used, the rail serves merely as a wearing surface to protect the continuous timber structure. Steam railroads, as ordinarily constructed use the rails as girders to carry the weights superimposed from bearing to bearing, *i. e.*, from cross-tie to cross-tie. They must be sufficiently strong to carry superimposed loads when their heads are worn out. Thus far the requirements of the two systems are entirely at variance. Now for the wearing effect of the traffic. In what does it consist? Dr. Dudley, the accomplished chemist of the Pennsylvania Railroad, has advanced a theory which has been much discussed. Allow me to quote Dr. Dudley, who, upon "The Wearing Power of Steel Rails," said: "The forces that act between the top of the head of the rail and the wheels in rolling friction may, it seems to me, be regarded as two in number. There is first a force, acting directly downward, due to the weight of the locomotive and cars. This force may be regarded as a vertical force, acting perpendicularly to head of the rail, and is in action both when the train is standing still and when it is in motion. Secondly, there is a force acting parallel to the head of the rail, due to the traction or impelling power of the locomotives. In the case of the driving wheels, this force may be supposed to act in the direction opposite to that of the motion of the train. * * * In the case of the drivers, the amount of this force, acting parallel to the head of the rail, is sufficient to overcome the total train resistance; in other words, to cause the train to move. In the case of the other wheels of the train acting individually, this force acting parallel to the head of the rail is small, being only that necessary to overcome the journal friction. The force parallel to the head of the rail acts only when the train is in motion. * * * Returning for a moment to the conception previously mentioned, that the top of the head of the rail and the surface of the wheel are a rack and pinion with infinitesimal teeth, but without regularity in the teeth, let us see what kind of a strain would be produced in these minute teeth by a force acting diagonally to the line of the head of the rail. I hardly see how we can avoid the conclusion that this strain would be a bending strain. * * * If we are right in regard to the nature of the surfaces involved in wear, and the strains produced, wear is simply the breaking or pulling off of the infinitesimal teeth by the strains to which they are subjected. And here we see why it is that the softer rails give the better wear, for the harder the steel the more brittle it is; and the more brittle the steel the more readily will these infinitesimal teeth be broken off by the strains applied."

Dr. Dudley wrote me, December 21, 1885, in relation to this paper:

"We have not studied the subject very closely and continuously since our papers were published in the proceedings of the mining engineers. The observations, however, that have been made since that time strengthen us in the view that the conclusions there are practically correct, and it is our firm belief that ultimately steel rails will be made more in accordance with the formulas then brought forth than at present."

A Pennsylvania engine for passenger service, Class K., weighed, in working order, 96,700 lbs., of which 32,900 lbs. were on the forward drivers. Mr. Chanute made some experiments upon the Erie Railroad. He found that a driving wheel five feet in diameter bore upon the rail head a space not greater than the thickness of a knife blade, about one-quarter of a square inch. Ten thousand pounds being the weight upon this driving wheel, the static pressure equaled 40,000 lbs. per square inch. *This is the great force coming upon steam railroad rails!* It is to stand up under the locomotive that the rails must be designed. It is the locomotive that does the most damage and causes the greatest wear upon its rails.

Now, this force does not exist upon horse or cable railroads.

All the rail has to do in their cases is to resist the wear coming from journal friction, and the latter, together with flange friction, is estimated by M. N. Forney at 6.1 lbs. per ton at a speed of 5 miles per hour. Steam railroads, therefore, need a stronger material for rails than iron, and this is met in steel.

I have used the words iron and steel. What do they mean? It is the same as if I spoke of wood and stone. There are many varieties of each, possessing very different qualities as to hardness, strength, etc.

Iron, when chemically pure, is one of the elements. Its atomic weight is 56, but it is doubtful if it occurs native. Its ores are very numerous, and they vary greatly in quality. In speaking of iron, I mean the ordinary commercial article known by that name, and of average quality and workmanship. A certain amount of carbon changes the appearance and quality of the product. Thurston states: "Steel is variously defined by acknowledged authorities, and the metals known in the market and to the trade as steel can not be completely and satisfactorily classed under any definitions yet proposed. The term includes, as formerly accepted, all impure irons which, in consequence of the presence of other elements, have the property of hardening by sudden cooling from a high temperature, and of taking a definite temper or degree of hardness by a definite modification of temperature, and which may also be forged. It has been recently proposed to define steel as a compound, consisting principally of iron, which has been rendered homogeneous by fusion. Still another definition is iron recarbonized."

Alex. L. Hodey, the father of the steel works of this country, said: "Steel is an alloy of iron which is cast while in a fluid state into a malleable ingot. Any radical nomenclature founded on chemical differences leads to endless mistake and confusion. If steel is defined as an alloy of iron containing carbon enough to harden it when it is heated and plunged into water, then puddled iron, although laminated and heterogeneous in structure, may be steel, and the finest product of the crucible, although crystalline and homogeneous in structure, may not be steel. The fundamental and essential difference between steel and all other compounds of iron, is a structural difference and it is always easily determined, while steel and wrought iron can not always be distinguished by chemical analysis. The same proportions of carbon, manganese, silicon and other elements may exist in and similarly affect any malleable alloy of iron. Steel is, therefore, an alloy of iron which is cast into a malleable mass."

My friend, Col. G. Howard-Ellers, defines steel as "an alloy of iron, carbon and nitrogen, containing a less proportion of carbon in a graphitic or combined condition than is found in carbide of iron, when in the condition of pig metal."

An iron rail is, as it were, made fibrous by the process of rolling. A steel rail is homogeneous, and not fibrous. The iron rails upon steam railroads failed chiefly by lamination. "Lamination," wrote Louis Nickerson, "is the result of some natural and determined law, and that law is this: 'That all material, when subjected to pressure, laminates in planes perpendicular to that pressure.'"

This law was announced by Prof. Tyndall after his experiments upon lamination. Ures' Dictionary of Manufactures and Mines does not agree therewith. It states: "Careful examination convinces the writer that whenever lamination of the rail becomes evident it can be traced to the imperfect welding together of the bars of which the rail is formed." And again: "An objection has been urged against malleable iron rails on the ground that the weight on the wheels rolling upon them expanded their upper surface and caused it to separate in thin laminæ. In many of our large stations rails may be frequently seen in this state, layer after layer breaking off; but this may be regarded rather as an example of defective manufacture than anything else."

Hodey & Colburn wrote: "Rails rarely wear out. They laminate or crush in the majority of instances."

Ashbel Welch, chairman of the committee, reported to the American Society of Civil Engineers, May, 1875, upon the subject of rails, from which I extract: "The chairman

of the committee was so much surprised at so little difference in the loss of metal in iron and steel rails that since the former report was presented he made further examinations. * * * The average loss of metal was, in the steel, 0.29; in the iron, 0.325 lbs. per yard. This shows if iron was perfectly welded, and as hard in the middle as at the top, and never loaded so as to crush or condense the metal (say not over 25,000 lbs. per square inch), it would wear nearly as long as steel."

It would appear, from the above quotations, that the cause of failure of iron rails upon steam railroads, supposing the rails to have been properly manufactured, has been the excessive weights imposed upon them. This is absent from horse railroad tracks, and I am not surprised at the following results as stated by D. K. Clark in his work on Tramways: "Preparatory to deciding upon material—iron or steel—for the rails (Glasgow tramway) of the new system of way designed for hauling by mechanical power, the results of the comparative wear and tear of iron rails and steel rails, under like circumstances, were investigated by the engineers, Messrs. Johnstone and Rankin. Two rails of the earliest sections, one of iron and one of steel, laid in Paisley Road within a few years of each other; and two rails, one of iron and one of steel, laid in Argyle street were weighed when they were laid and when they were taken up. The loss in weight of the Paisley Road rails in 7 years was, iron, 44 lbs.; steel, 43½ lbs.; Argyle street, 6 years, iron, 39 lbs.; steel, 33 lbs."

Steel should be mild. John W. Cloud, of the Pennsylvania Railroad, in the discussion of the paper by Dr. Dudley, already referred to, stated: "We should study the physical properties of steel in relation to its wearing power, and ask the makers to give us the requisite wearing properties, and leave the chemistry to them. The evidence that softer steel does give greater wear in rails is conclusive. At Altoona careful examinations have lately been made of locomotive tires, and from one to two inches difference has been found in the diameters of the tires of wheels upon the same axle. Invariably, when these two tires are put into the lathe, it is found that the tire most worn is the hardest."

Iron glides imperceptibly into steel. It is difficult to fix the boundary approaches upon steam roads.

Upon a portion of the Great Eastern Road, in Great Britain, wrought iron rails wore thirty-three years. Upon the Montreal street railway wrought iron rails have worn twenty-three years.

The coning given to car wheels allows only a very small surface to come in contact with the rail head. M. N. Forney, in his paper on "Rail Sections and Flange Wear," states that the load thus brought upon the rail head is from 40,000 to 60,000 pounds per square inch. This is on steam railroads. The *Railroad Gazette*, November 28, 1884, states "that a cast-iron car wheel, of one of the patterns now largely in use, when running with its flange against the side of a certain rail largely used, has a cross bearing of no more than $\frac{1}{8}$ of an inch in extent. The area of the bearing surface under a 33-inch wheel in such case is $\frac{1}{2}$ of a square inch. With the surfaces between wheels and rails no greater than they now, quite commonly, are, the weight borne by the opposing surfaces is in the case of a fully loaded eight-wheeled twenty-ton car, about 60,000 per square inch."

A prominent car wheel manufacturer tells me that he gives a slope or cone of $\frac{1}{8}$ inch in four inches upon his steam railroad wheels, and $\frac{1}{16}$ inch in two inches for the street car wheels.

As explained under the head of stringers, my stringer top is inclined to equal this coning, and my wheels bear entirely across the rail head. The average load per car wheel upon the North Chicago Railroad is 1,875 lbs., and probably 6,000 lbs. is never exceeded. The average weight, therefore, imposed upon my rail head is 2,600 lbs.; the maximum 16,000 lbs. per square inch. The latter is less than two-thirds the weight considered necessary by Mr. Welch to crush the rail.

The speed upon the steam railroad is another important factor in the wear of its rails. The mud that covers the

head of the street rail in Chicago nine-tenths of the time affords a grit of greater or less sharpness, and our rails and wheels are literally ground out. The life of our car wheel is about half the number of miles that the wheel of the same manufacturer makes upon steam roads, *i. e.*, 30,000 miles. The average loss of metal in our entire steel rail equalled 5 per cent. per annum; but more in the head than in the tram.

It is impossible to adduce statistics of American street railways as to the relative service in tons passing over a certain rail. No company knows or can know.

I could ascertain the number of car wheels that have passed over a certain rail in my track, but *not* the weight upon that car wheel, for I have no means of ascertaining the point along that line at which the different passengers entered or left the car, nor the traffic of public vehicles passing along the rail.

I believe that in adopting steel the street railways simply followed steam railroad practice, without giving the question any consideration; but you have seen that when wooden stringers have been used the requirements of the rail in the two systems are quite at variance. Aside from all questions of wear, human life is not endangered by a broken street rail, passed over with a speed of six miles per hour, as a steam railroad rail at from four to eight times that speed.

I have yet to hear of an American Street Railway Company having prepared specifications for its rails.

Whether of iron or steel, they usually simply invite "bids" from manufacturers, paying the least attainable price and *trusting to the maker to furnish a good rail*. Manufacturers are human. They are not going to do work without a profit. It speaks volumes in their praise that poorer rails have not been furnished. No inspection! No specifications! Simply a reliance upon their honesty.

When the strain upon them has been too great they have yielded. Poor material and inferior workmanship have given wretchedly inferior rails. If, of iron, the manufacturer, looking for some loophole of escape, attributes the failure to anything but himself, and says: "Iron will not stand." "It can not endure the heavy traffic," etc.

I have gone at length into this question, because it seems not to have been considered by street railway officials. It is a dead issue to-day because few iron rails are made and increasing uses are being found for old steel.

I have used nothing but steel for some years, but in attempting to dispose of some that had worn out in less than five years, I found in this market I could obtain from 25 to 50 per cent. more for old iron scrap than for old steel scrap, with many times the demand for the old iron.

No one claims that iron will wear longer than steel, but it seems to me that of average quality the one will wear about as long as the other in street railroad tracks, and iron is cheaper so long as it commands the greater price as old scrap.

The first cost of iron and steel is the same at the present time. The requirements of a girder rail, no wooden stringer being used, are more nearly the same as upon steam railroads, and a mild steel is best.

Wm. Wharton, Jr., A. J. Moxham and others have no hesitation in declaring that from every point of view steel is preferable to iron for street rails.

[To be continued.]

HEAT AND HEALTH.

The people who are so continually clamoring for heated cars, probably have not seriously considered the sanitary aspects of the question. With proper ventilation it will be difficult to maintain the desirable temperature in a car; and cold air is far preferable to foul air at any time. Again, it is a serious question whether it would not be more dangerous to plunge from a heated car into the cold air outside, without additional protection, than to endure continually for a long time, a cold but even temperature. With the coming car-stove there ought also to come hooks along the sides of the clear-story, on which to hang up our hats and coats while riding in the cars.

THE TROUBLE IN CINCINNATI.

A veritable but none the less veritable adage says, that "Nothing succeeds like success;" and the almost universal concession to demands made by labor, as applied to street-car drivers and conductors, upon capital represented in the various street railway companies, has germinated a dangerous feeling within the breasts of employes generally, through all the land, although, to their credit, be it said, that, barring a few notable instances, quietude has certainly prevailed.

Hardly had the echoes of the great trouble in New York died away, when the air was filled with rumors of discontent among street-railway employes, so much so that it threatened to result in a general upheaval. But, amid the roar of battle it is, indeed, refreshing to learn that, in a city so prone to riot as Cincinnati, what threatened to develop into a strike of serious magnitude was averted by each side meeting the other half way, and a judicious display of cool-headed determination and firmness upon the part of the railway companies. The *casus belli* was, as per usual bill of fare in such cases, "More pay for less work."

Under the old arrangement on the city divisions, the pay was \$2 for conductors, and \$1.75 for drivers, for each day of fifteen hours. On the Avondale division \$1.54 was paid for thirteen hours work, and on the Clifton division \$7 per week, for the same working time. The men demanded \$2 per day, twelve hours to constitute a day's work, and threatened to go out on a strike if their demands were not immediately complied with.

At a meeting of the employes, this demand was reduced to writing, and promptly delivered at the office of the Cincinnati Street Railway Company, at ten o'clock on the morning of Friday, the 12th.

Mr. John Kilgour, president of the company, reached his office about that time, and, upon reading the document, at once issued a telephonic call for a special meeting of the Board of Directors. Messrs. Clark, Rogers, Regan and Bullock quickly responded. The doors were closed, and shortly after, Mr. Kilgour emerged and sent Mr. Harris, superintendent of the company, to Workman's Hall, where the employes' committee was in session, with word that he (Mr. Kilgour) would be up directly. The message was duly delivered, and Mr. Harris withdrew. Shortly before eleven, Mr. Kilgour, accompanied by Mr. Clark, vice-president of the company, and Mr. Harris, entered the hall, and in a quiet, business-like manner, without waste of idle words or platitudes, Mr. Kilgour addressed the meeting as follows:

"Gentlemen:—We received your communication this morning. The company has this ultimatum to offer, and if it should not be acceptable, all we ask is that you shall turn the cars in peaceably: We will give you \$1.85 all around, both conductors and drivers, or we will give conductors \$2 and drivers \$1.75 a day, twelve hours to constitute a day in both cases. This is final, and no change will be made in the proposition."

Whereupon, the chairman of the strikers' committee requested that they be allowed twenty-four hours in which to consider the proposition, to which Mr. Kilgour replied: "You can have until Monday morning, if you want it." A member of the committee, rising to his feet, said that the twenty-four hour deal would not work; that they were instructed to turn the cars in at noon if their demands were not acceded to, and that they had no option in the matter. After considerable discussion, it was agreed that all cars should be immediately turned in, so that the men could attend a mass meeting to be held at Arbeiter Hall at two o'clock P.M., to take purpose of taking prompt and decisive action upon the company's offer of a compromise, which was done, Mr. Kilgour not only telephoning orders for the men to attend the meeting, but furnishing cars for their transportation.

By 2 P.M. Arbeiter Hall was filled to overflowing, and it was a curious sight to see a surging mass of men, each armed with a whip or a bell-punch. They were an orderly but determined set of fellows, these drivers and conductors, and impressed the onlooker with an indefinable idea that they meant business. At 2:30 the meeting was called to order

by John H. Hines, who stated that the object of the meeting was to hear and take action upon the report of the committee, which had been deputed to confer with the railway officials. After the members of that committee had taken seats upon the platform, the chairman, G. H. Gilbert, stated what had transpired; what counter-proposals had been made by the company; that as they (the committee), had no power to act, it was for the meeting to decide whether to accept the compromise, or go out on strike, reminding them that they had already gained one point, at least, in the reduction of hours, and unconsciously recommended the acceptance of the company's offer.

Applause followed the committee's report, and Wm. Corbin, speaking on behalf of the men of Mr. Kerper's lines, made some cool-headed, sensible remarks, in which he stated that the boys on the Kerper lines had already compromised at \$1.85 per day "at each end of the car." He recommended a decision which would not only create satisfaction among the men, but also do away with any ill-feeling that might exist towards the companies. He deprecated, in unmeasured terms, drinking, riot, or uproarious conduct of any kind, on the grounds that it would tend to destroy the influence of public sympathy; urged the meeting to decide the issue at once, and closed, amid considerable applause, with a high tribute to Mr. George B. Kerper.

It was a well-made, well-delivered, sober, sensible speech—one to which no exception could be justly taken, no tangible objection offered, and it had a most salutary effect upon the men. It served to demonstrate that their interests and those of their employers were, to a great extent, identical; and it carried conviction to many in whom a bitter "anti-capital" feeling was predominant. The laureate's prediction (amended), that

"The common sense of one shall hold a fretful realm in awe," was fulfilled.

A vote was then taken upon the question in the abstract, "compromise, or no compromise?" 425 votes were cast; ayes 264, nays 161. Then the fun commenced. The next question was, "Which should it be, \$2 for conductors and \$1.75 for drivers, or \$1.85 all around?" The chairman requested that those favoring the first proposition should range along one side of the hall, and those favoring the second upon the opposite side. The knights of the whip were in the ascendancy, and felt elated at the prospect of the ten cents increase, while the punch manipulators felt proportionately gloomy over the fifteen cents reduction. Confusion ensued, which was quelled by the chairman and Mr. Wheton, who took a very fair view of the question, arguing that, as both factions would reap the benefit of a decrease in hours, it would be hardly equitable that one side should suffer a reduction of wages, while the other should gain an increase. This logical *argumentum ad hominem* was like oil poured upon the troubled waters, and the balance of power was transferred to the conductors.

The facetious and irrepressible Wheton created a ripple of laughter, and lots of good feeling, with the happy remark: "If the conductors will set 'em up, we will vote with them in favor of the old wages." Mr. Addison then jumped to his feet and exclaimed: "I see, by the \$1.85 schedule, that a nickel for every car, for each day in the year, will go into the pocket of the company, and they will laugh at us if we benefit them by fighting among ourselves. A standing vote, which was counted with considerable difficulty, owing to the crowded state of the hall, showed the feeling in favor of the old wages, by an overwhelming majority, which result was received with undeniable expressions of approbation.

The men were then instructed to return to work, subject to orders from the standing committee, who drafted the final propositions for signature by them and the presidents of the affected companies.

1. Conductors to receive the sum of \$2 for each day's work of twelve hours, to be paid by the day.
2. Drivers to each receive the sum of \$1.75 for each day's work of twelve hours, to be paid by the day. All extra service required, to be paid for by the hour at the same rate.

Fractions of hours less than one half hour, not to count; fractions of hour's service over one half hour, to count a full hour.

3. No employé connected with the movement to be discharged without sufficient cause not connected with this movement.

4. This to take effect at once.

5. The undersigned committee, on the part of the employés of the Cincinnati Street Railway Company, present the foregoing proposition to said company, this 15th day of March, 1886.

The undersigned, president of Cincinnati Street Railway Company, on behalf of said company, accepts the above propositions, and agrees to comply with the same.

A reasonable time to be allowed the companies to perfect the new arrangement; whereupon, on motion of Frank Mercer, the meeting adjourned.

(The propositions were duly signed.)

It seems strange that, although for a few hours no cars were running, there was no *strike*. The cars had been turned in by order of the *railway company*, and the "malcontents" carried to and from the place of meeting, by courtesy of the "soulless corporation;" if any "strike" did occur, it was on the part of the company, and not upon of the employés. It took but a very few minutes for Mr. Kilgour and his associates to grasp the situation, and they certainly displayed an extraordinary ability to handle such matters promptly. They regarded a reasonable concession to the demands of the men as necessary to preserve the public peace; and remembering the bloody days of *March, 1884*, thought it best to save their city from riot, and even at a cost of many thousand dollars to themselves. And thus do these proverbially "soulless" ones give the lie to the epithet.

On the Kerper lines the men lost but two trips. The proposition was made, accepted and entered into in less than two hours. At 11 A.M. the indications for a full, healthy and able-bodied strike were most favorable; but at 2 P.M. the well-known voice of Bro. Kerper trembled on the telephone wire with "Everything is lovely and the goose hangs high."

E. V. CAVELL.

THE USE OF STRAW.

The following correspondence will explain itself. We publish Mr. Parsons' letter with due apologies for its public use, which we trust he will pardon, in view of the good results aimed at. We discuss the question editorially in another column.

THE STREET RAILWAY GAZETTE,
CHICAGO, Feb. 16, 1886.

MR. JOHN B. PARSONS, Pres. Lombard and South Streets Passenger Railway Company, Philadelphia, Penn.

Dear Sir:—I understand that you are a strong advocate of the use of straw in street-cars during the winter, and being personally familiar with your successful experience as a street railway manager, I am sure that you have good reason for such advocacy.

As the question is one of great interest, at the present moment, in view of the action of the New York City health department in ordering its use discontinued in the cars of that city, we would esteem it a great favor, if you would give us your convictions and experience in the premises.

The special points in interest are, first, the sanitary aspect of the use of straw or kindred materials, and, second, the popular side, i. e., the patronage-drawing power of such practice.

I am yours very truly,

GEO. B. HECKEL, *Editor*.

LOMBARD AND SOUTH STREETS PASSENGER RAILWAY COMPANY, Philadelphia,

EDITOR STREET RAILWAY GAZETTE.

In answer to your first inquiry—"the sanitary aspects of the use of straw in street-cars," I do not see anything that is prejudicial to health—provided proper care and attention are given in its use.

Second, "The drawing power,"—I am decidedly of the opinion that the use of straw in street-cars tends very materially to increase travel,—during the winter season.

Many of the complaints and objections to straw in street-cars is clearly chargeable to the companies themselves. In the first place railroad companies must not go on the

economical plan in the use of straw. It should be removed and renewed every day if necessary. If straw is allowed to become wet or damp, or by use to become very fine, and throw off a dust when trodden upon—it does become objectionable and unhealthy, and under such conditions I do not blame the public to object;—on the contrary, if during the dry weather all fine chaff is swept from the car and fresh straw added, and during wet weather *all* of the straw is removed and replaced by fresh straw, EVERY DAY, the great and main objection to use of straw is removed. I have ridden in street-cars where the straw has not been as clean as the bedding we use in our stables; it was simply filthy, and the public had a right to object. When I took charge of the "People's Line," in January, no straw was permitted in the cars. The mats were saturated with filth and water, and in riding to the depot I was afraid to rest the sole of my shoes on the mat, for fear of contracting a cold. The mats were removed the first night and clean, fresh straw put in. If you could have been in our cars the next morning, and heard the unanimous expression of our passengers, I feel sure, your objections, if you had any, would have been very much shaken. Up to the present time I do not see anything to take the place of straw; wooden mats are objectionable, because they are often dangerous. Ice often forms on them, and passengers slip and slide, and sometimes fall in entering and leaving the car. So far as expense goes, we would be glad to get rid of the use of straw, if we should get hold of a substitute that would suit the public, but up to the present nothing I have seen suits as well as straw.

Respectfully,

JNO. B. PARSONS.

THE STREET RAILWAY GAZETTE,
CHICAGO, Feb. 15, 1886.

MOREAU MORRIS, M.D., Sanitary Inspector, New York City.

Dear Sir:—In our last issue we published an item gleaned from one of our exchanges, to the effect that you have recommended the abandonment of the use of straw in street-cars. As the subject is one of great importance, not only to the public from a sanitary standpoint, but to the street railway companies, in point of economy and popularity, we would be very pleased to have the privilege of presenting your views as a public sanitarian, upon the subject.

I am personally, entirely in accord with you as to the perils attending the use of straw or other absorbent material in public conveyances; but it must be remembered that the public generally demands it, and of two competing companies, the one using straw during the winter, will gain popularity at the expense of its more conscientious rival.

It is my opinion that local prohibitory ordinances will be necessary to suppress the evil in localities where such rivalry exists, and to secure such legislation, authoritative sanitary and medical opinion will be necessary. Therefore, if you consider the subject of sufficient public importance, to spare a portion of your valuable time for its discussion through our columns, I am sure that it must have good results.

The salient points for consideration, as it appears to me, are: First.—Is such use of straw prejudicial to health, and why? Second.—Is hay more or less so, and why? Third.—Would "excelsior" prove an available substitute? Fourth.—Is a bare floor preferable to a straw covered floor in cold weather, and why? Fifth.—(As a supplementary question), what probable effect has the heating of street-cars, upon the health of those who use them?

Yours truly,

GEO. B. HECKEL, *Editor*.

HEALTH DEPARTMENT OF THE CITY OF NEW YORK,
SANITARY BUREAU, no. 301 MOTT ST.
EDITOR OF THE STREET RAILWAY GAZETTE.

Dear Sir:—I have your favor of the 15th inst. With reference to the use of straw or hay in street passenger cars, I would premise by saying, that its use has been discontinued in all of the lines of street passenger cars in this city since the item you refer to was published. That the use of straw or hay in such cars is detrimental to health is, in my opinion, true, for the following reasons: First, if put in fresh and clean on the morning of each day, it takes but a short time for it to become foul by the constant wiping of muddy feet whenever the weather is wet or the ground muddy from thawing; and, further, by the frequent expectoration by the passengers of tobacco juice, and other secretions of consumptives or those suffering from bronchial difficulties or other diseases. That the exhalations from these sources, mixed with fine particles of dust which constantly arise by the frequent stirring caused by passengers getting in and out, must be injurious to health, I think, will hardly be ques-

tioned. Then, when it is taken into consideration that this straw or hay is not changed for a whole day, and becomes more or less thoroughly saturated and filthy, it seems to me that no argument is necessary to convince one of the fact of its unhealthfulness.

Even in dry cold weather, when no mud or dampness might exist, there is yet the befoulment by expectation constantly going on, and the dry particles of dust constantly arising to be inhaled by the passengers. With those suffering from bronchial, pulmonary, or asthmatic troubles, there must be an aggravation, an irritation produced from this source. Asthmatic patients have not infrequently made complaint of this to the Health Department in former years.

Some years since, it was the common practice of all street passenger cars in this city to use straw in cold weather, to protect the feet from cold. Its use then was without any regulation, and frequently complaints were made to the Board of Health of the filthy condition of this straw or hay, which would not be changed for several days in succession. The Board then made the following ordinance in the Sanitary Code:

"Sec. 166. That no straw or hay shall at any time be used or placed on the floor of any railroad car, engaged or used in the business of carrying or transporting passengers within the city of New York, unless the whole of such material shall be entirely fresh, clean and inoffensive in the morning of each day during which the same shall be used or placed on such railroad car, and such straw or hay, when used for the purpose herebefore mentioned, shall be wholly renewed at least once in each day."

This ordinance practically caused the disuse of straw or hay in all the lines of street railroad cars, from that time (1877) until this winter, when a new line in Broadway commenced its use again. Several persons called my attention to it and particularly to its filthy condition, and upon a personal inspection of many of these cars, I found the straw in a most filthy, offensive condition, within about four or five hours after their first starting out from the depot. I then addressed the following communication to the Board:

"The practice of using straw upon the floor of the surface railroad cars in this city, especially during wet and thawing weather, is undoubtedly detrimental to health and dangerous to life for the following reasons:

"As it is the practice, in accordance with Sec. 166 of the Sanitary Code, to place fresh straw in the cars upon their first trip in the morning only, this becomes, during wet and thawing weather, in a short time, filthy and wet beyond description. Passengers are getting in and out of the cars constantly, bringing more or less of wet, snow and mud from the streets, quickly saturating the straw with wet filth, keeping it in a cold, damp, filthy condition, to say nothing of its befoulment by expectation. No better condition could be presented for the nidus of contagion, nor for contracting colds, resulting in pneumonia or rheumatism among those in delicate health, who are obliged to use this mode of conveyance. This filthy condition is much complained of by ladies particularly, whose dresses are frequently ruined by coming in contact therewith, and they also suffer from the cold and wet condition of the straw upon which the feet must necessarily rest.

"In view of the fact that the use of straw or hay in such condition is dangerous to life and detrimental to health, and that its use may be and is superseded by matting or slats—which are comparatively free from such objection—by several of the railroad companies, I would respectfully suggest that Sec. 166 be amended to read as follows: 'To read after the words 'the city of New York,' 'unless the same be kept at all times fresh, clean, dry and inoffensive, the same to be changed as frequently as may be necessary to secure the before-mentioned conditions.'"

The Board held the suggestion under consideration, but without amending the section, notified the railroad companies that the straw or hay should be renewed and changed often enough to insure the health and comfort of passengers.

However, as the newspapers of the city took up the subject vigorously, condemning its use under any circumstances,

the railroad companies using it, immediately discontinued its use entirely, so that practically there was no necessity for amending the ordinance. The pressure of public opinion, as expressed in the newspapers and from correspondents, carried the measure effectually, and I do not think any company in this city will again venture to resume the practice.

I think still that its use should not be allowed under any circumstances, for it is a well established sanitary fact, that particles of dust may be, and are laden with disease-breeding germs. With a hundred people, more or less, there is every probability of some one or more having some communicable disease, which may be transmitted through this means; and as it is possible that such may be the result, and as the only plea for its use is to keep the feet warmer while riding long distances, other means can be provided to secure the same end, without exposing the multitude to the dangers of disease that may be thus communicated. I may be considered radical in this matter, but the light of sanitary knowledge is spreading so rapidly, that sources of disease which, but a few years ago, were almost unknown and ignored, are now well recognized and promptly cared for.

With time to spare and space to fill, I could enumerate and particularize very many conditions that were looked upon with tolerance and indifference but a few years since, that will not be permitted or overlooked for a day at present.

I think I have answered your four points pretty thoroughly, except perhaps concerning "excellent," which, to my mind, is open to the same objections, viz., saturation by wet and filth and somewhat of dust.

The proposition, it seems to me to be, is that floors bare, or covered with the wooden slats, now generally used in all new cars, and which can be kept clean by being easily removed and all dirt swept or washed out at frequent intervals, is the one thing that should be insisted upon. The old principle that the few must, perhaps, suffer for the good of the many, should hold in this case, as it has to do in many others.

Artificial heat can be provided, if the climate or locality of such railroads require some such protection to passengers where the routes may be long. This brings me to your fifth question, about heating effects upon health in street cars.

The frequent opening of the doors in street cars, by the ingress and egress of passengers, allows, of course, frequent change of air, although not to the extent to obviate entirely its vitiation within a heated car; and as we have not yet arrived at the point of perfection in the means for proper ventilation in these small cars, perhaps in your cold climate it may be necessary that such measures should be tolerated, and such means sought for among inventors as would not only heat, but also properly ventilate, at the same time.

Our climate is somewhat different from yours, and I may not, perhaps, appreciate all of your necessities in this case. However, the principles of good sanitation remain the same, only to be modified according to the circumstances.

I have hastily jotted the foregoing reply to your enquiries, hoping that it may answer your purpose. With twenty years' practical study and observation upon all sorts of sanitary questions, a retrospection of the changes and improvements that have taken place during that time appears really astonishing, yet we are almost in infancy in the application of proper means for securing that prevention of disease which is the intent and aim of all sanitary knowledge.

Very respectfully yours,

MOREAU MORRIS, M.D.,

Chief Inspector 1st Div.

HAY IN THE CARS.

Straw is preferable to hay for use in street-cars, because the latter usually carries a great deal of dust and grass pollen which is very irritating to the mucous membranes of the respiratory tracts. It is liable to bring on catarrh; straw, on the other hand has had most of the dust shaken out of it in threshing.

THE
STREET RAILWAY GAZETTE

MARCH, 1886.—MONTHLY, \$2.00 PER YEAR.

COPYRIGHTED MARCH, 1886.

WALDEN, MONROE & CO.,
PUBLISHERS.

GENERAL OFFICES:

NEW YORK, - - - - - 29 Park Row.
Thomas Walden, Resident Partner and Business Manager.
CHICAGO, - - - - - 12 Lakeside Building,
P. G. Monroe, Resident Partner.
E. V. Cavell, Business Manager.

George B. Heckel, - - - }
R. Grimshaw, - - - } Editors.
Henry C. Lockwood, - - - }
J. D. Nolan, - - - }

BRANCH OFFICES.

Philadelphia, Pa., 105 N. 4th St., J. Waterkeyn, Manager.
Pittsburgh, Pa., James Longhran, Manager.
St. Louis, Mo., 709 Olive St., Frank Trainor, Manager.
Atlanta, Ga., 68 Alabama St., Chamber of Commerce Building,
William Minningerode, Manager.
St. Paul, Minn., 558 Drake Block., V. R. Benham, Jr., Manager.
San Francisco, Cal., 320 O'Farrel St., G. W. Fairchild, Manager.

Owing to the absence of our editor (partly due to the strike in New York demanding attention) our issue for this month has been delayed.

THE PUBLIC FOOL.

The present great interest manifested by the public in the history and future of the Broadway (New York) railroad calls forcibly to mind the opposition and apathy the enterprise encountered when it was first projected. It is said that this road has been Jacob Sharp's pet hobby for many years past, and we all know how he worked early and late, here, there and everywhere, to secure the franchises. We also all know how press and public were arrayed against the "desecration" of Broadway, and how the more conservative, echoing Napoleon the Great, "wanted no new-fangled Yankee notion" in Broadway, shuddered with religious horror at the idea of wiping out such an antique institution as the Broadway stage, and did not want horse cars at any price; and how even the most progressive of the inhabitants feared the inconvenience of cars and tracks on Broadway. Nevertheless, the tracks came (how or why, we are not bound to judge, and are not much interested anyway), and now, behold, every one that had a chance to help along the enterprise and did not, is mad at all the rest who did, and wants to see the charter annulled and the incorporators investigated, etc., etc., but there is not a man, woman or child in all the large city of New York, who is not pleased to have the railway in Broadway. Verily, the public is a fool.

STRAW IN STREET CARS.

It is a little surprising to an outsider to observe the diversity of opinion and practice concerning the use of straw, hay or the like in street cars; and it is a question upon the merits of which the association should be able to pass authoritatively, and so settle the custom.

Either of two facts, straw is or is not desirable in winter. If the former, then those within certain geographical limits who do not use it fall short of an easily reached mark of excellence;—if the latter, then there is a lot of money expended uselessly or perniciously every winter by street railway companies in nearly every northern city.

The sharp contrast of opinions existing was called strikingly to our attention by two items published in our February number. One of these was a passage in the account of

the sale of the People's Line, in Philadelphia, in which it was stated that as soon as the new management assumed control, "one of the first changes made was to order that straw be put in all the cars of the People's Company. * * * This order was carried out. President Harrah did not allow the use of straw in the cars."

The other item alluded to was printed among our New York City "Pointers" in that issue, as follows:

"Dr. Morris, of the Health Board, has recommended the exclusion of straw from the street cars. The Broadway road people say it costs them \$60.00 per day for straw, and that no clean straw is used. Nevertheless, the company proposes to substitute for the straw, wooden slats, which will be placed in the cars as fast as they can be manufactured."

In Chicago also there has been some complaint against the South Side road, for taking the straw out of its Cottage Grove avenue cars, while in the opposition a local wit has satirized its use in the following widely quoted parody:

When riding in the street-car cold,
The warmth I sadly needed;
No glowing fire could I behold,
Although I vainly pleaded.
What do you think they gave me?
Oh, hay, mamma! Oh, hay, mamma!
What do you think they gave me?
Oh, hay, mamma! Oh, hay!

Our own opinion is that in dry cold weather clean straw, or better still, "excelsior," frequently changed and never used over, is a very comfortable adjunct to a horse-car; it acts as a non-conductor on the floor and helps to keep the feet warm. In damp or muddy weather, however, we think any thing of the sort positively dangerous to use; there are so many varieties of disease germs for the propagation of which just some such element as moist, filthy straw is needed, that if such germs chance to lodge therein they are sure to increase and multiply. Of such are diphtheria and scarlet fever; and while it is not yet positively established that these are germ engendered diseases, the probability is too strong for us to afford any risks. Then again, we have pneumonia, bronchitis, and the kindred mucous diseases, about which there is no doubt whatever of their being fostered by precisely such conditions as damp straw and dusty exhalations from the same; so that altogether, leaving out of the question the infectious diseases, the remaining peril is sufficient to make us wary of the continual use of straw. On the other hand there is, as we have said, no doubt that dry straw is a great adjunct to comfort on a cold day, and that its liberal use helps a street railway company to popularity. This has been proven by Mr. Parsons' experience, first with the Lombard and South streets line, and since with the People's lines, in Philadelphia. The latter we have had an opportunity to inspect since the change in management, and we must admit that the change from the continually wet and filthy cocoa mats, to fresh, dry straw is a decided improvement, and of course the objections to straw apply in a measure to anything which will absorb and retain moisture, including mats of cocoa or other fibre.

To wooden slats there are two or three obvious objections. Among them their liability to become glazed with ice, or slippery when only wet and not frozen.

Of course, it is more than anything else an economical question with the railroad companies, and looking at it from this standpoint, it is probable that of two competing lines, the one using straw would receive more patronage than the one which ran its cars with bare floors. Nevertheless, the public is not made up of sanitarians, and its selfish idea of comfort is not likely to be a safe guide to practice; wherefore it behooves those who serve its needs to use due care that in gratifying also its wishes, they do not work it an injury. If, as Dr. Morris insists at another place, straw is always dangerous, its use should be abandoned universally, and while the companies alone may not be able to cope with the public prejudice which may demand straw in the cars, it is their duty to see that such ordinances shall be passed by those who make the local laws, as shall effectually settle the question, and at the same time protect them from the results of ignorant prejudice.

Mr. Parsons also speaks upon the subject, and the case

he makes is a strong one, for he bases his arguments on a long and successful experience. We have suggested "excelsior," and rubber mats as desirable substitutes, and not considering the first cost of the latter, think that nothing more cleanly or more wholesome could be found. However, the straw question may be considered still an open one, and the Lombard and South streets company, in Philadelphia, certainly exercises the greatest possible care in keeping the material in its cars as far as possible, always fresh and clean; but everyone will be ready to admit that if something else be found preferable from a sanitary standpoint, the abandonment of straw would also save a great deal of money to the users.

HECKEL.

A STRIKE AGAINST THE PUBLIC.

During the excitement of the recent strikes in New York we have heard a great deal about the rights of employer and employé, but little of the rights of the public, for whose benefit these roads were built. It seems to us that this feature in the contest has been almost lost sight of. The franchises are peculiarly public ones, and were granted for the purpose of extending the facilities of travel to the toiling masses and in the interest of the business community. So essential to the welfare of the people is the regular and efficient service of the railways regarded in some parts of Europe, that the Government has taken their management in charge. In this event the employés become public officers. In a certain sense the employés of our city roads may be regarded as public servants. The strike of the operatives of a manufactory might bring serious inconvenience to a small part of a community,—but a railway strike is a public calamity, and a blow at the Government itself. It is a specie of revolution, and if there is not a stop put to these senseless movements there will be a return to barbarism, or to a condition of things very like it. We suppose if any one should charge the Knights of Labor with instituting a strike against the public, these gentlemen, with characteristic names, would indignantly repudiate such allegation as false. Notwithstanding such denial, it is quite clear that there was not any good reason for the general strike of the companies in New York. The movement was sensational and revolutionary. The order came to all the lines of the city "to stop work until all grievances are settled to the satisfaction of your brethren in the Dry Dock Roads, and the roads of the Atlantic Avenue Railroad Company, of Brooklyn." The whole community of this city is put to an immense loss and inconvenience because a small line had a difficulty with its employés. Could there be anything more illogical or unjust? This high-handed course has simply created a public feeling and sentiment against those who bring about these unlawful labor movements, and this outrage against common decency will tend to awaken latent perceptions of law and order. The question fast entering itself on the public consideration is whether the good people make laws in our legislatures or the Unions promulgate them by proclamation; whether we live under the rule of secret societies or of open legislatures; whether we are governed by a small body of men or the majority of the people as expressed in the forms of law. If we are successful in finding out which one of these bodies is entitled to pass laws, then let us enforce them, for nothing demoralizes a community more than to leave the law of contract and of order to fall into what the President calls "desuetude." A railway is a public institution, and is entitled to be protected "by the entire power of the law and of its executive officers and servants against unlawful interference and molestation."

The questions that underlie the considerations of labor and its relation to capital are very technical and difficult of solution. It is doubted whether the leaders in these labor movements are sufficiently learned in economics to form any correct idea as to the best course to take in order to benefit the masses. Combination of itself is not wrong. There is already evidence that the Knights have often thrown their lances at symptoms rather than diseases. Let all the questions involved be openly discussed. Let the fundamental principles of economical law be studied and

investigated. Let the workmen understand that if capital becomes timid, the chances of employment are lessened. The last census of the United States showed \$2,800,000,000 invested in manufactures, and that this gave employment to 2,000,000 men, women and children. In other words every \$100,000 properly invested, supported by employment about 100 persons. Thus, every man who withdraws this amount takes away the bread of one hundred persons. Lawless costs the laboring man more than the capitalist, for the latter may seek new ways of investment.

It would almost seem that there are those who are in favor of returning society to a state of barbarism. We are supposed to live under a free government where a love of industry and of order exists. If we do, let us put an end to the rule of the conclave. LOCKWOOD.

"DUMMIES" AND OTHER MOTORS.

That veteran street-railroader, Mr. John Stephenson, of New York, contributes to the history of "dummy" engines and other mechanical motors for street railways, the following chronological table:

Mr. Stephenson was interested in the first experiments in this line which were made between 1832 and 1834, in New York. The New York and Harlem Railroad (Fourth avenue) having been in operation for two years with horses on the lower end of its road, and finding that they could not successfully compete with omnibus time, then on the Third avenue, commenced the era of steam motors, made by Wm. T. James, of New York City, and such efforts with modifications of motors were continued about four years.

In 1860, the Second avenue Railroad Co. commenced operating the upper end of its road (3½ miles) with cars having the steam motor in the front end of the car, in an apartment separate from the passengers, which in about twelve months was changed to the system of independent motors, which were increased to heavy engines and steam road cars (eight wheel cars). This era of steam occupied about six years, and was then abandoned.

The Market-street road of Philadelphia adopted steam motors in 1876, continuing them about one year.

Brooklyn having many roads reaching to the sea shore, very largely adopted steam motors in 1877, but all, or nearly all, were abandoned within five years. Various efforts were made to use compressed air engines; also water heated to a high degree, giving off vapor under pressure; also springs compressed—electrical engines and gas engines, with all of which we have been familiar, but failure only has resulted.

"(1883). England has been for fourteen years vigorously pushing such experiments regardless of cost, but with no better results, and the French efforts may be summed up by the following quotation from a recent report:

"After an experience of five years and exhaustive tests of twenty-one different systems, the Paris Tramway Co. has abandoned the use of steam, and reverted to horses as a cheaper and in all respects more satisfactory motive power. Scarcely a week has passed without some accident on the steam lines, which proved costly to the company and led to complaints from the public. At last the authorities forbade the further use of steam, and the railroad company was perfectly ready to acquiesce."

Mr. Stephenson sums up with the following opinion:

"To the above may be added, that an ordinary tramway plant is not sufficient for such use, but is soon destroyed, because of the weight of motors (from 12,000 to 20,000 pounds) in addition to the wriggling motion of the engines."

"We regard the question as fairly settled, that no mechanical motor is yet in sight to take the place of animal power in propelling street cars.

"To this conclusion may be excepted in part the cable system, which has only developed superiority on grades, where animal power could not be used. The heavy first cost of the cable system with its complicated machinery, subject to accident, causing delays, widespread inconveniences and loss, are serious drawbacks, for which remedy has not yet been found."

CAPT. BONFIELD.

The following self explanatory letter has been received by the Honorable Carter Harrison, Mayor of Chicago :

CHICAGO, Jan. 23, 1886.—*To the Hon. Carter H. Harrison, Mayor of Chicago*—DEAR SIR: As you are already aware from previous interviews and communications, the Trade and Labor assembly of Chicago has appointed a committee of seven members to inquire into the truth of the alleged brutality of Capt. John Bonfield during the recent street-car strike on the west side. This committee have exerted themselves by every lawful means to secure a fair and impartial investigation of these reports, but so far, by reason of the manifold obstacles thrown in our way by city officials and employes, have been wholly unsuccessful. The work assigned to this committee, purely humane as it is, affords no financial profit, but, on the contrary, involves the assembly in considerable expense; and the only possible pleasure to be derived will come from a consciousness of having done all that was possible to promote justice, to redress the wrongs of a number of workmen whose position in life is too humble and lowly to procure redress without such assistance, and to redeem the city and the faithful members of the police force from the charge that one of their number was guilty of great inhumanity, and, if guilty, to remove him summarily from their presence. In addition to these inspiring motives we had thought Capt. Bonfield would be glad to avail himself of an opportunity to silence former allegations of cruelty such as the civilized mind associates only with savages.

You have already expressed to this committee an unwillingness to believe the statements under oath of the witnesses we proposed producing, and, as we are reluctant to impose upon Chief Ebersold the duty of sitting in judgment on one of his nearest associates, and, as an earnest of the assembly's disinterestedness in pursuing the investigations, the following proposition is respectfully submitted:

That you or Capt. Bonfield select one of the ex-judges of a court of record of Cook county, this committee to select another, and the evidence to be submitted to them in writing or otherwise, as they may decide, and, if unable to agree, they to select still another such judge, and all interested to waive all legal rights and formalities and agree to abide the decision so rendered.

This, we take it, would be the simplest, speediest and least objectionable plan for the settlement of this matter—one in which every citizen of Chicago should be as deeply interested as the Trade and Labor assembly—and we hope to receive an early and favorable reply. We have the honor to be very respectfully yours,
LEO. P. DWYER, Chrm.
WM. HOLLISTER, Sec'y.

Special committee on behalf of Trade and Labor assembly.

As the clown says when he turns a "flip-flop" into the ring, "Here we are again." Too bad is it not that the entire official force of Chicago is combined to frustrate the demands of justice, and that the humane and altogether philanthropic and expensive work of the special committee should be so much "sweetness wasted on the desert air." Awful, so it is, that the Mayor and Chief of Police will not step down and out, and allow the special committee to run the police of Chicago!

But seriously this farce has gone far enough. Now, Messieurs Trade and Labor assembly (special committee included), stand up! Don't you know that instead of rushing around and seeking to have Capt. Bonfield "bounced," you should "chip in" and buy him a gold medal and a silver-mounted club?

Why?

Because he saved the lives of your friends!

Which friends?

Why, the parties engaged in riotous proceedings during the street-car strike!

How do we know they are your friends?

Because you have taken such a philanthropic and expensive interest in them, while for those who were hurt on the other side, you have never a word, never an expense, never a philanthropy.

Well, even if this be so, how did Capt. Bonfield save their lives? By his firmness and general bravery, and by the judicious though vigorous use of a little of the "oil of locust" put at the right time, he averted a general riot.

Do you not know that on that July day it was a grave question whether the militia would not be the next actors in the drama? Would you have preferred bullets to batons? Of course not! Gatlings, to clubs? Of course not! The "Charge bayonets, forward," of the soldier, to "The fall back there, men," of the police? Of course not! Well, that is what Capt. Bonfield saved you from that day; so, now go to your seats like good boys, and at recess take up a collection for Bonfield and buy him that medal and club!

MONROE.

THE GREAT STRIKE IN NEW YORK CITY.

In our last issue we gave the details of the preliminary troubles of the New York railroad employes with the various companies, and the partial settlement of the difficulties reached at that time. Simultaneously with the demands then made on the companies, a similar petition was presented to the Dry Dock, East Broadway & Battery Railroad Company, to the effect that the working hours of the drivers and conductors on all of the four lines of the company be reduced to twelve hours a day. It was further specified that the men should be allowed forty minutes for dinner and that their wages should be \$2 a day. President White refused to receive the petition and remarked that he would not entertain any such demand, nor would he discuss the matter with the committee or any other labor organization, as there were twenty-four cars on the road then running under the twelve-hour rule, and the drivers were allowed ten minutes for dinner, which was the best that could be done for them. This answer was reported to the Car-Drivers Assembly, but further action was deferred in the hope that the petition would receive some notice from the directors of the road. The day following, it is claimed, three of the oldest drivers on the line were told that an effort would be made to accommodate the schedule time to the wishes of the men. Before the new table could be made out, the Car-Drivers Association decided to declare a strike, and this reaching the ears of the directors of the company they advertised in four daily papers, Sunday and Monday mornings (28th ult. and 1st inst.) for conductors and drivers. In answer to this several hundred men called at the offices of the company, and between seventy and eighty men were engaged.

Upon learning of this move on the part of the company, a meeting of the car-drivers was called, which resulted in ordering a general "tie-up" beginning at four o'clock A.M. on the 3d inst., over all the company's lines running from Grand Street Ferry to Cortland Street Ferry; from Grand Street Ferry to Desbrosses Street Ferry; from Thirty-fourth Street Ferry, East River, through Avenue B to City Hall, and from East Twenty-third Street Ferry through Avenue D to City Hall.

Accordingly when the 4 A.M. car reached the stables on Tuesday morning, the conductor and driver stepped off the platform, and the horses were taken to their stalls, similar proceedings being taken with each arriving car, and when the last car on the road had been run into the stables, the drivers, conductors, carpenters, painters, stablemen, horse-shoers, pavers and water-boys—in all about 750 persons, formed in line and marched to the Eleventh Ward Hotel, on Third street near Avenue C, where they were received by a committee of six members of the Knights of Labor.

Later in the day a committee was sent back to the stables, and soon succeeded in capturing most of the newly engaged substitutes.

President White, being ill, delegated the management of the difficulty to Mr. Wm. Richardson, a director of the road and president of the Atlantic Avenue Co., in Brooklyn.

Meanwhile the striking employes held a meeting in Clarendon Hall, where they were addressed by J. T. McKechnie, secretary of the Central Labor Union. Determined to carry to the farthest possible extent the injury to the obnoxious company, a dispatch was sent to the Governor of the State, to the effect that no cars were running on either of the road's four lines, and requesting him to take action; it being determined, if possible, to prevent the running of cars for twenty-four hours, and so secure the abrogation of the company's charter.

Mr. Richardson, on behalf of the company, presented a new schedule agreeing to call twelve hours a day and pay the men \$2, as demanded, but refusing to give the "trippers" \$1.50 for one quarter of a day's work, as demanded.

Commissioner Kernan arbitrarily ordered the company to commence running its cars at once, or he would report the matter to the Attorney General with the request that its charter be taken away. He refused to accept the plea that the company was not at fault, and plainly showed his bias in favor of the strikers.

Mr. Richardson and Superintendent White both stated decidedly that they would not accede to the demands of the strikers, and should proceed to hire new men at once if an understanding was not arrived at by the fourth. Accordingly it was determined by the company to run a car at all hazards on the following day, and as the strikers were equally determined to prevent it, Captain Murray, anticipating grave trouble, sent a squad of 120 policemen, under command of Inspector Steers, early in the morning of the 4th, to the company's stable in Grand street. Almost at daybreak, crowds, consisting principally of strikers, began to assemble here, until they extended in a dense mass along Grand street, from East River to the Bowery. Reserves, posted along the route, managed to maintain fair order.

Everything remained quiet until 11 o'clock, when President White told Inspector Steers he intended running a car over the Grand street line, and the latter, promising to see it through, a car was started at 11:10. It was commanded by a conductor and driver, under the guard of four policemen, and escorted by a squad of twenty officers, under the personal command of the inspector. The mob howled and threw stones, and the Captain after cautioning his men to use the club sparingly, charged and drove back the crowd: and so the car was taken slowly to Goerck street. Here a car of the Forty-second street line was met, and the mob seized and threw it across the Grand street tracks. It was soon removed, and the car went on, but in the middle of the block a number of trucks had been seized and formed into a barricade, which also the police removed. Assistance was telegraphed for, and soon the reserves began to arrive and affairs were looking serious. From this point to East Broadway the obstructions were continuous, but the car finally reached that street. Here, however, the switch plate having been removed, the horses were turned, and the car run back without hindrance to the stables.

Shortly after 12 o'clock, Police Superintendent Murray arrived and took command of the reserves, of whom there were said to be fully 750 in line. The mob had also increased to dangerous proportions, and the members of the Executive Board of the Empire Protective Association (the striking organization) went continually about among the crowds, urging against violence, but asserting their determination to prevent the running of a car over the line.

At 2:30 a second car was run out of the stables. A squad of 100 policemen, with drawn clubs, preceded it. Four policemen guarded the platforms, and twenty supported it on each side, while Supt. Murray followed with a command of 150 men. No serious obstacle was encountered until Allen street was reached, where a Christie avenue car arriving at that moment, the horses were unhitched and the car was placed across the tracks. A mob leader was arrested and taken away. The crowd then made a rush for the Bowery, and two cars of the Third avenue line were captured and overturned. The stove in one of them set fire to the car, the fire department was called out, and soon the street seemed impassably blockaded. At the same time a rush was made for Broadway, and five cars of the Fourth avenue line were captured and overturned on the crossings. Meanwhile the police were active in making arrests.

During this time Inspector Steers was working with his force towards the scene of disturbance. As they reached Allen street a fight was made over the possession of a Second avenue car, and the clubs were used freely. However, the way was finally cleared to Christie street, where a second fight was made over the clearing away of several more overturned cars. A number of the mob were injured in the mêlée; but the Broadway blockade was cleared. From this point to the end of the line the police were kept at work clearing away the barricades, but it was accomplished.

The return trip was but a repetition of the same struggle, the car was stoned, and at the Bowery it had to be lifted around a barricade. But the stable was reached in safety, at about 4:30.

The Sixth, Seventh, Eighth and Ninth avenue cars were blocked for half an hour, and the Broadway cars for two hours.

At six o'clock the police began to disperse the crowd, and soon all was quiet.

THE BROOKLYN STRIKE.

During the progress of affairs in New York, the Empire Protective Association decided upon a flank movement against Mr. Richardson, and, accordingly, on the third night, at about six o'clock p. m., all the seven lines of the Atlantic avenue railroad ceased running. The "tie-up" was manifestly well-timed, as it was in the midst of the heaviest rush of the day. As each conductor arrived at the depot he abandoned his car, made his customary report, and announced himself "off for the present." As a notice had already been posted in the company's office acceding to the demands of the men, this strike was a self-evident attempt to enforce a boycott against President Richardson.

During the night the striking employes held an all-night meeting, and during the night messages passed between the company and the strikers requesting conferences, but each refused to wait upon the other. At eleven o'clock on the ensuing day the following points were submitted by the executive board to President Richardson as a basis of settlement:

Twelve hours and half an hour for dinner; wages, \$2; seven trips on the Fifth avenue line, seven on the Seventh avenue, seven on the Bertram street, eight on the Bergen street, nine on the Butler street, six on Vanderbilt avenue and eleven on the Crosstown; no trippers on the Butler street for less than six trips and at the rate of \$1.50 per day; extra trips to be paid for at the rate of \$2.22 2-9; trippers on the Bergen street to make not less than five trips at \$1.50; extra trips twenty-five cents each; Crosstown trippers, eight trips for \$1.50; extra trips, 1½ cents each; stablemen and hitchmen, \$12.25 per week, twelve hours work daily, with an hour for dinner and one for supper each day; stablemen not to take care of more than eighteen horses. Watchmen \$2 for day or night. Truck drivers, ten hours, no Sunday work, wages \$2; the companies to furnish everything necessary for the cars; drivers and conductors not to be compelled to clean their cars inside or outside; horsehoers, \$3 per day and the contract system abolished; towboys, twelve hours and \$1.25; that Joseph Hull, transfer agent; Benjamin Hendrickson, foreman, and Samuel Hegeman, starter, be reprimanded for using abusive language to the men; that starter Jackson at the bridge be removed for ill-treatment of the men; that drivers be not compelled to hitch or unhitch their teams, and that changers bring out the teams; and, lastly, that no employe be discharged for belonging to any organization or taking part in the present difficulty; all discharges to be subject to investigation by the executive board of the Empire Protective Association.

Very promptly Mr. Richardson sent back this answer:

"GENTLEMEN—Your communication of this date is received, and has been carefully read. In reply I desire to suggest a much shorter and more explicit way of presenting your demands. It is this: That you demand the resignation of the president and directors of the Atlantic Avenue Railroad Company of Brooklyn, and that hereafter its railroad lines shall be in charge of, and its business controlled by, the executive board of the Empire Protective Association of the State of New York.

The committee replied:

STR—On behalf of the Empire Protective Association of the State of New York, the executive board demands the resignation of the president and board of directors of the several lines under their control. We do this for the benefit and convenience of the patrons and citizens living in the vicinity of the Atlantic avenue company's roads. The intelligence and discipline of railroad employes since they began the twelve-hour movement proves that the citizens would be safer in their hands than in the hands of such men, who answer an intelligent demand by a display of ignorance and incapacity to treat sensibly a grave matter of public interest.

In the meantime an attempt was made to run a car out of the Third avenue stables, but the driver was induced to abandon the attempt.

At about four o'clock a squad of 100 policemen, under Inspector MacKellar, arrived at the stables and cleared the street immediately in front of them. A few minutes later a car came out, with Mr. Richardson standing on the platform beside the driver, and several policemen inside. The car was headed for South ferry, a mounted police-sergeant riding in front, and five mounted patrolmen on each side, and a foot force outside to keep back the crowd.

When the car had gone a few feet a large truck filled with men was driven on the track and stopped in front of it. The police rushed to the heads of the horses and forced them out of the way. No further difficulty was encountered until just below Clinton street, where barrels of ashes had to be removed. At South Ferry the car was switched to the

up track and started on its return trip. At Hicks street a "bob-tail" car of the Crosstown road came on the track in front of the Atlantic avenue car. A gang of men seized and turned the car partly around. Some one cut the traces and the police were crowded away from around it. They made repeated efforts to get it back, but failing in that, it was finally run off the track, while Mr. Richardson and his car went forward. Meantime a truck got on the track in front of the car, and the driver refused to turn off. Sergeant McNamara jerked his horses' heads around and with the use of their clubs the police compelled the driver to get out of the way. The same truck returned to the track at Boerum place, and the police got in it and drove the men off with their clubs. No other serious attempts were made to hinder the car, and it went as far as the Long Island Railroad depot and then returned to the stables. After the car had been put back in the stables the policemen dispersed the crowd.

Simultaneously with this successful attempt by Mr. Richardson, his son, the secretary of the road, and Vice-President Frost, who had gone to the stables at Fifth avenue and Twenty-fifth street, made an effort to start a car there and divert attention to that point. About 4 o'clock a car set out with Mr. Frost on the platform. Captain Murphy and ten policemen were on hand. The car had only gone a few feet when a florist's wagon was driven in front of it and some old rails were placed upon the track, together with marble mantels, gravestones, and blocks of uncut marble and granite, forming an impassable obstruction. As soon as the car stopped the horses were unhitched and led away and the driver and conductor were hastily taken off the car. The conductor was knocked down, but not seriously hurt. One of the horses was also knocked down. Captain Murphy stepped off the platform of the car and ordered his men to use no violence, despite the fact that stones were thrown at them. The car was then put back in the stables. Two other unsuccessful attempts had been made to start out cars with the same driver and conductor earlier in the day. No further attempt was made at running cars during the day, the provisions of the charter having been secured.

There was a temporary "tie-up" on the Prospect Park and Coney Island road, which, for a short distance, uses the Atlantic Avenue Company's tracks, but on learning that the former company had recently increased the pay of its employés to \$2.25 per day, the strike was raised.

In reference to the occurrences of the day, Mr. Richardson said:

"This strike was wholly due to my action in New York, and there I only performed my bounden duty as an officer of the road, which I could not have neglected without being guilty of the most abject cowardice. As chairman of the executive committee of the Dry Dock, East Broadway and Battery Railroad Company, I was the acting president in the illness of the president. We had practically granted the demands of the men, and then they made further demands and ordered a strike. I think that the men will accept the \$2 for a day of twelve hours and let the officers of the companies manage the incidental details. If this is not done all the companies of the two cities must unite for the maintenance of their rights. This is as good a time as any for the settlement of the question, whether property is worth anything to those who own it, or whether the reign of communism in this country has begun."

THE GENERAL "TIE-UP."

March 5th.—The blood was now up on both sides, with the advantage of victory with the Dry Dock Company, and the moral support of the railroad commissioners (who were probably not averse to forwarding their political future) with the strikers. On the evening of the 4th the latter held a prolonged secret session, and finally issued the following order:

"To all the local assemblies and the members in this jurisdiction in the city of New York, greeting: Brethren—You are hereby ordered to stop all work, in whatever capacity employed, to-morrow at 4 o'clock a.m., and to remain out until all grievances are settled to the satisfaction

of your brethren of the Dry Dock road and the Atlantic Avenue roads in Brooklyn, the same to be approved by the executive committee.

"JOSEPH O'DONNELL,

"ANDREW D. BEST,

"JOHN HUGHES,

"WILLIAM WALLACE,

"Committee."

Consequently, after the night cars had reached their respective dépôts not a street car appeared in all the great city. However, men had been detailed by the committee to attend to the feeding and watering of the horses, though they were in no instance assigned to the roads by which they were ordinarily employed.

During the morning Commissioner O'Donnell had an interview with the association committee, who washed their hands of the violence of the previous day and agreed to submit the differences in point to his arbitration. The commissioner then drove to Mr. Richardson's office, and, after a short consultation, received the following from that gentleman on behalf of the directors:

To JOSEPH O'DONNELL, Chairman Executive Board, etc.:

Resolved, That the Atlantic Avenue Railroad Company of Brooklyn agree to pay at the rate of \$2 per day the conductors and drivers for twelve hours' work, including at least one half an hour for dinner, and after our cars are running to leave all other questions relating, to conductors and drivers to Railroad Commissioner O'Donnell; the Dry Dock, East Broadway and Battery Railroad to be subject to the same decision as the Atlantic Avenue Railroad Company.

WILLIAM J. RICHARDSON.

In consequence of this action, at 3:10 p. m. the first car started out of the Grand street depot, and shortly afterwards all the lines in the city, excepting those of Mr. Sharp, were running regularly.

A few days later the propositions of the Empire Protective Association were accepted, with the exception of that governing the discharge of an employé, which, in the original series of proposals, provided that when a man was discharged the reasons for it were to be laid before the executive committee. This has been modified so far that when a man is discharged for cause the reasons for his dismissal shall be given in writing and signed by the proper officers of the company in whose employment he was. The discharged man is at liberty to appeal to the executive committee or to submit to the decree issued against him. The reasons, if found frivolous, may be a matter of conference between the company and the executive committee.

Mr. Sharp held out a little longer, and on the 6th instant a Twenty-third street car had to be taken across the town by the police, but at 6 p. m. the disputes were settled on a basis similar to that accepted by the other roads.

At another place we publish an editorial commenting on these occurrences, and little needs to be added here. There is no doubt that workmen have the moral and legal right to refuse to work, if they so choose; but, on the other hand, no one has a right to destroy property to enforce his demands, or to use the innocent as a cat's paw. The strike leaders deny all responsibility for the disorders attendant upon the strike, but the fact stands that but for the strike there would have been no violence. They also stultified themselves in advising peace and at the same time expressing their determination to use force to gain their ends. In the beginning the public was with them to a certain extent, but their actions on the 4th inst. alienated the thinking part of the community, and the malicious move against the Atlantic avenue lines, in the face of concessions already made, was absolutely unjustifiable. There is a dangerous element in the results obtained, whatever may be their present status, and the commissioners may yet live to regret the part they have taken in this dispute. H.

SALE OF THE NORTH CHICAGO RAILWAY.

On the 25th inst. C. T. Yerkes of Chicago, acting for the Drexels of Phila., who, in turn are the financial representatives of a syndicate in that city, bought for \$1,750,000 cash, the interests of V. C. Turner, Pres., and his relatives—1,786 shares, and Jacob Rehm, V. Pres., 719 shares, which gives the new holders 55% of the stock of the N. C. Ry. Mr. Yerkes has been elected president and Mr. Rehm will for a time remain with the road.

POINTERS.

ALABAMA.

Anniston.

The Anniston Street Railway Company, with a capital stock of \$200,000, has been incorporated by A. L. Tyler, Samuel Noble, John W. Noble, Wm. Noble and John M. Caldwell, who purpose to construct a street railway.

Birmingham.

The Birmingham & Pratt Mines Street Railway Company, capital stock \$100,000, has been incorporated by Jas. A. Van Ioose, H. F. De Bardelaben, A. Marre, Wm. Berncy, Wm. A. Walker, Jr.; Attorney, Wm. A. Walker, Jr. They will construct a street railway.

Mobile.

The City Railroad Company has elected the following officers: A. A. Spiro, president; John Maguire, secretary; Meyer L. Goldsmith, treasurer, and Wm. Frolickstein, superintendent.

**

COLORADO.

Pasadena.

The Pasadena Street Railroad Company has been incorporated, with a capital of \$50,000, composed of 500 shares of \$100 each. The directors are Stephen Townsend, Wm. Thompson, R. Williams, F. M. Ward, J. R. Thomas, P. M. Green, P. G. Wooster. \$21,400 of the capital stock have been subscribed.

**

COLORADO.

Trinidad.

The street railway in this town has been put up at auction.

**

DISTRICT OF COLUMBIA.

Washington.

On the 8th inst., a new schedule went into effect on the Metropolitan road, by which working hours were reduced to 12, without decrease of pay.

**

ILLINOIS.

Belleville.

Work on the new street railway will be commenced shortly. Some of the iron has been delivered.

Chicago.

Articles of incorporation were filed with the Secretary of State, at Springfield, on the 12th inst., by the Palace Street-Car Company, of Chicago; capital stock, \$500,000; to manufacture and operate palace street cars in connection with street railways; incorporators, Benjamin Lindauer, Fordyce H. Waterbury, and Thomas S. Cunningham.

On the 23d inst. the West Division Railway Company entered suit in the Superior court, asking that the city of Chicago and Mayor Harrison, in his capacity of acting commissioner of public works, be restrained from interfering with the company in laying tracks on Polk street, between 5th avenue and Canal street. A temporary injunction was issued.

A suit to test the validity of the Ogden avenue horse-car ordinance has been taken under advisement by the Supreme Court, and a decision is expected about May 10.

The Illinois Central Railroad Company has made arrangements to improve materially its suburban service, and on May 1st, 84 new trains will be added.

Evanson.

The Evanson Street Railway Company, capital stock \$150,000, has been incorporated by Sidney G. Cooke, R. Cheney and C. J. Gilbert, to construct, equip and operate a street railway, by horse or cable power, in the village of Evanson.

**

INDIANA.

Elkhart.

The Elkhart Street Railroad Company, the incorporation of which was reported in our January number, failed to secure a franchise, the exclusive rights for that city having been granted to the Citizens' Street Railroad Company. The latter company is officered as follows: Presi-

dent, F. W. Miller; Vice President, G. C. Johnson; Secretary, E. C. Bickel; Treasurer, A. K. Burns. They will build during the present year about three miles of standard gauge track. The Elkhart Street Railroad Company goes out of existence.

**

IOWA.

Burlington.

The Elevated Cable Railway Co. has been formed to control the rights of the Hale single rail patents. President, J. N. Newton; Vice President, E. S. Edgar; Superintendent, P. Hale; Secretary and Treasurer, James Frame; Attorney, T. Hedge. Boston and Chicago capitalists are said to be considering the system.

**

KENTUCKY.

Bowling Green.

The Park City Railway has been incorporated to build a street railway in Bowling Green.

Louisville.

The bill amending the charter of the Central Passenger Railway Company, and extending it ninety-nine years, passed the Legislature at Frankfort early this month.

Paducah.

The Paducah Street Railway Company is incorporated.

Stanford.

The Stanford Street Railway Company is incorporated.

**

MASSACHUSETTS.

Adams.

The Hoosac Valley Street Railway Company had a recent hearing before the town selectmen. The route proposed extends from the bridge in Adams, near the Plunkett & Wheeler mill, through Commercial street north to the crossing of the Boston and Albany road, then through Park street to a point near Follet's office, and from there through the road past the zylonite works to the north line of the town.

Boston.

The committee on street railways recently gave a hearing on the petition of John E. Enos and others to build an electric elevated railroad from Winthrop Junction through the town of Winthrop to Point Shirley.

The City Elevated Railroad Company proposes to build from Scollay Square to Harvard Square, Cambridge, and other suburban points not more than five miles outside the city line. Permission is sought to build the line on the Moulton system.

The Boston Cable Street Railway Company's route is to be between Boston and Brookline, through Cambridge. The capital is \$500,000, and the length of line about ten miles. Among the directors is Peter Widener, of Philadelphia.

A dispatch dated the 13th inst., states that more than 300 drivers, conductors, and other employes of the Cambridge and Charles River Horse Railroad joined the Somerville Branch of the Knights of Labor that morning, and that they meant to demand \$2 a day for conductors and drivers, and an increase in stablemen's pay.

Holyoke.

At a special meeting of the Holyoke Street Railway Company, it was decided to authorize the directors to make a loan for the purpose of extending and equipping the line along the new route granted by council last December. This extension is to reach Beach street by way of High and Appleton streets, and receives the hearty endorsement of citizens generally.

Lynn.

The Lynn and Nahant Electric Railway Company projects a surface road. A 36-inch gauge railroad is also proposed between these places, and the Lynn and Boston Horse Railroad Company desires to extend its line into Nahant.

Naumkeag.

The Naumkeag Railway is authorized to purchase the Salem Street Railroad.

Springfield.

The Mill River Railway Line will, this spring,

increase its service one-third. Open part of improved pattern will be added, and closed and open cars will make alternate trips.

Worcester.

The Citizens' Street Railway Company, capital stock \$100,000, has been incorporated. The length of the proposed line is about eight miles, with a gauge a foot 3/4 inches. The officers are: Charles B. Pratt, Eli J. Whittemore, Hiram Fobes, Henry S. Pratt, Azariah S. Tripp and Griffith M. Haffards, directors; R. J. Tamm, clerk, and F. N. Brightman, treasurer.

A dispatch dated the 19th inst., states that the directors of the Worcester Street Railroad Company have increased the pay of their conductors from \$1.60 to \$1.80 a day for nine trips and twelve hours' work. The men will also in the future receive twenty cents instead of eighteen cents for extra trips.

The whole of the \$100,000 capital of the Citizens' Street Railway Company has been taken up, and the line will be commenced this spring. The first section will be laid on Pleasant street. Superintendent, F. W. Bridgman, Fall River.

MINNESOTA.

Mankato.

The new street railway is well under way, and the rolling stock and equipment have been ordered.

Minneapolis.

The drivers and stablemen, numbering two hundred, employed by the Minneapolis Street Railway Company, during the early part of the month, seriously contemplated striking for shorter hours. Most of them belong to the Knights of Labor. However, on learning that Superintendent Goodrich had stated that the company was willing to grant any reasonable demands, and that it had under consideration a plan to increase the wages by letting the men work by the hour, and on the withdrawal of opposition to the union, the matter was dropped. Finally, on the 11th inst., the hours were reduced and the wages increased satisfactorily.

Stillwater.

A new street railway has been talked of for some time past in this town.

MISSISSIPPI.

Natchez.

The Natchez Street Railway Company has been incorporated and will build a road.

MISSOURI.

Kansas City.

The City Council has granted cable or electric railway franchises to the following companies: The Kansas City Cable Line Railway, and the Westport Horse Car Line, and to Ex-Governor T. T. Crittenden. The projectors of the new lines have decided to adopt a track slot, which will, it is believed, in a great measure remedy the evils of the rounding edge now used on the existing line.

St. Louis.

Recently the management of the Broadway and Cass Avenue Street Car Lines of this city advanced the wages of their employes to \$2 for twelve hours' work per day. This action has engendered dissatisfaction among the employes of the other lines, and a strike is threatened unless they receive the same concessions.

The prospect is good for the projected elevated electric railroad.

Westport.

The Horse Car Railway Company proposes to change its line to a cable road. The Corrigan Consolidated Company also proposes to adopt the cable system on some of its routes.

NEBRASKA.

Omaha.

Arrangements have been perfected to proceed at once with the Omaha cable railway, a charter for which was obtained over a year ago. Construction work will be begun early next month. Four miles of double track will be built this season and be in operation in November. The

company is composed of well-known Omaha capitalists. It is expected that the four miles will cost a total of \$250,000. The mileage will be increased next year to ten miles, the total cost of which will be about \$600,000.

* *

NEW JERSEY.

Jersey City.

President Thurston, of the Jersey City and Bergen Railroad Company, is arranging a new time schedule and a new wage-rate for the employees of the road. He says: "It is our earnest desire to arrange a time-table whereby a majority of the drivers and conductors will not be on duty more than twelve hours a day, and, in a few instances, thirteen. Of course, the men will have to take their turns at the thirteen-hour days, but they will have longer 'swings' at noon.

The Jersey City and Bergen Railroad Company has recently purchased forty-six fresh Indiana horses, and has ordered seven open cars for the Greenville line. The cars will be delivered in May and will be put on in June for the summer. A number of new close cars are being built for the other lines. The rolling stock of the company is being constantly augmented and improved.

On the 16th inst., a petition from the majority of the drivers and conductors in the employ of the Jersey City and Bergen Point Horse Railroad company, asking that twelve hours be made a day's work, was presented by a committee to Superintendent Sayre. Mr. Sayre said that the request would be complied with so far as possible considering the nature of the service.

Newark.

The employés of the Consolidated roads are said to be very much dissatisfied with the new rules and regulations.

* *

NEW YORK.

Brooklyn.

The Atlantic avenue lines will be extended on Park avenue, from Vanderbilt avenue to Myrtle avenue, and thence up Central avenue. The new track will be two miles in length. The company has the necessary rights under its charter, and has received the permission of Common Councils to do the work.

The Kings County Elevated Railway Company is being investigated. Brooklyn does not wish New York to surpass it in "previousness."

The Calvary Cemetery and Greenpoint Park Company has been re-organized, with Patrick Hayes, president, and Joseph Hudson superintendent and foreman. Five one-horse cars will replace two-horse cars now in use.

The Coney Island and Brooklyn Railroad Company has agreed to increase the pay of its men from \$2 to \$2.25 a day, and to pay thirty-four cents for extra trips on the Smith street line and twenty-two cents for extra trips on the Hamilton avenue line. The men are satisfied with the concessions.

The directors of the new Central Elevated Railway Company have elected Austin Corbin president, E. A. Abbot vice-president, N. H. Frost secretary and treasurer, and William Richardson, Wendell Goodwin and J. Rogers Maxwell, executive committee.

The new Ralph avenue line has been opened. The cars are dark red and are marked "Broadway & Ralph Avenue." They will run regularly from Ralph avenue and Atlantic through Ralph avenue and Broadway to the foot of Broadway.

The conductors and drivers on the Gates Avenue car line of the Brooklyn City Railroad have received notice that the practice of requiring them to wash their cars before starting is discontinued. A gang of men has been engaged to do this work at night. This will give the drivers and conductors half an hour less work.

Mayor Whitney having failed to take action on the recent resolution of the Brooklyn Aldermen requiring all street-car drivers to be licensed after April 1, the measure has become a law.

The fine new depot, car-sheds and stables of the Lutheran Cemetery and Cypress Hills Rail-

road Company, on Palmetto street, took fire on the 27th ult. There were no horses burned, so far as known, but the depot, car-sheds and stables were demolished. There were also forty cars, seven Baldwin motors, and a quantity of harness burned. The company estimates its loss at over \$100,000. It is insured in various companies, but not for the full amount.

Mayor Whitney has appointed a railroad commission to lay out the route of an elevated road along Atlantic avenue. The commission consists of Horatio C. King, William M. Cole, W. L. B. Steers, Charles J. Henry, and William T. Lane.

At a meeting of the Executive Committee of the Myrtle Avenue Elevated Railroad Company, held on the 9th inst., it was decided to begin work on the Myrtle avenue extension just as soon as the weather becomes settled.

The Brooklyn City Railroad has decided to build a hotel somewhat similar to Brighton Beach Hotel, on the shore road at the terminus of the steam railway at Fort Hamilton. The hotel will be six stories high, surmounted by a cupola, and will have a commanding view of the narrows. The rear of the hotel will be near the waters' edge. The building will be completed, if possible, in July, and will contain billiard rooms, ball and reception rooms, and all the concomitants of a first-class resort. The contract for the mason work has been awarded to James Ashfield & Son, and work will be begun on it immediately.

The Brooklyn City Railroad has commenced laying a new track along Flushing avenue, outside the city limits, in Queens County. The road will be completed to Grand street during the summer.

Buffalo.

A local says that the street-car companies expect that the legislature will amend their charters so as to compel them to sell tickets for children under fifteen years of age at the rate of three cents a ride, and to order heating apparatus to be put in and run with each car from November until May of each year.

Hempstead—(Queens Co.)

The Local Highway Commissioners have granted to Chas. A. Cheever a charter to build a new street-railway from the Long Island Railway depot, in Hempstead, to the Ocean in Far Rockaway.

Newburg.

The City Common Council, on the evening of the 19th ult., unanimously passed an ordinance granting a franchise for building a street railway. The line will occupy about four miles of streets, and will be the pioneer street-railway of Newburg.

New York City.

During the past ten years the street railway companies of this city have paid into the municipal treasury for licenses, taxes on tracks and personal property, and for franchises, \$1,445,530, with a debt still claimed of \$795,707.

It is expected that the Assembly will pass a bill which has been reported favorably from the Committee on Railroads, permitting "the purchase of at least five tickets at the elevated railway stations at five cents per ticket, at all times and for use at all times."

On the 17th inst., Senator Traphagen introduced a bill reducing to three cents the fare for every passenger on any street railway car that may use the tracks of the Broadway Surface Railway Company. The bill affects the present cars of the Broadway Surface Railway that travel from one end of the line to the other, the cars of the Seventh Avenue Company, of the Bleeker Street Railway and of the Christopher Street and Tenth Street Railway. If cars of these railways run over the tracks of the Broadway road their conductors are not to charge passengers over three cents, whether on Broadway or off it.

A bill introduced into the Assembly by Mr. Shea, on the 8th inst., provides that before any corporation, organized for the purpose of constructing and operating surface or underground railroads in any of the cities of the State, shall

proceed to take up streets or pavements, they shall, after gaining the consent of the local authorities, file in the county clerk's office the consent of two-thirds of the owners of the real estate fronting on the street, and also file with the clerk of common council and with the State engineer, statements in duplicate, showing the names and residences of stockholders, the amount of stock held or paid for by such stockholders, the names and residences of contractors, and the sums agreed to be paid persons owning property fronting on the street.

An attempt is being made to pass a bill through the Assembly repealing the law of 1855, which prohibits the laying of tracks in Fifth ave. It is said that the petition has the signatures of 250 property owners on the avenue. The New York Cable Co. is thought to be backing the scheme, and to intend making the proposed line a cable road.

The suit of the New England Iron Company against the Manhattan Railway Company, in which \$6,000,000 were claimed for breach of contract, was settled for \$250,000 by a compromise.

The Manhattan Elevated Railroad proposes building a branch from Grand Street ferry to connect with the Second avenue line. On the west side a branch will be built from the Battery along West street, passing all the ferries and connecting with the Sixth and Ninth avenue lines at some point above Canal street. An extension is also to be made to supply the district north of the Harlem river.

The Manhattan Railway Company will issue in April, probably, \$1,000,000 debenture bonds for the payment of new equipment and new construction and arrears of taxes. The company has recently bought one hundred new cars and fifty new engines, of which about one-half have been delivered. The bonds will be taken, it is said, by officers and friends of the company who have made the advances for these obligations.

A bitter attack is being made upon the charter of the Broadway road.

A bill was presented in the Assembly, on the 19th, making the Brooklyn Bridge free for pedestrians and for carts and horses.

A bill is under discussion in the committee of the whole in the State Legislature, modifying the General Railway Act of 1875.

The Cable Railway Company asked for the franchises of seventy miles of street, which the aldermen granted. The mayor vetoed the resolution on the ground that the percentage of the net proceeds offered was not sufficient. It was thought that the resolution would be passed over the mayor's veto, whereupon injunctions were obtained to prevent such action. Meanwhile arguments are being heard for and against making the injunction permanent, and in Albany against the Cantor bill, the text of which we give in another place.

The President of the Southern Boulevard Railroad Company has asked the permission of the Park Board to lay tracks for a railroad on the Boulevard, from its junction with Third avenue to the old Boston road.

The Citizens' Railroad Company proposes to lay tracks from West Fourth street and South Fifth avenue to and along Mercer, to Howard, Hester, Baxter, Chatham, Roosevelt, Madison, Rose, Frankfort, William, South William, Broad, Water, Nassau, Duane, Park and several other streets.

At the March meeting of the Bridge Trustees the Executive Committee reported in favor of the purchase of one new switching locomotive and eight new cars, and this was ordered. It was also decided to purchase a lot of ground, 40 x 24 feet, in Stewart's alley, Brooklyn.

The directors of the Sixth Avenue Railway Company have been re-elected, as follows: Samuel Thorne, F. P. Olcott, Frank Curtiss, A. R. Van Nest, Henry Demorest, William Bryce, Wm. Y. Mortimer, Albert W. Green, Theo. E. Macy, Abijah Curtiss, Chas. G. Langdon, Henry S. Moore and John Watsch.

The mayor has vetoed the resolution of the board giving the Madison Avenue and Eighty-

sixth Street Railroad Company permission to operate a railroad upon the transverse road through Central Park. He deems the road desirable, but thinks the franchise should be sold at public auction.

The council has adopted a resolution calling upon the corporation counsel for an opinion in regard to the right of the board to order the sale at auction of all railroad franchises at the disposal of the city.

A bill compelling the New York street railroad companies to employ conductors on "bolthead" cars, has reached a third reading in the assembly.

Rockaway.

The Rockaway Village Railroad Company was incorporated on the 8th inst. The proposed line begins at the intersection of Catherine street and Mott avenue, running thence southerly along Catherine street to Clark avenue, along Clark avenue to the Turnpike, and to the high water line on Rockaway Beach or inlet. Also from Clark avenue and Catherine street southerly along the latter street to Lockwood avenue, to Turnpike road, the length of the road being one mile. The capital is \$25,000, divided into \$100 shares. The directors are Charles A. Cheever, John D. Cheever, David L. Haight, Joseph S. Auerbach, C. Fred. Richards, New York; William A. Wynn, Far Rockaway, and Christopher Cunningham, of Brooklyn. The thirteen subscribers to the capital stock take one share each, and include besides the directors, Andrew McTighe, of Far Rockaway, and Robert J. Montgomery, Brooklyn.

Seneca Falls.

The Seneca Falls and Waterloo Railway Company has purchased for \$10,000 fifty acres of the "Wayne Farm," on Cayuga Lake, including a popular picnic ground known as "Wayne's Grove." A commodious summer hotel will be erected on the property, and the street railway line will be extended to this point as soon as the weather permits.

Articles of incorporation have been filed with the Secretary of State for "The Seneca Falls, Restvale and Cayuga Lake Street Railroad Company." The route proposed is from the corner of Bridge and Bayard streets to Restvale cemetery; thence south on Stephenson street to the bounds of the village; then east through Wayne's lane to the lake's termination at Wayne's woods, the entire distance being three miles. The work of construction will be begun as early as possible. The officers of the company are: President, De Witt C. Hancock; Vice President, David Cushman; Secretary and Treasurer, Peter Trautman; Directors, D. C. Hancock, Col. S. B. Johnson, Nelson Duntz, Weed Barnum, William B. Rupert, Peter Trautman, J. Marshall Guion. The capital stock of the company is \$30,000, ten per cent of which has been paid in. The eastern terminus of the new road is at one of the most popular pleasure resorts in this section of the State, which has been thronged annually with visitors, despite the inconvenience of access.

Schenectady.

A new five mile street railway is projected. Capital, \$50,000.

Troy.

On the 9th inst., 300 conductors and drivers struck, by order of the Knights of Labor, which organization they had joined about three weeks before. The demand was for a reduction of hours without reduction of wages, and a better schedule of wages for "trippers." For some hours no cars ran on the lines between Troy, Lansingburgh, Cohoes and Waterford. The demands were acceded to, and the hours reduced from 17 to 12 at the same pay.

The Troy and Lansingburgh Street Railroad Company is having constructed at the Pullman Car Works a dining-car to be used exclusively by the conductors and drivers in its employ. The car will be switched upon a side track and be used by the employes of the road between the hours of 11:30 and 1:30 each day for eating their meals in.

OHIO.

Cincinnati.

The Consolidated Street Railway Company will probably resist the order of the Board of Public Works requiring it to complete route 18 to Cumminsville, on the ground that the pike has not been improved.

In another column we give full particulars of the recent misunderstanding between the street railway companies and their employes. No further trouble is feared, as the matter was arbitrated to mutual satisfaction. The threatened strike involved over 1,000 men.

Cleveland.

A special says: The question of shorter hours of labor on street railroads has been agitated in this city for some weeks, and a bill is now pending in the Council to limit the time to twelve hours. To-day (9th inst.) the directors of the Brooklyn Street Railroad, one of the largest in the city, voluntarily reduced the hours of labor of its employes to twelve a day for all hands. This makes the actual working time eleven and a half hours. The wages of drivers are also advanced to \$1.75 a day—the same as paid conductors.

At a meeting of the stockholders of the St. Clair Street Railway Company, March 2d, Mr. A. G. Hathaway was elected secretary, vice Mr. S. Robinson, resigned.

At the annual stockholders' meeting of the Woodlawn Avenue and West Side Street Railway Co., the following officers were re-elected: M. A. Hanna, president; C. F. Emy, vice-president; J. B. Hanna, secretary, and George G. Mulhin, general superintendent. All the directors being also re-elected.

Columbus.

A special dated March 18th reports that the employes of the Consolidated Street Railway, to the number three hundred, went on a strike for an advance in wages this morning, and the cars on none of the lines were operated during the day. The men were orderly, and, although several attempts were made to run out cars, they succeeded, without creating much excitement, in forcing them to run in again. During the day negotiations for a compromise were in progress, but the differences were so great that it looks as if they would be unable to arrive at any conclusion. The feeling is very bitter, though there is a studious effort on all sides to prevent any demonstration which might result in a riot.

Dayton.

The drivers on the Third street car line struck on the 20th inst. for \$1.75 for twelve hours. The Knights of Labor propose to boycott the road in case other men are employed in the place of the strikers. When the company learned that the strike was on, they ran their cars into the shed as they came in, discharging each driver, and when all were in, locked up the car sheds and stables. The drivers have been receiving \$10 per week, working an average of fifteen hours per day, seven days in the week, and laying off every eleventh day, for which they were paid. The strikers ask \$1.75 per day of twelve hours.

Toledo.

The Consolidated Street Railroad Company has announced that it will advance the wages of the employes and raise the hours of work. The men heretofore worked sixteen hours. This action is entirely voluntary on the part of the company.

PENNSYLVANIA.

Philadelphia.

The southern portion of the new depot and stables of the Union Line, on the square bounded by Huntingdon street and Lehigh avenue and Hancock and Mutter streets, is under roof, and of the northern portion the walls are just going up.

There has been an uneasy feeling among the Philadelphia street railway employes, which might at any time have broken out in open revolt. The Car Drivers and Conductors' Association has been formed and is now recognized as Assembly 1994, Knights of Labor. The Peoples' Line, seeing the current of events, made a

diplomatic move on the 6th inst., by reducing the hours of labor of its employes to twelve and making a uniform pay rate of \$1.75 per day. Heretofore conductors have received \$2 per day, but have been unable, except in rare instances, to make full time. Drivers have had \$1.75. Under the new schedule full time is made, and the employes seem well satisfied with the improvement. The plan will probably be generally adopted, otherwise the men will be likely to demand twelve hours and \$2 per day. It is said that the change adds to the wages expenses of the Peoples' Company about \$10,000 per year.

The State Supreme Court has decided that passenger railway companies in Philadelphia must keep in repair the streets over which their cars run.

A fire in one of the Peoples' Company's three stables, at Eighth and Dauphin streets, on the 8th inst., caused a loss of \$5,000 on the buildings and the hay and straw stored there. Three hundred and seventy-eight horses in all were in the stables at the time, but they were all safely removed.

Pittsburgh.

The street railway employes, to the number of about 1,500, have joined the Knights of Labor, and are threatening a strike because of the discharge of a number of drivers and conductors on Citizens' Railway. The men also demand a reduction of time to 12 hours per day at the present rate of wages—conductors, \$2; drivers, \$1.75 per day.

The Transverse Passenger Railway Company will make considerable extensions and changes in its routes early in the season.

York.

A new street railway is under construction in this town, and will probably be completed during the season.

RHODE ISLAND.

Providence.

On the 10th inst. the drivers of the Union Street Railroad met and decided to demand an increase of pay from the rate heretofore paid (\$2.25 per day) to that received by conductors (\$2.50). They work only eleven hours per day. A majority are said to have favored striking if the demands were not acceded to.

TENNESSEE.

Knoxville.

The Citizens' Street Railway Company has been organized by E. C. Jones and others to build a new street railway.

TEXAS.

Austin.

A company is being organized by D. M. Wilson and other citizens for the purpose of building a street railway.

Street railway matters are a little strained. An ordinance for a new line contained such severe restrictions that the parties refused it, and it was repealed. Later on a more favorable ordinance was passed with an amendment striking out from the route all streets occupied by the existing company, and this ordinance was withdrawn. Another company is laying tracks on several streets. T rails are used.

WISCONSIN.

Appleton.

The Appleton Electric Street Railroad Company, capital stock \$35,000, has been incorporated by J. E. Harriman, G. W. Gerry, R. M. Lunt, T. W. Orbison, James Roffard and N. B. Clark, who intend constructing and operating a street railway here.

Milwaukee.

Chas. F. Freeman, J. A. Becker, E. R. Paine, Henry Herman and John Durbin have incorporated the Peoples' City Railway Company, to build a street railway from end to end of the city, north and south, and from the Chicago & Northwestern Railway depot, on the lake, to the Chicago, Milwaukee & St. Paul station, on the west

side, and thence out Clybourn street to the city limits. The capital stock is \$100,000; shares \$100 each.

A meeting of the directors of the Milwaukee City Railway Company was held on the 21st inst. to discuss the action of the car drivers in organizing an assembly of the Knights of Labor. The company had offered the men an increase in wages of \$1 a week providing they would not join any labor organization. As the men had seen fit to ignore the offer it was withdrawn. The matter will now be suffered to rest until the return of President McGeoch, who is in California, and is expected to return about the 1st of April.

Oshkosh.

Following is the correct list of officers, etc., of the Oshkosh Street Railway Company, incorrectly given in all published lists: Length, 4 miles; 24 horses. Officers, president, Leander Choate; vice-president, F. Zentner; secretary and treasurer, Jesse Hull; superintendent, L. Thompson.

Racine.

The new street railway is prospering under the management of the younger Mr. Hemenway.

FOREIGN ITEMS.

ARGENTINE REPUBLIC.—A dispatch from the city of Concepcion, *via* Galveston, says that a street railway is about to be constructed in that city.

THE MEXICAN STREET CAR.—Joaquin Miller has in the Chicago *Times* an interesting letter from the City of Mexico, from which we clip a few paragraphs about the street cars:

"The street cars from the Grand plaza of Mexico City pass over the spurs of 'Chapultepec,' below the battle ground of 'Molino del Rey,' across the battle ground of 'Churubusco,' and on in a direct line to 'St. Angel.' This latter place was Gen. Scott's headquarters for a time, and is on the foot-hills and about a dozen miles from Mexico."

"Let us go by Mexican street car to St. Angel, if you please. And let us take the second-class car. This is the best for several reasons. In the first place it is safest from disease and vermin. For the first-class car is cushioned, while the second class is hard wood and washed white every day. And then it only costs a 'bit,' while the first-class car costs a quarter. We do not want to take the third class, because that carries freight, as a rule, and you have to stand up. Nor do we care to take the fourth class if we can help it. For the fourth class car is a black car, and carries only the dead. Yet they all go at the same time and in a solid line, every hour, starting from the Grand plaza before the palace, where all the street cars in Mexico City start from."

"You may ask, if you like, why they all start at the same time and travel in solid line. You will be politely told that it is done to protect the street cars from brigands. And, maybe, the little American lady traveler will gasp and find her smelling bottle; and, most certainly, the special correspondent gentleman will whip out his notebook, write it down, and believe the nonsense to the letter."

"The secret of it all is 'tips.' The street car driver and conductor and collector of fares—it takes three men to run one car—only receive \$1 a day—a Mexican dollar equals 75 cents—and so they have to be pretty sharp to live. One of their rescuers for revenue is to tell startling things to travelers, frighten them a little if they can, and so secure a 'tip' out of them in return for information of this sort along the historic routes. But the truth is there is as little danger of brigands or anybody else in going from the Mexican palace to St. Angel as there is in going from the Battery to Harlem, New York."

"The driver, with a big brass horn, blows a long blast in the hall, the other drivers followed, and we clamber in as the ten packed, crowded cars trundle on down the paved and brilliantly-colored street."

BLACKPOOL.—The electric tramway on the promenade in Blackpool, England, the mechan-

ism of which was illustrated in our February number, is now in full working order, and cars driven by electricity run daily. A statement of the cost of laying the lines by the corporation has been issued. The line is two miles 1,000 yards in length, and the actual sum expended was \$55,000. The cost of laying the central channel for the electric apparatus was borne by the company which works the line.

TORONTO.—A strong effort is being made to have cars run on Sunday, but as public sentiment is decidedly opposed to it, failure is predicted for this effort; particularly as previous attempts have failed for the same reason, and public opinion has not changed.

THE TORONTO LOCKOUT.—Toronto, Canada, has not escaped the striking fever that has been sweeping over most of the larger American cities during the past few weeks, and during the 10th, 11th and 12th instants the Street Railway Company had serious difficulties with its employes, which, on the 12th, became very nearly a riot. The history of the affair is briefly this: About six months ago three members of a union were discharged by the company, and the remaining employes signed an agreement not to join or be long to any union. The men did not keep this pledge, but on the 9th held an all-night meeting at which 132 paid their fees, and organized a union, which applied for admission into the body of the Knights of Labor. The company being fully informed of these events, on the morning of the 10th, the superintendent erased from the service board every name, which was equivalent to a general discharge of the employes. He then began rehiring such as were known to be non-union men for the early trips, but most of these left their cars on returning to the sheds. A driver who was drumming up recruits for the union was then arrested, but was released on personal bail. Up to noon a few cars continued to run on the Quebec and Yonge streets lines. At 2:30 the mob commenced to blockade the streets by driving drays on the tracks, derailing cars, and cutting loose the teams. The police attempted to force a car through, but were frustrated. About the same time an effort was made to run a car down West Market street hill into the bay, but it ran into a snow-bank. No more cars ran that day. The men held an enthusiastic meeting in the late afternoon, at which large threats were made.

The Hon. Frank Smith, president, in an interview gave the company's side of the question and ultimatum, as follows:

"The company has seen trouble and hardships brought on the men themselves, in other places, on account of strikes and trades unions, and has resolved that it should have no union men in its employ."

"We say to a man, 'If you want to keep away from unions you can work for us, but if you will not consent to do this you are at liberty to go.' We make this stipulation because we know that otherwise the Knights of Labor would conduct the street cars."

"Every man who comes to us for employment has an agreement-paper to this effect put before him, and if he will not sign it we do not employ him. As nearly as I can recollect it the agreement reads something like this:

"I hereby agree that I will not join any union or belong to any union while in the service of the Toronto Street Railway Company."

"If any man after thus binding himself, breaks the agreement he is dismissed. Notwithstanding the agreement which all of the men in our employ have signed, they form themselves into a branch of the Knights of Labor."

An attempt was made to induce the street-car men in North Toronto to strike, but they refused.

On the morning of the 11th, one trip was made with difficulty by a Queen street car. The mob prevented the passage of all the other cars, and handled a driver severely, and even the police failed to take the cars through.

On the 12th inst. the trouble became serious. According to instructions of the president of the company, the running of cars was left in the hands of the city commissioners. Late on that morning a car manned with a force of police left the stables and started over the Front street route. Before the car had proceeded many

blocks, the street was blockaded by coal carts, express wagons, etc. The police were powerless, and the attempt to run the car through was abandoned. The car was then turned toward the stables, when the mob wrecked it. The driver and conductor were seized by the rioters and severely beaten. A squad of mounted police charged on the mob, using their clubs freely. Several of the police were struck by stones and injured, while one was knocked off his horse, but not seriously hurt. Two arrests were made, and in spite of efforts made to rescue them, the prisoners were taken to the station. The horses of the car were taken back to the stables, and preparations were made to run another car on the King and Yonge street route. The police were re-inforced, and strong detachments were along the route. The mob repeatedly charged and attempted to disable this car, but the police were determined and succeeded in getting the car through. The batons were again used with good effect, and the ringleaders were arrested. Later a few cars were running in both Queen and Yonge street routes, each car being manned by half a dozen policemen. Owing to a renewal of obstructive tactics, all the street cars were withdrawn between 3 and 4 o'clock in the afternoon. About 2:30 o'clock the police had hot work in clearing Yonge street of the crowds congregated there. They charged the crowd repeatedly, using their clubs effectively. The crowd retaliated by throwing bricks, sticks and stones. The police succeeded, after a half-hour's hard work, in dispersing the mob, who, however congregated around the street-car stables. The police again appeared, and, after a severe struggle, dispersed the crowd. Then there was comparative quiet. Mayor Howland issued a proclamation, calling upon law-abiding citizens to preserve the peace and not to congregate on the streets. Meantime the mayor and aldermen had met informally, and, after discussing the situation, deputations were appointed to wait upon the president of the horse-car company and the strikers. As a result of these conferences, partaking of the nature of an arbitration, on the 13th the men returned to work under the same conditions that existed prior to the lock-out.

As usual, the disaffected employes disavow all responsibility for, or participation in, the riotous proceedings.

L. L.

NOTES AND ITEMS.

NEW ROAD.—The Citizens Street Railroad Co., of Elkhart, Ind., being, as reported elsewhere, about to build a three miles standard gauge road, solicits correspondence on the subject.

STREET CAR BRAKE.—The Mallinckrodt Street Car Brake Co. has been organized at Denver, Colo., with a capital stock of \$150,000. John Mallinckrodt, Emil Brunner and Josephine Mallinckrodt are the incorporators.

TROY CABLE MOTOR.—Articles of incorporation have been filed with the Secretary of State by the Troy Cable Motor and Construction Co., of Troy, N. Y. The object of the company is to supply steam for motive power to propel railroad cars by the method invented by A. H. Lighthall, and to furnish power for manufacturing purposes. The capital stock is \$250,000, divided into 5,000 shares of \$50 each. The incorporators are Gilbert Robinson, Jr., D. Peck, Chas. Angus, A. H. Lighthall and Samuel Foster.

H. H. LITTELL, of Louisville, Ky., recently shipped consignments of his scrapers to Lincoln, Neb., Beaver Falls, Pa., Little Rock, Ark., and Decatur, Ill. Some of these were second or third orders received from the same parties.

HATHAWAY SAND BOXES.—The Metropolitan Company, Boston, has ordered the Hathaway patent sand boxes for its cars. The inventor was an employe of the New Bedford Street Railway Company.

SECOND-HAND CARS WANTED.—Street railway companies having second-hand cars to dispose of can place us under obligations by sending us descriptions and prices. We have inquiries for some such cars, and may be able to place the owners in communication with buyers.

PUGH & RUSSELL, New York, announce that they have fitted up an apartment in connection with their new offices in the "Stewart" Building, Broadway, Reade and Chambers streets, for the exclusive use and convenience of Street Railway Officers and Representatives when visiting New York. Mail will be received and cared for, all standard newspapers and railroad journals will be found on file. Telephone and Messenger service have been provided, and any information desired will be furnished and procured.

AUTOMATIC CAR BOX CO.—The Automatic Car Box Company, capital stock \$2,000,000, has been incorporated in New York City by Russell Brewer, Leos L. Culver, Benjamin B. Kirkland, and P. A. V. Van Doren. Object: Manufacture of automatic car boxes, etc., and the sale of the same.

LOUISVILLE.—Louisville has over 131 miles of single track, more, it is claimed, than any other city in the world of double the population.

LICENSES FOR STREET CARS.—Mr. Farwell has before the New York State legislature a bill which provides that street cars running in any city or village of the State, shall pay a license fee of \$25.

COST OF HEATING CARS.—A local authority says: An estimate of the cost of heating with stoves on the Brooklyn City Railroad is, per horse car, 12 cents and 5 mills per day of 13½ hours. This estimate is based on the cost of heating 90 cars, each having one stove, with coal costing \$4.40 at the dock. But to this there ought to be added loss by reduction of carrying capacity, which on these cars is at certain hours of the day taxed to its fullest extent. If it be assumed that four passengers per day more would be carried by putting a seat in the place of the stove (a low estimate), and using heaters which do not reduce the carrying capacity, 20 cents so lost must be added to the cost as above estimated, making the total cost amount to 32½ cents per car.

FARE BOX AND LANTERN.—A combined fare box and lantern has been patented by Mr. Henry D. Clark, of Rochester, N. Y. This invention covers a novel construction, by the use of which a passenger can drop the fare into the fare box where it is visible to the passenger and conductor before it has been discharged into the money box, that both can be witnesses of its correctness.

CANDEK JOURNAL BEARING CO.—A company of this name with a capital stock of \$1,000,000 has been incorporated in New York City by Hugh R. Garder, Wm. P. Shinn and Charles E. Candee, to manufacture wheels, axles and bearings for street cars or cable roads, etc.

U. S. SCORIA CO.—The United States Scoria Company, capital stock \$150,000, has been incorporated in New York City by Franklin H. Kalbfleisch, Albert M. Kalbfleisch and Wm. H. Kimball. Object: Manufacturing paving blocks and products from furnace slag.

WANTED: POSITION.

By a practical Street Railroad man of 10 years experience in the management of employes and office details. Also several years experience in handling money and tickets. Strictly temperate and can furnish best of references from past and present Street Railroad Officers and others. AGE, 43. Address:

S. LAMBERT,
177 Bank St., CINCINNATI, OHIO.

CHAS. H. MITCHELL,

Attorney and Counsellor at Law.

Practices in all the Courts. RAILWAY LITIGATION A SPECIALTY. Special attention to Patent Cases and Collections. Prompt attention to Correspondence outside the city. Refers by permission to the ENGINEER'S COMPANY, Walden, Monroe & Co., and others.

79 Dearborn Street,
CHICAGO. - ILLINOIS.

EATON & PRINCE,

MANUFACTURERS OF

ELEVATORS

—FOR—

Passengers AND Freight;

ALSO,

SPECIAL ELEVATORS

For STREET CAR BARNs.

74 & 76 Michigan St., CHICAGO.

THIS SPACE WILL BE OCCUPIED BY AN ILLUSTRATED ADVERTISEMENT

OF

J. G. BRILL & SONS, PHILADELPHIA, PA.,

MANUFACTURERS OF

STREET RAILROAD CARS AND TRAMWAY CARS OF EVERY DESCRIPTION.

A. WHITNEY & SONS, **CAR WHEEL WORKS** ESTABLISHED, 1847. PHILADELPHIA, PA.

Street Railway Wheels, Axles and Boxes.

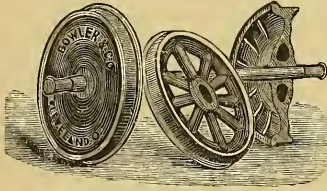

Car Wheels
OF ALL KINDS
FITTED TO AXLES.
Street Railroad Turnouts,
Transfer and Turntables,
Barn Drain Troughs and Fur-
niture.
BOWLER & CO.,
14 Winter St., Cleveland, O.

C. A. PALTZER & CO.,
LUMBER
2598 Archer Avenue, CHICAGO.
Ash, Oak and other Hardwoods suitable for Car and Track Work.
WRITE FOR ESTIMATES.

O. W. MEYSENBERG & CO.,

WESTERN AGENTS
Johnson Steel Street Rail Co.
JOHNSON STEEL GIRDER RAIL
AND STEEL ROLLED CURVES,
Switches and Frogs, also Metallic Ties,
185 Dearborn Street, Adams Express Bldg., CHICAGO.
ST. LOUIS, 204 North 3d Street, Gay Building.

Josephine D. Smith,
350 and 352 PEARL ST., NEW YORK,

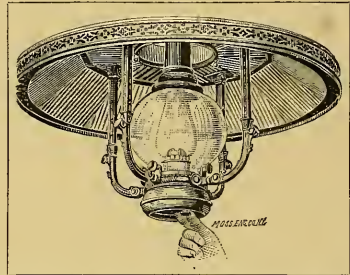

Tin and Brass Box Lamps,
CANNIES, BURNERS, ETC.

METAL CAR TRIMMINGS REFINISHED.
BRASS FINISHING.

Manufacturer of Railroad Car Lamps and Reflectors.

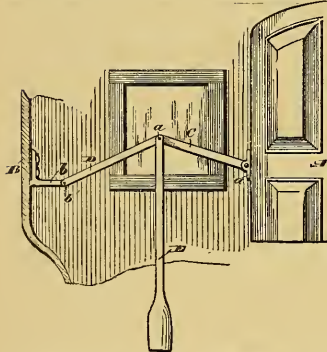

Door closed, fastener in position, weight suspended from the toggle joint, holding it closed.

THE HAYCOX PATENT DOOR FASTENER.

ADOPTED BY
East Cleveland Railway Co., Woodward Avenue and W. Side Railway, St. Clair Street Railway,
Broadway and Newburg Railway, and many others.
PATENTED MAY 5, 1885.

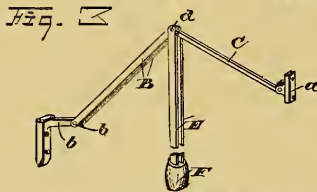

Fastener detached, made of malleable iron, weight about 5 pounds.



Door open. Fastener thrown back.

For further particulars, prices, circulars etc., address
HAYCOX DOOR FASTENER CO., W. E. HAYCOX, Manager,
1158 EUCLID AVENUE, CLEVELAND, OHIO.

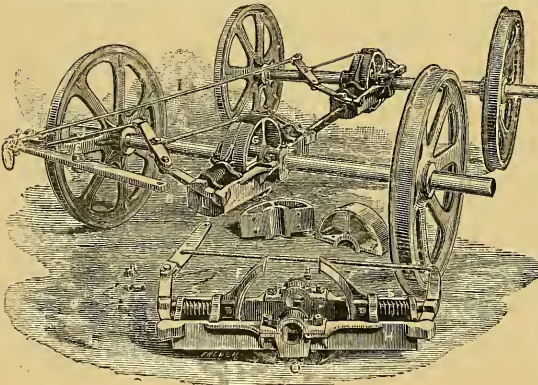

The Roff-Emery Brake!

SAVES WEAR ON WHEELS.
Uninfluenced by Sleet and Snow. Quiet and Efficient.
FIVE YEARS' SUCCESSFUL USE.

Used by—Pittsburgh and Birmingham Street Railway,
Pittsburgh, Oakland and E. Liberty Railway,
Citizens' Pittsburg Railway, Pittsburgh,
Superior Street Railway, Cleveland,
West Side and Woodland Ave., Cleveland,
Toledo Consolidated Street Railway.

FRANK E. ROFF, - TOLEDO, O.

The Street Railway Gazette.

VOL. I.

CHICAGO

APRIL, 1886.

NEW YORK

No. 4.

DE WITT C. CREGIER.

SUPERINTENDENT CHICAGO WEST DIVISION RAILWAY.

After nearly thirty-three years of active connection with the public of the city of Chicago, on March 1st, 1886, Mr. Cregier was appointed Superintendent of the West Division Company's lines, succeeding Mr. James K. Lake, as before announced in these columns. For a period of twenty-five years he filled the position of Chief Designing Engineer of the Chicago Water Works; for three years he was City Engineer, and had filled the position of Commissioner of Public Works five years previous to the acceptance of his present connection.

He was born in New York City, on June 1st, 1829; his parents being John L. Cregier and Ann E. (LeFort) Cregier, the latter a daughter of a well known French shipmaster, who was, for many years, prominently identified with the merchant marine of New York. She was also a cousin of Henry Inman, the famous portrait painter, and related by marriage to Daniel D. Tompkins, at one time Vice-President of the United States.

When the subject of this sketch reached his fourth year, the father died, leaving him to the care of the mother, who survived her husband but a few years, so that after his thirteenth year DeWitt lived with relatives, and attended the common schools of his native city until, on reaching the age of sixteen, he became a clerk in a store.

It took him but a short time to discover that this position was not suited to his tastes, and he soon secured a position in the engineer department of the steamer *Oregon*, owned by Geo. Law, Esq., and running on Long Island Sound, where he remained until 1847. He then entered the machinery department of what was then known as the F. F. Secore Iron Works, of New York, one of the largest establishments of the kind in the country, where he remained until he had mastered the profession of mechanical engineering, in which department he has been so eminently successful.

In 1851 he was connected with the engineer corps of the U. S. Mail Steamers, plying between New York, Havana and New Orleans.

During the summer of 1853, Mr. Cregier came to Chicago to superintend the erection of the first pumping

machinery for the Water Works, and remained in charge of the Water Works continuously—including his service as City Engineer and Commissioner of Public Works—for thirty-three years, during which period he designed and superintended the construction and erection of all the machinery now in use at the North Side Works, including the fine double pumping engine—the largest in the world.

As a Mason, Mr. Cregier stands pre-eminent, not only among the fraternity in the northwest, but elsewhere, for his clear and lucid knowledge of Masonic matters, as well

as for his indefatigable labors in the interests of the brotherhood. He was first inducted into the fellowship of Masonry in 1860, by Blaney Lodge, Chicago, and was shortly afterwards elected Senior Warden, which office he held one year, when he was chosen to preside over that body; which he continued to do, at various periods, for ten years. He was elected to the office of Senior Warden of the Grand Lodge of Illinois, and after holding the office for one term, he was elected Deputy Grand Master for two consecutive years. In 1870, the fraternity conferred upon him the highest honors in their power to bestow, by electing him Grand Master of the Grand Lodge, and at the following annual Communication, held in Chicago, in 1871, further evinced their confidence and appreciation by unanimously re-electing him. He is at present a life member and Master of Blaney Lodge, and an honorary member of twelve other lodges; a member of Lafayette Chapter, No. 2, R. A. M.; a member of Siloam Council, No. 53, R. & S. M.; of Apollo Commandery, No. 1, K. T.; a life member of Oriental Consistory, S. P. R. S.;

member of St. John's Conclave, K. R. & C., all of Chicago, in several of which bodies he has held prominent official positions. He is also a member of Supreme Council, 33rd, A. A. Rite, in the N. W. J. of U. S., and of the Royal Order of Scotland. In addition, he is representative of the Grand Lodge of the District of Columbia, Michigan, Mississippi, Connecticut and Indiana, also of Quebec, Canada, near the Grand Lodge of Illinois; and of the Grand Chapter of the State of New York, near the Grand Chapter of Illinois. He is also President of the Illinois Mason's Benevolent Society; ex-President of the Western Society of Engineers; an honorary member of the Illinois State Association of Architects;



DeWitt C. Cregier

and a member of the American Society for the Encouragement of Arts, Manufactures and Commerce.

Like most thoroughly practical and theoretical mechanical engineers, Mr. Cregier has a mind stored with ingenious resources, and seldom meets a mechanical emergency without finding himself prepared for it. He is the inventor and patentee of a large number of well known machines and appliances used in connection with water supply systems and other public works.

On the 2d of August, 1853, Mr. Cregier was married to Miss Mary S. Foggin, of New York City. The couple have six sons and one daughter—all born in Chicago—living.

As we have before related in these columns, at the last annual stockholders' meeting and election of the Chicago West Division Railway Company, Mr. Cregier was elected Superintendent. It is seldom that a municipal department bids farewell to its chief with reluctance so sincere as that which expressed itself on Mr. Cregier's retirement from the Commissionership. And not only did his own immediate department express itself on this occasion, but every officer and employé of the city, from the Mayor to the firemen in the water-works, testified his regret at the severance of long-tested friendship and business intercourse. Testimonial after testimonial was given him, and they were doubtless sincere, and were certainly deserved, for amid all the corruption existing in Chicago politics, D. C. Cregier has never given cause for a breath of suspicion, but his administration has been straightforward, manly and honest.

In assuming his new position, Mr. Cregier quietly set to work to study the details of the road and its workings, and, having mastered them, started vigorously to rectify what he considered wrong and to give his official sanction to the existing rules which he approved. He proved the conservatism and clearheadedness with which he is credited, by avoiding all show of sweeping changes or reforms.

Personally, Mr. Cregier is a very agreeable man to meet, is uniformly affable and courteous, but business-like and direct in his language. He has the rare faculty of being a good listener, and the still rarer one of digesting what he hears even while hearing it, and being ready when the speaker has finished, to return a concise, well-fortified reply. He is cultured, keen-witted, and of remarkably industrious habits, and holds his own with ease in social, scientific and business circles.

REMOVABLE HORSE SHOE.

The accompanying engravings illustrate in detail, a recently invented horse-shoe, of the composite type.

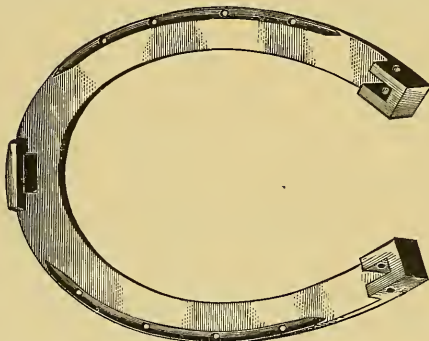

FIG. 1.

Figure 1 shows the permanent section, which is nailed to the hoof, and is removed only as occasion may demand readjustment of the shoe or dressing of the hoof. It has on its under surface (the side shown in the cut) a slot at the toe, in which a tongue of the calk-holding section engages, and two mortises, one on each heel-piece, for the reception of tenons of the other section.

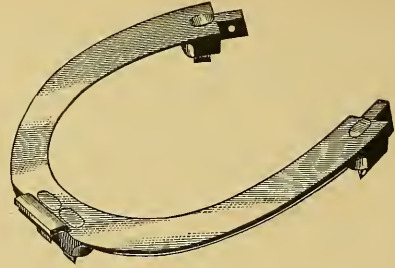

FIG. 2.

Figure 2 represents the detachable section, holding the calks. In the engraving the calks are directed downward in the position they assume when in use. The tongue at the toe, which engages under the shoulder of the toe-slot in the permanent section, as already mentioned, as well as the tenons on the heels, are shown. The manner of insertion of the calks can also be seen.

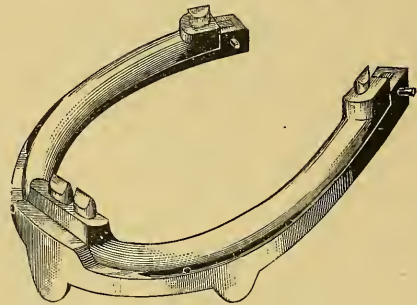

FIG. 3.

Figure 3 shows the complete shoe, calks upward. The pins (or cotters) which, passing through corresponding holes in the heels of the two sections, hold them securely together, as well as the "clips" with which the permanent section is furnished, are shown.

The claims made are, quickness of shoeing, as the removable section can be taken off, the worn calks knocked out, new ones substituted, and the shoe replaced in a very short time; ease of changing from "smooth" to "sharp" shoeing, etc.

The shoe is made of cast steel and the calks of tool steel. No screws are used in any part of it. It is said to be inexpensive. In use on the Buffalo street railroad.

STANDARD STREET RAILWAY LOCOMOTIVE.

The detailed illustration accompanying shows the arrangement of machinery on a street locomotive in use at various points. It is used by the New Orleans City Railroad; the College Hill Railroad, Cincinnati, Ohio; Home Avenue Railroad, Dayton, Ohio, etc.

They are made of various cylinder dimensions, etc., the principal sizes being as follows:

| | | | | | |
|---|--------------|--------------|--------------|--------------|--------------|
| Cylinders { diameter | 5 inches | 6 inches | 7 inches | 8 inches | 9 inches |
| stroke ... | 10 inches. | 10 inches. | 12 inches. | 12 inches. | 14 inches. |
| Diameter of driving wheels | 26 inches. | 26 inches. | 28 inches. | 28 inches. | 30 inches. |
| Wheel-base | 4 ft. 0 in. | 4 ft. 0 in. | 4 ft. 8 in. | 4 ft. 8 in. | 5 ft. 3 in. |
| Length over all | 11 ft. 0 in. | 12 ft. 0 in. | 13 ft. 0 in. | 14 ft. 0 in. | 16 ft. 6 in. |
| Weight in working order (all on drivers) | 7,000 lbs. | 9,000 lbs. | 13,000 lbs. | 16,000 lbs. | 20,000 lbs. |
| Capacity of tank ... | 125 galls. | 150 galls. | 200 galls. | 250 galls. | 325 galls. |
| Hauling capacity on a level, in tons of 2,000 lbs. | 150 tons. | 200 tons. | 300 tons. | 375 tons. | 450 tons. |

It is recommended by the makers that for regular work, these locomotives should be used at one half their full capacity.

The machinery is enclosed to resemble an ordinary car, which having glazed sashes on every side, admits of an unobstructed view in all directions. The wheel base, it will be noted, is made short, so as to admit turning curves of short radii, such as are common on street railways. The use of anthracite coal or coke obviates smoke, and the noise of escaping steam is avoided by a patent quieter.

The makers say of them, "We believe this construction to be much preferable to a combined engine and car. As compared with horses, these locomotives are quicker in stopping and starting, faster, more powerful, and occupy about the same room. The gauge of track may be 36 inches, or the usual street railroad gauges of 56½, 60, or 62½ inches. The most serious objection to their use for hauling single street-cars in city streets is that their greater speed is not always available, except as gained by quicker stopping and starting, and the full economy of steam is not attained unless the traffic is heavy enough to offer a larger load than is usually carried in one car.

Where there are objections to the use of steam in the centre of the city, the road may be operated the first part of the way as a horse-car line, and the rest of the distance by locomotives. The ordinary street-car gauge may be retained, and the same cars run on the extension. A T rail is preferable to the flat street rail if there are no objections to its use."

And in a personal letter to us, they express the opinions that—

"The demand for street-car style of cabs wholly enclosing steam street motors is based on prejudice, and is a mistake. This kind of cab is expensive and unwieldy, and has nothing to recommend it. The claim is that as horses are used to street-cars, a locomotive exactly resembling a street-car

will not scare them. The fact is, that what scares horses is something coming up behind and overtaking them noiselessly, and without visible or audible explanation of what makes it go. Horses will jump sideways toward the curbstone every time, till they get used to the motor, which will not be long. Cable motor, compressed air motor, electric motor, or possibly a street-car pushed from behind will produce just as much effect on horses as a steam motor. A great deal of money is being thrown away on account of not using a little common sense about motors. Cables may be the thing in some services, as in large cities and crowded streets, or for great traffic, but steam motors are as good, provided they can have two or three cars to pull at a time, and to get the full benefit of the motor there should be some chance on part of the road for speed. Electric motors cost too much, and are so far experimental. The same applies to compressed air, hot soda, fireless and various motors. A steam motor is cheapest and best, and can be relied on all the time. Smoke consumers and steam condensers are not needed, and are expensive and don't amount to anything. The noiseless exhaust is desirable, but not necessary. Air brakes are no better than steam brakes, and cost more. Hand brakes are cheaper and ample for all practicable purposes in most cases. The simplest, cheapest operated and most reliable motor is the best."

ELECTRICAL RAILWAYS.

Inventors, manufacturers and capitalists appear determined to apply practically the modern developments of electrical science. Franchises for electrical roads are being sought and granted in the principal cities of the country, and there is no doubt that enterprise and genius will solve the interesting and difficult problem of practical application.

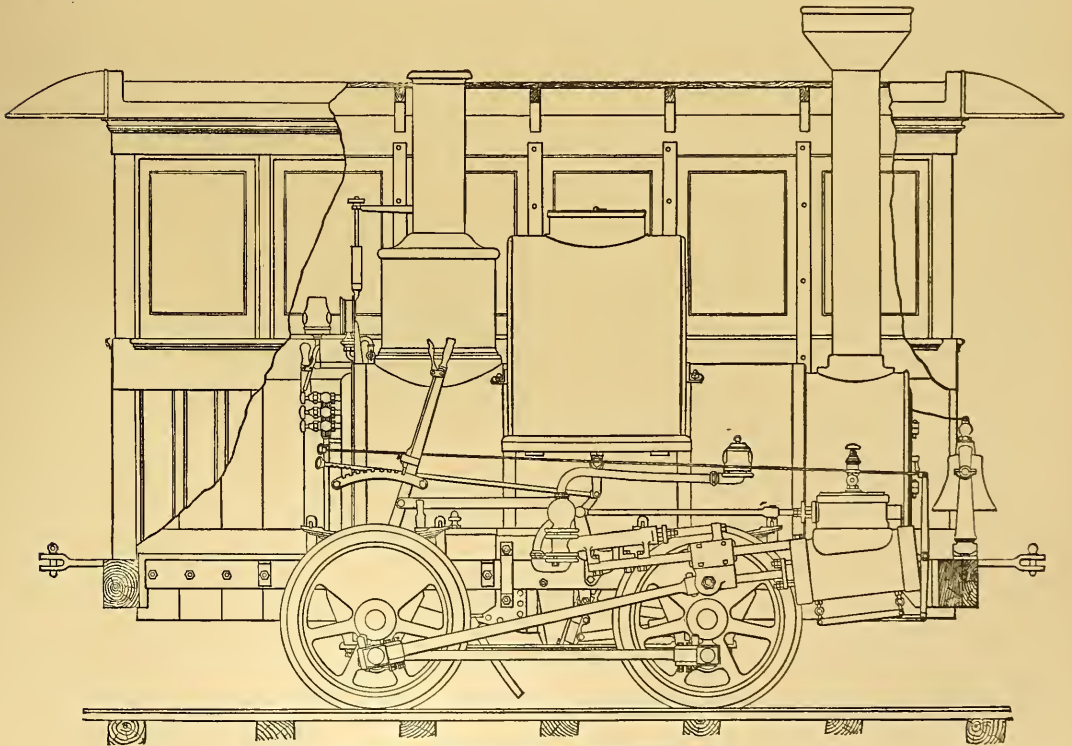

STANDARD STREET RAILWAY LOCOMOTIVE.

CONSTRUCTION, EQUIPMENT AND MAINTENANCE OF AMERICAN STREET RAILWAYS.

BY AUGUSTINE W. WRIGHT.

(Continued From Page 70.)

[By a very annoying blunder, the cuts alluded to in chapter iv. of this work (that on Joint Fastenings) were omitted

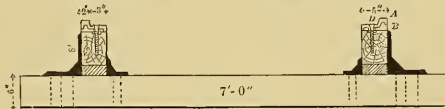

FIG. 1.

from their proper positions in our last issue. We insert them here, reprinting the accompanying text, which refers to them:

"I patented a joint fastening, as the result of my investigation, as follows: Chairs may be of steel, wrought or cast iron, corresponding in width and shape to the rail. Under the chair two or more nuts are let into the top of the stringer, beneath holes in the chair and rails. The chair is then put in place, on the stringer, over those nuts through which holes have been bored in the stringer of less diameter than the hole in the nut. Suitable openings are provided in the chairs to allow contraction and expansion of the rails. The rails are then placed upon the chairs and a bolt screwed through the nut into the stringer beneath. The nuts fasten the rail ends to the chair, and they are thus held level with each other. The bolt below the nut is screwed into the timber and fastens the complete joint to the stringer.

This construction renders the joint fastening independent of all shrinkage of the timber. Should the chair settle into the stringer from any of the afore-mentioned causes, the nuts beneath carry both rail ends with them and no jar results.

I have used several thousands of these fastenings and the tracks are quite smooth. The difficulty with them is that the nuts rust fast to the bolts, and the latter will have to be cut to loosen the rail when the time comes to make repairs. Having sold this patent, I have no pecuniary interest in its use.

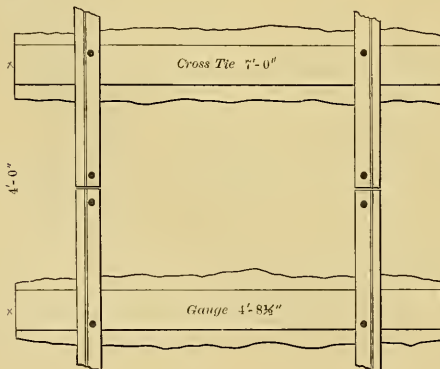

FIG. 3.

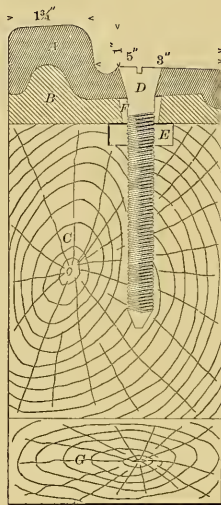

FIG. 2.

In the accompanying drawings, figs. 1 and 2 show my track construction in cross sections; fig. 3, a ground plan; fig. 4, top view of joint-chair. The letters all refer to the same parts in each drawing. A is the Chicago rail. Its extreme width is 5 inches. Head $1\frac{3}{4}$ inches at top, 2 inches at level of the tram, and the latter is 3 inches wide. Head is 1 inch above tram. It weighs 45 lbs. per lin. yard. B is the Chicago joint-chair of cast iron, 18 inches long, 5 inches wide, and weighing $15\frac{1}{2}$ lbs. C, the stringer; D, the joint screw; E, the nut fastening the rails to the chair; F, opening through the chair for the fastening; G, an additional timber put under the stringer when the rail joint does not come over a cross-tie, as described under the head of "stringers." In fig. 4 the lines at H and I show where the rails meet on the chair. The two slots are provided so that right and left chairs may not be required, for, as before stated, two-thirds

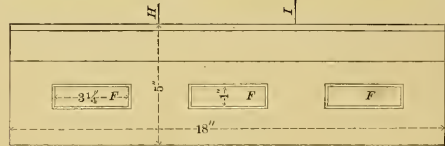

FIG. 4.

the length of each chair is placed under the rail against the traffic where cars pass only in one direction. The knees are shown, high outside, low inside of the stringer. The former weigh $7\frac{3}{4}$ lbs. The latter $2\frac{3}{4}$ lbs. The tee rail and all forms of girder rail allowing fish plates, afford better joints, a fact referred to in a future page.

VI.

SHAPE OF THE RAIL.

Having determined the material for the rail, its shape next merits consideration.

Unfortunately, the Street Railway Company is not permitted to select such form as it desires; but this is usually regulated and fixed by law so far as the upper surface exposed in the street is concerned.

The following are quite common forms of rails:

Figure 5 shows the rail used in Chicago. The municipal ordinance states the rail head shall be two inches wide

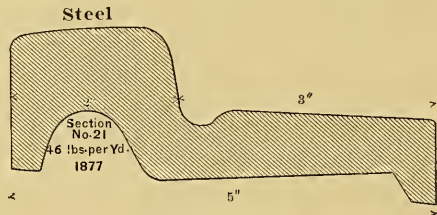

Fig. 5.

and the tram three inches wide, for use of the general public. The height of head above the tram is one inch, and the adjoining pavement next the head must be level therewith. This rail weighs 46 lbs. per yard.

Figs. 6 and 7 show a center bearing rail used in South

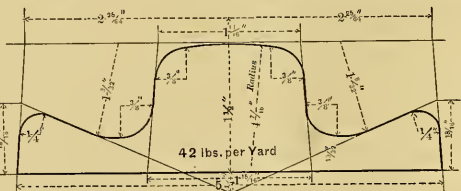

FIG. 6.

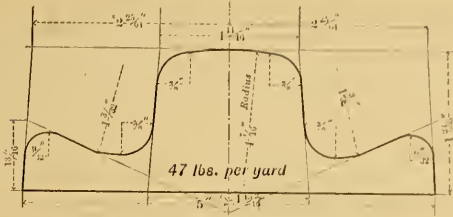

Fig. 7.

Boston, Louisville, New York City, Montgomery, Ala., Charleston, S. C., etc.

Figure 8. Center bearing rail, standard pattern, New

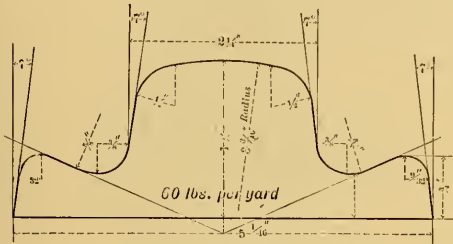

Fig. 8.

York City and Brooklyn.

Figure 9. Slope back rail. Used on steam street railroads.

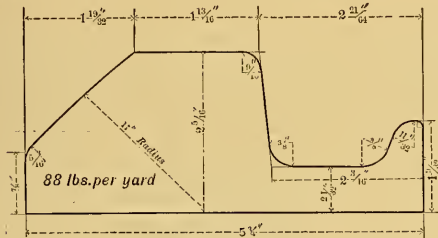

Fig. 9.

Figure 10. Standard Philadelphia rail. Used also in

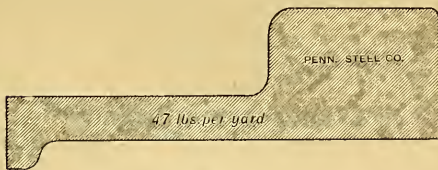

Fig. 10.

Baltimore, Providence, R. I., Jersey City, etc.

Figure 11. Used on some Philadelphia railroads.

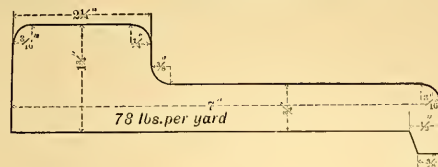

Fig. 11.

Figure 12. Slope back rail. Brooklyn City Railroad.

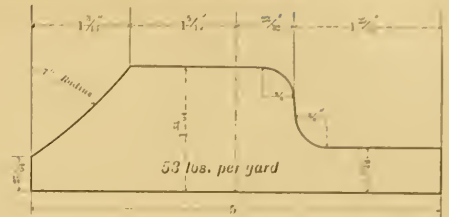

Fig. 12.

Figure 13. Standard pattern for Boston Street Railways.

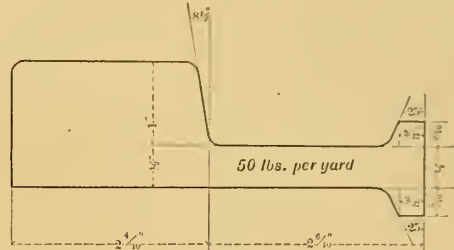

Fig. 13.

Figure 14. Used by the North Baltimore Railroad.

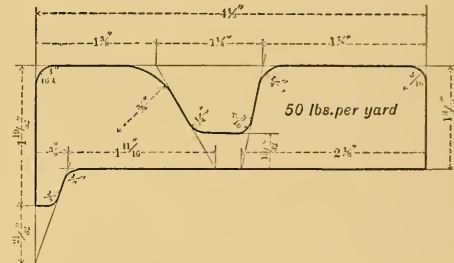

Fig. 14.

Figure 15. Used by Albany Street Railway Company.

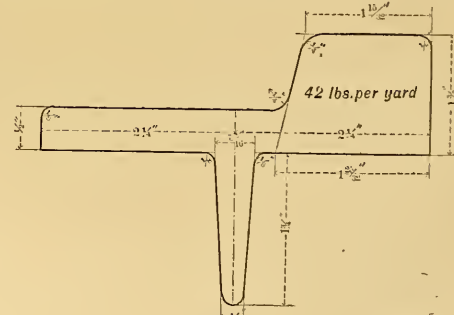

Fig. 15.

Figures 16 and 17. Standard grooved rails for curves. Used very extensively. I am indebted to the Pennsylvania Steel Co. and Wm. Wharton, Jr. & Co., both of Philadelphia, Pa., for these drawings.

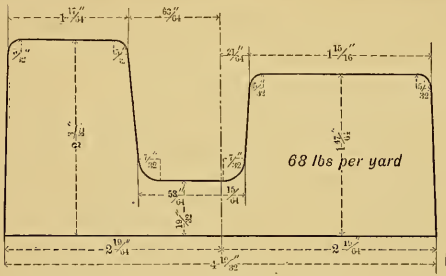

Fig. 16.

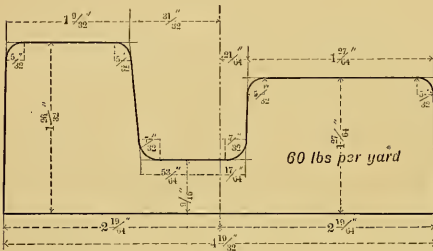

Fig. 17.

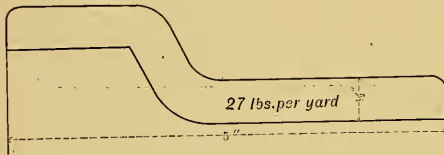

Fig. 18.

Figure 18. Used by Milwaukee railways and elsewhere.

TEE RAIL
19 lbs. per yard.

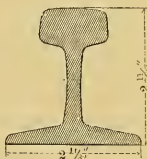

Fig. 19.

Figure 19. Tee rail, used on many roads in the smaller towns.

Figures 20, 21 and 22. A girder rail, made by the Johnson Steel Street Rail Co., Johnstown, Cambria Co., Pa., to whom I am indebted for the drawings. This girder rail is used so extensively, that I must omit to designate the various cities and towns.

I feel no hesitation in affirming that every street railway in the country would select the center bearing type from among these rails, if they were permitted to choose. Its advantages are as follows:

1st. Lessened resistance to progress. From information in my possession, I think 25% less power is required to keep a car in motion upon the center bearing rail, than upon a side bearing rail. The latter rail head is level with the adjoining pavement on the outside, and is usually covered with mud, sand, dirt, snow or ice. The center bearing rail, having the head higher than either side, is comparatively clean.

2nd. The weight of the car and its load is carried on the center of the stringer and does not tend to turn the latter

over, as in the side bearing pattern. This I do not consider of much importance, for it is not the car wheel that spreads our tracks! They are spread by the heavily loaded teams, turning out, as explained upon a previous page.

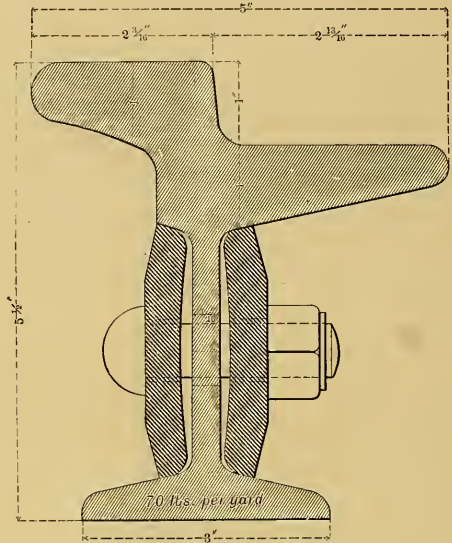

Fig. 20.

3rd. It can be, and is, more securely fastened to the stringer beneath. In the step rail, the spike holes are all in one side, through the tram. Every wheel passing on the tram, goes over the spike head and it is jarred and loosened, while the center bearing rail is spiked on both sides of its head and only half the spikes are subjects to these blows.

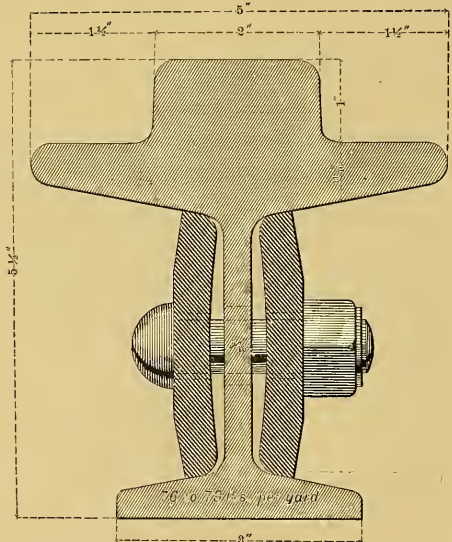

Fig. 22.

The disadvantage in the use of the center bearing rail is that it offers a poorer tram for the use of the general public, who seek the smooth way afforded by the street car rails, to an extent realized by few. I have upon a previous page, given you some statistics as to the relative travel upon the tracks of the North Chicago Railway and upon the balance

of the street, but have no statistics to prove to how great an extent heavily loaded teams leave side streets and travel along the rails. Now there can be no *cheaper pavement than steel or iron at present prices*. It is economy to maintain the adjoining pavement in such condition that the heavily loaded teams that *will* seek the car tracks, can get onto the rails.

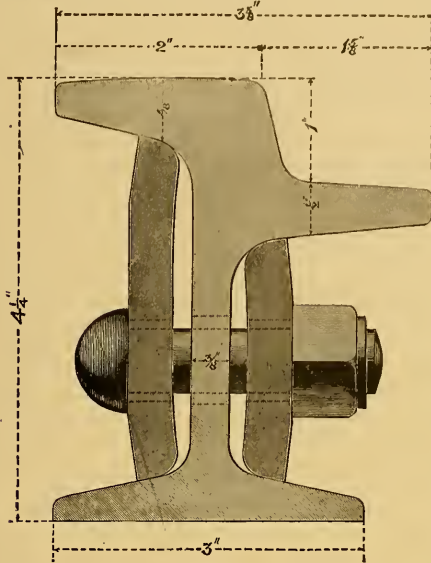

Fig. 21.

To the extent that the step rail affords a better wagon way than the center bearing rail, and saves the wear of the adjoining pavements, supposing they must be maintained by the Street Railway Company (which is the usual custom) is the step rail more economical, so far as track repair expenses to pavements are concerned; but there should be deducted an uncertain amount; the lessened teaming, that seeks the tracks when the center bearing rail affords a poorer tramway, and the decreased wear along the paving when the center bearing rail affords *two* narrow instead of one wide tramway for vehicles.

VII.

FASTENINGS FOR RAILS.

The usual custom in this country is merely to drive spikes through the tram, if the side bearing rail be used, or through each side of the head, if the center bearing rail be used. No street railway man needs to be told how wretchedly these spikes do their duty. In the former case, every spike head, and in the latter, half the spike heads are subjected to a blow from the wheel of every passing vehicle. The rails having little vertical stiffening, especially the former, vibrate under the wheels of every passing car and other vehicle. Water penetrates into the enlarged holes around the spikes, and decay adds to the mischief, making a bad matter worse. This vibration enlarges the holes in the rails, until, in four years time, street rails in my main track had hardly a hole through which my spike head would not pass. For this reason, it is my custom to spike through alternate holes, leaving one half, when new tracks are laid, for future use. The holes should be not more than twelve inches apart.

D. K. Clarke wrote: "A completely constructed tramway must, therefore, combine a perfect, unyielding, rolling surface, with a firm and durable pavement. The first condition—a perfect rolling surface—it was impossible to fulfill so long as the rails were fastened by vertical spikes or bolts passing through the groove in the rail." And again: "Moreover, the flat rail and the vertical spike or bolt fastening made a defective combination. It is scarcely necessary to

say that, at best, the form of the flat rail combined the maximum of material with the minimum of strength and stiffness, whilst the vertical spike fastening, though it is simple, and appears at first sight to have been happily devised, is deficient in strength and durability, and contributes nearly nothing towards the union of the rail with the sleeper (stringer). The rail, especially at the joints, is liable to spring, and the spikes, with their shallow, countersunk heads and limited bearing surface, are liable to yield and to wear; the spikes, in consequence, are gradually loosened, and the heads are lifted and torn or broken off. The spike heads are further exposed to damage from the wheel flanges, which, like the rail, become worn, ground in the groove, and occasionally split the rail. (This applies to the groove rail used in England.) Wherever there is vertical movement, of course an entry for water is made, pumping action ensues, and rain water alternately sinks through the spike holes and by the sides of the rails, and rises to the surface laden with sand and other detritus. The rails and sleepers are gradually undermined, the sleepers (stringers) are deformed by blows, and the vertical instability is by so much increased."

And again: "But a method of fastening the rail to the sleeper (stringer) was wanted, which should be free from the defects of the vertical spike—a method the barbarity of which was only rivalled by its simplicity."

American street railways have long recognized these facts, but it is only within a short time that the "girder rail" has been in the market.

(To be continued.)

HORSE POWER AND THE POWER OF A HORSE.

There is a great difference between these two terms. It is not always appreciated.

When the use of the steam engine began in England, it was largely employed to take the place of horses. A natural question asked Mr. Watt was, "What is the horse power of your engine?" meaning how many horses' work will it do.

To answer this question, Mr. Watt made experiments upon the horses used by the London brewers, and determined that these large and powerful horses could exert a force of 150 pounds at the rate of 2 1/2 miles per hour for 10 consecutive hours. Now, 2 1/2 miles = 13,200 feet. As the horse traveled this distance in 60 minutes (one hour) he traveled $\frac{13200}{60} = 220$ feet per minute. As he exerted a force of 150 pounds, we multiply the distance traveled per minute (*i. e.*, 220 feet) by 150 pounds and get 33,000 foot pounds, which has ever since been called H. P., or horse power, in rating steam engines.

The strength of a horse is considered equivalent to five men, yet for a short time a man can exert a "horse power."

In the transactions of the institution of civil engineers there appears "Experiments on the power of men," by Joshua Field, in which it is stated: "The greatest effect produced was that in experiment VI. This, when the friction of the machine is taken into account, is fully equal to a horse's power of 33,000 pounds raised one foot high in a minute. Thus it appears that a very powerful man, exerting himself to the utmost for two minutes, comes up to the constant power of a horse."

The force of 150 pounds can be greatly exceeded by a horse for a short time, and he can exert at least 10 "horse power."

As stated by me in a former paper on "Horse Power," instead of exerting a force of only 150 pounds, a horse can for a short time exert, by his experiments, 1,530.9 pounds Cressy estimates it at from 661.39 to 1,643.56 pounds; Haswell, 1,540 pounds.

You thus see that the "power of a horse," for a short time, and a "horse power," are quite different; as ten feet square and ten square feet. A horse power is the force that a large and powerful horse can exert, at a slow rate of speed for ten hours per diem, for *days in succession*.

Remembering the difference between these two terms may save some confusion in considering the power of motors for street railway service.

FARE COLLECTION.

The problem of the collection and proper registration of the fares collected on street cars is one of the most important that street railroad men have had to deal with since the introduction of that popular and now necessary mode of conveyance. It might be said that *everything* has been tried from "trust in the moral integrity of man" to the dropping of "nickels" by the passenger into a tin can, passed around by the conductor like a contribution box. But alas, no matter how honest a man might be, the temptation of making an extra little nickel has been too much for the "moral integrity of the conductor," and the desire of the average passenger to beat the road has proved too much for the contribution and fare box plans.

Therefore, various devices have been invented to keep tally or to register the fares collected by the conductor, attention being called to said registration by the sound of an alarm; the plan most generally adopted being the "spotter" or detective system; that is, the employment of men whose business it is to see whether or not the conductor registers all the fares collected, it being possible to "beat" any device by not registering. Therefore, it is natural to suppose that that device which renders this system the most simple and the most perfect, is obviously the best.

As Mr. Wright says in one of his valuable contributions: "The superintendent should, as far as possible, employ honest men, and having employed an honest man, 'lead him not into temptation.'" And just here comes in one of the most important factors in the selection of registers, and right here lies the superiority of the "blind" over the "open-face" registers. Say, for example, that you have hired an *honest* man. You give him an open-face register, no matter what kind. He gets into a big load, is a little new and green, becomes nervous, get "rattled," and at the end of the trip, or day, after figuring up his dial and counting out his run money, he finds he is fifteen cents over. What follows? Being an honest man, he reasons that the money is not his. But where did it come from? He either made a mistake in making change or he did not register. If the former, the money does not belong to the road any more than it does to him; but if the latter, it belongs to the road. Which is it? "Well, I do not want what does not belong to me. I'll send it in—but then if I do they will think I did not register those fares. That won't do. Well, I'll send it in anyway." That is his first fight with himself, and he conquers temptation. A few days afterward, he comes short twenty-five cents. The road insists upon collecting it of him. It might have happened in one of two ways; either he might have lost it in making change or otherwise, or else by getting "rattled" in a large load and registering too many fares. In either case he naturally reasons that if he is to be "docked" for what he is short he ought to keep what he is over. At any rate, the next time he comes over he keeps it. The fight this time is short, and temptation wins. Soon he comes a dollar short. He can not understand; he can not see where he could have made such a mistake. Then he comes short again and again. His pride will not let him send his reports in short. He makes it up, and the officials know nothing about it. Whenever he comes over he keeps it, just to even up a little. Then comes another temptation, worse and more dangerous than the first. Why not "knock down" just enough to keep him even? He has been losing money. He has come over evidently from forgetting to register, and the company did not find it out. He comes short again. "It is the last straw that breaks the camel's back." He becomes desperate, and your honest man "knocks down." Not being detected in his small stealings, he becomes bolder and more hardened. He easily keeps his reports even by figuring up his dial. His stealings increase and increase until—it is the same old story—your honest man is discharged, branded as a thief.

Take this same man, before he has been tempted, if you only could, and give him a "blind register." He has no fight with conscience, because he does not know when he is over. He counts out his own money and sends in the rest. Let his overs balance his shorts if they will. The time will

come, sooner or later, when a shortage will have to be collected. He may not know how it happened, and, perhaps, will think that he registered too many fares. A less honest man might endeavor to even up by "knocking down" a few fares. But how careful will he have to be to keep his report even with his dial. He must have a distinct knowledge, and keep an accurate account, of every time he collects three fares and only registers two. He must not attempt it too much or too often, or else his reports and his register will differ so frequently as to attract special attention.

As has been said before, it is generally acknowledged that the device is the best for registering fares which renders the detective system the most simple and perfect. To render that system the most simple, it is necessary that the device used should give the exact number of fares registered, on each and every car, separate and distinct, and also in such a way that they can not be changed or altered in any way whatsoever, after once being recorded. To render that system the most perfect it is necessary that the device used should keep the fares recorded in such a way that they can be filed away for an indefinite length of time, thus protecting the detective from being discovered. His reports being returned a day or two after being made, without his coming to the office or showing himself in any way.

For the past year the East Cleveland Railroad Company, of Cleveland, Ohio, has been using the Marshall register. It is a blind register in every sense of the word; no part of its registering mechanism being visible from the outside. It consists of a circular case (see the accompanying cut) a trifle

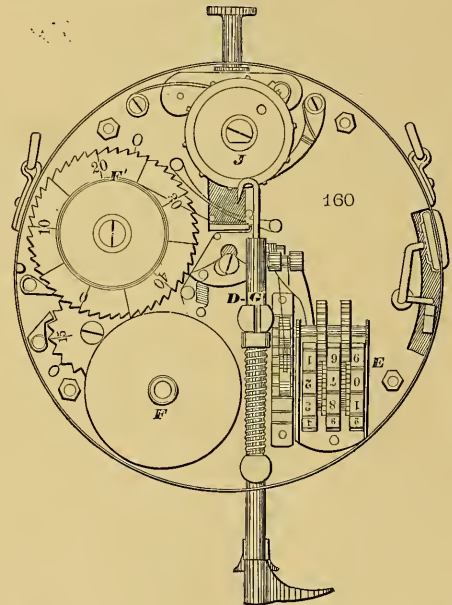

less than four inches in diameter, and weighs but eighteen ounces. The most important feature is the paper band contained therein, the rest being merely a means to an end. The paper used is the ordinary half-inch telegraph paper. It is wound on the roll F, and passes over an apertured table to the receiving roll F'. Disposed about centrally in the case are two bars, D and G (the bar D being behind G, can not be seen in the cut); the inner end of each of said bars being bent needles overhanging the apertured table over which the paper passes. These bars are so arranged as regards each other that the inner one, or D, can be operated alone, while on the other hand, the outer one, or G, can not be operated without causing D also to operate. The receiving roll, F', has a ratchet wheel with fifty teeth, and is graded or marked off so that each tooth counts for one. This wheel,

in connection with a smaller wheel, arranged in such a way as to count one for every revolution of the larger one, forms a register or dial on the scale of fifty. J is a wheel with numbers on its periphery, and is used for keeping a record of the number of half trips run or cars collected. Every time it is pushed down it imprints a number on the paper. Every time the bar or rod D is pulled or operated it causes the alarm to sound, punctures a hole with its needle end in the paper, and by moving the receiving roll F' one notch registers one fare on the dial and presents a new surface of the paper. When G is pulled, by compelling D also to operate, it accomplishes all that D does, besides puncturing an additional hole by the side of that made by G, and registers one on the decimal dial E. Thus, after a few trips have been run, we have a paper looking like this: —

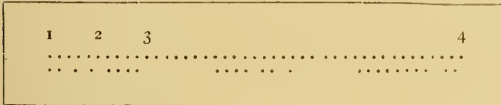

As will be readily understood, the inner or continuous row of holes was made by the needle on the end of D, and represents the total number of fares collected, and will agree with the number of fares registered on the dial, F'. The outer or broken row of holes was made by the needle G, and represent the number of tickets (as used on the E. C. R. R.) collected, a tally of these being kept on the decimal dial E. Of course, the difference between the tickets and the total will be the cash fares collected. The numbers 1, 2, 3, etc., on the paper represent the number of cars run or collected. Thus giving the number of fares collected on each and every car, separate and distinct, and in a manner that can be kept forever, if necessary, without danger of ever being disputed or altered, even in the office. Thus, on the third car run on this register, there were 32 fares collected, 17 of which were tickets and 15 cash. It is almost needless to say that as the register F' keeps a tally of all the fares registered, and as E of all the tickets, it is unnecessary to count the holes in the paper to ascertain whether the conductor's report is correct or not, reference being had to the paper only when ascertaining the number of fares collected on some one car, as when comparing the detective reports or for proving the register against a mistake in setting up.

The only necessary book entries are the totals, as they appear on the registers, and their differences.

The accompanying diagram will show the method in use by the E. C. R. R. Co. The entries for days are across the

On the same day W. Marlan runs register 14, seal 257. His dial calls for 610 fares, 143 tickets, and 467 cash. He returns \$22.35, that is 447 cash fares, 143 tickets, making a total of 590. He is exactly one dollar short in cash. Say nothing to him, but await the morning. On the 18th Sam Riggs is again correct, but has evidently registered one ticket as a cash fare, being one cash short and one ticket over. Marlan is one dollar over in cash, but one ticket short, leaving him 19 total fares over. From all appearances he made a mistake of one dollar on the 17th in making out his report. Knowing nothing about it, however, he turned it in the next day. If he had not it would have been collected. On the 19th Riggs is again correct all around, while Marlan is one ticket over, making him exactly correct for the three days. If the two men keep on as they have been doing, it is safe to say that Riggs is much the better man of the two. If a man comes short continuously, collect and have your detectives pay him special attention. If a conductor comes over continuously, you know for an absolute fact that he is not "ringing up" all his fares, and you have no further use for him.

To facilitate the looking up of detective reports, the conductor is furnished with report blanks, the back of which is arranged as shown in the accompanying diagram:

| | Car No. | Time | Half Fare | Schools | U. I. | Employes |
|--------|---------|------|-----------|---------|-------|----------|
| W..... | 1 | 16 | 6:00 | --- | --- | --- |
| F..... | 2 | 16 | 6:30 | --- | --- | --- |
| W..... | 3 | 24 | 6:55 | --- | --- | --- |
| E..... | 4 | 24 | 7:25 | --- | --- | --- |
| W..... | 5 | 26 | 7:50 | --- | --- | --- |
| E..... | 6 | 26 | 8:20 | --- | --- | --- |
| W..... | 7 | 18 | 8:45 | --- | --- | --- |
| E..... | 8 | 18 | 9:15 | --- | --- | --- |

He is obliged to put down the leaving time of every car, together with the car number; also the number of half fares, school tickets, passes and employes, whenever he has any. For half fares the cash register is used, two cents being allowed for each one marked down. As every employe and holder of a pass is furnished with special tickets, these, together with the school tickets, are registered on the ticket dial. Thus the conductor has something to show for every person who rides upon his car. The detective is furnished with a blank, on which he fills out the conductor's number, car number, the time and direction of said car, where he gets on and off, and the number of passengers on said car. For example, he sends in a report as follows: "Conductor, No. 2; car, No. 24; time, 7:25, east; on at Bank, off at Kennard; passengers, 34." By referring to conductor number two's report we see that car No. 24, at 7:25, east, is his fourth car. By referring to the paper taken from his register we find that there were 34 fares registered on the fourth car. Comments are unnecessary. H. A. EVERETT.

AROMATIC CAR HEATERS.

If any one of late years has proven himself thoroughly deserving of the *cordons bleu*, it is the inventor of the device which a daily exchange mentions as follows:

"The last experiment in heating street cars was made with an aromatic carbonic composition, which not only sends the temperature bounding upward but fills the car with a peculiar fragrance. The stuff resembles coffee and will prove of decided advantage to some of the patrons of the south side lines if it comes into general use. Besides counteracting the odor heretofore peculiar to the vehicles it imparts a spicy smell to the clothing which neutralizes the fumes of tobacco and prevents detection of the lingering traces of the weed among those whose office duties compel close application until late at night. As a producer of domestic harmony the aromatic heater has no superior. The night cars should be supplied with an extra quantity of the fuel."

Here at last is an invention which soars high above the commonplace, and in this "age of mediocrity, with its thousand gigs" (to use Carlyle's forcible phrase), anything above the dead level of mediocrity deserves applause. How much more than is such an invention as this, combining utility with

| 1886. | | SAM. RIGGS | | | | W. MARLAN. | | | | |
|---------|-----------------------|------------|-----------|----------|-------|---------------|------------|-----------|----------|------|
| Date. | No. and Seal. | Fares. | Run Cars. | Tickets. | Cash. | No. and Seal. | Fares. | Run Cars. | Tickets. | Cash |
| Feb. 15 | Dial. 19 Rept. 256 | 519 519 | 24 | 107 | 412 | 14 | 610 590 | 30 | 143 | 467 |
| | | | | | | | 20 short. | | | |
| 16 | Dial. 13 Rept. 223 | 613 613 | 24 | 126 | 487 | 10 | 593 612 | 30 | 156 | 457 |
| | | | | | | | 19 over. | | | |
| 17 | Dial. 19 Rept. 132 | 427 427 | 24 | 96 | 331 | 14 | 483 484 | 30 | 122 | 361 |
| | | | | | | | 1 over. | | | |

page, the record of the men being down the page. Thus, on the 17th of February, 1886, Sam Riggs used register 19, in which was placed seal 256. The register on being opened read, large dial, 519; small dial, 107; the difference, 412, being the cash fares called for. He turned in, in his report, \$20.60 in cash at 5 cents=412 fares and 107 tickets, which, added together, makes 519, the total called for by his register. His trip or car marker, as shown by the paper in his register, has registered 24, the number of cars called for by his run. His day's work is correct in every particular.

luxury, humanity with elegance, wedding use with beauty—how much more, we say, is such an invention worthy our highest praise.

The car-heater *per se* has had a "hard row to live" through the barren fields of corporate conservatism, as every ambitious advocate of such devices can testify. Indeed, there is something disheartening in the perversity with which the average street railway superintendent refuses to spend his company's funds for the purpose of convincing Professor Backweidschnabelbein, that his "Patent Duplex Interchangeable Winter and Summer Car Heater and Refrigerator" is a colossal failure. Truly, in matters related to car-warming, his *won't* is as hard as Pharaoh's heart.

Note now the subtle delicacy of conception with which this diplomatist takes by strategy, the stronghold that the allied forces have vainly assaulted since "way back." The ordinary street car is not a savory affair, and no one is more painfully aware of this fact than the street railway official. He considers the car-heater question a snare and a delusion, and car-heaters,—such as he has seen or tried—a costly, uncertain and unnecessary luxury. Still, he would not object to heating his cars if he could do so without breeding disease, or adding to the causes for grumbling among his patrons. But he *is* anxious, with an anxiety, deep, persistent and pathetic, to have his cars perfumed, or at least deodorized. It is the one thing he lies awake o' nights to think about, and it is the one subject which brings the grey hairs of generation after generation of him, broken-hearted, disappointed and crushed, to an early grave. This fact is not generally known to outsiders, but now, since this inventor has discovered it, there is no breach of trust in our letting the secret out to all.

Fortunate inventor, what a future opens before you! Could the dying eyes of the ambitious De Soto, as he looked from the bluffs below the site of Natchez, across the lordly river rolling at their foot, have foreseen

* * * "the vision of the world and all the wonders that would be"

in this great West, the possibilities opened before him would have been slight and narrow compared with the elysian future that unrolls before our mind's eye for this "aromatic car-heater."

But, for the prospects of the immediate future: the odor of stale tobacco smoke, or yesterday's expectorations, yielding to the balmy scent of *New Mown Hay*; the pervasive and pungent odor characteristic of the horse or mule, wafted "out of entity" on the tender breath of the *Wood Violet*; the self-asserting aroma of the freshly fish-oiled cow-hide boot, over-borne and extinguished by the delicate but decided scent of *Marie Stuart*; the sodden and belated fumes of long mown salt-marsh hay, succeeded by the luxurious perfume of *Patchouly*; the dank smell of forgotten straw, replaced by the oriental fragrance of the *Musk*; and the ever-present stench of bad whiskey and worse garlic, subdued, vanquished and annihilated by the patrician odor of the *White Rose*. And so we might run on, yielding the reins to our yearning fancy, through a category of all the "odors of Araby the blest."

As we proceed, the possibilities of the invention continue to unfold in alluring prospects. All persons do not affect the same perfumery; so it could easily be arranged that the straight-banged devotee of *Musk* or *Patchouly* should be entirely independent for her enjoyment, of the languid patroness of *White Rose* or *Marie Stuart*; while the slab-sided, straight-haired champion of *Bergamot* could avoid in oblivious delight the effeminate proximity of the dudeling "adawah" of *Violet*, *Jockey Club* or *Ylang-Ylang*, simply by having cars variously perfumed, and designated by inscription or color, so that the intending patron of the *Heliotrope Car*, could not possibly make a mistake and board a *Patchouly Coach*.

To make assurance doubly sure, the cars might be named, and the sleeping-coach companies' monopoly of poetical railroading be thus broken. Instead of such names as the "Gazelle," "La Favorita," "El Gobernador," etc., affected for sleeping-coaches, we might have on the body panels of our street-cars such titles, at once poetical and indicative of

their character, as "Night Blooming Cereus," "Jockey Club," "Stephanotis," "Wild Olive," etc.;—names and perfumes which would add a poetry to locomotion, never dreamed of by the writer of the Arabian Nights.

The cars could also be alternated to suit the ascertained tastes of passengers,—thus, two *White Rose* cars could be run against a single *Musk* or *Heliotrope* car; and for the benefit of such as can not read or might be unfamiliar with the fact that the blue car is a *Heliotrope* car, and the red, a *Musk* car, the conductor, on receiving a signal, should vary the usual formula with something like this: "*Carnation*, madam—Dublin avenue?" And on the lady's answering, "Jockey Club," he might pull the bell again, and call back, "Green car, second car back!"

Here, too, is a chance for advertising which would beat Tom L. Johnson's white six horse teams, and baseball parks all hollow: think what a hold that line could gain on popular favor which should be always first to introduce a new perfume in its cars and which might advertise its "bob-tails" as the "temples of taste and fashion in perfumery."

Thus we might run on developing the invention; but we have said enough for the present. Perhaps we shall take it up again in the future.

"HORSE AND MAN."

We omit from this issue the continuation of the review of Rev. J. G. Wood's book, as the publishers, J. B. Lippincott & Co., Philadelphia, have kindly consented to furnish us the illustrations, which will be ready for the next issue of the GAZETTE.

THE HAYCOX DOOR FASTENER.

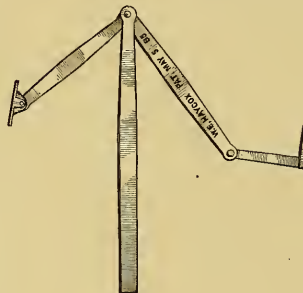

FIG. 1.

The illustrations herewith show in detail and in operation a recently patented door fastener, which, since its invention, last May, has been adopted on some of the most prominent street railroads of the country.

The engravings are so lucid that but little description will be necessary.

Fig. 1 shows the fastener proper in detail. It is made of malleable iron, and weighing about five pounds, does not interfere with the easy operation of the door. The bracket to the left is fastened by screws to the car framing, and the one on the right, to the edge of the door.

Fig. 2 shows the fastener in operation, with the door closed. The weight suspended from the center of the joint, acts to hold the door in this position.

Fig. 3 shows the door opened, and the gravity of the weight, so disposed by the combination of joints as to hold the door in this position.

In actual use, of course, it is invisible,

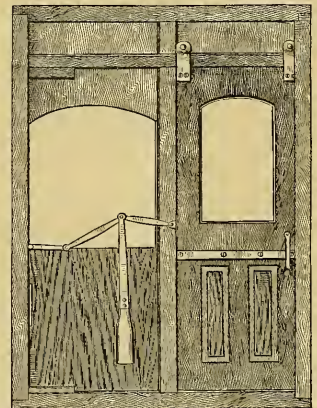

FIG. 2.

as it is placed in the open space between the inner and outer panels of the end framing, in the space occupied by the door when open.

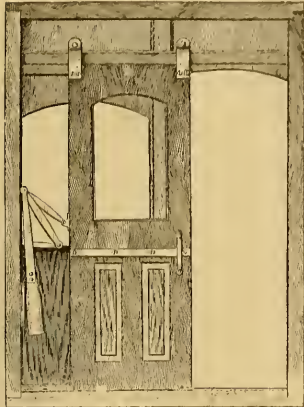

FIG. 3.

It can be attached readily to old or new cars without alteration in or disfigurement of the woodwork. It is thought to be of especial value in heated cars, where it is desirable to keep the doors tightly closed, though its convenience in any case is apparent at a glance.

Its simplicity of construction renders it unlikely to get out of order, and its situation makes it an easy task to apply or remove it.

RAMSDEN'S CABLE RAILWAY CONDUIT.

We illustrate herewith in cross section, a newly invented cable conduit, on which a patent has been applied for. It consists of a cast iron piece, which the inventor calls a "yoke," extending across the street, and carrying on its outer ends stringers, to which the rails are fastened. It is proposed to use nine of these yokes to every two lengths of rail. The sides and floor of the conduit are formed by planking bolted to the yokes, which are laid in concrete. The slot is formed by two string-pieces, or timbers, faced on the top and sides with iron plates. The timbers are pinned to the iron yoke on which they rest, and can be adjusted so that expansion and contraction will not affect them.

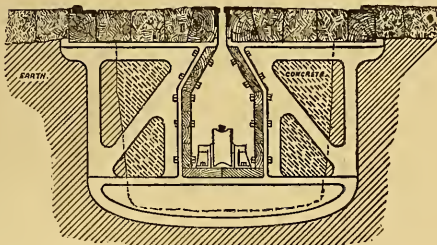

RAMSDEN'S CABLE CONDUIT.

The points of merit claimed by the owners are, economy in cost of construction; strength, and durability; their construction in parts, which permits economical handling and transportation; absence of liability to be affected or displaced by changes of temperature, etc.; and ease with which the plank lining of the conduit can be renewed. The rails are spiked to the stringers, as usual. The slot irons are secured by spikes or bolts to the stringers in such manner that they can be readily adjusted apart as required and without disturbing the road-bed of the track.

RAMBLINGS IN DIXIE.—II.

BIRMINGHAM, ALA.

When last in "the Pittsburgh of the New South," the writer had the pleasure of meeting Dr. H. M. Caldwell, President of the Elyton Land Company, who is now giving considerable attention to street railway matters. The aforesaid corporation owns several thousand acres of land in the immediate vicinity of the city, and, in order to induce build-

ing, has constructed a street railway through a portion of these lands. Beginning at O'Brien's Opera House, on the corner of 19th Street and 1st Avenue, near the business center of the city, a double track extends along 1st Avenue to 22d Street, thence by a bridge, 1,000 feet long, spanning the L. & N., the C., N. O. & T. P., and the G. P. railroad—passing over, also, Morris and Powell Avenues—it reaches Avenue A, whence it continues along 22d Street to Avenue E. At this point the two tracks diverge, one westward, to 15th Street, then along 15th Street into the Highlands; the other eastward, to 27th Street, thence *via* Lakeview Park and Poplar Spring, as well as into the Highlands, to a connection with the other line. The two lines thus form a loop, or belt railroad, six and a half miles long, belting the Highlands, bringing into market many handsome building sites, and constituting some of the most delightful suburbs to be found contiguous to any city in the country.

The line, after leaving the city, penetrates the foot hills of the famous Red Mountain, rising, by easy grades, to an elevation of from 200 to 300 feet. Skirting these foot hills, winding over high ridges, and bending around precipitous slopes, sometimes in full view of the "Smoky City" and green valley below, the scenery is delightful.

One of the principal attractions of this line is Lakeview Park, embracing about sixty or seventy-five acres, which, well adapted by nature to the purpose, has been improved and adorned at an expense of \$15,000 to \$20,000. An artificial lake for boating has been constructed, supplied with pure water conveyed in pipes from a number of mountain springs. But boating is not the only amusement provided. At one end of the lake a large and ornate building has been erected for use as a dancing hall and refreshment room. In the basement of this building is also a swimming pool, 50x100 feet, while there are bath-tubs and shower-baths in abundance. On the adjacent hillside are being erected a number of summer cottages, for the accommodation of Birminghamites.

The line known as the Highland Avenue Railroad was constructed to boom real estate, and has been, in that respect, phenomenally successful. But more than this,—during its first seven months of existence, its expenses exceeded the receipts by only about \$15, notwithstanding almost the entire route, after leaving the city, is through the woods.

Construction commenced in May, 1885, and was finished in July of the same year, the first car passing over the road on July 1; seven cars, some made by the John Stephenson Co. and some by Brill, are used; the cost of building the line, together with its equipment, was in the neighborhood of \$27,000. The average passenger receipts per month have been about \$300, which will be largely increased this season, as the resorts become better known.

The line has been well built, using thirty pound T rails, made by the Birmingham Rolling Mill Co. Mules, at present, furnish the motive power, but a contract has been made with the Baldwin Locomotive Works for small locomotives to be used in their stead.

And among other improvements, I understand that a five story, modern hotel is to take the place of Dr. Caldwell's handsome residence, at the head of the bridge, on 1st Avenue and 22d Street, to be constructed by the Caldwell Hotel Company.

A BRIGHT IDEA.

An old street railway man, when commenting upon the increasing tendency for strikes among drivers and conductors, remarked: "If we could get married men, exclusively, to do the work, there would never be any strikes; a young, single man will gamble on chances which a married man will sleep over and discuss with his wife, who invariably advises against creating trouble with his chief, fearful lest he should be thrown out of employment.

While it would appear hard to discriminate against those who are not lucky enough to be possessed of wives, may there not be, in this, the nucleus of a solution of the great problem of capital and labor? Think it up.

THE
STREET RAILWAY GAZETTE

APRIL, 1886.—MONTHLY, \$2.00 PER YEAR.

COPYRIGHTED APRIL, 1886.

WRIGHT, MONROE & CO.,
PUBLISHERS.

GENERAL OFFICES:

NEW YORK, - - - - - 40 Cortland Street.
Geo. B. Heckel, Resident Editor and Manager.
CHICAGO, - - - - - 12 Lakeside Building.
P. G. Monroe, General Manager.
E. V. Cavell, Business Manager.

Augustine W. Wright, - - - - - Editor in Chief.
Robert Grimshaw, - - - - - } Associate Editors.
Henry C. Lockwood, - - - - - }

BRANCH OFFICES.

Philadelphia, Pa., 105 N. 4th St., J. Waterkeyn, Manager.
Cincinnati, 175 Vine St., Frank Trainor, Manager.
Pittsburgh, Pa., James Loughran, Manager.
St. Louis, Mo., 709 Olive St., Frank W. F. Scholl, Manager.
Atlanta, Ga., Chamber of Commerce Bldg., Wm. Minningerode, Mng'r.
St. Paul, Minn., 553 Drake Block., V. R. Benham, Jr., Manager.
San Francisco, Cal., 1322 Pine St., G. W. Fairchild, Manager.
New Orleans, La., J. P. Brady, Manager.

LEGAL DECISIONS.

Several correspondents have suggested that we should publish legal decisions in our columns. It has been our practice to do so, to a limited extent, and we will, in the future, pay more attention to the subject. Such matter will usually be found among our "Pointers" (which, by the way, are, every one of them, worth reading). However, our advice to those wishing to be kept thoroughly posted in this department, is to join the American Street Railway Association, which makes a specialty of its legal reports. The Association is doing much valuable work in this and many other directions, and we do not wish to conflict with it in any way.

A SOLO ON A NEW HORN.

The Book of Mormon is credited with this remarkable text: "If a man bloweth not his own horn, by no man shall his horn be blowed." Now, acting on this worldly-wise hint, we think it is high time for us to do a little blowing on our brand new horn; to give the key, as it were, to the orchestra waiting to take up the strain.

THE STREET RAILWAY GAZETTE is now more than a quarter of a year old, this being its fourth public appearance. It may sound boastful, but we think we do not overstep the bounds of strict truth in saying that the first number of the paper was a very good one, and that each succeeding number has been an improvement on the one before it. We did not brag very much at the outset, and so have been able to do something more than merely keep our promises. We said we would do the best we knew how to do, and have found ourselves able to do far better than we hoped for, if the reception we have met with is any gauge of merit.

Starting with the sole definite policy of being useful to the interests we wished to represent, we have watched our opportunities and have tried to make the best of them. No important measure or incident has been overlooked, and where opinion or criticism seemed to us advisable, we have made our comments freely and frankly. Intending that the GAZETTE should be valuable to the street railway man, we have devoted its columns to the interests of such, and have

allowed nothing in the nature of mere advertising to creep into them. It is true, we confess, that in adhering inflexibly to this rule, we have lost some patronage, but we expected as much, and we are contented that it should be so; and not in the least fearing the final results of such a policy, we intend to adhere to it even more strictly in the future. Such a course, we are convinced, is the only sure way of getting and holding an audience for ourselves, and, therefore, an audience for our advertisers. This is not, as we are fully aware, the commonly accepted plan of class journalism, but then class journalism of a certain sort has sunk to a very low level, and if we can not find a hearing on a higher plane, we would vastly prefer to drop the matter altogether, convinced that for purposes of mere advertising the plain business circular is preferable to the catalogue of puffery, commonly known as a "trade journal"—besides which, the circular is honest, and claims to be nothing but an advertisement, while the journals of which we speak, masquerade under false titles.

To our readers, therefore, we promise constant and steady improvement; we will obtain and publish the most valuable information that is to be had on topics of interest to them, and we will have and publish *opinions*, right or wrong, which we shall not fear to print. Where our opinions are correct they may be useful, and where they prove erroneous, we know that they will be met with the frankness their candor deserves, and we shall be pleased to publish exceptions and to acknowledge errors.

Our columns are open, as they have been from the start, for anything belonging to the field of street railroading, excepting puffs or trade circulars, and in this line we can do no more for our advertisers than for any one else. We are pleased to receive and publish information respecting new and useful devices, but only in the way of description and comment, and never in any form remotely related to the advertising of such, excepting so far as a detailed explanation necessarily involves a certain amount of advertising of a device.

It will be understood from this, that we were in earnest when we promised to make this a high-class journal, devoted to the interests of street railways.

This is our solo, and, though the horn is new and hitherto unused, we trust that its tones will be found not lacking in the proper quality.

LABOR DISPUTES.

No one objects to combinations of labor for legitimate, legal and proper purposes, but lately the Typographical Union of Newark, N. J., has taken a position that is brutal, cruel and tyrannical. It served notice on the *Daily Advertiser* of that city, that seven men who were employed in the office of that paper, including one who had been in its service forty years, would not be admitted into the Union, because they had abandoned a strike in which the office was involved about five years ago, when they returned to work without permission from the central authority. The object was to make the office an union office, in order to punish these men for acts committed five years ago. The proprietors refused to comply. The *Advertiser* was boycotted. The matter got into politics, and a blatherskite alderman offered a resolution in the common council, reciting that whereas the *Advertiser* by the continued employment of non-union men, had "arrayed itself against the interests of organized labor," hereafter no city printing should be given to the paper. The discussion was interesting. "I am myself a working man," said Mr. Dusenberry, "but I don't believe in any such course as we are asked to pursue." Mr. Denman followed in a forcible speech. "When this body," he said, "is asked to vote to injure working men, against whom no other offence is charged save that they do not belong to a certain society, they ask us to do an injustice, and any man who votes in accordance with such demands merely to curry favor is not worthy to hold a position of honor and trust." The promoters of the resolution should recede from their position, which is both untenable and wrong.

On the other hand the course of the employés, who, in

the city of New York, have recently conducted strikes against street railways, have displayed considerable moderation and judgment. It is sincerely to be hoped that the success which they met with will not turn their heads, in the future, and induce them to make unreasonable and unjust demands. In the negotiations that ensued, reason and discretion were exercised both by the employer and employé; by labor as well as by capital. The fact is that the principle of arbitration in labor disputes is fast becoming understood and appreciated. It is the substitution of reason for force. Strikes by workmen, and lockouts by masters are only the arguments of coercion. Arbitration has had a slow growth in this country, while it has long been fully established in France, where councils were created in 1806 to decide disputed questions of this character. Six of the council are chosen by the workmen and six by the employers and the president of the body is selected by the government. The decision has a legal force. There are now about one hundred and fifty of these councils in France. The best work they do is through a committee of the council, which is always ready to take conciliatory measures, before a formal appeal is necessary. In this way 95 per cent. of the disputes are settled. This system has been successfully introduced into Austria and Belgium, but not in England. However, laws of this character have been passed in Pennsylvania and Ohio. It is only remarkable that this mode of arbitration is not more popular in the United States.

Universal suffrage gives great power to the masses, and the fear is that they will be led by unscrupulous men, into positions which are not supported by reason and justice. Education in and knowledge of economical questions, should accompany this voting power. The principles of arbitration and conciliation have made great progress in the settlement of differences between capital and labor. Productive co-operation, another great force for the amelioration of the people, has been quite successful in many parts of Europe. Profit sharing is another means of uniting and blending interests, that seem to be conflicting. These systems require careful, intelligent and peaceful consideration. Warlike and aggressive movements are wrong and unjust, and will certainly react disastrously on those persons who may promote them.

[Since the above article was written, many events—an account of which has appeared elsewhere—have taken place in the city of New York that very materially modify our conclusions as to the justice, conservatism and moderation of those who direct the course and shape the conduct of the thousands employed by the street railway companies of that great city.]

CORPORATIONS, FIRMS AND INDIVIDUALS.

Some keen philosopher has observed that a lie has only to be repeated often enough, to be accepted as undoubted truth. Such a lie is the often-quoted saying (with its implications) that "Corporations have no souls." It is never said that mercantile firms, or individuals engaged in business, have no souls, though there is no difference between these and corporations, except that the latter have legal limitations and responsibilities imposed upon them, which are unknown to the others.

A firm is a number of individuals, associated under certain mutual agreements, for the purpose of carrying certain enterprises. These are individually responsible to each other, and to those with whom they have dealings. They may terminate their relations at will, or change the business in which they are engaged.

An individual in business is, as it might be stated, a firm with one member.

A corporation is an association of individuals, having a definite legal existence, for a certain legally-defined purpose. It is limited in its object and transactions, in its financial standing and responsibilities, and in all its functions. On the other hand, its character, relations and responsibilities remain unaltered with any changes among the individuals composing it, and no matter who may die, or who may

assume control of its government, it always remains defined, responsible, and limited on every side by law and precedent.

Such is a corporation, legally defined. It is a fictitious person. But the corporation, as it exists in its relations to the public, is an association of individuals, presumably possessed of equally as much intelligence and conscience as falls to the lot of ordinary individuals. Its actions are the actions of the persons composing it, or employed by it; its sins are visited on the heads of these, and its virtues belong to them.

It is the confusion of the fictitious and the actual nature of corporations, which renders the lie above mentioned such a specious one.

Now, we are free to assert, without fear of refutation, that more injustice and wrong is done by individual business men and unincorporated firms, and less restitution is made for such wrong in the United States than by all the corporations therein. Furthermore, we are sure that more injustice is done against corporations than by them. Public (and, indeed, private) morals are unaccountably lax on points touching corporations, and the man who would not dream of eluding payment for a paper of pins will, with perfect equanimity and an indifferent conscience, fail to pay his fare in the street car should the conductor chance to overlook him, and persons into whose heads it would never enter to help a grocery clerk in speculation, do not hesitate to shield the street-car conductor in "knocking down."

The assertion that corporations suffer injustice, we do not consider a random one; and of these, railway companies have more than their due share of such injustice to stand. On the one hand, such corporations live by their popularity, and so unjust is the popular prejudice against them, that it always sides with their accusers, without evidence; hence, it is usually considered politic to make concessions so long as the demands are not ruinous, in order to avert the greater evil of public misjudgment. On this account nearly every railway company keeps an attorney, or claims agent, whose duty it is to compound intended suits as cheaply as possible, rather than to let them come into the courts and so before the public, which is always certain to consider the corporation in the wrong, irrespective of the decision. In this way thousands of dollars are expended annually in settlement of claims that would not hold in courts of law.

As an instance of the blind prejudice which always places the public in the opposition when it is a case with a corporation, we may recall the Chicago street railway strike, in which the populace, nearly to a man, sided with the strikers; and even now, ignorant of the fact that a jury of the strikers themselves have since sustained the railroad company in its decisions regarding most of the cases then in question, the Chicago public still lays all the blame for that trouble upon the West Division Company. In St. Louis the only thing that prevented a repetition of the same state of affairs, was the fact that the strikers foolishly used dynamite, and therewith frightened the public into opposition.

We beg leave to amend the proverb, and instead of saying that "Corporations have no souls," say that "The public have no soul, nor conscience."

THE SAME CANOE.

Our esteemed friend, the *National Car and Locomotive Builder* differs with our conclusions in the editorial entitled "Unions" in our January issue, and comments thereon as follows:

"THE STREET RAILWAY GAZETTE thinks it is a strange and unnatural thing that the relations between the conductors and drivers of street cars should involve, as they almost invariably do, so much mutual confidence, sympathy and support, the conductor flying to the rescue of the driver, and the driver to the assistance of the conductor when either gets into trouble with the company. To our mind there is nothing strange about it at all; but on the contrary quite the reverse. Conductor and driver are both in the same canoe, or car rafter, and a fellow feeling makes them wondrous kind. And why not? The difference in point of dignity between their respective functions, as compared with the chasm which separates them both from the corporation which employs them, is as the difference between grains of sand, and the rock of Gibraltar. Both conductors and drivers are, as a rule, overworked and

underpaid, and as for either of them ever becoming so delirious as to feel the dignity of his position as the writer says the conductor ought to do, it seems to us that it would be quite as reasonable to expect a caravan of camels to go through the needle's eye. The idea of a man standing on his dignity who is handicapped with a bell-punch or a fare dial clock to make him honest, his every movement meanwhile watched by spotters, is a ludicrous travesty of the moral fitness of things. This is the process of reasoning by which we account for the congenial relations existing between the conductors and drivers of street cars."

The question opened up by this brief paragraph is a wide one, involving the whole subject of modern society, and the laws of modern commerce. It is a subject with which we propose to deal more at length, in the near future, but at present we will content ourselves with a few reflections and questions.

First, does the fact of being "in the same canoe" naturally make a man of honest purpose sympathize with the dishonesty of his associates? Does being in the same canoe with a cruel man incline a humane man to endorse cruelty? Our esteemed contemporary seems to think it does; but if so, there is something both wrong and unnatural in it.

Second, is "dignity of position" dependent upon the situation or upon the man who occupies it? We believe that there is such a thing as magnifying one's office, and that a dignified mind lends dignity to any position, and that there is nothing base, except a base mind.

Third, does the *National Car and Locomotive Builder*, when buying its paper, consider the price or, does it think only of the needs of the maker and seller of the same? If it buys in the cheapest market, irrespective of the needs of the laborer, how does it presume to condemn the railroad companies for buying labor on the same terms?

The question, as we have said, is broader than all this, and the street-car companies, who are mere victims of a vicious social order, are less to blame in conducting their business upon the recognized rules of that order, than are the employés who combine to condone offenses and protect offenders from the consequences of acts, which the universal moral sentiment condemns.

As for the handicap of the bell-punch or the fare register, does our esteemed critic suppose that these were invented merely to add an ornament to the car, or a decoration to the conductor? Does it not *know* that even with these safe-guards the peculations of dishonest employés are very great, and that without them they would be simply frightful? The bell-punch brands no man except the thief, any more than the precautions and safe-guards adopted in the mints and treasuries of the United States.

This talk about the disgrace of the bell-punch is all prompted by false sentiment or by dishonesty of purpose, and it should be no more expected that street-car conductors should be permitted to handle the companies' money without surveillance than that every employé in a bank should have keys to the vaults and safes. As well might one object to giving receipts for money collected.

Finally, does our contemporary suppose that there are no conductors who do feel the "dignity of their position"? If it does, it is mightily mistaken, and it is also mistaken if it imagines there are no conductors who agree with the views expressed in our editorial on Unions. We reaffirm here those views,—that the union of drivers and conductors is anomalous and that the practical workings of the combination will prove itself abortive.

THE PRESIDENT'S REVERIE.

* * * The committee presented its ultimatum and withdrew. The President, tired and worn with sleepless nights and the mental strain consequent upon being hounded by ill-advised and excited men, who, in a sort of "spring madness," had in a moment come to think their old-time friends and employers, by some hideous transformation suddenly become their enemies. That venerable man with snow white hair and a tired expression in his kindly blue eyes, did not appear the ogre he was represented—the buyer of flesh and blood, the oppressor of God's poor—rather, there alone in his little office, communing with himself, he seemed a man over whose knees little children would

fearlessly climb, and to whom helpless women would not hesitate to appeal with their cares and sorrows. Hear him, as he softly soliloquizes: "For fifty years I have been an employer of my fellow-men, and I have always endeavored to consider how much we could afford to pay, rather than how cheaply I could hire men. I have been glad to know that our employés were comfortably fed, clothed and housed; that their children were at school and their families contented and happy. I remember, when times were hard and we had to figure very close, we resorted to every known method of retrenchment, rather than reduce wages. I have never pitted labor against labor and hired those who offered to work for the least money, but I have fixed the wages at what I thought we could afford to pay, and selected the men at those figures, and, in placing the wages, I have tried to take into consideration the fact that I was employing my fellow citizens, brother men and human souls.

"Somewhere, lately, I have seen an article on 'Supply and Demand,' in which an evidently amateur political economist undertakes to apply this theory to the question of labor, and seems to think it is an unanswerable argument, a sort of rock of refuge upon which capital can securely anchor its argosies and defy everything from a blizzard to a cyclone. Pshaw! 'Fools rush in where angels fear to tread.' If this were so, there would be no labor troubles, for then employés could be bought and sold like fat cattle, or, if the application comes nearer home, like hay or horses; but, unfortunately for the supply and demand argument, in civilized countries men have rights and duties to themselves and each other, which can not and will not be ignored. I can buy a mule or a hog without consulting the animal purchased; but in this latter end of the nineteenth century, when we buy labor there must be a mutual understanding or bargain between employer and employé; of neither must be demanded what can not physically be performed, nor what is morally wrong or contrary to the welfare of that only legitimate-by-divine-right king—We, the People, or in legal terms, The State. The stream can not rise above its fountain head. Labor is the source of all capital, and without labor, accumulated wealth would be so much useless dross. The land-owner could utilize only such land as he himself could till, and the street railway president could build just so much road as he himself could grade with his own hands and equip with appliances of his own make. Further, all men, in a community, from millionaires to laborers, are dependent on each other, and this dependence begins at birth and ends when the body has been placed under the ground. We could live without hay or horses or even street-railways; we could not even begin to exist without the assistance of our fellow men. This mutual dependence carries with it mutual responsibilities, and as we advance in the scale of civilization, the dependency, and hence the responsibility, increases. Again, there is a higher law than the physical or written one. We call patriotism, love of country, a law so mighty that a man will even give his life at its command; and just in proportion as a citizen has prospered under his country's institutions and laws, in like proportion do his obligations to this higher law increase. As the heaven is, so is the mass; and a country is just as great, prosperous, enlightened and free as its citizens—no more, no less. If we keep men poor and ignorant, they breed paupers and criminals. What, then, becomes of our free and enlightened country?

" 'Ill fares that land, to hastening ills a prey,
Where wealth accumulates and men decay.'

"It is a duty we owe to the country whose institutions have made us what we are, to see to it that the present generation have enough of this world's goods to enable them to live as becomes American citizens, and to be able to so educate and rear their children that, when we are gone, free men and virtuous women, a nation's only true bulwarks, may assume the mantles and responsibilities which our fathers bequeathed to us.

"What, then, becomes of this 'horse and hay' theory—this law of supply and demand? Such narrow views and

partisan reasoning will not help me to grapple with the present trouble. I should be false to my training, false to my life-long practice, false to my country and false to myself, did I allow such nonsensical and mischievous vapors to influence me in the least. We are willing to pay all we can afford; glad, *very* glad, if it is much; sorry if, perforce, it must be little.

"We are dealing with our fellow men, not buying hay by the car-load, or horses by the dozen. Supply and demand! Nonsense! Were I an employé, and my employer should put me on a level with brutes and merchandise, I would strike too! I wonder if our men could have seen that article? I must talk to them in the morning, and let them know that here, at least, they are not classed with hay and horses."

THE NEW YORK CAR HORSE.

The New York *Times* discourses as follows: "The average serviceable life of a horse in street railroad work in New York is only from three to three and a half years, and the Third Avenue Railroad Company uses up about 600 horses a year. A knowledge of that fact might well alarm and depress any reflective horse. And yet the work laid out for the horses does not seem so severe. Sixteen miles a day on the Third Avenue line, which is, by reason of its grades, the hardest, or twenty miles on its branches, are deemed a sufficient day's work for a horse. And then an effort is made to give each horse one day of rest in seven, or, failing that, to make up its equivalent to him by diminishing his hours of toil. But the fret, and worry, and strain of frequent stopping and starting the car, and the continual pounding of the feet on the hard, round cobble-stones, and the cruel sprains inflicted by slipping on the smooth rails, all these soon wear out the poor horse, break his heart, and make him a mere wreck, fit only to suffer a little longer between the shafts of a huckster's cart, or, by a happier fate, go to the knacker's yard at once."

HIS NAME DESERVES TO LIVE.

Now and then some thoughtful individual, in the midst of the selfish rush and hurry of modern life, performs an act of generosity which helps to redeem his race. Such golden deeds make us all, for the moment, share the nobility of the doer and help to make us better and gentler men. Of this sort was the kindly instinct which prompted Superintendent Martin, on one of the bitter cold days they had in New York during last winter, to furnish to the Brooklyn bridge gatemen a lot of car tickets to be given to such pedestrians as appeared too thinly clad to resist the bitter breezes of the foot-walk. It was a little thing, but one of the sort which proves that goodness has not yet died out of the earth.

RASPING HOOF.

"An Experienced Blacksmith," quoted by an exchange evidently agrees with the Rev. Mr. Wood's opinions about rasping horses' hoofs, as he says: "More horses' feet are ruined by rasping the hoof than by any other cause. The outside coating is impervious to water and does not evaporate. When broken into by rasping the moisture of the foot evaporates, leaving the hoofs dry and brittle."

A NEW ELECTRICAL RAILWAY.

A dispatch, dated the 15th inst. announces the successful opening of the electrical street railway in Montgomery, Ala., on the Van Depoele system.

PROTECTION AGAINST STRIKES.

The following is the form of an agreement between the New York Street Railway companies, looking to mutual protection, in the event of future strikes or "tie-ups":

Agreement made and entered into this—day of —, 1886, by and between —, undersigned corporations operating street surface railroads in the State of New York, and such other like corporations as shall by consent of the Executive Committee hereinafter mentioned be permitted to subscribe thereto,

Whereas, The employés of street railroad corporations have repeatedly threatened strikes if their demands against the corporations were

not complied with, and have by threats of "tying up," or suspending the business of said corporations, compelled them to yield to unjust exactions;

Now, in order to guard against the success of such threats and intimidation in the future, and to prevent the loss which any of the undersigned would sustain should its business be suspended by reason of refusal to submit to improper demands of its employés, and in consideration of the mutual assistance which is hereby guaranteed and for other valuable considerations, the said corporations have hereby declared, covenanted and agreed, and do hereby declare, covenant and agree as follows:

First—It is declared that twelve hours' labor, including a fair time for dinner, shall constitute a day's work for the conductors and drivers of street surface railroad companies, and that the same shall be paid for at the rate of \$2 per day, and that any employment over or under such time shall be paid for at the same rate; but this declaration shall not prevent any of the undersigned from permitting conductors or drivers to work a less period, or to receive payment at a higher rate than \$2 per day.

Second—As soon as this agreement shall be subscribed by at least—companies, each of said companies shall designate a representative who shall meet at such time and place as shall be designated by the president and Executive Committee of the Street Surface Railway Association of the State of New York and the said representatives shall from among their number elect an Executive Committee of five, which committee shall have the power to determine the amount to be paid to and by each company from time to time under the terms of this agreement, and which committee shall act as an advisory committee in all questions pertaining to the cause, duration and cessation of all suspensions or tie-ups. The said committee shall continue in office as such until such time as at the request of a majority of the subscribers hereto, a meeting for the election of their successors shall be called and successors be elected pursuant to such call.

Third—If a tie-up or general suspension of the business of any of the undersigned shall take place by reason of the refusal of any of the undersigned to accede to any demands of any of its employés the loss incurred or sustained by such company during the period of such general suspension shall be made good in the manner hereinafter provided. Provided, however, that such general suspension or tie-up shall not be caused by the refusal of such company to pay the rate of compensation to conductors and drivers as heretofore mentioned, or by the exaction of longer hours for a day's work than that heretofore mentioned.

Fourth—The daily loss which any company shall be deemed to have sustained during the period of the general suspension of its business shall be the general average amount of such company during the corresponding month of the preceding year, deducting therefrom the amount saved in the expense of operation and maintenance by reason of such suspension. The amount of such average daily loss shall be determined upon this basis by the Executive Committee as soon after a tie-up or suspension has taken place as possible.

Fifth—To reimburse such suspended company for such loss, the Executive Committee shall from time to time and not less than once in each week during the period of such suspension, collect from the subscribers hereto, including the suspended company itself, the amount of such loss and pay the same over to the suspended company, each of the said companies including the suspended company, to be assessed by the committee and to pay toward the amounts required for retirement of losses in proportion to the respective net earnings of each company during the preceding year.

Sixth—The determination of the Executive Committee as to the amount to be paid to or by any subscribers hereto from time to time, shall be final and binding upon all the parties hereto, and in the event of non-payment on demand by the Executive Committee by any company of the amount assessed against it, the amount shall be deemed legally recoverable by the suspended company from such defaulting company and by vote of the majority of the Executive Committee such defaulting company shall be thereafter considered debarred and excluded from the subscribers hereto, without in any respect modifying, altering or varying this agreement as to the other subscribers.

Seventh—This agreement shall continue in force and effect until such time as it may be declared terminated by an agreement in writing, to be subscribed by a majority of the subscribers hereto, and after written notice of such agreement to terminate shall have been given to all the subscribers. But in the event of said termination each company shall be liable for all amounts which it may have incurred under the terms of this agreement up to the time of the service of such notice.

Eighth—Whenever a majority of the Executive Committee shall so determine and whenever such determination shall be ratified in meeting by two-thirds of the subscribers hereto, any company or companies then under suspension or tie-up shall, by yielding to the demands of its employés or otherwise, cause such suspension or tie-up to cease, and if within three days after the service of notice of such determination upon the suspended company it shall not have taken steps to end such tie-up or suspension, all further payment under this agreement may, at the option of the Executive Committee, cease and terminate.

Ninth—The term "net earnings" used in this agreement shall be construed to mean the overplus remaining after deducting from the gross receipts of the company from passengers all expenses attendant upon its operation and maintenance exclusive of fixed charges and taxes.

In witness whereof the subscribing companies have hereto respectively affixed the seals of their respective corporations and caused these presents to be signed by their respective presidents, the day and year first above mentioned.

SALE OF THE NORTH CHICAGO CITY RAILWAY.

On March 24th a controlling interest in the above railway company passed into the hands of C. T. Yerkes and associates. C. T. Yerkes was elected president, to succeed V. C. Turner.

The capital stock of the North Chicago City Railway consists of 5,000 shares of \$100 each. The purchasers are said to have paid \$600 per share for 2,550 shares, or \$1,530,000 cash. A sale of some stock in the above corporation took place a few months since, as reported in the daily papers, at \$625 per share. This is believed to be the highest cash price ever paid for street railway stock. The road is considered to be one of the best managed in this country. Rolling stock, stables, horses, tracks, are unexcelled.

The retiring president and superintendent, V. C. Turner, was born in Malta, Saratoga County, New York, February 25th, 1823. He received a good primary education, and was employed by his father, the late John B. Turner, who was a contractor upon the Erie Railway, Genesee Valley Canal, etc.

He prepared for college, and graduated at Williams College in 1846. In the fall of that year he removed to Chicago, and soon afterwards began the practice of law, which he followed twelve years.

February 14th, 1859, the Illinois legislature incorporated the North Chicago City Railway, V. C. Turner and his father, John B. Turner being among the original incorporators.

Mr. John B. Turner was the president, and Mr. V. C. Turner the secretary and treasurer, until July, 1865, when he was elected vice-president, which office he held until January, 1877. At the last named date he was elected president, and has been annually re-elected to date.

By the great fire of 1871, the company lost \$350,000, their stables, horses and rolling stock having been consumed. The horses were turned loose, but were ultimately recovered. The intense heat burned and twisted the rails, and destroyed miles of track.

Mr. Turner set energetically to work and reconstructed the road, buildings, etc., and gradually brought the road up to its present condition by his able, shrewd and conservative management. He is a man of unimpeachable integrity, whose simple word is equal to the bond of many another man. He is warm hearted, but undemonstrative, so that the general public considers him hard, which is, in fact, quite the reverse of the opinion formed of him by those admitted to his friendship.

His unremitting cares and anxieties incurred in managing this great corporation undermined his health. Having an ample fortune, he decided, after mature deliberation, to sell his stock and take a much needed rest, with the hope of thereby recovering his health. His life has been such that all might profit by following in his footsteps.

In his retirement from active management of street railways, he carries with him the kindest wishes of THE STREET RAILWAY GAZETTE, as well as that of each and every employé of the North Chicago City Railway.

Mr. C. T. Yerkes has had considerable experience in street railway management. He is a man of more than ordinary ability, possessed of agreeable and courteous manners, and under his conservative and shrewd business management, the stockholders in the North Chicago City Railway may anticipate no diminution in dividends.

As announced in another column, Mr. Augustine W. Wright has tendered his resignation as Superintendent of Track and Construction and Chief Engineer of the North Chicago City Railway, to open an office as Consulting Engineer. He will also be President and Chief Engineer of the Wright Construction Company. This corporation is formed for the purpose of constructing street railroad tracks, new and old. Mr. Wright is so well known to our subscribers that he needs no introduction to them. He has entered upon his twentieth year of engineering service, and is capable of doing the best work

and will accept no contract where he can not do full justice to his reputation in this respect.

He will henceforth take an active part in the editorial department of THE STREET RAILWAY GAZETTE.

PERSONAL.

CALVIN A. RICHARDS.

President Richards has covered himself all over with glory by his graceful concession to the employés of the Metropolitan road, after listening to the persuasive arguments of the representatives of the Knights of Labor. We have had many times to call attention to what we deemed the shortcomings of this energetic gentleman, but the promptness with which he has met the reasonable demands of the men under his control, and thus avoided inconveniencing the public, is deserving of all praise. Henceforward we will not grumble when we have to sit eleven on a side.—*Manufacturers' Gazette.*

JACOB SHARP.

It is said on what seems to be good authority that Jacob Sharp will shortly sell his interests in the different lines with which he is connected, and retire to private life. Mr. Sharp originally came from Rome, N. Y., and settled in New York about 1850, since which time he has been an active and successful street railway manager and financier. He has been instrumental in building and has helped to manage the Broadway Surface Railroad, the Broadway and Seventh Avenue Road, the four branches of the Dry Dock, East Broadway and Battery Place Road, the Twenty-third Street Railroad and its Thirty-fourth street branch, the Forty-second and Grand Street, otherwise known as the "Green Line," the Christopher and Tenth Street Road, the Christopher, Fourteenth Street and Union Square Line, and the two branches of the Bleecker Street Road, one running to the Brooklyn Bridge and the other to Fulton Ferry.

FRED L. THREEDY.

Mr. Fred L. Threedy, who has served the North Chicago Railway Company faithfully for many years, and has worked his way up, step by step, from the ranks, as a conductor, has been appointed Superintendent of the entire road. Until recently he has held the position of Assistant Superintendent, but on the assumption of control by the new management, he received his promotion.

AUGUSTINE W. WRIGHT.

The widely known engineering specialist, Augustine W. Wright, who has been, for some years past, professionally in charge of the engineering department of the North Chicago Railway Company, has resigned from the service of that company, and will hereafter engage in active engineering work as President of the Wright Construction Company of Chicago. Mr. Wright, since the inception of the GAZETTE, has devoted to its columns all the time he could spare from his other duties, and will hereafter take a much more active part in its editorial conduct.

POINTERS.

DISTRICT OF COLUMBIA.

Washington.

Senator Van Wyck (Neb.) made, the other day, a savage attack on the street railways of the city, accusing them of "evading the law," etc.

**

ILLINOIS.

Chicago.

It is stated that the Chicago Passenger Railway Co. has secured the necessary signatures to its petition to lay tracks on Adams street, from Clark street to the lake. An ordinance granting authority to lay these tracks without a petition was passed months ago, but an injunction intervening necessitated further legislation.

In an extensive article, which bears the marks of inspiration, a local paper suggests that the new management of the North Side road will probably introduce cables on three of its longer lines.

On the 24th ult. the Union Elevated Railway Company was incorporated at Springfield, with a capital stock of \$10,000,000. The incorporators are County Clerk Michael W. Ryan, United States Commissioner P. A. Hoyne, Assistant District-Attorney Chester A. Dawes, Edgar T. Paul, and Edward E. Swiney. They say there are no definite plans as yet, beyond the attempt to establish the system of rapid transit wherever the right of way is available. A score of patents which they have secured, will give them special advantages when once started.

Among other changes introduced by DeWitt C. Cregier, the West Side Company's new superintendent, is a reduction of the night-line conductors' pay, from \$2.30 to \$2.00 per night, for five trips after midnight. The "calling" time for which pay has been allowed since the strike last June, has also been reduced from 18 minutes to 10 minutes.

Sometime since the mayor vetoed and returned to the city council an ordinance granting the North and West Side street railway companies a right of way on Halsted street, between Indiana street and Clybourn avenue. The two lines are to connect at the river. The mayor's veto was based on the fact that the ordinance contained no provision requiring the companies to build a new bridge when it should be deemed necessary. In reconsidering the ordinance, it was shown that it provides for a continuous line from the far North Side to the Stock Yards on the extreme south, and that the companies claim that this short connecting link would not pay, and the companies would not accept the franchise if it required them to build a bridge. On the other hand, were the original ordinance passed, the road would be built this year. The people along the route are eager for the road, and the two companies have entered into an arrangement for the issue of transfer tickets, so that such tickets issued by the south branch will be accepted on the West Side company's lines. Upon these explanations being made, the ordinance was passed over the mayor's veto, and the road will be built.

A petition has been presented to the City Council asking permission to construct and operate an underground railway in certain sections of the West and North Divisions of the city. If the desired permission is granted the Arcade Rapid Transit Company, the title of incorporation, proposes to construct a double track railway, first under Monroe street, running west, and from the Monroe street line one running north and then northwest to city limits. The company agrees to complete the work in reasonable time, and to operate the railway by cable, electricity, or such other approved power as will insure the greatest comfort, safety and speed.

In section, the scheme shows two tunnels, side by side. Going out, the cars will pass through one compartment, and return by the other, the brick partition wall shutting out all disagreeable noise from passing trains and avoiding all possibility of collision. In constructing the arcade it is proposed to dig a trench through the middle of the street and down to several inches below datum. Two perpendicular brick walls, seven feet six inches high, three feet thick at the base and twenty inches at the top, and twenty-four feet apart, will then be run parallel the entire length of the street, or as far as the line extends. Midway between these exterior walls will be a brick partition, or dividing wall, sixteen inches thick, separating the arcade into two compartments, each eleven feet four inches wide. The floors of the arcade have the form of an inverted double arch, while the roof is a level plain. The top of the roof is sunk twenty inches below the surface grade of the street. The rails over which the trains are to pass are twelve feet and six inches below the surface of the street, and sufficient space is left between the rails and floor of the arcade to run cables, if used in operating the cars, and the water, sewer, and gas pipes of the city, the company having promised to provide for all mains on the line of its road. The dimensions of the tunnel or arcade are ample to accommodate cars seven feet high and seven feet six inches wide, and still leave sufficient space for free ventilation. To cross the river, beginning

on the west side of the river, at a point about midway between Canal and Jefferson streets, the arcade merges into a double tunnel, each compartment circular in form, twelve feet wide and thirteen feet six inches high, twenty four inch walls, and partitioned by a twenty-one inch brick wall. This tunnel has a gradual decline toward the middle of the river. The bottom of the tunnel, when it reaches the center of the river, is thirty-four feet below datum. Along the line, at convenient distances for the public, will be stations for entering or leaving the trains.—*Amer. Engineer.*

During the past unusually severe winter, the South Side company has once more demonstrated the entire suitability of its cable system to the climate and conditions. We have heard of no stoppages whatever, on any account, and surely if snow and cold could have any effect, it would have been demonstrated during January and February. The new machinery gives great satisfaction.

The West Division Co. has compromised, by the payment of \$150, a suit for \$1,000, instituted against it on behalf of Lizzie May Elson, a little girl who had her leg broken by a Madison-street car, which ran over her, April 10, 1885.

Moline.

We are in receipt of a personal letter from General Manager Hartzell, as follows: "The Union Street Railway Co. was incorporated last October. The proposed line will be operated between the cities of Moline and Rock Island, a distance of five and a half miles. It is a dummy road. The capital stock is \$21,000, divided into shares of \$100 each. The directors are J. W. Hartzell, Eugene Lewis, Geo. H. French, Geo. W. French, Mr. Decker and Mr. Adams. We have begun active work on the road, and expect to have the entire line in operation by July 1, 1886." Geo. Watson French is secretary and treasurer, and J. W. Hartzell general manager of the company.

Rock Island.

The Davenport & Rock Island Street Railway Co. has been incorporated to construct, maintain and operate a street railway in the city of Rock Island. The capital stock is \$30,000, and the incorporators are Morris Rosenfield, Henry C. Connell and Henry Curtis.

Streator.

Henry A. Foster, Daniel Heenan, Hiram J. Wood, Oscar B. Ryan and Ruland Alden have incorporated the Streator Surface Railway Co., to build and operate a road in the City of Streator. The capital stock is \$50,000.

IOWA.

Keokuk.

The Keokuk Street Railway Co. had a strike on its hands during the closing days of March, the grievance being "failure to receive prompt pay." The cars were not interrupted.

Oskaloosa.

The citizens having failed to raise the required \$2,000 bonus, to build the projected street railway, the enterprise has been abandoned.

MARYLAND.

Baltimore.

A bill making it compulsory on the street railway companies in this city to reduce the working time of their conductors and drivers to twelve hours per day, was passed unanimously by the house, in the legislature at Annapolis, on the 25th ult.

The results of the strike point a fresh moral to the fable of the dog and the shadow. The employees, being dissatisfied with their hours and wages, demanded \$200 for 12 hours work, but President Bowie refused it, and offered \$2.50 for 16 hours. The men thereupon joined the Knights of Labor, preparatory to fighting it out. Meanwhile, the legislature passed the "12 hour bill," and the company reduced the pay to \$1.50 per day. The men now regret their refusal of the president's first offer, and are sorry they meddled with an organization which bound them to stand out for 12 hours. The 12-hour system requires double sets of men, and not a

company in Baltimore could afford to pay \$2.00 for 12 hours.

MASSACHUSETTS.

Boston.

Presidents Merrill, Richards and Powers disclaim any knowledge of negotiations looking to the control of any Boston roads passing into the hands of the Philadelphia syndicate, and doubt the possibility of such a consummation.

At a conference between the officials of the Metropolitan and Highland companies and the Knights of Labor, on the 25th ult., the following satisfactory adjustments were reached: On the Metropolitan road the pay of all regular conductors and drivers is increased from \$1.75 to \$2 a day; extra men to receive \$2 in place of \$1.50; hostlers to be paid \$0.25 a week instead of \$3; tow-boys \$9 a week; all employed receiving less than \$2 a day have their wages increased 15 per cent; snow-plow drivers and helpers are to receive 25 and 20 cents an hour respectively. Employés will be paid 4 per cent interest on all deposits held more than three months by the company. Hours of labor will be reduced in all cases to the lowest possible limit. On the Highland road, drivers and conductors have always received \$2 a day, and no increase was asked. Extra men are increased from \$1.75 to \$2; hostlers to receive \$10 a week; tow-boys \$3 a week instead of \$7; 10 hours to constitute a day's work. The time-tables are to be arranged so that 11 hours shall constitute a day's work for drivers and conductors; for over-trips, the men to be paid 25 cents each a trip. These agreements were endorsed with great enthusiasm at a mass-meeting of employés. The arrangement took effect on the 4th inst.

The Metropolitan street railway company's stable, a large 2½-story brick building on Pynchon street, near Tremont, was damaged \$3,000 by fire on the night of the 6th inst. It was insured. The loft and the roof and the upper portion of the building was destroyed, with a large quantity of hay and grain. There were nearly 300 horses in the stable, but all were saved.

The Highland Street Railway Co. has voluntarily raised the wages of its conductors and drivers to \$2.25 per day.

The railway running 2½ miles from the Boston & Maine dépôt, across into Stoneham Centre, is to be extended east through Melrose into Lynn. The railway's commissioners are discussing the location of the track.

Brocton.

A new street railway has been started in this town.

Holyoke.

The rails for the new extension are on hand, but as the timber is not yet ready, work will be delayed for a short time.

New Bedford.

The Acushnet Street Railway Co. is said to have placed orders for electric motors with which to equip a portion of its road.

Stoneham.

The directors of the Stoneham Street Railway have voted to increase the pay of drivers from \$1.50 per day to \$1.75, and the pay of conductors from \$1.75 per day to \$2. The men are satisfied.

MISSOURI.

Kansas City.

We have received the following authoritative statement, in a personal letter, dated Kansas City, April 7, 1886: "The Grand Avenue Railway Co., which last winter obtained franchises for a cable road, is about to commence construction. The line begins at the Chicago & Alton Railway dépôt, at the north end of Walnut street, and extends south on Walnut and Thirteenth streets and Grand avenue, about 4 miles to Westport, with a long branch from Grand avenue east on Fifteenth street, 2 miles to the new city limits. Total length of line, 6½ miles of double tracks. The estimated cost is \$1,500,000. The officers of the company are Wm. J. Smith, president; Walton H. Holmes, vice-president and general manager, and J. T.

Thornton, treasurer. The firm of Knight & Boneteco, of this city, are the engineers."

This town has no street railway, but the residents are anxiously looking for some one who will supply the deficiency. A correspondent writes us, in a personal letter: "We have no street railway yet, but are anxious that some party should come here and build one. The city will give a very liberal franchise."

"Our city is growing very rapidly; our population in 1880 was 2,500, and now it is between 7,000 and 8,000, and at the present rate of increase will reach 10,000 in twelve or eighteen months. We have gas works and water works, and are now anxious to secure a street railway."

"The principal street, running west from the dépôt through the best part of the city, is one and a half miles in length, and the grade is very easy—in fact, nearly level." It looks like a good chance for an investor.

St. Louis.

The wire cable for the St. Louis cable street railway was put in position during the first week of this month. Twenty-six horses did the pulling. The road is now reported in regular service.

An elevated electric railway bill, which left a loophole for the substitution of steam as a motive power, and which passed the city councils, has been vetoed by Mayor Francis, who says in his message: "An elevated railway, with electricity as the exclusive motor power, to be restricted to the carrying of passengers, would be a credit to the city, and undoubtedly a benefit to the people at large; but the rights of property damaged by its construction should be securely protected, and the bill should be so framed as to leave no question as to the exclusion of steam as a motor, or as to the possibility of its being converted into a freight road while in the hands of its projectors or their successors."

NEW JERSEY.

Jersey City.

President Thurston, of the Jersey City & Bergen Point railroad, in an interview says: "We are at work on a schedule to run our cars on five minutes time on the belt line during certain busy hours, and it will go into effect just as soon as we can get matters in shape. The men are satisfied with the justice of the officers, and are making no complaints, the bettering of their condition being voluntary. The company has in force a plan of graduated payment for conductors. The first three months a conductor receives \$1.75 a day; the next three, \$1.80; the next four, \$1.90, and the next four \$1.95. After eighteen months' faithful service he receives \$2 a day from that time on. This rule only applies to new conductors. If any of them are receiving \$1.90 a day, the rule does not affect them." Mr. Thurston further says: "This plan will make it to their own interest to remain with us and serve us faithfully. We want to make it an object for our men to stay with us. We make promotions from the ranks, and I insist upon all our office help being residents of New Jersey. None of our drivers receive less than \$2 a day. In making an investigation of the hours of labor and pay of our men, I found that eleven of our drivers were getting \$2.25 a day, while the remainder were getting \$2 a day, or the same as the New York drivers are now receiving. I asked why some drivers received \$2 and others \$2.25 a day. I found that those who got \$2 a day on the belt line make eight round trips, while those who received \$2.25 make nine round trips. It takes thirty minutes to make the down trip on the belt line, and thirty-four minutes the up trip, so that the \$2 drivers, who make eight round trips, put in eight hours and thirty-two minutes actual labor, and the \$2.25 drivers, who make the nine round trips, put in nine hours and thirty-six minutes actual labor, with 'swings' in the middle of the day."

Orange.

On the twenty-fourth ult., the striking fever attacked the "tow-boys" on the South Orange line, and they struck for an advance of \$1.00 per week. The demand was refused, and the cars ran without horses until other boys could be hired.

NEW YORK.

Brooklyn.

The Atlantic Avenue Railroad Company proposes to build and operate a street railroad from Red Hook Point to Atlantic avenue. The route will be from Greenwood Cemetery, along Ninth avenue to Fifteenth street, to Hamilton avenue, to Hicks street, to Atlantic avenue, to South ferry and through Furman street to Fulton ferry. The franchise is now held in the name of the Prospect park and Coney Island Railroad Company, but the franchise was given to Mr. Richardson when he leased all the roads belonging to the aforesaid railroad company.

The Atlantic Avenue Railroad Company, the lessee of the Prospect Park and Coney Island Railroad, intends to substitute cable traction cars for horse cars on the following streets:—

Park avenue to Broadway, to Navy, to Concord, to Washington, to Water, to Fulton, to Front, and from Fulton to Washington, returning by the same route. Beyond Broadway the road extends through Jefferson street to Central avenue and other streets, to Evergreens Cemetery and the city line.

Mr. Richardson says in relation to his proposed cable road from Fulton Ferry to the Eastern District, that no time will be lost in pushing it to a speedy completion. It has been decided to adopt the Johnson cable, now in operation in Harlem, and if the consents of the people along the route are obtained without delay, the road will be in operation by October 15.

A second tie-up was threatened on the Atlantic Ave. lines this month, but on the 7th the differences were amicably adjusted, as follows:

"Trippers to have work enough to make \$1.50 a day. Extra drivers and conductors, who are unemployed, may volunteer to make extra trips in addition to the tables now in force, at such prices per trip as shall be offered by the company, which shall not be lower than the regular trip rate. But no man who fails to decline to so offer his services shall suffer the consequences thereof.

"Stablenmen hereafter to receive \$12.25; tow-boys, \$1 per day.

"So far as the mechanics are concerned the question shall remain open, so that the men can present their own demands and Mr. Richardson can come to an agreement with them. The pay of pavers to be \$2.15, and of rammers, \$1.90, while laborers will receive \$1.60, and night watchmen \$13 per week. Drivers of snow-plows will receive double pay. Blue uniforms are to be substituted as soon as the present contract expires."

The section demanding that all discharges shall be investigated by the Knights of Labor was stricken out, but Mr. Richardson agreed to furnish each man discharged with written reasons for the act; employes accused of misconduct shall have a hearing in the presence of their accusers. The question of emergency trip was settled upon the basis that such trips be paid at the rate of time occupied in making a trip.

All differences between the 1,800 employes and the officers of the Brooklyn City Railroad Company have been settled.

On the 27th, about 250 employes of the Broadway Railroad Company struck. They were employed on the Broadway and East New York, Sumner Avenue, Reid Avenue and Ralph Avenue lines, all centering at the foot of Broadway, whence the Grand Street, Roosevelt Street and Twenty-third Street ferries run to this city. Demands had been presented on the 25th, as follows: Twelve hours a day, at \$2, seven trips on the Broadway line and eight on each of the others to constitute a day's work; "trippers" to receive \$1.50 a day; all supplies to be furnished by the company; half an hour to be allowed for dinner; the hostlers, changers, hitchers, feeders and car-cleaners to work twelve hours a day, with an hour for breakfast and an hour for dinner, and tow-boys to work only ten hours.

To this Mr. Beers sent the following reply: "Your communication of this day has surprised us, because we have assurance on all sides that our present regulations as to labor and wages give universal satisfaction to our employes. In fact, a testimonial to that effect has been voluntarily

presented to this company. In reply I have to state that our executive committee came to the conclusion that in order to decide on so important a matter they thought it proper to know whether the same demand has been made on all the horse railroad companies in Brooklyn, and if so they would like to act in unison with them, and will, therefore, have to postpone answering definitely."

The strike was then ordered, and continued until the 23th, when, the company having made the desired concessions, the strike was raised.

New York.

The three bills—one annulling the charter of the Broadway Surface Railroad; one requiring the consent of those owning abutting property before a street railroad can be laid in any street; and the third, for winding up the Broadway road and other corporations whose charters may be revoked, have been passed, by almost unanimous vote, in the State Senate.

On the 7th inst. the Railroad Committee of the State Senate voted to report favorably a bill authorizing any of the city surface railroads to substitute cable traction for horse power, with the consent of a majority in value of the abutting property owners along the route.

At the Grand Street Station of the Metropolitan Elevated Railroad, Joseph Oppen, in January 1880 sought to pass the gateman on depositing a ticket which he had purchased the day before. When he insisted on forcing his way in, he was handed over to a policeman, who, after detaining him for awhile, released him. He sued the company for \$5,000 damages, and after trial before Justice Peckham and a jury in the Supreme Court, on the 25th ult., obtained a verdict for 6 cents.

In 1884 there were 234,115,862 passengers carried by the railroads in New York City, and the statistics show a growth of 20,000,000 annually, equal to 420,000,000 passengers in 1890, and to 835,000,000 in 1900.

The increase in the number of passengers carried on the bridge cars, proves the wisdom of the reduction of fares a year since. The cut in railway fares was about 50 per cent., and it caused the railway to be used by more than twice as many persons as before. The number of passengers increased 10,922,180 in the twelve months ending March 1 over the twelve months preceding—from 9,234,600 to 20,156,870—and the increase in receipts was \$92,387.15. Naturally the cheaper car-fares caused a falling-off in travel on the promenade; the decrease in the receipts for the year following the reduction was \$18,113.47. The largest number of passengers carried in the cars in any one month was 1,958,495 in October last—an average of over 63,000 daily. The railroad is now used to the utmost extent of its capacity, and no relief can be obtained until the extension is built.

A new elevated road is proposed for Broadway, the principal route being defined in the petition thus:

"Connected with the main or stem line, which commences at Broadway opposite Bowling Green, thence through private property to Church street, at the intersection of Chambers and Church street, and runs thence easterly along Chambers street to the intersection with Broadway, with a sufficient curve at the angle of said streets; thence northerly along Broadway to Forty-third street; thence, with a sufficient curved line at the angles of said streets, easterly along Forty-third street to the Grand Central Depot, with curved lines at the angles of Forty-third street and Fourth avenue to permit of said branch extending along the westerly frontage of said depot between its southerly and northerly angles; such route being deemed by said Board to be the most practical and best calculated to promote the public interests in connection therewith."

This is an old scheme revived, the original project having been advanced in 1882 by the Metropolitan Transit Company.

A bill known as the "Cantor bill" has been passed by the Assembly. Its provisions are as follows:

The local authorities of any incorporated city or village

to whom application under the provisions of this act may be made for consent to the construction, maintenance, use, operation or extension of a street surface railroad upon any street, road, avenue or highway, must provide as a condition of the said consent to the use of said street, road, avenue or highway, that the right, franchise and privilege of using the said street, avenue or highway shall be sold at public auction to the bidder who will give "the largest percentage per annum of the gross receipts" of said company or corporation with adequate security to the corporation of said city or the trustees of said village for the right, franchise and privilege of using the said street, avenue or highway, subject to all the provisions of this act to so construct, maintain, use, operate or extend such street surface railway. Prior to such sale, notice of the time, place and terms thereof and of the route to be sold, and of the conditions upon which the consent of said local authorities to construction, maintenance, use or operation of such street surface railroad thereon will be given, shall be published three times a week for at least three weeks in two daily newspapers of said city, to be designated by the Mayor of said city. And the local authorities of any incorporated village shall, prior to any sale by them as herein provided, cause the notice above provided for to be published three times a week for at least three weeks in a newspaper to be published in said village, if any there shall be; if none, then in two daily newspapers published in the city nearest said village.

This bill is an amendment to the general Street railway act of 1884, and if it becomes a law will probably cause a good many new roads to go into bankruptcy within a very few years from their birth.

It is said that after breaking some \$70,000 worth of lamps, the managers of the New York elevated road are about to fit out their cars with electric lights.

It is said that hereafter the worn-out car horses of this city are to be fed to the carnivorous animals in the zoölogical gardens.

**

OHIO.

Cincinnati.

The Mt. Adams and Eden Park Railway recently closed its inclined plane four days, during the progress of repairs.

Cleveland.

Extensions and improvements are contemplated by the East Cleveland Ry. Co.

On the evening of the 27th ult., the Board of Aldermen passed, under suspension of rules, an ordinance reducing the hours of labor on the street railways to twelve, including the time for layovers and meals. The Brooklyn company has already obeyed these provisions, but the other companies refuse to do so. The wages on all the lines have been made uniform at \$1.75 per day.

Columbus.

The board of four arbitrators to whom was submitted the difficulty between the street-railway company and its employes, on the 27th ult. rendered the following report:

We have examined the president and secretary of the railroad company and a delegation of the employes at length, and have heard statements from these officers and men. We have carefully examined the books and accounts of the company, with a purpose of ascertaining accurately its receipts and disbursements, and the manner in which the business is carried on. We find that there are no large salaries paid to officers or others, and no extravagance in the management of the company. On the contrary, it appears to us that rigid economy is practiced in the management of its affairs; that the men, many of whom have been in the employ of the company for a number of years, have rendered excellent service to their employers. We further find that the employes of said company shall receive compensation for their services per annum from and after this date as follows, to-wit: Earn men, 1.35 per day; drivers of conductor cars, \$1.50 per day; conductors, \$1.70 per day; pay-box drivers, \$1.70 per day; tunnel men, \$1.70 per day.

This report was signed by all save one of the arbitrators, who thought the wages should be higher. The schedule adopted by the arbitrators makes an increase of 20 cents a day to drivers and conductors, and 15 cents a day to stablemen. Under the new schedule, conductors and drivers on conductor cars can make \$12.50 per week by working full time, drivers on pay-box cars \$11.10, and stable men \$9.45. Under the agreement by which the matter was submitted to arbitrators, they were unable to consider the question of hours of labor, though one of the board thinks it should be made twelve hours. The board found that the company is not earning large dividends, and it has an indebtedness of \$190,000, nearly all bonded. They also found that passengers are carried cheaper in Columbus than in other cities, with one possible exception.

Dayton.

In the recent troubles, there was considerable disturbance, and cars were damaged respectively. A compromise was finally effected, the men receiving \$2.00 for 16 hours work.

* * *

PENNSYLVANIA.**Philadelphia.**

The street railway employes of the city have organized a benefit club, each member paying \$1 entrance fee and ten cents a week dues. This gives a sick benefit of \$5 a week for a year, \$50 for a member's death and \$25 on the death of a member's wife.

The Arbitration Committee of the Quaker City Protective Association, on the 23d ult., presented a bill of grievances to the railway presidents, giving them until the 1st inst. to answer. At a conference on that date, an amicable understanding was reached, by the terms of which employes receive \$2.00 for twelve hours' work.

Pittsburgh.

An interesting suit has been decided by a Pittsburgh jury against the Pittsburgh, Allegheny & Manchester Passenger Railway Co., of that city. The case may be outlined as follows: A discharged conductor was detected riding in the company's cars on employe's ticket. To prevent a continuance of this abuse an assistant superintendent posted a notice to this effect: "A B. (naming the conductor) has been discharged from the service of the company for not ringing up all fares collected. Discharged conductors are not allowed to ride on employe's tickets." This notice was intended for the information of the company's conductors, but was not addressed specially to any one, and was posted in the harness repair shop, a private place, but just at that time open to employes, because the regular waiting rooms were undergoing repairs. The notice was posted one day and taken down the next, although some testimony was introduced showing it was up longer. The posting of this notice constituted the alleged libel. The defense was: First, the notice was a privileged communication; second, the words "not ringing up all fares collected" do not necessarily imply dishonesty—a conductor might fail to ring up all fares collected from want of natural aptitude for his business, from carelessness, or from dishonesty. The court was asked for a compulsory non-suit on questions of law, which was refused, and the jury returned a verdict of \$400 for the plaintiff. This is but another of the common cases of the "jury of twelve intelligent citizens" against the corporation. It is no use for a corporation to expect any sort of equity from a jury; to the higher courts that are above local prejudices and care more for abstract justice than for the sentimental side of the "rich-man, poor-man, beggar-man, thief" twaddle of the common jury room, to these alone can a corporation look for fairness or equity in its legal difficulties. We trust that the case will be appealed.

This city has had its turn—and a rather protracted one—with street railway strikes. The story of this strike is as follows: About one month ago, the employes made a series of demands on the companies, which, being deemed reasonable, were granted, with the exception of one concerning the reinstatement of a few men that had been discharged for cause. In refusing to grant this demand, however, our correspondent states that the companies offered to leave it to arbitration. The men refused to do so. The agitation continued for some time, and, on the 27th ult., no adjustment having been reached, a general strike was ordered by the executive committee K. of L., on the following lines: Wylie avenue, Pleasant Valley, Birmingham long and short lines, Union, Pittsburgh, Manchester, and Allegheny, Rebecca street, Troy Hill, and Oakland Roads. They employ about 1,200 men. The Transverse, Citizens' and Second avenue lines, having conceded all points, were not included. During the 27th, no attempt was made to run the cars, and the 28th being Sunday, affairs still remained in *status quo*. Matters remained in about the same position, without attempts at forcing the fight on either side, until the 4th inst., when propositions were exchanged

between the parties, and the following terms finally agreed upon and signed:

First—That 13 hours shall constitute a day's labor, the time to be reckoned from the hour of starting to the hour of quitting.

Second—That one hour of the 13 shall be allowed for meals; the time for meals to be arranged between the employers and employes of each line.

Third—If a driver or conductor shall be compelled to lay off a day to clean his car, he shall be paid for it as if he were engaged at his regular occupation.

Fourth—The pay on all cars on which one man is employed, shall be \$2 per day.

Fifth—For cars on which two men, a driver and conductor, are employed, the wages shall be \$1.75 per day each.

Sixth—No employe shall be discharged because of his connection with the movement or with a labor organization.

Seventh—All matters hereinafter causing disputes between employers and employes shall be settled, on request of either party, by arbitration. No strike shall be ordered either before or pending arbitration.

At the expiration of 30 days, the question of whether 12 or 13 hours shall constitute a day's labor, shall be submitted to arbitration, if desired.

(Signed)

W. W. PATRICK,
Pittsburgh and Birmingham.
W. T. WALLACE,
Southside Short Line.
R. H. KING,
Park Passenger and Pleasant Valley.
CHAS. ATWELL,
Manchester Lines and Union Line.
GEO. I. WHITNEY,
Central Passenger.

Master Workman Evans K. o signed, on behalf of the executive committee K. of L., and later the Oakland Line signed. The strike was then ended and traffic was resumed. The loss to the car companies by the eight days' idleness is variously estimated at from \$18,000 to \$25,000. The Allegheny and Manchester Company was probably the heaviest loser. Other companies which claim to be losing from \$1,000 to \$5,000 a year when they are running, did not regret the tie-up so much, as they say it is as cheap to let their cars lie in the stable as to run at the loss.

A later dispatch, dated the 7th inst., says: There is considerable dissatisfaction among the Oakland street-car employes, over the discharge of thirteen conductors, and another strike may be ordered. The company claims that the men were discharged to reduce expenses, but the employes say they were relieved because of their connection with the Knights of Labor. A number of the men quit work to-day, and cars were taken out by officers of the road.

* * *
TENNESSEE.**Memphis.**

The City Railway Company is making constant improvements in its equipment, and keeps a dozen men busy building new and repairing old cars.

The new street railway company expect to have a car-building and repair-shop as soon as the new stables are completed.

* * *
WISCONSIN.**Sheboygan.**

Mr. H. G. Northrop, of Chicago, has secured a twenty five years franchise giving him exclusive right to lay and operate street railway tracks in this town. The terms of the grant are very liberal, requiring no paving to be done within ten years. The route has been laid out, and will cover two and a half miles of single tracks, passing all the manufactories in the town, both railway depôts, the beer gardens and concert halls, with an extension to the cemetery and a half mile race track which is to be started this summer.

CARS FOR KINGS CO. ELEVATED ROAD— The Pullman Car Shops, Pullman, Ill., are at work on a contract for one hundred cars to be used on the new Kings Co. road, in Brooklyn. They are to be similar to the New York Elevated Road coaches.

FOREIGN ITEMS.

We quote from Joachim Miller, a few additional paragraphs concerning the Mexican street-railway route and environments:

"On down the streets we trundle, going out by the very street by which Gen. Scott entered forty years ago next summer. Color! Color! cheap color, and had art, it is true, but still it is color. These painted houses, with impossible horsemen and dancers and all sorts of things painted on the walls are "gin-mills" — *pulquer* shops. Thousands of flags flutter about and above the doors. But not the flag of Mexico. The government forbids the use of the national colors for such a purpose.

What kind of people in the cars? Look and see; listen! Cocks are crowing on either hand and under your seat. At least half a dozen big fellows—not Aztecs but Mexican "gentlemen"—have fighting-cocks in their laps, and are on their way to Tacalaya, where Gen. Franklin Pierce fought his way to the presidency, and where there are at least fifty mont' tables and ever so many cock-fights in full blast, at this season of the year. This busy, tumultuous, and most popular place in all suburban Mexico is just half way to St. Angel. We pass the gates by which the Americans entered, up the long, lofty, and graceful aqueduct, like that in ruins at Rome, only smaller; on, on, out the long lane of trees, over the "causeway" on which Cortez fought and where so many of his men found muddy graves with their loads of gold; on, to the base of Chapultepec. And the red-headed and belligerent roosters crowing and strutting, trying to get at each other as much as they can.

There are at least a dozen dogs in the cars. They growl and bark and snarl. But they are too lazy to fight, these dozen Mexican dogs. Heavens! From the fleas climbing up your legs and turning somersaults there, you would think there was nothing but dogs and fleas in the car. This is a good place to tuck your pantaloons inside your boots.

"Chapultepec!" cries the conductor. And the driver blows his brass horn. The crowded cars stop in a yard. Some old Mexican women with heavy baskets get out with great effort, every man helping them. Sometimes a pretty Mexican, Spanish, or half-Indian girl gets in or out. If she is very pretty you must not notice her much. You may give her a seat if you like; but it is had taste to even look at her for a second. She, on her part, will not lift her eyes to yours all day nor will you be permitted, under the laws of politeness here, to know she is near you. But, if you are very polite and want to do some woman a favor, you are permitted to exhaust your attentions on the old and ugly ones to your heart's content, and these are plenty. Yes, we can teach these people down here by the warm seas to plow, to plant, to cut grass, make money and machinery; but for solid, and honest, and unselfish politeness commend me to the Mexicans. The poorest Mexican in all this latitude can teach any New York American good manners any day in the year."

PARIS.—As it is well sometimes to compare our own condition with that of the less fortunate, we quote the following Parisian correspondence in order that our readers may understand how much better, on the average, we "run things" here, at home:

The present system dates back to 1855, so far as omnibuses are concerned, but not until 1874 were trams in use in Paris. It is due to the natural process of development, matured by an absolute monopoly, or rather a double monopoly, private and municipal, for the municipality derives even a larger share of the profits than do the stockholders.

A lease which does not expire until 1910, held by the *Compagnie Générale des Omnibus de Paris*, gives to this company the exclusive right to the entire city, and when the tramway company was organized, it could make no better terms with the omnibus company than to agree to lay its own rails, make its own investments, and then give the omnibus company three-fourths of its net profits. Of course it was not long before the tramway company failed, and so now, although the

the two companies still exist, the omnibus company has absolute control over the affairs of the other. It will be a long time before this dog in the manger is ousted.

Paris has no rapid transit system, and has no prospect of getting one soon. The municipal coffers derived 2,550,323 francs and the state derived 1,274,286 francs during the year 1884 (an average year), and it would not benefit either the national, municipal, or corporation treasuries to encourage a steam rail. According to the lease, the city has until now exacted a tax of 1,500 francs (\$300) per annum for each car used. From the beginning of 1886 to the end of 1910 the city will receive 2,000 francs per annum (\$400) for each car or omnibus, and, of course, in consequence of this exorbitant tax the number of cars is kept at the minimum. On most lines only one car every ten or fifteen minutes is run. The company must pay the city, besides this tax on vehicles, a heavy bill for rents for public stations on the streets, service of manure carts, street cleaning, and street paving, and duty on horse feed and materials for building the cars, and in order to secure this duty they are required to have their stables inside the city.

It pays to the State the customary taxes on property, the stamp tax on all its money transactions, and a salary of a government inspector.

Then, if the profits above all these taxes net over a certain amount, both the government and the city come in for a share of the excess. It is claimed by the omnibus company that 75 per cent. of the profits are paid in for taxes and rents to the city and State, amounting annually to nearly \$300,000.

The system is the most complete and the most complicated in the world. The style of car used has its advantages, however, and a sample car and omnibus have recently been sent to New York to be used as a model by the Fifth Avenue company. Thence it will probably find its way all over America. Its peculiarities consist in having seats on top and very large platforms for standing passengers. The largest of these cars are made to hold forty persons—no more—sixteen inside, sixteen on top, and eight standing on the platforms. When this number have taken their places, be they two-hundred-pound men, or fifty-pound children, a little blue sign is exposed at the rear of the car bearing the word "complete" and under no circumstances is another person allowed on the car. "Why, how good that is, never to be crowded," exclaims one reader. Yes, very fine for those in the car, but very inconvenient for the forty-first person, who is refused admission and must wait fifteen minutes for the next car. The cars and omnibuses have regular stations about a quarter of a mile apart, and seldom stop between stations. As soon as a person desiring to take a car arrives at a station he is given a ticket (gratis) bearing a number, and the passengers, thus numbered consecutively, upon their arrival at the station take their places in the car according to their numbers, and thus it often happens that a dozen men will crowd in ahead of a lady, whose number chances to be after theirs. If there is no room left after the men or boys are seated, the lady waits fifteen minutes for the next car—or hires a carriage. French ideas of politeness!

If it were not for the annual tax of \$400 on each car used—whether used for one day, or one hour, or all the year—a full supply of cars could be furnished and then the trouble would all be avoided. But now a cast-iron time-table must be followed which has been approved by the city police, and no matter how great the rush, the supply of cars is not increased. Often the car is filled at once upon its arrival at the terminus (at the Madelaine, for instance), but it is not allowed to start out until the expiration of its regular time.

The fare for inside passengers is 6 cents; for outside passengers 3 cents. In summer the seats on top are preferred, even by ladies. They are reached by a winding stair on the rear platform. A 6-cent fare entitles the passenger to a "correspondence ticket," with which he may continue his trip by a connecting route. The passengers are registered with a bell-punch as soon as they get on the car, and then if they do not pay, it is the conductor's loss, not the company's. An

extra man is employed to take up the correspondence tickets, with which the regular conductor has nothing to do. This often leads to disputes between passenger and conductor, since the correspondence tickets are taken before the conductor comes for his fares, and the conductor is obliged to trust to the word of the passenger as to whether he had already paid his fare with a correspondence ticket given to the other collector, who by this time has left the car.

So much for the complication of the Paris system. It has its good and bad qualities but it is safe to say that the hurrying, busy American public would mob any company that attempted to introduce so much formality in their street car traffic. The best line in Paris only runs a car every two minutes, capable of carrying forty passengers, even in the busiest hours. In New York, the elevated roads will carry a thousand passengers at six times the speed every minute, yet Paris is 50 per cent. larger than New York. Convenience, style, order, everything has its share of consideration here except the value of time.

But in the matter of horses and in the care of the same, the Paris Omnibus Company is the admiration of all.

The immense cars and omnibuses glide along over the smoothly-cemented streets, pulled by three of the plumpiest, prettiest, strongest horses that can be found anywhere. They are hitched three abreast, always well matched, well fed and well groomed. They go on a regular, easy jog, and rarely stop between stations. Even ladies, if they desire to get on the car between stations, must do so while the horses walk. I visited the largest of the stables a day or two ago, where nine hundred horses are kept for use on the line running from the Bastille to the Madelaine. The stables are built two stories high, with stalls in both stories. Two hospitals adjoin, one for sick horses and one for horses injured by accident.

Out of these nine hundred horses it is usual to have only four or five on the sick list at any one time. Every part of their care is conducted systematically. A scientist is paid a salary of 10,000 francs (\$2,000) a year to direct the feeding of all the company's horses, and he is continually experimenting on these thousands of horses as to what feed to give them and how often to feed them.

Until six months ago, beans were fed in large quantities to the horses, but now oats mixed with shelled corn is given. Carrots are fed in small quantities during the winter, as they are very cheap in France. Clover hay and wheat and rye straw are fed. The horses always stand on straw, the floors being stone. Nine kilograms (about twenty pounds) of the mixed grain are given daily, besides one kilogram of bran mixed with water, each evening. Under the present rule the horses are fed six times a day, the above portion being divided into six equal parts, and fed at regular intervals from 4 o'clock a. m. to 9 o'clock p. m. It is thought that the feed thus divided is more thoroughly digested. They are given water only between feeds, but always have all the hay and straw they want.

The feed costs from 40 to 50 cents a day. The company buys the horse when it is between 4 and 5 years old, uses it six or seven years, and then sells it. No horse is overworked. No horse works more than two hours a day. When the horse is young and new to the work it makes but one trip a day from the Bastille to the Madelaine and back, an entire distance of between five and six miles, occupying just one hour. Matured horses make two round-trips in two consecutive hours and no more. No wonder they are fat. Horses between these two classes make one trip in the morning and one in the afternoon.

There is one groom for every sixteen horses. The animal is well groomed just before starting out, and then as soon as he comes in from a trip, no matter how hot he is, the groom takes a bucket of cold water, a sponge, and a brush, and gives him a thorough sponging. It is forbidden to throw the water over a hot animal, but he is vigorously sponged and brushed.

HOT-WATER CAR HEATER.—The North Hudson Railroad Co. heats its cars by means of hot water in a series of 4-inch pipe sections, which are filled and placed in the cars before leaving the station.

NOTES.

NEW TURNTABLE.—Mr. Chas. Hathaway, of Cleveland, Ohio, has just patented a new turntable, which will be fully described and illustrated in an early (probably May) issue of the GAZETTE.

MULES FOR THE EAST.—Scroggin, Hudson & Co., Louisville, Ky., are making a specialty of mules for the eastern trade, under the conviction that these animals can be successfully adapted to that service.

IMPROVEMENTS IN TURNABLES.—Snead & Bibb, Louisville, Ky., are making various improvements on their iron-top turntables.

WOODLAND PARK, LEXINGTON.—Mr. Bert Cross, superintendent of the Lexington, Ky., Street Railway Company, has rented Woodland Park, an enclosure of about 15 acres, located within a mile of the business portion of the city, and is putting it in order for the summer season. The park contains magnificent trees; capacious ball grounds, with grand stand; rifle range; a lake stocked with fish, and having plenty of pleasure boats; a summer boarding-house, etc. A handsome dancing pavilion will be erected, and an open-air stage, where entertainments will be given regularly, and altogether every effort will be put forth to make it the attraction of the city, thus materially increasing the traffic on the street railway line.

DAFT MOTORS.—It is reported that the Acushnet Street Railway Co., of New Bedford, Mass., has contracted with the Massachusetts Electric Power Co., of Boston, to equip a portion of its road with Daft motors.

CAR ELEVATOR.—Messrs. Aitchison & Little, of Cleveland, Ohio, are building for the East Cleveland Street Railway Co. a hand-power elevator platform, 5x12 feet, 12 feet under beam. It is intended for raising cars to the second story of the company's barns.

MOTOR COMPANY.—On the 24th ult., certificate of incorporation was issued to the Hydro-Electric Railway Motor Company, at Chicago, Ill., to build and sell hydro-electric motors for driving all kinds of city street-cars; capital stock, \$500,000; incorporators, Charles Wandries, Jr., Henry W. Plum, and George Brauns, Jr.

CABLE ROAD CONTRACT.—We quote from a letter which informs us that "the building of the cable road on 125th street, from the North River to the East River—some two miles of double track—has been awarded to the Jonson Iron and Machine Foundry Company, and Andrews & Clooney, New York. The latter firm, on March 23, commenced laying the temporary track to accommodate the horse cars, while the cable road is building. It is to be completed ready for the wire rope, August 15, and is expected to be running September 1. This line is a part of the Third Avenue Road's system, which is operating successfully a cable road on Tenth avenue, the ultimate design being to extend the system from Harlem to South Ferry, at the Battery, through the entire length of Third avenue, the Bowery and lower Broadway. The contract price is understood to be between \$180,000 and \$190,000, exclusive of the tram and slot rails."

CAR DOOR FASTENER.—The fastener illustrated at another place is made by Wm. E. Haycox, 1158 Euclid avenue, Cleveland, Ohio. Price lists can be had on application.

FREIGHT CARS DRAWN BY ELECTRICITY.—Mr. John C. Henry, of the Henry Electric Railway Company, Kansas City, Mo., writes as follows: "On January 29 I hitched our electric car 'Paciniotti' to a K. C., F. S. & G. coal car, weighing 17,500 pounds, and took it up a 2½ per cent. grade. Yesterday I coupled the same motor car to C., B. & Q. box car 19,176, weight 24,500 pounds, and started it, without jerking, on a 3 per cent. grade. I claim the distinction of being the first to haul regular standard gauge freight cars by electricity, and would be pleased to have you record it."—*Electrical World*.

REMOVABLE SHOE.—The sectional horseshoe, illustrated elsewhere, is the patent of Wm. Somerville & Sons, veterinary surgeons, 127 Erie street, Buffalo, N. Y.

LIGHT LOCOMOTIVES.—The street locomotive, illustrated at another place, is made by H. K. Porter & Co., of Pittsburgh, Pa., who will mail an illustrated catalogue on application.

RAMSDEN'S CABLE RAILWAY CONDUIT.—The conduit illustrated under this title, in another column, is owned in Philadelphia, and Dr. E. C. Hine, 1834 Green street, Philadelphia, will furnish any desired information, on application.

CAR AND MANUFACTURING Co.—The Corey Car and Manufacturing Company, capital stock \$25,000, has been incorporated at Chicago, Ill. by Francis W. Corey, Joseph Gerstley, and Edgar Madden, to carry on the business of importing, manufacturing and dealing in cars, railway track, steel and iron rails, and railway supplies.

METALLIC STREET RAILWAY.—A well-known Cleveland, Ohio, concern has just completed the invention of a new metallic street railway system, and will shortly apply for letters patent thereon.

WANTED; FOR SALE; EXCHANGE

This department has been established as a medium of exchange and bureau of general information, for the convenience of those connected with street railway industries. Street Railway Companies wishing to dispose of or buy cars, appliances or stock, or having contracts to let; persons having vacancies to fill, or wishing situations, etc., etc., are invited to use this department without charge; being requested only to notify us when the object desired has been accomplished.

FOR SALE.—A number of second-hand "bob-tail" cars. Description and price will be furnished on application to "CLEVELAND," care STREET RAILWAY GAZETTE.

FOR SALE.—Fourteen second-hand cars, 12 feet long by John Stephenson & Co., N. Y., iron floor front platform; rear step and sliding door. Owner will repair, stripe and letter to order. Guarantee brakes bearings in first class condition, and put in 1000 on fare-boxes. All these cars are equipped with Baltimore wheels. Price \$365, f.o.b. in Indianapolis, Ind. Address Box Car, care STREET RAILWAY GAZETTE.

ADJUSTABLE SHOES.—A correspondent wants to know where the adjustable shoes mentioned in our last issue are made. Will some of our New York or Philadelphia subscribers kindly inform us where those used in these cities are made, and oblige. THE STREET RAILWAY GAZETTE.

WANTED.—A Street Railway, in Nevada, Missouri. A liberal franchise will be given. For particulars, address "Nevada," care of this office.

WANTED; POSITION.—By a practical Street Railway man of 10 years experience in the management of employees and office details. Also several years experience in handling money and tickets. Strictly temperate and can furnish best of references from past and present Street Railway Officers and others. Age 43. Address, S. J. AMBERT, 177 Bank St., Cincinnati, Ohio.

HORSE and MAN.

Their Mutual Dependence and Duties.

By the Rev. J. G. Wood, M. A.

Author of "Homes without Heads," etc., with Illustrations. 8vo. extra cloth, \$2.50.

"Certainly he has written one of the most valuable books about the horse and his proper care that have ever been issued from the press, for it makes very explicit statements concerning conditions that most books of its class fail to treat with anything approaching fulness, while it antagonizes in the most direct and positive manner common practices of the stableman and blacksmith. Some idea of the scope and method of Mr. Wood's book and of his manner of handling his subject may be gained when we say that eleven of his seventeen chapters are devoted to the foot of the horse, its construction, its proper usage, and so on. Mr. Wood not only finds plenty to say about horses' feet and their treatment, but says it very entertainingly; indeed, the book is a remarkable one for its entertaining qualities. It is not only full of information and important suggestions, but it is most charmingly written."—Philadelphia Evening Telegraph

For sale by all booksellers, or will be sent by mail, postage prepaid, on receipt of the price by

J. B. LIPPINCOTT CO., Publishers,

715 and 717 Market St., Philadelphia.

Barnum & Richardson Man'g. Co.,
64 South Jefferson Street, CHICAGO.

CHILLED STREET CAR WHEELS

FROM PURE SALISBURY IRON.

Curves, Frogs, Switches, Crossings, Etc.

To Any Pattern.

Light and Heavy CASTINGS for all purposes.

W. H. BARNUM, ALBERT ALLING, WM. E. BEST,
Pres., Lime Rock, Conn. Gen. Mgr. & Treas., Chicago. Sec'y, Chicago.

O. W. MEYSENBERG & CO.,

WESTERN AGENTS

Johnson Steel Street Rail Co.

JOHNSON STEEL GIRDER RAIL

AND STEEL ROLLED CURVES,

Switches and Frogs, also Metallic Ties,

185 Dearborn Street, Adams Express Bldg., CHICAGO.

ST. LOUIS, 204 North 3d Street, Gay Building.

C. A. PALTZER & CO.,
LUMBER
2598 Archer Avenue, CHICAGO.
Ash, Oak and other Hardwoods suitable for Car and Track Work.
WRITE FOR ESTIMATES.

Car Wheels
OF ALL KINDS
FITTED TO AXLES.
Street Railroad Turnouts,
Transfer and Turntables,
Car Drain Troughs and Furniture.
BOWLER & CO.
14 Winter St., Cleveland, O.



Chicago Malleable Iron Co.,
MANUFACTURER OF REFINED
Malleable Iron Castings,
Western Avenue & 26th Street,
CHICAGO.

Street Railway Work to Pattern.

Josephine D. Smith,
350 and 352 PEARL ST., NEW YORK,

Tin and Brass Box Lamps,
CHIMNEYS, BURNERS, ETC.
BRASS FINISHING.
METAL CAR TRIMMINGS REFINISHED.

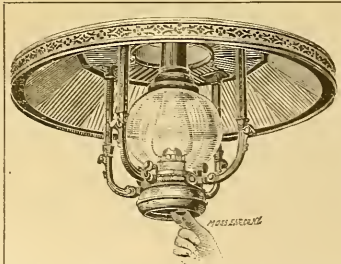

Manufacturer of Railroad Car Center Lamps and Reflectors.

A. WHITNEY & SONS, **CAR WHEEL WORKS** ESTABLISHED, 1847.
PHILADELPHIA, PA.

Street Railway Wheels, Axles and Boxes.

Littell's Improved Track Scraper

CLEANS THE TRACK OF SNOW, ICE, MUD, SAND OR STONE.

CONTROLLED BY THE FOOT OF THE DRIVER.

ADDRESS, H. H. LITTELL, LOUISVILLE, KY.

IXL

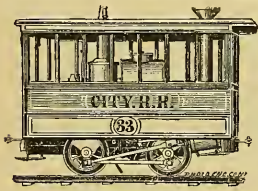

H. K. PORTER & CO.,
BUILDERS OF
Light Locomotives,
PITTSBURGH, PENNSYLVANIA.

Street Motors for City and Suburban Railroads, enclosed to resemble Street Cars, practically noiseless and smokeless. No steam is noticeable under ordinary conditions of the atmosphere. These Motors are adapted to steep grades and sharp curves, and either Flat or Tee rails.
Illustrated Catalogue and Photographs mailed on application.

This Space will be Occupied by an Illustrated Advertisement

OF

J.G. BRILL & COMPANY,

PHILADELPHIA, PA.,

MANUFACTURERS OF

STREET RAILROAD CARS

OF EVERY DESCRIPTION.

The Street Railway Gazette.

VOL. I.

CHICAGO

MAY, 1886.

NEW YORK

No. 5

TOM L. JOHNSON.

PRESIDENT, THE BROOKLYN STREET RAILWAY CO., CLEVELAND, O.

Tom L. Johnson, who has by his aggressive and enterprising methods in street railroading, attracted much attention during a number of years, was born, in 1855, in Scott Co., Ky., at the old homestead of his great-uncle, Richard M. Johnson, who, it will be remembered by students of history, was the hero of the famous Battle of the Thames, and who, it is said, was the slayer of the great Indian chief, Tecumseh, though the actual facts of the case have never, we believe, been settled.

Mr. Johnson appears to have had but few early advantages, beyond those of being born of good stock and amid advantageous surroundings.

His first business venture was made in Staunton, Va., where, at the age of twelve years, he embarked in trade as a newsboy, and we have heard him say with no little satisfaction, that he not only made the business profitable at the time, but has ever since considered it an honor to have been once a newsboy; referring to this phase of his experience with a pride similar to that enjoyed by Geo. W. Childs, the elder Bennett and other eminent men, who also looked back to similar beginnings.

At fifteen years of age, Mr. Johnson entered the office of the Central Passenger Railroad Company of Louisville, Ky., to learn office work and book-keeping. Before he reached seventeen years of age he was made secretary of the company, and in his nineteenth year became superintendent of the road; thus proving his natural aptitude for this line of work.

It has elsewhere been stated that Mr. Johnson is a son-in-law of ex-Governor Wm. H. English, of Indiana. This was a mistake; Mr. Johnson is in no way related to Mr. English, but married a distant relation of his own, — a daughter of Col. Robert A. Johnson, of Kentucky.

In 1876, he purchased a controlling interest in the Indianapolis street railroad lines, which interest he still holds. The Indianapolis roads were at the time of purchase, running twenty-four cars, and now run sixty-five cars daily.

The Brooklyn Street Railroad of Cleveland is a purchase he made in 1880. It commenced by running only four cars, and is now running thirty-six daily.

Two years ago Mr. Johnson became interested in the Southern Railway Company of St. Louis, passing through Sixth street to Carondelet, a distance of about seven miles. It is running twenty-five cars daily.

His first invention in the street railroad business was a fare-box, which is now used in Louisville and Indianapolis, and, in fact, all through the West and South.

The girder rail company was also organized on some of his patents, and hence was named: "The Johnson Steel Street Rail Company."

He is at present engaged in developing a new cable system, differing very much from any now in operation, mainly in its decreased cost of street construction, requiring a shallow conduit only seven inches deep, built entirely above the cross-ties. This system he has, in connection with several other street railroad men, experimented with for the past two years, and they now have in Cleveland a small road constructed on this plan, and expect during the summer to put the system in on some line in which they are interested, so as to demonstrate its success or failure on a large scale.

Personally, Mr. Johnson is a very companionable gentleman, having an easy and affable address, and being very cordial in his manner. He is young, successful and popular, and is possessed of indomitable pluck and energy, which carries him to his aim over all obstacles.

We can not close this brief sketch more suitably than by

requoting from our January issue:

"Mr. Johnson is a millionaire street railway magnate, and owes his wealth to his fighting qualities. Cleveland owes its present excellent street-railway system to him.

About five years ago Cleveland had the poorest street railways in America. Mr. Johnson purchased a wretched line known as the Brooklyn road, running to a suburb of Cleveland. He applied for the right to run his cars into the heart of the city over the rich but poorly managed West Side street railway. A bitter fight, often resulting in personal encounters, resulted in a victory for Mr. Johnson.

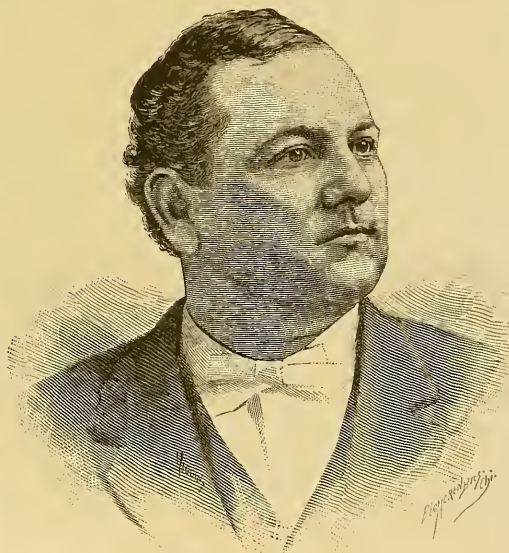

Tom L. Johnson

He paved whole streets in order to get the right to extend his line, and built it from the easterly limits of the city to Brooklyn. He carried passengers ten miles for one fare, and the Woodland avenue and West Side railways were forced to consolidate to meet his opposition. In the fierce rivalry that ensued Mr. Johnson resorted to many novel means to build up the business. He constructed a mammoth snow-plov and drew it over his lines with ten spans of "prancing white steeds" whenever snow obstructed the road. The public fell in love with him, and his cars were crowded. He purchased a base ball park on his line and had clubs play there. Sullivan, the prize fighter, was hired to pitch one game in Johnson's park.

He is a man of endless resources, and his methods have become so familiar that Cleveland is no longer astonished at anything he undertakes.

NEW CAR LAMPS.

The accompanying engravings illustrate a recent invention in car center-lamps. The mechanical features of the two designs are identical, the only difference between them being that one has a single, and the other, two lamps. They have been adopted for the coaches of the Long Island Railroad, and forty are now making for the 10th ave., (N. Y.) cable cars. The material is bronze, and the workmanship excellent.

The principal features other than the design proper (which speaks for itself) are that the wick is controlled (lowered or raised) by a small thumbscrew fastened to a rod which passes upward through the oil fountain and connects with the wick screw of the burner, so that it is not necessary to remove the oil fountain from the body ring or bracket to regulate the wick. The lower part of the globe is of concave transparent glass, and the upper part is of opal, which reflects the light downward and outward. The globes instead of being cemented with plaster of paris, the general mode of fastening, are held in place by a bayonet joint fastening, comprising a metallic chimney which serves as a passage for the products of combustion, rendering the several parts easily adjusted, and permitting the employment of a globe of any desired size.

MEDICAL ATTENDANCE FOR RAILROAD HANDS.

The New York elevated railroads have some 4,000 employés, including about 500 repair men, constantly on duty. This is an extremely large proportion of labor for repairs and track inspection, which is necessitated by the peculiar character of the road, and is a kind of work where the men are particularly exposed to accident and to injury to their eyes. The managers have, therefore, established a regular medical department, with one doctor for the eastern and one for the western division of the city lines, with facilities for prompt communication with any portion of the track. The company pays where men have to be taken to hospital, but its own doctors attend to the slight injuries, which are very numerous. A large satchel, with instruments, bandages, etc., stands ready for emergency, and is carried by the surgeons on duty. Among other functions discharged by the surgeons is the examination of employés for color blindness, sight, and hearing. Those not considered in sound condition are given other and less important positions, where these physical qualities are of less consequence. This medical attendance is without charge to the employés.—*Ex.*

"THE MILLS OF GOD."

The upper stones of which are law, the under ones order, may "grind slowly," yet sooner or later they "grind exceedingly small." We have time and time again called attention to the facts that to strike was to discharge one's self; that the act of discharge was a complete severance of the relations between employer and employed; that therefore interference by such discharged employe with his former employer's business is communism; that an attempt to destroy such business or property is anarchy; that the law-abiding community should awake to the fact that the sophistry of such pretexts as "greed of corporations," "rights of workmen," "organized resistance to organized robbery," were but gauzy veils half concealing the monstrous doctrines of the "Red Commune." We have been called partisans, alarmists, the mouthpiece and tool of tyrannical capital. We were unable to discriminate between the lawful demands of honest toil and the irresponsible acts of the hoodlum element. All this while "the mills of God" have been grinding. The millstones, law and order, have been relentlessly at work, until now public opinion forces from an indifferent or time-serving press sentiments of which the following is a specimen:

At such a time the public, we repeat, can not discriminate between men who throw bombs and shoot policemen and those who, through the practice of illegal methods, exert force in keeping men from work. This is no time to mince words. The workmen who have quit work with

the hope of bringing their grievances before the public know the truth of this. They must know that they are in danger of being misunderstood. They can not afford to take the risk. They should go to work, and when the crisis has passed they should enter upon negotiations looking to a fair settlement of their grievances.

There should be no hesitation. The people are in the field, and there are but two parties. One is made up of law-breakers and those who sympathize with them. The other is made up of those who place law and order above personal affairs. All these know that their homes, their business, the safety of their families, the prosperity of the country, all depends on the maintenance of law and order. To maintain the law and to preserve order they will go to most any extreme, and if they should in the face of a terrible crisis resolve to do relentless and even cruel things they will be justified. On the other hand the men who favor anarchy, who encourage law-breakers, will be judged harshly if they do the smallest thing in the nature of an offense against the law. There is only one thing for the strikers to do. They must go to work.

Truly, "The mills of God grind slowly,

Yet they grind exceeding small;

Though with patience stands He, waiting,

With exactness grinds He all."

[NEW METHOD OF GRIPPING AND CROSSING CABLES.

The accompanying illustration represents a mechanism consisting of two grips, the first of which seizes the cable to propel the car ordinarily, while the second seizes the cable during the passage of the first one over a crossing cable. As the forward grip approaches another cable, which may cross the first one at any angle, the carrying pulleys run up an inclined plane, automatically close the back grip upon the cable, and release the forward one; the car is then propelled by the back grip. As soon as the front grip has passed the crossing cable, it falls in position over its own cable, which it is made to seize by a lever, when it again propels the car. The back grip, passing up the inclined plane, frees itself from the cable, and, passing over the crossing cable, drops in position with its jaws open over its

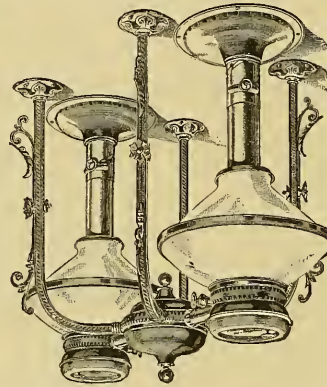
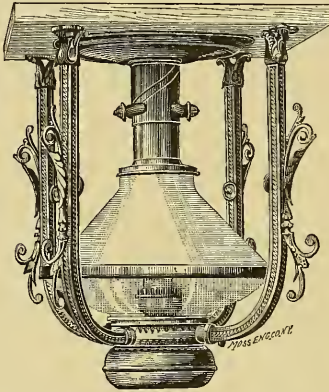

own cable ready to be called into action at the next crossing. With this grip it is easy to switch from the cable of one road and go upon the cable of another running at right angles or at any other angle to the first. The action is positive all the time, thereby rendering unnecessary the dependence upon momentum to carry the cars anywhere when the grip is loosened from the cable; curves are rounded easily and without trouble.

The frame supporting the parts consists of bars extending beneath the car from axle to axle, and united by cross bars. Firmly secured to two of the cross bars are two vertical hollow slide posts, M, connected at the top by a cross girt, in each end of which are two pulleys. Under the posts are pulleys placed in line, with the outside ones on the cross girt. A cross head, K, formed with rectangular slotted ends, slides vertically between the posts. Chains pass from each end of the cross head around the lower pulleys, through the post and over the upper pulleys, to adjustable eye bolts, thus forming a parallel motion for the cross head, which is reciprocated by operating the lever, S,

A short plate of sufficient thickness is dovetailed to correspond with the dovetail of the vertical plate, to which it is hinged by a bolt; the short plate fits snugly between lugs on the other, and projects above and outward from them. The end of the projection is forked to admit one end of a link, whose other end is joined to a plate, A, sliding freely between the forks of the vertical plate. The upper end of the sliding plate, A, is connected with bell cranks having their fulcrum pin in the top of the vertical plate. The opposite end of the bell cranks is attached to a rod leading to the lower end of the lever, R, by means of which the short plate or movable jaw can be operated. The cross head, K, supports all the parts of the main grip.

To the two rear cross bars of the frame are secured triangular plate, P, slotted to receive a cross head which supports all the working parts of the auxiliary grip. The triangular plates are set wide enough apart to allow for the side motion of the car when passing curves or irregularities of the track, without impeding the passage of the grip through the slot. That portion of the auxiliary grip operat-

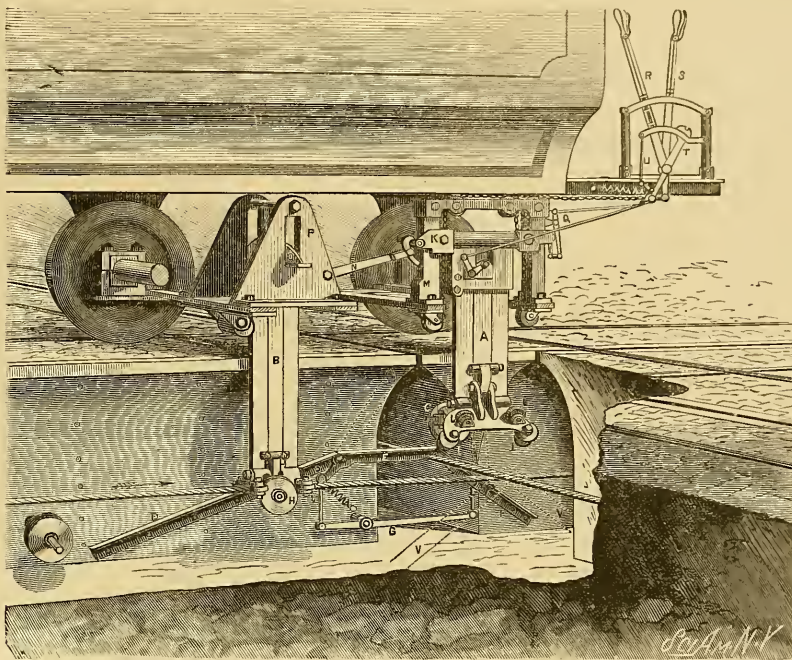

to the lower end of which it is connected by a chain. A link is fitted at its top end to oscillate freely on the central cylindrical part of the cross head.

The lower end of the link receives the ends of a forked plate, of proper thickness to pass freely through the slot of the conduit; the joint is so formed as to permit the plate to oscillate in the link, thereby allowing of side motion of the car while rounding curves, etc., without its materially affecting the passage of the plate through the conduit slot. The closed end of the plate is closed backward and dovetailed across its face, to receive a friction block; below the dovetail it is bent still further back to serve to guide the cable to its grip when the latter falls to the normal level of the cable. On one side of the plate is a roller, C, for carrying the grip up the inclined plane, D, in the conduit. On each side of the lower part of the grip are horizontally placed rollers so disposed as to be opposite the strain of the motor when rounding curves to the right or left. At each end is a carrier pulley for carrying the cable while the car is stopped.

ing in the conduit is the same as the corresponding portion of the main grip. In the upper end of the sliding plate, B, is a spring inclosing a guide bolt attached to a block sliding vertically in the plate. To the sliding block is connected the lever, N, having at its other end a pawl, L, acted upon by a pin in the cross head, K, of the main grip.

The operation of the device will be easily understood. By operating the lever, R, the movable jaw of the main grip is closed, and the carrier pulleys are passed under to secure the position of the cable between the jaws. Then, by operating the lever, S, the main grip is raised high enough to clear the pulleys in the conduit. Simultaneously the cable is raised into the jaws of the auxiliary grip, and they are closed so as to barely grasp the cable by the connection of the lever, N, with the cross head of the main grip.

By further operating the lever, R, the jaws of the main grip are closed until the cable is firmly held. Thus by manipulating the lever, R, the cable can be sufficiently released, without its being dropped, to allow of stopping the

car. Also the cable can be entirely released from both grips, and by means of the lever, S, can be instantly picked up. On arriving at the flange, D, the roller, C, of the main grip passes up, and raises the main grip and cable. When it has lifted a short distance, the pin on the end of the cross head, K, acts on the pawl, L, of the lever, N, thereby closing the jaws of the auxiliary grip firmly on the cable. At the same time a projection on the opposite end of the cross head operates the lever, Q, which, through suitable connections, releases a catch on the lever, R, which is then moved by a spring, and the jaws of the main grip are opened to drop the cable.

As the roller, C, passes on, the flanges, E and F, are closed to form a path over the crossing cable. As the cross head, K, descends, it acts on the pawl to open the jaws of the auxiliary grip; the cable is then grasped by the main grip as before. It will be seen that the car is propelled

the problem may be met as it arises, first, locally, and then for transportation through longer distances.

The endeavors made to supply these wants are seen on every hand. Probably most would agree that the time of increased facilities for transit is coming. The world will never go back to slower speed. The tendency is indeed precisely opposite; that is, to save time, shorten working hours, and to concentrate the volume of transactions in centers of business or of trade. Whatever this progress of business and of life demands will be developed and put into practical use.

Fifty years ago there existed only the very beginning of the present great development of the surface railway system, which has cost in the United States alone nearly seven thousand millions of dollars, and employing three hundred thousand men, with an extent at the end of the year 1884, of 125,379 miles.* They transported last year 334,814,529

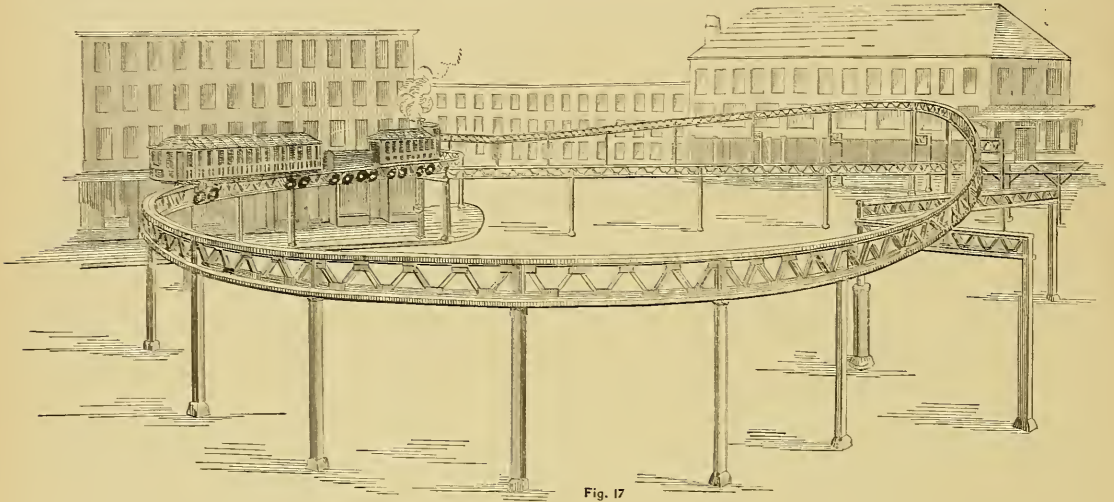

Fig. 17

over the crossing cable by the positive action of its own cable, and under any conditions the grips are not liable to come in contact with the crossing cable. The claims of this grip have been satisfactorily demonstrated by a model one-fourth working size.—[By courtesy of *American Engineer*.]

RAPID TRANSIT AND ELEVATED RAILROADS.— WITH A DESCRIPTION OF THE MEIGS ELEVATED RAILWAY SYSTEM.

It would be difficult in a paper of reasonable length to treat a subject having so wide a bearing as that of rapid transit, with the exactitude and thoroughness of detail which might be expected in a technical article. The following notes are therefore with hesitation submitted, in the hope that the incomplete form and in some cases the mere suggestions which only can be presented within the limits of this paper, may be accepted in place of a more extended treatise.

The modern demand for increased facilities of transit is twofold. First, there exists an imperative need of better means for the conveyance of passengers within all our large cities, making the problem an universal one, although its attempted solution has thus far been local. Second, there is the more general demand for more rapid means of communication between cities and important centers of population or business.

It is the present purpose to show what the existing requirements are, as indicated by their gradual development, for obtaining with safety a higher speed of transit, and how

persons, and earned in gross \$770,684,908, with interest and dividends paid to the amount of \$269,939,137.

Previous to this the most rapid methods of transit, still within the memory of older men now living, were only post-riding and the now primitive stage coach. Not even the horse car had been invented. Later on, the horse railroad system took its place in the streets of our principal cities, and although not developing much increase of speed, its great convenience, as well as the economy shown by the introduction of the principle of carrying passengers by rail, as compared with any other method of land transportation, has caused the growth of this system to the extent of many miles of track and great perfection of detail. In Massachusetts, the present extent of the street railways is 310 miles, as compared with 2,857 miles of steam railways in the State; their value \$12,410,631, carrying 94,894,259 passengers in 1884, and employing 3,846 men and 8,996 horses, as compared with about 16,000 employes on street railways in the whole country.

The horse railroad has had so important an influence in the building up of suburbs and extension of the growth of cities as seemingly to have become an absolute necessity; yet so great are the present objections in blocking the streets, failing to supply sufficient accommodations to the public, and loss of time by the delays incurred by passengers, that in the East, at least, it is becoming the general opinion that its limit of capacity and usefulness has been reached nearly if not fully.

* From Poor's Manual of R. R.'s, 1885. Cost of Roads and Equipments, \$6,024,554,444. First Railroad completed in Mass., 1827; first locomotive run Aug. 8, 1829.

While this system has been growing and other methods of obtaining relief from the crowded state of the streets and the consequent retarding of transit have become established, such as the London underground railway and the Vienna depressed railways, a system of elevated railways has been developed in New York City of which the results attained in the short period of time since 1872 have been extraordinary. Not only have these demonstrated the fact, not before proved or deemed hardly practicable, that a complete steam railroad system could be run upon the tops of a line of posts set in the streets, as in the Bowery line, with entire safety, speed and convenience, but the permanent success to the principle has been, I think, fully demonstrated. A short statement of their progress is inserted, from a recent paper. "During the first year the roads carried 170,000 persons, and during the past year nearly 100,000,000." "The first year's earnings were \$17,000; last year nearly \$7,000,000." "There was a steady progress each year." "The aggregate earnings since the road was first built have been \$32,000,000; the aggregate passengers carried 444,000,000."

Such being the facts, let a moment's glance be given at the local conditions existing in cities. Experience has shown that ease of communication in the transaction of business requires its concentration into the least possible space. A street too wide for business purposes is more detrimental than one too narrow. The result has been the erection of five, seven, and even nine story business blocks, which, with the general introduction of fast running elevators, supply the demand for offices and warerooms, and are more valuable for business purposes than lower floors farther removed from the business center. Now, with this great concentration and consequent increase in the volume of business through the streets, the capacity of the streets themselves has not been increased proportionately.

The result has been a blocking of the streets to a large extent, and the obvious remedy, if the height of buildings is doubled, is to have two-story streets, so to speak, *i. e.*, to relieve their crowded condition and divide the travel by some form of elevated roadway which shall take from the surface that portion of it which desires merely transit as quickly as possible, and thus relieve the one portion from its blocks and convenience the other.

We must either have rapid transit upon the surface, under it, or above the surface of the ground. The first is impracticable, for reasons to be shown later on, while the second is open to the same objection, on account of the limited field available caused by its excessive cost.* For general usefulness, the only feasible method is the third.

Objections to this remedy have been of two kinds: first, the alleged damage to property adjacent to an elevated lien of railway; and second, the sentimental one of injury to architectural features of the buildings. The first should be at once recognized where real damage exists and met so far as practicable by the road. A new element has been intro-

duced with the elevated railway, disturbing the existing business relations and property interests, which latter can not defeat the railroad, but which must be readjusted after the introduction of this new element. The injury done in places, whether the abuttor's land is held to end in the edge of the sidewalk, as in New York city, or extends to the center of the street, should be compromised between the railroad and property interests, in equity, by the payment of damages, in case either of direct damages by land taken, or of consequential damages, if proved that the rent or income from the property is thereby diminished; but these cases are only incidental in comparison with the great and lasting benefits to the public at large. As to the second objection, it may be said that the demands of transit should be first met, with as little loss in other respects as possible. The primary use and purpose of the streets is for transit, and not for the display of the architectural features of the buildings lining them. Opposition to these necessary facilities for

transit, while somewhat surprising when the great benefits to be derived from them are considered, is yet to be expected when we review the history of the introduction of railroads to supersede the turnpike and the stage coach, the introduction of the horse railways even, or that of any of the great improvements, such as many in the process of manufactures, which have destroyed the value of some class of property which they supersede. All such must, in the end, give way to the public need.

While it has been found that the elevated system is best adapted for long-distance travel, *i. e.*, for distances exceeding a mile, the reverse is true of the horse railway, which will still be found better fitted for the accommodation of some portion of the short distance passengers than even the elevated railway. Where the time required for conveyance is short and speed therefore not an object, considerations of convenience will still lead the

short-distance passenger often to prefer to step upon the cars of the horse railway, which goes directly where he wants to go instead of climbing up a flight of steps into an elevated railway car which may not leave him so nearly at his destination; and especially will this continue to be the case, if as now seems likely, its service becomes improved by the use of electric motors, in the near future.

For the increase of transit facilities, certain definite requirements should be met in any successful system. These may be regarded as those of, first, *safety*; second, *speed*; and, third, *convenience and economy*.

The leading features of the surface railway system, *viz.*: first, *the rail and car*, for the reduction of required motive power and dead weight carried per passenger to their least amounts; and second, *the truck system*, having independent moving trucks, coupled, supporting upon them the platform and body of the car, should be retained.

Under the requirements for *safety*, should be noted, first, safety from derailment, since next to railroad accidents occurring to persons crossing or walking upon the tracks, which are not reported, more than one-half of all reported railroad accidents are from this cause; second, safety from

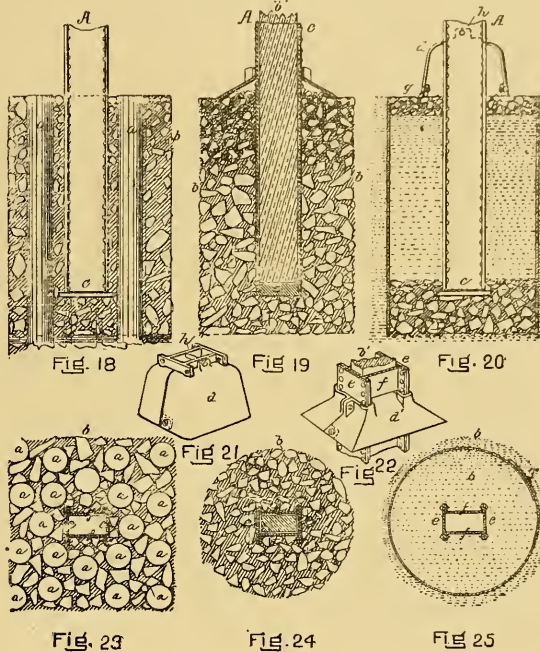

* The proposed underground railway for Broadway, New York, is estimated to cost from \$300,000 to \$1,400,000 per mile, for single and double tracks, respectively.

obstructions upon the track. These consist of passing teams, trespassers and cattle, rocks and timber falling upon it, wash-outs, which are of the nature of obstructions; in winter, the blocking of the tracks by snow, drifting of the same, and many other causes resulting from railways built at grade, or upon the surface of the ground; third, an efficient brake system should be provided that will act automatically should the cars break apart or other derangement occur; fourth, appliances to give the engine-driver positive and absolute control not only of the engine, but over the movement of the entire train.

Among the requirements for any material increase of speed, are, first, those insuring at least equal safety to that now existing under the increase proposed, such as holding the truck upon the rails by flanges or their equivalent, so that no derailment can possibly occur by the trucks lifting or jumping away from contact with the rails; second, the center of gravity of the engine and cars should be lowered and the stability of rolling stock increased, to prevent strains which would overturn them; third, more secure attachments between the truck and car body should be provided, to prevent the momentum of the car body from breaking away from the former; fourth, there should be provided an improvement in the design of motive power, especially by the use of independent means for producing adhesion of the driving wheels to the rails; or a controllable and variable adhesion, not dependent upon the weight of the engine for the pressure of the driving wheels upon the rails; fifth, a consequent saving of weight both in engine and cars, with the same power of engine, and reduction of the dead weight carried per passenger, should be reached; sixth, for speed, a clear line to be provided, with no crossings at grade, and the use of an efficient block system.

For the attainment of *convenience and economy* the system used should be adapted:

First. For curves of shorter radius than have been heretofore practicable, especially in cities, where streets are narrow; and for through lines, a better alignment as to grades and curves, made possible frequently only where the track is raised above the surface. Second. For economy in repairs, by possessing freedom from wash-outs or settling of the ground, and from the decaying of cross-ties.

It will be seen that most of the above requirements can be met and the result in view reached only by the employment of an elevated system. It is the belief of the writer that all steam railroads, excepting perhaps those only for freight having speeds of less than ten miles per hour, should be elevated from the surface of the ground because of the many advantages of such a construction, as will be shown more fully in the further discussion of the subject. In Massachusetts, a resolve of the Legislature,* referred to the Railroad Commissioners, looking to the feasibility of a gradual abolishment of all grade crossings in the State has already been passed, and this may be regarded as a first step in the direction indicated.

To show that many or all of these conditions may be fulfilled in concrete form and may exist practically, the problem will be illustrated by the selection and brief description of one of the several distinct systems, each containing some excellent features, that have been proposed, namely, that of the Meigs elevated railway system.

This plan, invented and developed by Captain J. V. Meigs, of Lowell, Mass., as the result of over ten years' careful study of the surface roads, their advantages and defects, is unique in that it is a complete system, one part absolutely depending upon the others, and having little or no analogies in the surface roads.

It may be regarded as a development from the New York elevated system, taking for its starting point the fact only that a railroad can be built and successfully run upon a single line of posts.

Objects.—The Meigs elevated railway system is designed

**Resolved*, That the Railroad Commissioners examine and report to the next Legislature upon the subject of providing for the gradual abolition of grade crossings in cities and the populous parts of towns." [Approved, April 19, 1884.]—*Report of R. R. Com.*, 1885.
*A Application for patent filed May 16, 1873; issued May 11, 1875. Earliest notes made in 1867 or 1868.

to meet the modern demand and all the ordinary requirements of a railroad for the safe, quick and convenient transportation of passengers in cities, or to and from the suburbs of cities to such central points as passengers desire to go; while on longer lines, connecting cities and towns, to carry passengers and freight not only more economically and safely, but more speedily than has heretofore been done.

The New York structure is essentially an ordinary railroad, elevated, and is open to the criticisms of liability to derailment and consequent want of safety; a too great height of the position of the center of gravity, and want of stability, by reason of the large leverage upon the posts when sustaining wind pressure upon the sides of the cars; and the well-known obstruction to light and air produced by the size of the structure in the street.

The fundamental principle of construction in the Meigs system is to *concentrate the strains due to the loads upon the track directly upon the central line of the way*, avoiding all disadvantageous leverage. It is, in effect, to turn the ordinary track up edgewise, or vertically, with one rail lying directly over the other, instead of side by side in a horizontal plane, as in all other railroads. Or, it is as though the Y of the posts in the New York system as well as all the cross-ties, nine feet in length, were abandoned, and the double girder beneath the track condensed into a single central truss, removing four-fifths of the material causing obstruction to light and sight from the street.

Its general appearance is shown by Fig. 17.

In the execution of the design based upon these peculiar conditions, the roadway consists of a single lattice iron girder, or truss, four feet in depth, and resting upon iron posts or columns placed 44.4 feet apart.

Distinguishing Features.—Its peculiar features and differences from the ordinary railroad exist in

1. The Way;
2. The Switch;
3. The Trucks;
4. The Passenger Cars;
5. The Engine;
6. The Draw Bar, and
7. The Brakes;

as in the following description:

I. THE POSTS AND FOUNDATIONS.

The posts may be of wood, rough, hewed or sawn square, for the wooden track system; or of iron when the iron way is used. In the latter case they will be of rectangular form, about 11 inches by 10 inches in section, and 24 feet in length. They are composed usually of two medium 10 inch channel bars, *ff*, Fig. 22, and two plates, *ee*, all about $\frac{1}{2}$ inch in thickness, riveted upon and along the flanges of the channel bars and the edges of the plates. They thus form a hollow box-like structure, which may be varied in cross-section or thickness in special places, or may have the solid plates replaced by diagonal bars riveted in lattice form upon the channel bars. The weight of each post, having a sectional area of 23.8 square inches, is 1,919 pounds, the crushing load 235 tons, and safe load 39 tons, while the greatest load that will be imposed on a post in any position of a passing train will not exceed 35 tons.

The foundations, as shown in Fig. 18, this and all subsequent figures being in scale $\frac{1}{32}$ of full size, or $\frac{3}{8}$ inch to the foot, being a vertical section, and Fig. 23 a horizontal section of one form, consists of a plate *c*, upon which the post rests, of somewhat larger area than the post, as shown in Figs. 18 and 20, or of a similar plate, *c'*, as shown in Fig. 19, which has an upwardly presenting boss entering into its interior, set in and on a concrete foundation about 3 feet in diameter and six feet in depth. The lower part of the posts may remain hollow, or they may be filled with concrete, *b'*, or with sand or other non-compressible filling, as shown in Fig. 19.

If the foundation is upon soft earth, the earth is packed, as shown in Figs. 18 and 23, by driving piles, marked *a*, all around the place where the post is to be set, and filling between, and over them, if necessary, with the concrete.

Where this is not necessary, another plan, shown in Figs.

19 and 24, is more usually followed, in which the post hole is simply filled with concrete and broken stone below.

Where the ground foundation is good, but the surface soil is mobile, as in the Mississippi valley and elsewhere, in which case side thrusts are not well resisted, still another method, shown in Figs. 20 and 25, may be employed, consisting of a stout resistant box or lining to the post hole, of iron or wood, as shown at *g*, and filled with concrete or sand inclosed between concrete ends, thus forming a strong side support to the post, practically increasing its section below the ground many times. At the surface of the ground the posts may, if advisable, be additionally braced or guarded from abrasion and injury by passing vehicles by means of caps or collars, *d* or *d'*, shown in Figs. 21 and 22. These are either of cast or wrought iron, made in two parts, and bolted together and to the post by means of ears or bolts passing through the post.

These posts, so set, at a distance of 44.4 feet apart, will be amply sufficient in strength to carry safely a girder capable of supporting substantially such trains as are now in general use, at a height of at least 14 feet from the ground to the bottom of the girder.

[To be continued.]

ELECTRIC RAILWAYS.

Germany has been fortunate in having its first electric railway undertaken by Siemens & Halske. This firm brought to bear upon the problem the profound researches and the engineering education of its staff, and acting in the cautious and thorough manner resulting from its wide experience in many fields of engineering, has been successful. In the exhibition of Berlin, 1879, they established a circular railway of 350 meters length, one meter gauge, and placing a three horse-power motor in a car capable of carrying thirty people, transported passengers at a rate of fifteen to twenty miles per hour. The current was taken along one rail, and by an insulated tire was conveyed to the positive pole of the motor, and thence to the other rail, by which it returned to the generating dynamo. No special care was taken to insulate the rails, which were placed high above the ground on wooden ties. The current was of low electromotive force, and therefore did not require special means for insulation. This road was exhibited in Dusseldorf and Brussels, and finally in London in 1881.

The success of this experimental plant was uniformly so great as to make Messrs. Siemens & Halske desirous of building an elevated railway in Berlin, for which the plans and estimates were made with great care, but unfortunately this enterprise was not carried out, because the Emperor William would not permit "The Linden" to be marred by being crossed at one point, and because the citizens objected to having people looking into their second-story windows.

The carefully made estimates of this road may be of interest as showing the minimum of cost of good work, upon the authority of engineers thoroughly conversant with their profession.

ELEVATED RAILWAY IN BERLIN, ONE METER GAUGE, 6¼ MILES LONG, WITH SEPARATE MOTOR FOR EACH CAR.

| | |
|--|-----------|
| Railway structure and ten stations..... | \$305,000 |
| Ten carriages, seating fifteen persons each..... | 15,750 |
| Steam engine, boilers and dynamos..... | 9,750 |
| Buildings..... | 5,925 |
| Land..... | 22,500 |
| General labor..... | 3,575 |
| Total..... | \$362,500 |

Current Expenses.

| | |
|--|----------|
| Wages..... | \$10,950 |
| Fuel..... | 5,550 |
| Oil and waste..... | 250 |
| Lighting..... | 400 |
| Depreciation and repairs: | |
| Three per cent on \$312,500..... | \$9,375 |
| Sixteen per cent on \$25,000..... | 4,000 |
| | 13,875 |
| Interest on capital (\$377,500) at 5 per cent..... | 18,875 |
| Total..... | \$49,400 |

It was proposed to run electric cars each day at a fare of 2

cents per mile, and would have proved a paying investment had it obtained the equivalent of six passengers for a whole trip for each car.

Failing in this, Siemens & Halske obtained a charter for a surface electric railway from the Berlin military academy to Lichtenfelde, a distance of a mile and a half, which was opened in May, 1881. This road was constructed upon the ground after the manner of ordinary roads, save that a bowed fish-plate connected the rails so as to permit contraction and expansion. Again, only two rails were used, one conveying the current out from the dynamo, and the other returning the current to the dynamo. Very little resistance was found, owing to the large cross-section of the rails used as conductors, and consequently low potentials were found practicable. Very great success has attended the running of this road, and it has been extended to Tetlow and Potsdam, making in all some eight miles of road in successful operation upon ordinary roadbed with wooden ties and steel rails. Insulated wheel-tires are used to take off the current.

At Paris the law required flat tram car rails, not projecting above the street level; and the presence of dirt would have interfered with the passage of the electric current from the rails to the wheels; so overhead copper conductors, and trolleys running along the conductors, and connected to the car by flexible wires, were used. In the mines at Zankerode, Prussia, Messrs. Siemens used two overhead rails for conductors, as the condition of the track prevented its use. A separate motor, weighing a ton and a half, drew loads of eight tons at a rate of seven or eight miles per hour. In other cases, Siemens & Halske have found it advisable to use a third rail, or separate copper conductor connected with the positive pole of the generating dynamo and have connected the negative pole with one or both rails of the roadbed. The Portrush and Bush Mills electric railway, six miles long, has used a third rail so placed as to be free from dirt, and has been in successful operation for several years. Besides the Portrush railway, there are now in successful operation electric railways at Brighton and Blackpool. Dupuy, at Lisieux, France, has arranged a locomotive for use in the bleaching fields of a bleaching works. The power is carried in Faure accumulators on the locomotive. Recently we have the experiments upon the Reckenzaun secondary battery tram-car at the Antwerp exhibition, which proved itself the superior, in many ways, of the steam and compressed air motors entered in competition with it. When we compare the indicated power of the engine charging the secondary batteries with the power developed in moving the car, we find an efficiency of from 30 to 40 per cent. in this case. It is impossible to doubt the ultimate success of electric railways when built with sufficient knowledge and engineering skill to assure their adaptation to the purposes which they must subserve. The successful outcome of the work of Siemens & Halske prove this beyond a doubt. The possibility of attaching a motor to each car enables us, with very little loss of space, to have each car independent of any separate locomotive, and to utilize the adhesion of all the wheels, and load. The counter electromotive force of a dynamo used as a motor, being proportional to its speed, renders it to a certain extent automatic, so that, being at rest, the current passing is the most intense, the torsion is a maximum, and the car starts with a great pull. If the car slows on an up-grade the pull at once increases, and, if it goes faster on a down-grade, the counter electromotive force increases, the intensity of the current diminishes, and the demand for power upon the generating dynamo and engine is reduced. The application of power to each car avoids the necessity of an extremely heavy locomotive, and allows of a great diminution of the weight and strength of bridges and viaducts. The enormous traffic on these roads taxes to the utmost the carrying capacity of the steam plant, which is the result of half a century of study and modification of machinery of locomotives and cars. The substitution of electric motors for steam locomotives will be a gradual process, and will progress just in proportion to the engineering skill brought to bear upon the problem.

CONSTRUCTION, EQUIPMENT AND MAINTENANCE OF AMERICAN STREET RAILWAYS.

BY AUGUSTINE W. WRIGHT.

(Continued from page 101.)

VIII.

THE GIRDER RAIL.

Among the advantages offered by this type of rail, I place:

First. The fact that it is fastened to the cross ties at its bottom, below the action of all passing traffic.

Second. Its increased stiffness and consequent absence of vibration under superimposed loads.

Third. The absence of timber stringers.

Fourth. Better joints.

It needs no words of mine to satisfy you of the importance and value of the fact that the spikes are protected. All motion of the rail is prevented vertically, and in contracting or expanding under varying temperatures, it slides *through between the spike heads*. In the flat rails this motion cannot take place without moving the spikes more or less along each side from the centre to the rail end; and practically it is irresistible.

As to its increased stiffness. The ordinary step rail possesses so little vertical stiffness that the timber has to carry the entire load. The rail would deflect to such an extent that the timber would break. The elastic limit differs in the rail and the timber. The centre bearing rail is stiffer than the side bearing.



FIG. 23.

A. J. Moxham quotes the following: "Tests for transverse strength made at Cambria Iron Co.'s Works, Johnstown, Pa., June 7th, 1883.

Supports 17 inches apart, rails all steel.

1. Tram rail, weighing 45 lbs. per yard; depth of head $1\frac{1}{2}$ inches; width do., 2 inches; depth of flange 9-16; width do., 3 inches. Total width 5 inches. Elastic limit 15,000 lbs. Ultimate strength 32,000 pounds.

2. Test of same rail on pine stringer 5 inches wide and 9 inches deep.

At 20,000 lbs. timber much compressed. Signs of yielding.

At 25,000 lbs. timber commenced to crack.

At 27,000 lbs. timber gave way, the two ends thereof were compressed $\frac{7}{8}$ inch, having reduced the depth to $8\frac{1}{2}$ inches.

3. Test of Johnson girder rail weighing 52 pounds per yard.

Elastic limit 80,000 lbs.

Ultimate strength not reached by machine. At 122,000 lbs. the permanent deflection was $\frac{3}{4}$ of an inch."

The quiescent breaking load of a horizontal beam, supported at both ends and loaded at the centre, is found by multiplying the square of its depth in inches by its breadth in inches, and this sum by a coefficient found by experiment, and dividing the product by the clear span in feet. This stringer being 9 inches deep and 5 inches wide, and of pine, whose coef. has been found to be 500 lbs., and clear span 1.42 feet, we have $\frac{9^2 \times 5 \times 500}{1.42} = 14,265$ lbs., which

would have been its breaking load, had not the rail distributed the weight. As a rule this girder rail is five times stiffer than the step rail and stringer. The rule for stiffness follows a different law. The deflection within elastic limits of a rectangular beam is in proportion to the load multi-

plied by the cube of the span, divided by the breadth, multiplied by the cube of the depth.

The absence of timber stringers.—Upon most of the mileage of street railways of this country, the rails outlast the stringers! It is poor economy to lay old rails upon new timber!

"No man putteth a piece of new cloth onto an old garment."

Practically, therefore, the life of the timber should measure the life of the rail, but in this event more or less good metal is thrown away!

I thought that for all street railroads with LIGHT traffic the girder rail was unquestionably the best, but for lines with HEAVY traffic, where one stringer would last as long as two rails would wear, the wooden stringer was preferable. Further consideration has convinced me that the girder rail is better, so far as the track is concerned in all cases. Why did my steel rails wear out and have to be replaced within less than 5 years? Because of the wretched fastening and consequent vibration. I am of the opinion that the better fastening, greater stiffness and better joint of the girder rail, will prolong its life to a point beyond that of the wooden stringer! *Permanency* is what all street railways desire in their track construction. Besides the in-

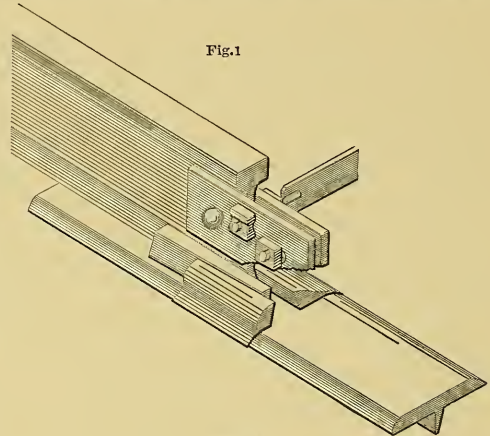

FIG. 24.

convenience to the public in track renewals, the loss to the company is great. \$500 per diem does not cover the decrease in receipts upon many a line from traffic interruptions; and if rival lines exist, a portion of this sum is permanently lost to the company, for men are creatures of habit, and are apt to continue to use a line after becoming accustomed so to do. Half the cost of a street railway or more is in the pavement, and this must be more or less destroyed in renewing the tracks.

Under the head of "Joints," I have written upon those in use for the ordinary rail. The girder rail permits of a fish plate joint, infinitely superior to any that can be made for the flat step rail. If the fish plates are securely fastened, of suitable form and strength, the load upon the street rail is not great enough to get them out of order. They hold the rails in line horizontally and vertically, and the improved joint saves to the company horseflesh, wear and tear on cars; its popularity is increased with its passengers to the same extent, by an absence of a jolt or jar 176 times per mile if the rail joints came opposite, and the rails are 30 feet in length, or 352 joints when they do not come opposite.

As remarked upon a previous page, no dependence should be placed upon the pavement to hold the track to gauge. On all metropolitan lines tie rods should be used not more than seven feet apart. I would recommend a rectangular bar rather than a round rod, as offering less obstruction to paving.

Seven or eight inches, at least, in depth should be furnished, from the top of the pavement to the cross tie. This is provided by the use of chairs, extending from the bottom of the rail to the cross tie, and the attachments between the rail and chair should be such that the rails can be removed when worn out, without having to go down to the cross tie.

PROVIDENCE GIRDER RAIL.

Figure No. 23 shows a cross section of a rail weighing 54 lbs. per yard, patented by Lodowick Brayton, President of the Union Railroad Company of Providence, R. I.

Figure No. 24 is an isometrical view of a joint, and Fig. No. 25 an isometrical view showing construction in a street when cross-ties are used.

The chair under the rail as shown in Fig. 24, is two feet in length, and it is recommended to place them 7½ feet apart on centres. The cross rods ¼" × 1½" deep, are put in each 5 feet. They have a nut inside and outside of each rail. At the rail joints two fish-plates are used 8" × ½" × 4½" each, secured by bolts with nuts as shown in Fig. 24.

The method of construction is simple and rapid. The rails are laid in trenches, dug along the proposed line; tie-rods are then inserted, and chairs keyed to the rails. Small blocks of wood (say 2' × 4" × 6") are put under the rails at proper intervals, and the track is lined and surfaced on them, as with cross-ties. An excavation is then made under each

view, if the street traffic be very heavy, granite is more expense than steel or iron, as paving.

On my main line, granite blocks next to the rail were worn down ½ in. in two years, and had it not been for the tramway, the wear would have been greater; for the bulk of the travel is on the tram of the rail.

I am indebted to Mr. D. F. Longstreet, Vice President and General Manager of the Union R. R. Co., of Providence, R. I., for the drawings, etc., pertaining to this rail.

GIBBONS METALLIC STREET RAILWAY TRACKS.

The accompanying Figure, No. 26, shows an isometrical view of this construction. Figure 1 represents a cast-iron box, the top of which equals in width the rail, the bottom is wider. There is a continuous slot along the top, to permit the entrance of a projecting bottom flange of the rail, the top surface of which is similar to an ordinary centre-bearing rail, Figure 2.

These boxes are laid in trenches. T shaped mortises in their sides permit the insertion of tie-rods, which pass through the lower projection of the rail, as shown at 4. They are then keyed, to hold the track to gauge.

The batter given to the side of these cast-iron supports interferes with any paving unless the latter is dressed to the same inclination, for it would touch at the bottom, leaving an opening at the top. A better construction would be to

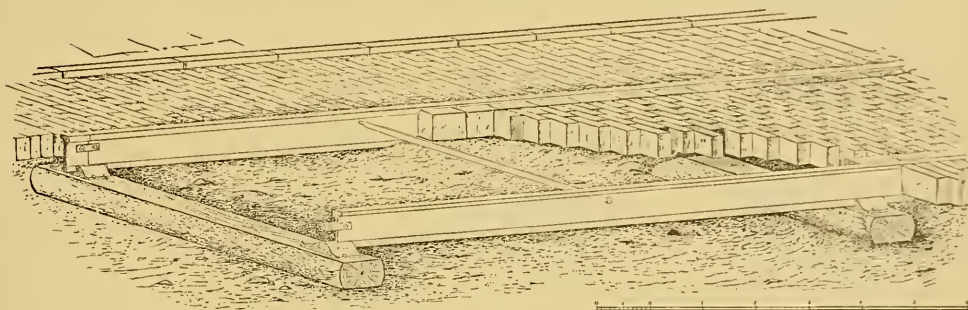

Fig. 25.

suspended chair to the required depth (6" to 8") and filled with a concrete composed by measure of 3 parts sand to 1 part cement, mixed with broken stone. A quick setting cement is used, so that two hours suffice for it to harden, when the blocks are knocked out and the weight carried upon the concrete. It is claimed that the process is simple and inexpensive, and the results very satisfactory; after severe cold, when the frost had penetrated four and five feet into the ground, numerous examinations were made but the concrete was found undisturbed.

As indicated in figure No. 25 wooden cross-ties can be used with suitable chairs, but the manager does not favor this plan, preferring to exclude all wood.

Seven miles of this track have been laid in Providence, and in 1886 it is expected that eight miles more will be put in.

As this rail has no tram, it is considered desirable, especially when laid to standard gauge, to put a course of granite on the inside of each rail, say 6" wide, and to put them on the same kind of cement foundation as the rails.

It is estimated that 125 barrels of cement suffice for one mile of track.

The balance of the paving is either granite or cobble according to the traffic in the street.

Clearance for the car-wheel flange is obtained by paving the horse path lower than the head of the rail.

It will be noticed that this rail has no tramway for ordinary vehicles. This construction is endorsed by the Mayor, City Engineer, Aldermen, etc., of Providence, and it is claimed that the rail is not so much of an obstruction in the street as a tram-rail. From a company's point of

widen the bottom below the pavement. The projection upon the bottom of the rail, and in fact the general idea of this construction is quite similar to that designed by W. J. Cockburn-Muir, and patented in England in 1870, and adopted for all the tramways at Monte Video. It was also used at Buenos Ayres, Salto and Bahia, Vienna, Palermo. In his system these cast iron boxes are turned upside down, filled with gravel or coarse sand, and closed with a hand-board. Then returned into place, when the board is slipped out. They are laid upon the ground, or upon a prepared bed of concrete. (See D. K. Clark. "Tramways.")

It is an admirable construction, and Mr. Clark states: "After having been down in Buenos Ayres upwards of ten years, Mr. Cockburn-Muir's way has stood well, and has given great satisfaction."

Mr. Gibbon in answer to my questions wrote to me January, 7, 1886, from Albany, N. Y.: "I have laid about 1½ miles of track in this vicinity, since Dec. 6, at intervals (between frosts) and which is now open, and well patronized by the people.

Our system is very simple. When the trenches are dug, the track is rapidly and accurately laid, for you will observe the web of the rail, compels the stringer to be in line; otherwise the web would not go into the girder. When in, the combination has enormous strength against lateral thrust.

The rail flange has an even and uniform bearing on the stringers, and the web of the rail is a very stiff girder for vertical stiffness.

The tie rod is notched, or shouldered, so that when the

notch fits in the mortises, inside of box, not only ties them together, but is a true track gauge also.

I would not hesitate to say that in seasonable weather, with 24 men, and trenches dug I would lay upwards of $\frac{1}{4}$ mile of track, levelled up and ready for pavers.

The men would be classed as follows:

- 4 men placing stringers, fixing tie rods, 2 in each trench.
- 4 men filling stringers with sand and tamping.
- 6 men placing rails in stringers.
- 2 men driving wedge keys through mortises in rail and stringers.
- 8 men levelling and surfacing ready for pavers.

IX.

TRACK LAYING.

In the majority of instances the municipal authorities require the tracks to be laid so as to conform accurately to the established grades, if the street be improved; if not, to be level with the adjoining surface. Street railway companies will find it advantageous to have a competent engineer to set grade and center stakes. My practice is as follows:

Having obtained the heights of grades established by act of common council and line of street, I have 3 strong oak stakes, two inches square, driven each 50 lin. ft. Two are for grade line. Their tops are driven to exact grade.

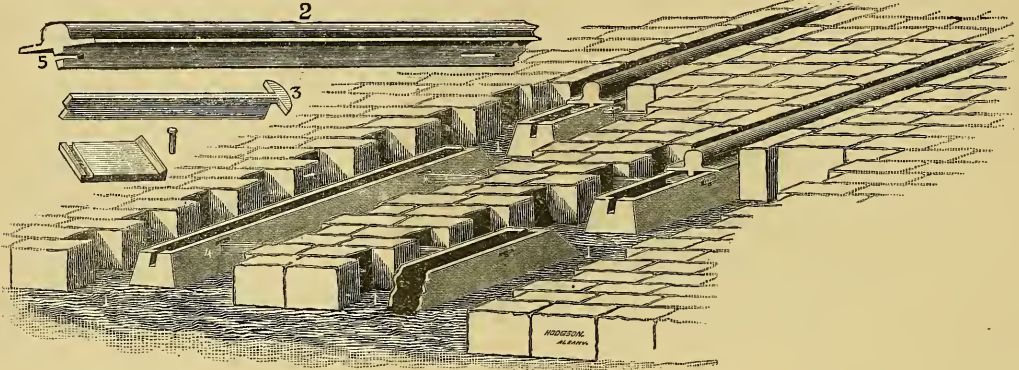

FIG. 26.

One for the center of track, and the precise point is indicated by a small tack. A gang of men under a sub-foreman excavate trenches for the cross ties, he measuring with a pole 16 feet long and marking each four lineal feet. He is careful to excavate deep enough, measuring from a line which is tightly stretched from stake to stake. It is easy to raise a tie, but a work of time and expense to lower one, after stringers and rails are placed upon it. Another gang of men carry and place the stringers upon the cross-ties, and rails upon the stringers, being very careful never to have two stringer joints (one on each side of the track) come upon the same cross-tie, and never to have a rail joint over a stringer joint; our limit is four feet stringer joints, and rail joints must all break at least four feet, and this brings them over another cross-tie. A carpenter cuts into the stringer at the end of the rail for the joint chair, which, as above stated, is with us, eighteen inches long. He is careful to adz the surface, so that it exactly fits the bottom of the chair, and the latter bears its entire surface. He allows the chair to project one-eighth of an inch above the stringer, so that when forced into the wood by the heavily loaded street-car wheel, it will be level, as our chairs are $1\frac{1}{2}$ inch deep, unless they happen to come just over a cross-tie, which should be the case about half the time, we insert, under the stringer, a strip of pine, $2'' \times 5'' \times 5''$, to get as much timber at the rail joint, as the balance of the track. The rail possesses no vertical strength, and will not carry our loads over an opening of 18 inches without deflecting, as we find to be the case over sewer manholes.

A proper allowance is made in leaving the joints open to permit expansion; but even during the hottest weather, I allow one-eighth of an inch, as the metal in the rail "flows" under the traffic, when it is all in one direction, as upon double track roads. The ends of the rails are examined, and all not cut square across, are rejected. If these were accepted when a proper allowance has been made at the projecting end, the rail being 5 inches wide, the opening would be increased too much at the other side. The rails having been spiked, alternate holes, with countersunk head spikes, $\frac{1}{2} \times \frac{1}{2} \times 5$ in., another foreman places a straight edge upon the top of the stakes at each end of a fifty feet; or more frequently, if the grade should not be uniform for fifty feet. He then puts his eye level with one straight edge and sights across to the other on the line of each rail, first one side, then the other, and has the track raised to exact grade and lightly tamped at the ends of the cross-ties, at the stakes, and at all stringer joints. The gang then raise all the other ties up to the bottom of the stringers, tamping first at the ends, and then under the centres. Particular attention should be paid to the tamping, unless this is well and solidly done, your track must settle and get out of surface. Upon a steam railroad, so soon as the track is laid, section men are put to work and begin leveling up the track, and so continue to do year after year. Your street railroad

track is put down to remain 10 or 20 years, with no opportunity to surface it up in paved streets. The ties having been well and securely tamped, another gang follow putting on the knees, two outside and two inside, upon each cross-tie. We use a Huntington gauge, which is always held at right angles. With the old-fashioned gauge, a careless workman might get it out of square, and the track would then be narrow gauge, resulting in derailment of cars or broken axles. The exact centre of our gauge is marked. The centre of the cross-ties is marked with chalk, and they are laid to line. Before the carpenter spikes on the knees, he goes to a centre stake and holding the centre of the gauge over the track moves the stringer to the gauge. Having done this at each end of the 50 feet length, he sights along one rail and his helper fastens it to line. They then nail all the knees along that rail inside and outside, and return along the other rail, placing it to tight gauge; very little other lining is required to make the track perfectly straight. The stringers between the cross-ties are then securely tamped.

Where my tracks are laid in unpaved streets, I nail a bracket upon each cross-tie, outside of the stringer. It is 3 inches thick, next to the stringer it comes within 2 inches of the top of the rail; and inclines from the rail 4 inches in one foot. Upon these brackets, oak plank 2 inches thick and about 12 inches wide are spiked. Vehicles can then cross the track at all points, and get onto the rails; and dangerous ruts are prevented adjacent to, and along side of the tracks.

[To be continued.]

RECENT DESIGNS IN SUMMER CARS.

Messrs. J. G. Brill & Co., Philadelphia, send us engravings of some recent summer cars, which contain various novel features. We present them with the descriptions and comments of the makers.

No. 210 is an open car seating 50 persons. The seats are arranged vis-a-vis, and there are sash and blinds in the centers of the end seats. The sides have curtains, arranged in sections and reaching to the sills. There is a "Monitor" deck roof with movable ventilators, and destination lettering in the centers and ends. The ceilings are of decorated veneer, and the cars have palace car finish throughout, bronze trimmings, and all of the makers' latest improvements. Fifty cars of this class have been furnished to the De Kalb Avenue Railroad of Brooklyn. The length of car over platform is 25 feet 4 inches; width over seat, 7 feet 6 inches; weight, 4,700 pounds.

No. 234 is a one-horse open car, having a length of body of 13 feet 6 in.; width, 7 feet 6 inches. The seats are arranged vis-a-vis for 24 persons. An aisle runs through the center connecting the platforms. It has enclosed ends, with sash and doors as in the ordinary closed car, and is paneled on the sides to the waist rail. The curtains on the sides are arranged to draw up on rollers. The car is furnished with patent "Equalizing Gear," patented brake shoes, patented brake, corner irons, braces and stays, and has horse guards. The trimmings are of bronze. Bell pulls are arranged on the sides within easy reach of passengers. This car can be made for operation with two fare boxes, or one movable fare box. The same pattern of car is furnished with enclosed front platform, and step or open platform in the rear, with stationary seats facing to the front end; and cars of this same pattern are built for operation with two horses, and having a seating capacity for thirty-two people. The length of car body in the latter case is 18 feet. The makers have recently furnished the Rochester City & Brighton Railway with six cars of this class.

No. 256 is a one-horse open car with a seating capacity for 20 persons. It is arranged with patent panels, foot rests,

rounded levers for the backs of seats, which are reversible, and driver boxes. It has curtains on the sides and ends, and head lights on the roof. Weight of car, 2,750 pounds.

No. 238 is an open car with open ends, having a total length over platforms of 24 feet, and a width across seats of 7 feet 3 inches.

The backs are high and reversible, and the seats are wide, with rounded seat back levers, arranged so as to prevent accidents in turning. Gum cushions are provided on the edge of the backs, so as to prevent them being bruised or broken. There are grab handles on the ends of the seats. They are fitted with a newly patented metal panel. In the ordinary cars these panels are made of 3/8-inch poplar, bent to shape, concave and convex, and fastened to a frame work, which is boxed into the post by gaining out from 1/2 to 3/4 of an inch, and are fastened to sill. This gaining of the post necessarily weakens it, to overcome which the posts are made larger, which of course increases the width of the car and also provides a place for the collection of water to rot the wood. They are the most vulnerable part of the car, easily becoming checked and broken, and with companies that have not good shop facilities, they are hard to repair, and are expensive. The metal panel overcomes these objections, never wearing out, and also lighting the car. There are foot rests on either side of the seats, and driver boxes under the front ends of the rear seats. They are furnished with patented "Equalizing Gear," patented brakes, and patented brake shoes, and have patented destination signs for both the sides and the ends, which are reversible. These signs are made so that when they are pushed up they will reverse back into position, and can be made to show two, three or four sides. The curtains on the sides and ends reach to the sills, and there are lambrequins on the insides. Two end lamps and one center lamp are provided. Rubber balls are fitted to the brake shafts, to prevent injury to horses. They have a seating capacity for 40 persons. Weight, 4,400 pounds. These cars are made in smaller sizes, to seat 35, 30, 25, 20, and 15 persons each.

No. 100 is designed for use in tropical countries, and is

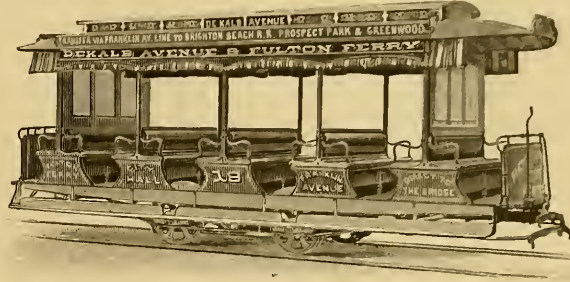

OPEN CAR No. 210.

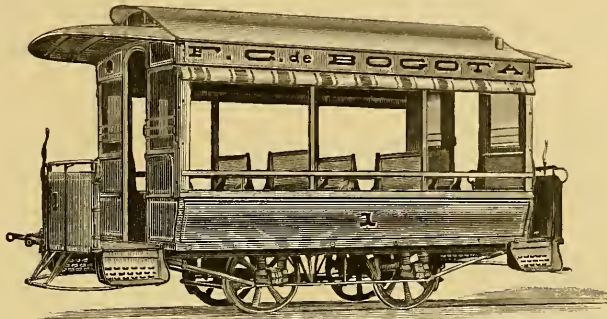

OPEN CAR No. 234.

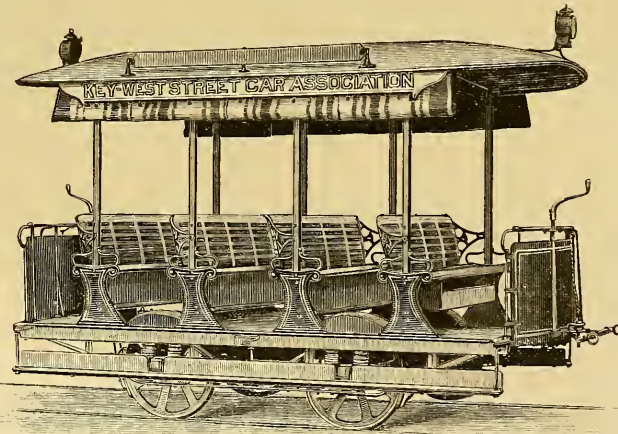

OPEN CAR No. 256.

intended for operation during the whole year. It has the "Monitor" roof, with ventilators in sides and ends extending the entire length of the car body. It has enclosed ends with blinds, and blinds also on sides arranged so that when not in use they can be slid up into the roof. The seats and backs are reversible, and the car has a seating capacity for thirty-five persons. The extreme length of the car is 24 feet; width at seat, 7 feet 6 inches; weight, 4,500 pounds. It is equipped with all of the makers' latest improvements, such as "Equalizing Gear," patented self-adjusting brakes, patented brake shoes, patented corner irons for platforms, and patented braces and stays.

A SANITARY VIEW OF RAPID TRANSIT.

In large cities the tendency is toward entire separation of the business and the residence districts. It is proper that this should be so, both for the convenience of transacting business and the comfort and health of residents. As a city grows in size and importance the distance between the homes and the offices of its business men increases in a greater ratio than the increase of the area occupied by business, and a large proportion of the adult male citizens must twice a day travel a considerable distance, too great generally to be traveled on foot by a busy man, who is either in haste to begin his work or fatigued after his day's labor.

In the case of all the larger cities, which are practically composed of a small business district and a very extended suburban residence district, comprising the municipalities and villages within a circle of fifteen or twenty miles radius, the health and comfort of a large proportion of the population are materially affected by the condition of the facilities for travel, as under the most favorable circumstances a great majority of the male and a large part of the female population must spend at least an hour and a half every day in some kind of conveyance between their homes and their working places.

The consideration of the sanitary condition of the vehicles in which so many persons are necessarily placed for a not inconsiderable proportion of their time, is worthy of the attention of engineers and others interested in the public health.

First of all, the passengers of a city or suburban road should be made comfortable. They have either just risen from their morning meal and are on their way to their day's work, or have completed their labor and are in a more or less fatigued state, on their way home. In either case, physical discomfort produced by being kept in a fatiguing position, in a draught, or in a close atmosphere, is a positive injury, tending to weaken the physical and mental powers more than hard work at the proper time can possibly do.

Next, the time of passage must be made as brief as possible, for travel to a laboring man is work, and time spent

in hurrying to the appointed daily task, or in reaching the rest of home after the task is done, is simply an addition to the hours of labor and a curtailment of the hours of rest.

Thirdly, the annoyance to residents along the routes of travel must be reduced to a minimum. The routes will necessarily be through closely populated districts for a considerable distance from the centres of business and population, and neither the lives nor the comfort of the residents should be endangered by possible contact with heavily laden, rapidly moving vehicles of transportation, or by their noise.

Fourthly, the cost of travel must be made small enough to attract travelers and yet large enough to properly remunerate the operators of the roads.

Both in theory and in practice the above requirements are fully attainable in only one way, and that is by making the road-bed on a substantially built structure which shall cross no street or road at its grade, shall traverse land devoted to no other purpose, and shall be provided with four tracks on which shall run commodious carriages, the motive power of which is concentrated at stations at long intervals, and which are lighted and warmed by methods which will not

not be liable to injure the passengers in case of accident to the vehicle.

On the other hand, it is certain that the requirements of rapid transit are not fulfilled by railroads on the surface of the ground, on which heavy motors, noisy in their operation, run at high speed. They are not fulfilled by passenger-cars heated by coal-stoves, and swept by a draught of cold air from a tilting transom over the end door. They are not fulfilled by iron trestles built over public streets and too flimsily constructed to carry motors of sufficient power to draw the necessary loads, and yet carrying machines which are so noisy in their operation as to be a frightful nuisance. Still less can the necessary condition of comfort and health be fulfilled by any subterranean structure. In London, where underground roads have been built and operated for several years, with all the efforts of the ablest men, theoretical and practical, to attain perfection, the testimony of the builders and managers of the roads is very strong to the effect that all their efforts to secure good ventilation have proved unsuccessful.

It is probable that by means of cables driven from central stations, as in Chicago, San Francisco, and Philadelphia, the noise of traffic can be largely reduced, and it is not unlikely that very soon electricity may be harnessed and made effective as a motive power, but good ventilation in tunnels is almost as difficult to accomplish now as it ever was.

We believe that the day is rapidly approaching when large cities will be traversed by viaducts, constructed on property exclusively dedicated to that purpose, and on which trains of cars will be propelled at high speed through the open air

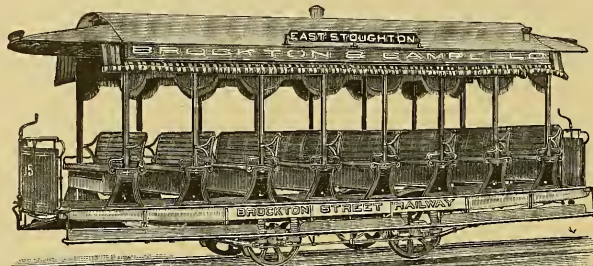

OPEN CAR No. 238.

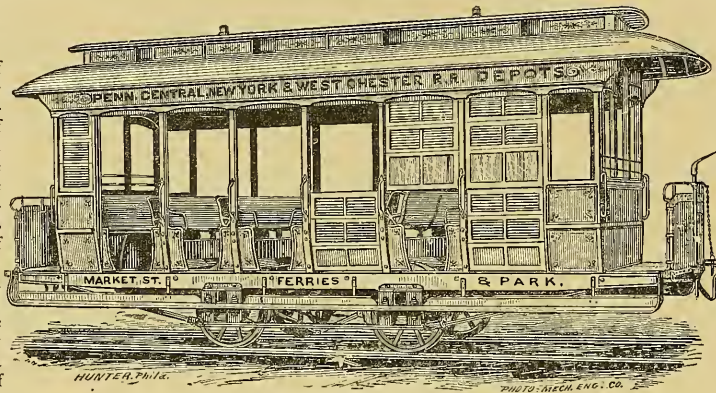

OPEN CAR No. 100.

by nearly noiseless motors, two tracks being devoted to long distance and two to short distance travel.

The cost of such structures will be large, no doubt, but if the city should furnish the right of way, as it ought to, the structures themselves and their maintenance and operation would cost less by at least thirty per cent. than if placed on a street already opened and built upon, and the damage to abutting owners would also be very much less. Even if the corporation building the road were compelled to purchase the right of way, it is held by many experienced men that the total cost would be less than for subterranean roads, and the cost of maintenance would be so much less and the facilities for operation in a satisfactory manner so much greater, that the investment would be profitable.

Examples of structures of this kind are in existence, and may be seen in Philadelphia on the Pennsylvania Railroad, in Newburg, N. Y., on the West Shore Railway, and in New York, in the section of the Suburban Rapid Transit Railway now in process of construction north of the Harlem River. We are convinced that the rapid transit of the future is to be attained on structures such as these, and not on "elevated roads," on streets, or in gloomy noisome tunnels.

What the advance of science may produce in the way of motive power is, of course, unknown, but in the present state of mechanical science the most probable solution of the problem of rapid transit for cities lies in elevated viaducts for trunk lines of fast travel, with compressed air or electric motors, cable tramways for lines concentrating at centres of transfer to the trunk lines, and horse or compressed-air tramways for collectors in outlying, sparsely settled districts. The health and safety of the public, which are the "supreme law," demand the prohibition of grade crossings where rapid motors run, and the keeping of the passengers above ground at any cost.

The Sanitary Engineer.

[We disagree with some of the conclusions reached by the writer of the above quoted article, especially those concerning the underground railways, in connection with which it is curious to note that, in speaking of the difficulties in ventilating the London railways, the conditions appear to have been overlooked. The task of removing the smoke given out from the soft coal furnaces of the many locomotives in these tunnels must be a vast one for the engineers, but with a tunnel in which the motors used should emit no fumes—as electric or soda engines, or cables, the case would be entirely different, and, we think, comparatively easy of solution.—EDITORS.]

STREET-CORNER COLLOQUIES

BETWEEN A POLICEMAN, A CAR-DRIVER, AND A BEER PEDDLER, WITH INCIDENTAL DAMAGE.

A Blue Island avenue car was jogging along westward on Madison street, near La Salle, yesterday, when just before the crossing was reached a policeman raised his baton in front of a big beer-delivery wagon crawling along between the street-car track and the curbing. The sleepy German on the elevated seat started suddenly as though awakened out of a nap, and, grabbing the reins, gave them a jerk that threw his horses almost upon their haunches, while the reverse action jammed the rear end of the wagon into the front of the street-car, smashing a window-glass and frightening the passengers nearly to death. The driver whirled his break around until it stuck fast, and then looked up at his beer driver, who seemed wholly overpowered by the gravity of the situation.

"You matton-head," he yelled, with just a tinge of annoyance in his tones, "what are you trying to do, any way?"

"Hey—vat—vell, I vas yust——"

"Go on now, I don't want none of yer back talk. Come down 'ere and pay for this 'ere glass."

"Yah; I vill not. Aaf you don't go so vast mit your keer, you don't got your vindeer broke out; and it?"

"Well yer bet yer life yer'l pay for this winder," said the driver, as he wound his lines about the brake-handle and prepared to descend to terra firma.

"Hare now, hare now," interrupted the blue-coated

guardian of the peace who had been the indirect means of all the trouble, "move on wid yez now. Yez can't be after blockin' opp the pooblic hoighway."

"Yah, what's der matter wid you," said the car-driver as he paused irresolutely upon the step.

"It mahkes no madder phat's the matter wid me; you take that ice-cooler av yoors along to the West Side. Come, Dutchey, you be afther moovin' at the same time."

"Vell, yah's der matter mit me. I go mit de stashun-house out aaf you vant me."

"I doan't want yez, ye lobster-faced tub ye. Don't yez see yez air blockin' the strate? Move on here, will yez?" And the policeman made a grab for the horses' heads, which made them rear backward and jam the end of the beer-wagon with another crash into the unoffending street-car.

The car-driver fairly glared about him, and then commenced to color the atmosphere with his choices expletives.

"Yer red-headed Christmas-gift yer," he howled at the policeman, "there's *one* winder yer bet yer life yer'l pay for. Ain't yer got no sense left in that carrot o' yours?"

"Yah; dat's vat's the matter," echoed the German as he prepared to gather up his lines.

"Shut up, you puddin'-head, or I'll come up there——"

"Yah, I guss you will not. I youst"—but what the man was "youst" going to do he left unsaid, for the irate policeman had struck one of the beer wagon horses over the flank with his club, and when last seen the driver was crawling up on to his seat from down among the beer kegs, and wildly clutching at the lines that had fallen down over the foot-board.

"Yez think yez air damn funny, don't yez," said the policeman to the car-driver, "but if yez don't get that dry-goods box off av this coorner I'll take the whole av yez to Harrison strate."

"Yes, yer will, yer terrier," muttered the driver as he unwrapped his lines and prepared to loose the brake.

"That's jist phat Oi'll do wid yez," reiterated the policeman.

"When did yer get out?" shouted the driver as he started his car and the long procession behind him began to move; "if I had that mug o' yer's I'd jine the museum, I would. O, yer a fine lookin' curiosity to be wearin' a star, ain't yer?"

"Phat's that ye's sayin'?" said the officer, as he shook his club at the retreating driver.

"Rats, ye terrier; that's what I say," called the driver by way of a parting salute, as he started his horses on a trot, and the policeman turned his attention to a crowd of boot-blacks who stood grinning on the corner.

THE LADY PASSENGER.

An observer says that when a lady takes her seat in a street-car she rests her satchel on her knees, opens it and takes from it a handkerchief and closes the satchel. Suddenly she reopens it, takes from it her purse, again closes the satchel, opens the purse, takes from it a dime, then closes it and returns it to the satchel, which she again closes. As soon as she receives her change she reopens the satchel, takes out the purse, closes the satchel, opens the purse, drops in the coin, and after snapping her purse once more, opens the satchel and drops the purse into it, after which she sits back with a self-satisfied air and rides to her destination.—*Ex.*

WE devote the greater portion of our available space, this issue, to discussions of the labor question, first, because there is nothing like striking while the iron is hot; second, because the solution of this problem is at this time the most important work on hand, and last, but not least, having time and time again pointed out the dangers ahead, we can not refrain, if we would, from shouting, "Didn't I tell you so!"

A new cable road between Ishpeming and Marquette, Mich. has been projected. Those who claim to know say that certain Chicago capitalists are backing the concern, and have bought the old Grace Furnace yards and dock in the northern portion of Marquette, where the road would have a terminus.

THE
STREET RAILWAY GAZETTE

MAY, 1886.—MONTHLY, \$2.00 PER YEAR.

COPYRIGHTED MAY, 1886.

WRIGHT, MONROE & CO.,
PUBLISHERS.

GENERAL OFFICES:

NEW YORK, - - - - - 181 Broadway.
H. D. Cozens, - - - - - Business Manager.
T. P. Pemberton - - - - - Associate Editor.
CHICAGO, - - - - - 43 Lakeside Building.
P. G. Monroe, General Manager.
E. V. Cavell, Business Manager.

Augustine W. Wright, - - - - - }
Henry C Lockwood, - - - - - } Editors.
George B. Heckel, - - - - - }

BRANCH OFFICES.

Philadelphia, Pa., 105 N. 4th St., J. Waterkeyn, Manager.
Cincinnati, 175 Vine St., Frank Trainor, Manager.
Pittsburgh, Pa., James Longhran, Manager.
St. Louis, Mo., 709 Olive St., Frank W. F. Scholl, Manager.
Atlanta, Ga., Chamber of Commerce Bldg., Wm. Minnigerode, Mgr.
St. Paul, Minn., 558 Drake Block, V. R. Benham, Jr., Manager.
San Francisco, Cal., 322 Pine St., G. W. Fairchild, Manager.
New Orleans, La., J. P. Brady, Manager.

REAPING THE WHIRLWIND.

"As a man soweth, so shall he also reap," is a law as old as old mother Earth herself; unchangeable as the granite foundations upon which she has builded, and its stern application is now being felt by this people with scathing force. The scenes which have so recently disgraced Chicago and other western cities, caused their streets to flow with blood, and their fair names to become a reproach and example, are but a natural consequence, the harvest-home of a former seed-time. As from Achilles' wrath sprang "woes unnumbered," so from the germs planted by the Chicago street-car riots of last July grew the bloody crop which has just been reaped. The scenes and incidents of that outrage are not easily forgotten. The forcible resistance to the officers of the law; the deadly assaults upon the loyal employés; the placing of obstructions upon the tracks; the half-hearted work of a brave but trammelled police; the foul-mouthed belchings of blatant socialists and anarchists; the sympathy of the citizens with the rioters; the truckling of the press to the lawless; the temporizing of a great city's executive with a mob, and the final surrender of the company to its defiant and law-breaking employés, are all yet fresh in the minds of those who remember, and convey a stern lesson to those who think. Now, the good citizen, all alarm and indignation, wants to arm for law and order; then, he either openly applauded or, with hands folded behind him, serenely smiled. Now, the police shoot to kill; then, they did not even club to hurt. Now, the mayor disperses at rifle muzzle even lawful gatherings; then, he quietly allowed red communists to shout, kill, burn, destroy. Now, there is hurry and hot haste: the marshalling of the State's armed forces; business is paralyzed, commerce obstructed, and the whole community excited and alarmed, as if the unexpected had happened, forgetting that as a man soweth, so shall he reap; forgetting that mobs are dangerous, whether composed of honest toilers or black anarchists; forgetting that the good citizen who sympathized with those who built barricades on the city's streets aided and abetted the methods of the commune; forgetting, that when the mayor arbitrated between chartered rights and organized riot, he warned to life a viper; forgetting that when the community brought such pressure to bear upon the West Division R.R., that they were obliged to clasp hands with mob violence and brute force, they sowed the wind, the cyclone of which they have just reaped.

DAMAGES.

The air seems thick with the grievances of the laboring class. The attempt to redress alleged wrongs by strikes, must be confessed by all thoughtful men to be unscientific and wrong; unscientific, because the movement that now agitates the community is not based upon economical principles, and wrong, because it will soon bring chaos upon the country, if the law does not reassert itself. The interference with transportation alone has entailed unknown loss and misery on the very class to which the striker belongs. It is a loss of time to discuss the monstrous proposition that advocates the seizure of property, clogs the avenues of trade, boycotts tradesmen, and in other ways exercises the brute forces of nature, irrespective of justice and reason. But it may truthfully be claimed that arbitration has been proposed by the labor movement, in certain modified forms. In this connection it is desired to draw attention to a consideration that has not yet received as much notice as it deserves. Of course the grievances of the strikers are everywhere urged. They are the moving party. But has it occurred to the doughty Knights that there is another side to this great question? Are there not grievances against the strikers? In the submission of the issues, would the strikers be willing to agree to pay an award, if one should be obtained against him? If, upon investigation, it was found that the striker had caused the destruction of property, destroyed life, hindered the free movement of transportation, and brought want and suffering to large portions of the community, would he pay damages and give some guarantee for peaceful conduct in the future? Society is so organized that there are penalties and punishments, as well as rewards, resulting from our acts. A man who has lost sight of this fact is an anarchist. Words must not be minced; blows must not be withheld. The sooner these rioters are punished, the better it will be for that freedom that should always characterize the administration of free institutions. Let the men who have initiated the disruption of law and peaceful government, stop in their headlong course and consider, not only the injury they have brought about, but also estimate, if they can, the damages that have accrued to the other side. These persons must understand that they can not take any position in life, or commit any act without assuming its legal and moral obligations. Citizens do not always seem to realize that while the law protects them in all their rights and privileges, there exists an implied contract on their part to obey the law and respect its requirements. Notwithstanding the wild and incoherent teachings of a few, it ought to be born in mind that there still exists some difference between license and lawlessness and good democratic government.

ABSURD DEMANDS.

Some time ago there seemed to be a general opinion in the public mind of New York that the street railway employés of that city were overworked, and when the first strike occurred this prevailing sentiment did much to ensure the success of the movement. But the more recent events that have developed such absurd and ridiculous demands of strikers, which preceded the acts of anarchists and nihilists, have caused a more careful investigation of the whole subject as viewed from the standpoint of economical science. In other words, the people are educating themselves upon this most important question, and when the public mind becomes once agitated upon any subject that affects the welfare of the commonwealth, good must certainly follow. The terrible events of the last few weeks has set reason at work to formulate and to crystallize. The whole press of the country teems with letters, editorials, and arguments. We have studied and contemplated. We have become wiser. One of the remarkable effects of directing the general thought of the community to the position taken by the strikers is, that there has been a complete reversal of the first decision of the people. The fact is, that it has dawned upon the minds of thinking people that there are rights that belong to others than those who represent mere manual labor. The way that the last demands of the strikers in the tie-up of the

Third Avenue Surface Railway have been met, illustrated the statements that we have made. A committee representing the employés, who belong to a Protective Association, went to the office of the company and presented the following petition:

"The following conductors and drivers, namely, Frank Bradley, Charles Farrington, John Reid, Michael Kelly and William Griffin, all drivers, and William Bardwell and Charles James, conductors, be discharged from the service of the company for the following reasons: The five drivers for using antagonistic and insulting language and trying to break up the Knights of Labor in general; and they further say that the Knights of Labor are not fit to associate with them; Mr. Bardwell for saying that he would take out a car in case of a strike and the road was tied up; Charles James for giving away the secrets of the association to parties outside of the organization."

The directors of the company decided not to consent to the discharge of the men, who had served the company faithfully for many years. President Lyons said: "We might as well meet this now as at any other time." The result was, that, on the grounds already stated, a tie-up was ordered. For a long time it was very difficult to obtain drivers and conductors, but so strong was the public opinion against the unreasonable and unjust demands of the men that they were powerless to interfere with the running of the cars. The public had completely changed its mind on the subject of strikes. It simply discriminated between just and unreasonable demands.

THE ARCADE RAILWAY IN NEW YORK CITY.

Governor Hill has approved the Arcade Underground Railway bill, which provides for the construction of a more stupendous work than any of its kind ever projected in this or any other country. A four track railroad, over which rapid trains will pass, will be built in a subway under an iron roadway. The general appearance of the present street will remain the same, and all kinds of traffic wagons, carriages, surface cars and other vehicles will have the same facilities for travel as heretofore. The space from curb to curb will be excavated. On the two inner tracks express trains will run at thirty miles an hour. The route is from the battery up Broadway to the Harlem river, with a branch under Madison square running up Madison avenue. It is estimated that the completion of the road will occupy 5,000 men for five years.

One of the peculiar features of the underground road is that it will connect with the regular steam railways that center in New York, in such a way that a passenger, for instance, who wants to go to a down-town point, can remain in his car until he reaches Union square, the Postoffice, or the Battery. The road will be ventilated and lighted at every cross street. The lighting will be done by electricity. In fact, it is claimed that an electric motor has been found which will operate satisfactorily.

The company has been put under a very heavy guaranty. It is compelled to deposit \$3,000,000 to be forfeited in case the project is not pushed through in the specified time.

This bill has been continuously before the legislature for twenty years. It has passed one branch or the other fifteen times; it has passed both branches four times, and three times it has been vetoed by the governors—Hoffman, Cleveland and Hill. The most persistent opposition was made to this law. The pluck and energy of its promotors have at last produced this successful result.

It would be quite impossible at this time to refer to many of the objections which have been urged against this work. One was that the road could not, for many years to come, pay interest on the investment. On the other hand, those who are best informed on the subject say that there can be scarcely any doubt of the financial success of this great undertaking. The Broadway land owners, the merchants and the trades-people generally, had to be conciliated; but there were other great conflicting interests. The gas, steam, pneumatic tube and telegraph companies stood in the way,

and the vast interest of the great city itself seemed to be interfered with.

In the mean time the Arcade Company was engaged in making a complete and accurate survey of the route it was proposed to traverse. Every inch of soil or trend of rock was tested. The best engineers were employed for this purpose. General George B. McClellan gave some of the best days of his life to this work. It was he who answered the claims made by certain persons, that the buildings upon Broadway would be endangered by the construction of the underground road. It must be borne in mind that the tracks are not to approach within fourteen feet of buildings on either side of the street. There is full provision in the act for compensating the owners of private vaults under the sidewalks, and "No private property, property rights or interests, corporeal or incorporeal, including property, property rights and interest of owners of lands abutting on streets, avenues, or places occupied by the railway, shall be taken or invaded by the company, without due compensation; but the company may acquire the same by agreement." The bill also declares that the company shall be liable for any injury that shall result to adjoining property, and for all direct or indirect damages. In addition to the guaranties and liabilities that have been mentioned, the company is required to give a bond, in the sum of not less than \$2,000,000, with sufficient sureties to be approved by the mayor of New York, conditioned for the payment of all damages which either the city or any owner of property may sustain by reason of the construction of such railway.

For over twenty years Melville C. Smith has led the list of projectors of the Arcade system of transit, and upon the authority of the *Chicago Tribune* the following gentlemen may be ranked among the financial backers of the scheme: Levi P. Morton, of the firm of Morton & Bliss; Cornelius N. Bliss, merchant; George S. Coe, President of the American Exchange Bank; Charles S. Smith, merchant; Henry Sanford, Vice-President of the Adams Express Company; Adolphe de Bary, importer of wines, etc.; George Cecil, railroad director and merchant; Alfred H. Hoyt, produce merchant; Robert Sewell, of the firm of Sewell, Pierce & Sheldon; Arthur B. Claffin, merchant; John Claffin, merchant; D. H. Wickham, diamond merchant; John G. Meigs, capitalist; R. G. Dun, mercantile agency; B. F. Dunning, lawyer; William Windom, ex-Secretary United States Treasury; Jerome Fassier, of the Champion Mower and Reaper Company; Melville C. Smith, projector and President; James Gilfillan, ex-United States Treasurer; Robert Schell, President of the Bank of the Metropolis; H. P. McGraff, President of the Bowery Savings Bank; J. H. Watson, President of the Bank of Columbia; E. S. Mills, capitalist; Frank Tilford, of the firm of Park & Tilford; D. S. Robbins, merchant on Broadway; Theodore Rogers, of the Bank of the Metropolis.

The rapid growth of the city of New York demands that this road be immediately constructed, and we sincerely hope that the promise already made by the Arcade Company, to the effect that the workmen would be plying their tools at the Battery within sixty days, will be fulfilled.

A CONVICT.

Jaehne, the New York Alderman who has distinguished himself in making it so difficult to obtain a franchise to run a street railway on Broadway, has been found guilty of receiving a bribe to vote for the measure. Mayor Edson had vetoed the resolution, when the Board held a session with locked doors and passed over the vote. Mr. Sharp was thus mysteriously presented with the right to build the road, although several rival corporations were ready to pay the city several millions for the privilege.

This "boodle" Alderman is guilty of the meanest of all crimes—that of prostituting an office that should be held by men of respectability and honesty. With the conviction of a score of these "political bunners" it may be that hereafter it will not cost as much in New York, to secure a franchise of a road as it does to build and equip it.

"A NIGGER IN THE FENCE."

A portion of the Chicago press is devoting considerable space to the street railway management of that city, and is scoring the surface roads right and left, or rather south and west. Among other things they have instituted a N. S. N. F. (no seat, no fare organization), which is peddling out printed badges (at a nickel apiece), to be worn by the proud purchasers as an emblem of their resistance to tyranny, also all kinds of opposition is heralded and advocated, stage lines, elevated and under ground roads, no extension of old or granting of new franchises, etc., etc.

Now, allowing some leeway for the sensational efforts usually put forth by small and new dailies to increase their circulation, and adding a fair profit for the N. S. N. F. badge sales, it would seem, even at low advertising rates, like giving too much pork for a shilling. Another peculiar feature of the movement is that two of the great Chicago roads come in for almost all of the attention, while the third goes comparatively scot-free; hence the query, is there "a nigger in the fence?" Is some person or persons after blocks of West Division or Chicago City stock, and hence enacts the bear, or rather bug-a-boo, behind the throne? Chicago street railways, in common with others, have always come in for a fair share of press abuse. They expect it. It is just as natural for the average press writer, when hard up for a subject, to pitch into the street railways, as it was for the old "granger" to go out and "whack" his army mule when his wife downed him in an argument; but so much attention piled on all at once, with so little seeming cause, looks queer, looks suspicious, and has an imported flavor. Hence our surmise of "a nigger in the fence." Perhaps not. We do not know; but we have heard of such things before—down East; anyhow, we would not advise the holders of the above named stocks to sell at much below par just yet. Wait. Perhaps the N. S. N. F. crusade, instead of being a mighty uprising of an injured people, backed by a powerful and independent press, is just one of those ways that are dark and tricks that are vain, for which syndicates are peculiar.

OYER AND TERMINER.

It was a cold morning, and Superintendent Campbell felt himself in the humor to be particularly severe on the delinquents that day.

The first to enter the dread presence was a burly Irish driver, who had been "laid off" for beating his team.

The superintendent was writing when the offender entered, and did not look up at once. So that individual took off his frowsy fur cap, and ran his fingers a couple of times through his stiff red hair; then coughed to attract attention.

The superintendent glanced up quickly. "Aw, it's you, Donovan, is it?" "Weel, mon!"—then resumed his writing.

"Yis, sorr," said Donovan, taking a step nearer, "it's meself, bedad." Then he awaited developments.

"Weel!" said Mr. Campbell presently, still writing.

Donovan grew red in the face, and stepping up to the superintendent's desk drew from his overcoat pocket a slender cotton whip lash, and threw it on the desk exclaiming indignantly, "Yis, and there's the raison why oi wurr laid off!"

"Hoot, mon," cried the superintendent, "an' whaur's the club at the end o't?"

"Sure an' it wurr but a switch like yer anner's little finger," said Donovan, beginning to wilt. "Troth an' yez couldn't hurrt a harse wid the same. An it wurr a divil av a schnail's tame oi had."

"Ye suld 'a reported it, Donovan, an' ye might hae got anither. Hie awa' hame, lad, for three days, an' learn by heart the scripture that says 'a mercifu' mon is mercifu' tae his beastie.'"

Donovan replaced his cap, and went out glowering.

The next to enter was an old son of Erin, who had been driving for the company more than ten years. He had been "laid off" at his own request on account of a hurt back, and had been reported to the superintendent as spending his vacation in the neighboring saloons.

"Yez wanted to see me, Misther Kummell?" he asked, on entering.

"Yes, I wanted tae see ye, Dennis," replied the superintendent, laying down his pen and wheeling 'round. "Dennis, it's bad reports I hear o' ye, lad. Why dinna ye keep oot o' thae dram-shops? If ye're weel eno' tae sit around thae groggeries, I misdoubt ye'd be weel enouch tae wark. I'm fash't wi' ye, lad."

Dennis became excited, and throwing his wet cap down on the superintendent's desk, proceeded to offer ocular demonstration of the state of his back.

"Hoot, lad, I dinna want tae see ye'er back."

"But av yez don't believe it's sore, oi can show yez that it's not decaivin' oi am, Misther Kummell," cried Dennis, in an injured tone.

"It's no' that, Dennis; I believe ye, lad; but I'm wanting to keep ye oot o' trouble. Look ye, Dennis; you an' I ha' been wi' the company thegither nigh about ten year, an' we've warked hard for every dollar we've got; isna' that truth, Dennis?"

"Troth, we have, Misther Kummell, sure."

"Weel, then, lad, I dinna like t' see the meeserable salun-keepers gettin' their thievin' han's sae easily on the siller ye've warked sae hard an' weel tae earn."

"But wurn't it the dochtor himself that towld me to rub me back wid whiskey, Misther Kummell?" cried Dennis, exultantly.

"Then why didna' ye get it frae' the drug shop, Dennis?"

"Och, but it's a divil av a bad whiskey they kapes in the same, Misther Kummell," deprecatingly. "Sure, an' oi'd be laid aff, parmanitly, nder the sod, if oi'd be usin' that same thrash."

"Weel, lad, gae hame noo, an' coom around the morn's mornin', an' I'll gie ye an order to Mrs. Cawmell for a pint o' guid and Glenlivet for ye'r bock; an' ye may tak it tae her, an' ye'll fin' it the vera best; list, mine ye my words, if I hear of ye again i' salunes, oot ye gang, like the snoo' o' a cannel!"

Dennis took up his cap, and departed grumbling; and the Superintendent, after quietly brushing away the water left from the cap, set to work once more, at his writing.

He had scarcely got to the middle of a sentence, when a dapper young patent salesman intruded.

The Superintendent glanced up quickly and saw at last a chance to be severe.

"Weel, young mon!" resumed his pen.

"I want to show you a very unique and useful device I am introducing"—the drummer started off, briskly.

"I'm very beesy the noo."

"I will occupy but a moment of your time. Mr. Brown, of the Perkinsville Railway—"

"I hae nae time tae leuk at it," a little gruffer in tone.

"But it's a very valuable invention, and by using it you can save—"

"I want tae save time, the day. I tell ye, I'm beesy."

"But"—

"Leuk, ye, young mon, I've tauld ye three times I hae nae time tae talk wi' ye. Noo, there's the dure; close it ahint ye, in gangin' oot." Then Mr. Campbell turned grimly to his writing.

The drummer stammered, and stumbled to the door and passed out precipitately.

John Day, a conductor who had been sent for, presently entered and announced himself.

The superintendent looked at him a moment, searchingly, and then asked: "Ha' ye nad ye'er breakfast the morn, Jock Day?"

"Jock" was a very ordinary sample of a very common kind of tough. He replied, "Not yit, Mister Cawmel."

"Well, gae oot at once, sir, and get it an' then coom back here; I want tae deescharge ye, boot I don't like tae sen' ye awa' on an empty stomach."

John departed, crestfallen, and the superintendent set to work in earnest to finish the often interrupted writing.

PERSONALS.

JAMES A. RICHMOND.

James A. Richmond, President of the Broadway Surface Road, arrested April 13 on the charge of attempted bribery, was born in New York State about forty years ago. While still a boy he went to New York City and engaged in business there. In 1867 he ran for State Representative and was defeated, but in 1868 he ran again, this time successfully. In Albany he made the acquaintance of capitalists interested in street railways, and soon associated himself with them in business. He was elected President of the Twenty-third Street Railroad, and, becoming acquainted with Jacob Sharp, was made President of the Broadway Surface Road.

AUGUSTINE W. WRIGHT.

AUGUSTINE W. WRIGHT, Consulting Engineer. HENRY RAEDER, Architect and Engineer. Room 7, No. 185 Dearborn Street, CHICAGO, May 17, 1886.

Dear Sir:—I take this means of informing you, that after nearly eight years' service upon the North Chicago City Railway, preceded by twelve years' engineering practice, I have opened an office as Consulting Engineer to Street Railways in connection with Mr. Raeder. I am prepared to make plans for any street railway structure. Having designed and superintended the construction of twenty-five stables, car houses, etc., for the North Chicago City Railway, and inspected most of the structures built by others for the prominent street railway companies, I have no hesitation in assuring you complete satisfaction.

Mr. Raeder is an architect and engineer of experience.

We solicit correspondence with any company purposing building, and will take pleasure in furnishing satisfactory references upon application.

Yours truly,
AUGUSTINE WRIGHT,
Consulting Engineer.

LEO DAFT.

Mr. Leo Daft, of Greenville, N. J., well known from his connection with the movement of running trains by electricity on the Ninth Avenue Elevated Railroad in that city, has recently received a patent for an invention relating to electric motors. It relates more particularly to the means for reversing such motors, and has for its object an improved construction of the reversing mechanism or brush carriers, so that they may be readily and easily operated, and that the brushes shall bear upon the commutator when in use in such a manner as to secure the highest efficiency and the least wear at the points of contact. Arrangements are made also that they may be readily thrown out of contact with the commutator when desired.

MR. F. T. LERNERD.

Mr. F. T. Lerner, of Andrews & Clooney, who was in Chicago, en route for San Francisco, has been obliged to return to New York, on account of the death of Mr. Clooney, and his proposed trip to the far West has been indefinitely postponed.

MR. B. A. CLOONEY.

Mr. B. A. Clooney, of the firm of Andrews & Clooney, died on the evening of the 14th inst., at his residence in New York. Mr. Clooney has been identified with the above concern since its inception and is well and widely known in the trade. He was also a prominent member of the A. F. & A. M. THE STREET RAILWAY GAZETTE, in common with his many friends, mourn the loss of a good citizen, an upright man, and a beloved brother.

POINTERS.

ALABAMA.

Montgomery.

As mentioned in our last issue, the Capital City Street Railroad Co., on the 15th ult., commenced running its cars regularly by the Van Depoele electric system. Everything is reported as working to perfect satisfaction.

ARKANSAS.

Little Rock.

The following board of directors of the Little Rock Street Railway Co. has been elected for the ensuing year: President, T. G. Darragh; Secretary and Treasurer, F. C. Reid; Directors, James R. Milton, W. Kipufle, George Reichart.

CALIFORNIA.

Oakland.

The construction of five miles of cable road from Seventh street and Broadway, in Oakland, along San Pablo avenue, is furnishing work for many laborers. The contract has been awarded to the Pacific Rolling Mills Company, who will furnish all the necessary material. About 4,000 barrels of Portland cement are now stored at the terminus of the line in Oakland, and from 3,000 to 4,000 more will be required. The cement will be laid in a trench beneath steel yokes bent to support the chair on which the rails are to rest. Against each yoke will rest two braces, which are to be finally riveted in place, and between these will pass the grip. The arrangement is somewhat different from that of the Market-street cable road, but there are no marked alterations in the general plan. The "belt" system, which was to have been adopted, will give place to the old grip and cable arrangement, which has stood the test of time and is deemed to be less expensive than the proposed double cable with metal cross-bars, although the inventors claim that the "belt" plan is cheapest in the end, as there is no wear from grips. The cable will be run by a Corliss engine of 400 horse-power. There will be a duplicate engine on hand to be used in case of accident. Over 100,000 feet of lumber is now on the ground for use in building sheds.

San Francisco.

Thirty-five cars for the Hayes-street cable line in this city are now being manufactured at the railroad shops in Sacramento. They are to be of a pattern similar to the Market-street cable cars which have given great satisfaction in the matters of strength and convenience of handling at terminals. Seven of the new cars have been finished, and ten others are nearly ready for painting.

COLORADO.

Denver.

The first successful attempt at trial trips of the new cable car has been made in Denver over a portion of the track of the Denver Electric and Cable Railroad Company, on Fifteenth street. The car ran a considerable distance, and at the satisfactory rate of eight miles per hour. A dynamo 20 horse-power furnishes the motive power for the car. Quite a large number of prominent citizens took rides on the car. Professor S. H. Short, of the Denver University, has worked very hard to make his invention a success, and his efforts seem to be already reaping their reward. The company had hoped to get the cars running in six weeks or a month. The car which is now being used in making trial trips is shaped and fitted up very much like an ordinary street car, and is fully as handsome in its style and appointments as any street car in Denver. It was made by Woerber Brothers, of Denver. The dynamo and other machinery, which is located in a building near Fifteenth and Tremont streets, and which is used to propel the car, was made by F. M. Davis, of Denver, and all the plant and material used by the company will be of Denver manufacture. Ex-Governor John Evans, W. N. Byers, Rodney Curtis and other well-known Denver gentlemen are among the officials and directors of the new company.

GEORGIA.

Athens.

Our country friends when they come to Athens always take an excursion on the street cars. The other day an old granger dropped a 50-cent piece into the cash box and asked the driver for change. He was told that he only should have placed the exact change in the box, but when the car reached the office he (the driver) would have it opened and the money returned. "Oh,

never mind all that trouble," replied the countryman. "If you don't care, I'll just ride it all out," which he did. A negro this week dropped 25 cents in the box and rode it out.—Banner-Watchman.

DISTRICT OF COLUMBIA.

Washington.

On the 1st inst. the street railway companies on Pennsylvania avenue, Seventh and Fourteenth streets made a reduction of time to twelve hours per day. This order was made in February last. Each street car was decorated with flags, while the horses were caparisoned with national colors, and wreaths of flowers were hung around their necks. One grizzly old driver had covered his car with large national flags, and numerous strands of sleigh bells made unseasonable music. The reduction was made voluntarily, and without strike or trouble of any kind. The conductors and drivers on the avenue were engaged fifteen hours and fifty-five minutes per diem, those on Seventh street fourteen hours and fifty-eight minutes, the lay-over time on the former being three hours and forty-seven minutes, and on the latter four hours and eight minutes. On the Fourteenth street line the time of actual service was eleven hours and thirty minutes, the lay-over time being four hours and eleven minutes.

ILLINOIS.

Chicago.

Mr. C. B. Holmes, Superintendent of the South Side Street Railway Company, states that at the last regular monthly meeting of the Board of Directors of the company it was decided to extend the State-street cable system from Thirtieth street to Sixty-third street. A plant of machinery will be located near Fifty-second street, and will contain two engines of 500-horse-power each. Work on the main line will be commenced early in May, but the date of completion can not yet be definitely stated, although the cable cars will be in operation before cold weather begins. No contracts for material have yet been made, the company having a large quantity on hand with which to begin work. The entire cost of construction, it is estimated, will be about \$500,000.

For a long time past the Chicago Mail has kept up a ceaseless bid for cheap notoriety by a general attack upon the street railway companies of the city. Fault finding is the easiest thing in the world, and there is so much ignorance and unreasoning selfishness in the world that the most illogical of grumblers may be sure of a large following. Little need be said in defense of the Chicago railways to those who know anything about the matter. There are no better tracks in the country, and but few finer equipments, taking them all together; nor are there many more wide-awake and enterprising managers than those which govern the street railway system of this city. A specimen objection will suffice to indicate the status of the Mail's arguments, for they are all of the same order. The Mail claims that persons not provided with seats, should refuse to pay fare, and demands that the West Side Company should furnish more cars for the morning and evening rushes. The cars now run during these periods on half-minute headway, and it would be impossible for Madison street to contain any more; even as it is, the cars are long delayed between State and Halsted streets. The only improvement possible would be to lay tracks on other streets, which is not practicable at present. Our wish is that City Councils might pass an ordinance preventing the cars from carrying more passengers than their seating capacity will accommodate, and the grumblers would soon waken up to the fact that our method of allowing people to stand is preferable to the Parisian plan of making passengers secure numbers and await their turns for seats. Doubtless the Mail is making a noble effort in the interests of humanity—and its subscription list; but the pretext is too flimsy for more than a passing smile.

The 161 mechanics employed in the shops of the Chicago City Railway Company have extended a vote of thanks to, Messrs. C. B.

Holmes, the superintendent, and J. B. Wright, the master mechanic of the company, for their gentlemanly treatment and kind consideration of the requests for an eight hour day.

CAPTAIN BONFIELD TO A REPORTER.

"You men blame Mayor Harrison for last night's work, but the newspapers of Chicago, with but two exceptions, and notably the penny press, are to blame for the deaths of the men in the line of duty. The *Daily News* and the *Mail* have persistently and continually maligned the police, and especially have they made sport of the action of the police at the July riot. This is a part of the results of that kind of talk. And the *Tribune* and *Times* bore them good company. Only two papers in the city—the *Inter-Ocean* and the *Evening Journal*—stood up for law and order and sustained the police department in the discharge of its duties.

Mrs. Eleanor Pye has entered a suit for damages against the City Railway Company. The plaintiff claims that on Nov. 6, 1884, as she alighted from an Indiana avenue car at Twenty-third street her dress caught on a nail on the car step. Before she could disengage it the conductor gave the signal to start the car and Mrs. Pye was thrown down and dragged some distance, receiving physical injuries. The company claims that the mishap was caused by her stumbling.

A committee of the trackmen in the employ of the South Side Railway Company, waited upon Mr. C. B. Holmes, superintendent of the company, and asked for the adoption of the eight hour system in their work. Mr. Holmes treated them very courteously, and said that he would grant them their request, beginning Monday. The committee, composed of Pat Frawley, John Demphy and J. Mahony, expressed their sincere thanks to Mr. Holmes for the way he had received them, and said they would never forget him for it.

The officials of the North Chicago City Railway Company sent word to their employes that they preferred that the men should join the benefit association proposed to be instituted by the company rather than to form a union or join the Knights of Labor. This communication was not favorably received by the employes, and they formed the North Chicago City Railway Conductors and Drivers Assembly of the K. of L. One of the principal grievances is that the company employs men to run "trip" cars and keeps them on them for an indefinite time without allowing full pay. The men insist all employes should be allowed regular pay after being at work two weeks, and when one loses a car, that he shall not be compelled to commence again at the foot of the ladder and work his way up from \$1.50 per day.

The employes at the shops of the West Division Railway Company have asked the company for eight hours, which it is willing to concede, but the question of wages is being considered, the solution of which will probably be an agreement to give them an advance on the old schedule of about 10 per cent., and allow them to work as many hours as they please. That is, they will be paid by the hour, with an increase of about 10 per cent over what they have been receiving per hour heretofore. The men employed laying tracks on West Eighteenth street quit work on the 1st as a matter of policy, when one of the red flag processions was passing, but so far as the company could learn, they were entirely satisfied with their hours and pay. The men laying tracks on Division street worked through the day, and nothing was heard of any dissatisfaction among them.

The men employed in the car shops of the Chicago West Division Railway Company to the number of 250 struck on the 7th. They want eight hours a day and 15 per cent. advance.

The West Division company has granted the Blue Island avenue conductors and drivers a reduction in labor. They have been making seven trips a day. Hereafter they will make but six. This will be about eleven hours work.

Notice has been sent to all the street railway companies to sprinkle from curb to curb the roadways in which their tracks are located.

President Yerkes, of the North Chicago Railway, had formulated a plan for a benevolent association which provided for the care of the company's employes in case of sickness and enough to help provide for their families in case of death. The employes are to bear no portion of the expense of the association. It is really a gratuity from the company. In case of sickness the employe is to receive \$5 per week and the attendance of a physician employed by the company. In case of death his family is to receive \$400. A committee of the conductors and drivers, chosen by themselves, is to attend to the business of the association and also to the burial of any deceased member. The committee who waited on Mr. Yerkes were delighted with the plan. One of them remarked that "this beats all the benevolent associations he had ever heard of, for the usual method required that the members pay in a great deal and get very little out, while this was a one-sided affair entirely—the men paying nothing, but getting the benefits just the same as though they did."

Judge Shepherd on the 8th dissolved the temporary injunction in the case of Peter Schuttler against the Chicago Passenger Railway to prevent it from laying its tracks on West Adams street, between Desplaines and Centre avenue. The chief objection made by the complainant was that the company had not obtained the consent of the requisite number of property owners, but the Judge held that the petition presented to the Common Council when the company asked for permission to lay its tracks contained the signatures of parties representing 3,000 out of 5,000 feet frontage on Adams street, and hence was amply sufficient under the law. The injunction to prevent the company from laying its tracks was, therefore, dissolved.

The contemplated improvements of the West Division Co. include the running of short-line or "loop" cars between State street and Ashland avenue. Starting from Randolph and State these cars would run south on State to Madison, west to Ashland avenue, north to Randolph street, and east to the starting point. Commutation tickets good on this line for single trip between Randolph street and Ashland avenue may be sold at special reduced rates, probably thirty for \$1.

Rockford.

Last year the street railway company averaged 17 cents per day over expenses.

**

INDIANA.

Indianapolis.

The city is to have another street railroad.

Michigan City.

The street railroad company has been granted permission to build its road, and work has begun. It is expected the cars will be running in June.

**

LOUISIANA.

New Orleans.

The Canal and Claiborne Streets Railroad Co. has applied for an extension of its franchise, which will expire in May, 1887.

The Crescent City Railroad Company has elected the following Board of Directors for the current year: W. J. Behan, President; John R. Juden, Secretary; F. Roder, A. Marquez, T. Prudhomme, P. K. Thompson, N. D. Wallace, F. A. Behan.

**

MARYLAND.

Baltimore.

The contract for the ironwork for the elevated railroad has been let to Oliver Bros. & Phillips. C. J. Schultz will do the construction of three or four miles.

The cars of the Citizens' Line are carrying blue flags bearing each a red star. These ornaments are intended to denote that it is an absolute union line and union pay, and to show appreciation of the consideration of the employers in granting the request of the men, for which they feel under obligation.

The strike reported in our last issue, continued until the 22nd ult., when it was broken, and since which time all the lines have been running regularly.

MISSOURI.

St. Louis.

One of the lines in this city has in contemplation the introduction of electric lights in street cars. The battery which will supply the electricity will be placed under the seats.

Mr. Stanley, agent of the Bently-Knight Electric Company, has been in the city this week looking over the ground, with a view to the introduction of this company's electric motors here.

The Cable company has purchased steel rails this week for five miles of new track, for their Narrow Gauge road.

It is stated that "the grips used on the St. Louis cable street railway have been found lacking in holding power, and are all being overhauled." It seems to be the case with a number of grips, that they either slip or hold so well that the cable is seriously damaged.

The street railroad company has introduced a bill to the municipal authorities for power to build a cable road on Broadway; but will not build unless the street is reconstructed with good paving. The cost per mile for double track is estimated at \$140,000.

Kansas City.

The remarkable success of the first cable railway in Kansas City has resulted in the granting of franchises for new cable lines which will make the city conspicuous for its street railway facilities. Its topographical features make Kansas City the most appropriate place, perhaps, in the country for the highest development of the cable system

**

MASSACHUSETTS.

Boston.

The Lynn & Boston Horse Railway Company has obtained control of the Woburn Horse Railroad, and has made application to extend from Swampscott to Marblehead, thus proposing to belt from Boston to Lynn, to Marblehead, over to Salem, thence to Stoneham, to Woburn, through Medford, thence into Boston.

Gloucester.

Payson & Co., of Boston, have the contract for the street railway. The extension to Rocky Neck has been petitioned for.

Haverhill.

The Pentucket Street Railway Co. has been organized with a capital of \$40,000.

Holyoke.

The street railroad company has commenced work on its extension to the Highlands.

Lynn.

There is strong opposition to any steam railroad between here and Nahant.

**

MICHIGAN.

Grand Rapids.

The street railroad company has recently purchased thirty horses, and will purchase twelve open cars. It proposes to double track a portion of its line and build extensions.

A new street railroad is proposed.

East Grand Rapids.

The cable railroad scheme has been abandoned.

**

MISSISSIPPI.

Natchez.

The Bluff City Railroad Co. has increased its capital stock to \$10,000, and will erect a new building.

Vicksburg.

Work has been commenced on the street railroad.

**

NEBRASKA.

Huron.

Mr. F. L. Sheldon, of Lincoln, has the franchise for a street railroad, and arrangements will be made shortly for the construction of the road.

**

NEW YORK.

Binghamton.

The Court Street and East End Railroad Co. has been incorporated by C. M. Stone and others. Capital, \$20,000.

Brooklyn.

The Atlantic Avenue R. R. Co. will shortly build a line on Hicks street from Hamilton to Atlantic avenue. It is to be in operation by July. The company intends to operate its Vanderbilt avenue line on the cable system.

Fulton.

The Fulton and Oswego Falls Street Railroad Company is to be organized.

Glens Falls.

The Glens Falls, Sandy Hill and Fort Edward Street Railway Company has elected the following board of directors: Henry C. andall, President; Geo. W. Brayton, Vice President; H. McGonigal, Secretary and Treasurer; Directors, T. S. Coolidge, S. D. Kendrick, Chas H. Green and George Bradley.

New York City.

The Terminal Underground R. R. Co. proposes to build a tunnel from the City Hall to the Grand Central Depot, with branches. President, C. V. Sidel.

Rockaway.

A company has been formed to build a 16 mile elevated railroad from Far Rockaway to East New York and to use the Brooklyn Elevated R. R. Co's line thence to Fulton ferry. John D. Cheever, of Rockaway, is interested.

Sea Cliff.

The Sea Cliff Elevated R. R. Co. has been incorporated to build from the Sea Cliff station (Long Island R. R.) to the cliff. The line, which will be worked by cable, will be about 2½ miles long.

New York.

The New York board of railroad commissioners has submitted a report to the Senate on the earnings of the Third Avenue Street-Car Company of New York. The present company expended as the total cost of the road and equipment to 1885, \$4,704,716. The original stock was \$1,170,000; the total now is \$2,000,000, and the bonds \$2,500,000. Interest at 6 and 7 per cent, was paid on the bonds. The dividends from 1853 to 1872 ranged from 6 to 12 per centum, and from 1872 to 1885, from 8½ to 20, except one year, when a dividend of 25 per cent, was paid.

Amendments have been made in Albany to the bill of the Arcade Railway Company to build an underground railway in Broadway from the Bittery to Fifty-ninth street, and also from Madison Square along Madison avenue to the Grand Central Depot. The amendments, which was suggested by Governor Hill and accepted by the railway company, provide compensation to the city for the franchise that will be granted to the railroad corporation. The property owners along Broadway are to be repaid from an indemnity fund for any damage to their buildings.

Senator Murphy presented these amendments to the Senate. They were accepted without debate and the bill was passed by 24 to 2. The Assembly also concurred in the amendments and passed the bill, and it was again taken to the Governor.

"Mr. Stewart's opposition to a railroad cost Broadway many millions more than he offered for the franchise," said a prominent Broadway retail dealer. "He not only drove business up town and recognized the fact by following it to Tenth street, but he made an opening for the elevated railroads which did him incalculable injury. If he had lived he would before this have turned his residence at Thirty-fourth street into a dry-goods bazaar."

A writer in the *Tribune*, who is evidently a close observer, says:

"I have watched the efforts of various people for the last twenty years to keep a railway off Broadway. Such people exist to-day, but are actuated by very different motives from those of the original opponents. Of course everybody will remember the opposition of A. T. Stewart, who at one time offered a million, then two million dollars, for a franchise with a proviso that he would not be required to build a street railway on Broadway. He made this proviso solely because he thought it would ruin the business of the street. Of course such an error would never be admitted by Mr. Stewart. His heirs, however, have admitted it and advocated the

present road. Actual events have already demonstrated Mr. Stewart's error. The elevated railways sprang up and carried trade from every part of Broadway below Fourteenth street, and carried it on that part of Broadway above Fourteenth street, to much higher points uptown. The present Seventh Avenue and Broadway Railroad got into Broadway above Fourteenth street, solely because Broadway above that point was an out-of-the-way region at that time; but the fact of the railroad being there built that part of the city up. It injured lower Broadway to some extent. When the elevated railways were built on either side of Broadway, all that part of it below Fourteenth street naturally suffered in consequence. The previous opposition was natural. Men in those days did not believe in the extraordinary development of New York. Now they recognize it, and their opinions are changed. In a city of the peculiar conformation of New York—all length and no breadth—people are going to shop only where there are convenient means of reaching the localities. Men sleep every night above Central Park, but they do business around Wall Street, solely because of the convenience of reaching the two points of local compass—the north and south ends of New York.

Both sides of the questions concerning the Third Avenue strike in New York City are given in the reports made by the Railroad Commissioners, and published on the 29th ult. The document consists of a majority report signed by Commissioners Kernan and Rogers, and a minority report signed by Commissioner O'Donnell. The majority report gives the grievances of the strikers and the cause of the strike, as well as a defence of the company, and adds: "While fully justifying the company in firmly rejecting the demand made as to discharging men, the Board considers those representing the company prior to the strike to have been made hasty and unwisely inconsiderate in their treatment of the men and their grievances, and not to have discharged their important duties as well toward either the company or the public, as though they had coupled the rejection of the improper demands with coolness, deliberation and a manifest desire to be just in other respects. The Third Avenue Company seemed willing to precipitate a conflict upon the unjust demand presented rather than endeavor to compel its withdrawal by fairly and deliberately considering those matters that the men had a right to present. Had this course been followed the strike might not have been averted, but at least the company would have shared no responsibility for its coming. The demand made for the permanent discharge of men in the service of the company was, in the opinion of the Board, properly rejected. The right to hire and discharge its servants is commensurate with the public duties imposed upon a corporation and hence the ultimate decision of all questions relating to the hiring and discharging of men must be left, where the law places it, in the railroad management."

"A quasi-public corporation can not yield to the dictation of employes nor arbitrate upon this question because it can not by such a course relieve itself of one iota of its legal responsibility for its servants and their conduct. As a matter of good policy and justice, the company should have given the men a hearing, but a notice was posted to the effect that the company would give the discharged men no satisfaction. This was a harsh rule, but until the law is changed, the employes have no redress. Throughout its hearing and presence in New York the Board endeavored to urge these views upon those representing the employes and to cause them to withdraw their demand, either that certain men should be discharged or that the question of their discharge should be arbitrated. Had the employes withdrawn this demand at the beginning of the hearing, as was done in the end, the complication arising from the hiring of many new men would have been avoided and would not have been the only final obstacle to prevent a settlement.

"If the Board had been appealed to before the inauguration of the strike to investigate and

redress grievances, its experience abundantly proves that even from the standpoint of the employes, these grievances could generally have been justly remedied without inflicting upon an innocent public the wrongs and inconveniences incidental to a strike, and upon the employes the hardship and losses incident to a cessation of their work and upon corporations financial loss. The proper method would be for employes to present their grievances to the authorities of the railroad. If they are denied a hearing or meet with a refusal or an unreasonable denial, then they should present them to this Board. A full investigation presents issues clearly, corrects misunderstandings, cools passions and restores the sway of reason. Public opinion, under the light of such investigation, almost invariably compels the redress of just grievances. By hastily precipitating strikes which affect the public, laborers lose the public sympathy, which usually sustains them in all just demands."

Commissioner O'Donnell signs the minority report. He says the right of men to strike is unquestioned. Recent facts show that almost all the concessions made to labor have been brought about by strikes. The general strike was ordered under a misapprehension and was unjust, but in the case of the Third Avenue Road, public sentiment was in favor of the strike and the bearing of the strikers was proverbially admirable. That the road has not been operated as required by its charter is so manifest as to require no argument.

"According to all statements a body of skilled laborers stand ready to operate the road. The only reply is, in effect, that it will compel the road to pay more—that is, employ more hands. The matter of the want of good faith on the part of the road in keeping to the very letter the agreement made with their employes after the strike in March deserves severe condemnation. The grievances alleged, that the road did not pay the same rate of wages as was paid on the other roads in the city and that the hours of labor demanded of the men were in violation of the agreement made by the road in March, ought to have been arranged by the road long before the strike was precipitated. The increase of wages demanded appears in gross to have been about \$10 per day. The statement concerning the giving of undue prominence to the last of a list of some sixteen grievances hardly presents to the public all of the facts. All of the sixteen grievances were not presented to the Board of Directors, but only the last one, about discharging men, which was not defensible. One of the bitter complaints made by the committee before the Commission was that this one complaint alone was given to the public by the road for the purpose of exciting prejudice against the men, while the long list of real grievances was suppressed. Only after the examination by the Board were these grievances generally given to the public. This, to say the least, was unfair on the part of the road, the inevitable result being to provoke resistance, while the employes were smarting under the sense of this injustice."

LATELY the New York papers have been giving attention to the question of rapid conveyance of passengers in the city—a question which a year or two ago was supposed to have been solved by the adoption of the elevated roads. The weight of opinion seems to be now that the elevated system, which has so greatly injured property on the streets given up to it, is alter all insufficient for the public needs, and that the only entirely satisfactory arrangement will be the construction of tunnel roads under some of the great thoroughfares, with separate tracks for long and short-distance traffic, so that the trains making the longer runs need not be stopped for way passengers. As a matter of safety, it is contended that the underground roads will be much preferable to the elevated lines, while they will be equally free from interference with or from the surface travel. This subterranean scheme is likely to have a fair trial in New York soon, and the experiment will afford valuable knowledge to the people of other cities. We have not yet commenced the construction of elevated roads in Chicago, and it may be as well, when the inevitable day comes for determining upon some mode of rapid tran-

sit, to make the first experiment with subterranean lines. The proposed use of the tunnels for street-railroad tracks would be a fair starting-point for the system, which could be extended from the tunnels to the city limits under any of the leading thoroughfares.—*Chicago Sun.*

We give elsewhere the text of the demands made by the employes of the Third Avenue line on the company,—they were, briefly the discharge of seven men, against whom the principal grievances were that they were not Knights of Labor, and had ridiculed that order. The company promptly refused to discharge these men on any such pretext, and consequently, on the 16th ult., the entire force of drivers and conductors struck. Meanwhile, the company having advertised for men, employed a great many "green" hands, by whom the cars were run, under police protection. The next move of the strikers was to tie up all the lines in the city, with the exception of the Eighth and Ninth Avenue roads.

When questioned about it, the employes of the Dry Dock line stated that they left work because they were ordered to do so by the committee, and not because they had any grievances. Forty-second street line men stopped for the same reason; in fact the men on none of the lines with the exception of the Third Avenue line, had any complaints to make in regard to their hours or their pay. The general tie-up was ordered so as to force the Directors of the Third Avenue line to yield to the demands of the strikers. The men ordered out on a number of the lines felt very bitter over the action of the committee in stopping all the cars, and stated that "this general tie-up business is being run into the ground." On the same day a small riot was summarily nipped in the bud through the prompt action of the police.

The railroad commissioners spent an entire day in a series of conferences with the representatives of the Third Avenue road and the strikers' committee. The strikers presented, finally, a long list of demands, fixing the hours and pay of all the employes of the road in all its departments; obligating the company to take back all the strikers, and to discharge all employes who are obnoxious to the strikers. The company submitted a series of propositions, offering after the men should have returned to work, to submit the questions of hours and pay to arbitration, but positively refusing to discharge any of the men now employed, or to employ any more of the strikers than was necessary. These terms were not acceptable to the strikers, and all attempts to arbitrate the matter were abandoned.

The employes of the other lines, rebelling against their forced idleness, protested so strongly that the Empire Protective Association was compelled to recede from its extreme position, and all excepting the Third Avenue hands returned to work on the 21st. The cars of that company continued running under police protection, and the Grand Jury took up the cases of the Committee, indicting them for conspiracy and coercion. Meanwhile, the strikers began running free stages along the company's line.

Several efforts were made by outside parties, to bring about an amicable settlement, but all resulted in failure. Consequently at the date of our leaving New York (7th inst.) the cars of the company were still running under police protection. One of the Chicago dailies thus temperately reviews the affair,—

"The directors of the Third Avenue Railway Company, of New York, have met the emergency forced upon them by the existing strike of their employes with creditable firmness and spirit. The men have stopped work and 'tied up the line' in order to force a demand without the slightest basis in reason, justice, or equity. The sum and substance of what they ask is that the railway company shall surrender the control and management of its property into their hands. They do not have, nor pretend to have, any tangible grievance against the company. They have no complaint to make in regard to wages or hours of labor, or any of the rules or regulations under which they have been working. They have simply undertaken to dictate to the company whom it shall employ and whom it shall refuse to employ, and failing in that have

placed an embargo upon the operations of the line, subjecting the public to great loss and inconvenience, and depriving the owners of the railway of the use and profits of their property. The directors at their meeting yesterday resolved against making the slightest concessions to the demands of the strikers, and announced their determination to run their cars at all hazards. They have called upon the authorities for protection and support in the exercise of their rights, and have given notice that they will bring the whole power of the law to bear against all who may attempt to hinder or obstruct the operation of their railway. They have, furthermore, announced that they will not discharge any of their 'non-union' employes, and that they will not take back into their service any persons who have destroyed their property or who have incited others to do so. In this action the directors have simply performed a plain public duty. Any temporizing with demands so monstrous as those set up by their late employes would have amounted to a flagrant betrayal of their trust. Very much of the trouble now prevailing throughout the country is unquestionably due to the lack of backbone shown by the officers of corporations, and employers generally, in dealing with similar emergencies. The spirit of lawlessness which is abroad has been stimulated by the timid and vacillating policy pursued by many railway officials, manufacturers, and other employers of labor. Almost every concession which has been extorted by strikers and boycotters since the present disturbances began has been the signal for fresh demands, more outrageous than those which had preceded. The paramount necessity of the hour is firmness, pluck, and courage on the part of all whose interests are assailed by the existing conspiracy against law, order, and the rights of property. The directors of the Third Avenue railway of New York have taken the only proper course, and will be sustained in their position by an overwhelming popular sentiment."

**
OHIO.

Cincinnati.

The hostlers of the Consolidated Street Railroad Co. quit work at noon on the 7th inst. On the 5th a committee representing the hostlers of all the stables of the company waited upon Vice-President Clark and presented him with the following:

CINCINNATI, May 4, 1886.

To the Consolidated Street Railroad Company of Cincinnati.

Dear Sirs: We, the undersigned, do hereby notify the company of an advance of wages for the work we are doing at present, and no extra work.

First Motion—All hostlers, car-repairers, feed-mixers, night watchmen and feeders are included with a raise of wages to \$12 a week of seven days and no extra work, and the hay-cutters \$2 a day of ten hours.

Second Motion—Twelve horses for each man, and do his own changing.

Third Motion—We will give the company until twelve o'clock Thursday noon to decide what they will do for us.

Fourth Motion—This strike has nothing to do with discharging any of the employes.

On Thursday Mr. Clark handed the following to the committee, and in doing so stated that it was the ultimatum of the company:

May 6, 1886.

To the Stablesmen, Car-repairers, Feed-mixers Watchmen and Feeders of the Cincinnati Street Railroad Company:

This company, in considering your request for an increase of compensation, hereby proposes as a matter of compromise the following:

Hostlers to receive \$10.50 per week and to care for fourteen horses and do their own changing, and where extra work is done, such as shoveling grain and handling iron in bulk, extra compensation will be paid at same rate.

Car-repairers, feed-mixers, night watchmen and feeders, \$10 per week for the same labor as now employed.

Hay-cutters to receive \$10 per week for six days work of ten hours.

CINCINNATI STREET RAILROAD CO.
On the 7th the committee handed Mr. Clark the following, and added that if it was not accepted all the hostlers would strike at noon:

CINCINNATI, Ohio, May 7, 1886.

Dear Sir: The proposition that the company made will not be accepted by the men of the street-car stables. The hostlers want \$11 a week and fourteen horses, and no extra work, or a strike; and \$12 a week of seven days, and car-repairers, tenders, feed-mixers, night-watchmen are willing to take the same or strike. The hay-cutters are satisfied with \$10 a week, and the boys of the Brighton want John Meiers back on his stand, and the boys want the two men back at Eighth-street Division that would not take the hill boys' place back also, and that all the men on the committee to take their same places as before. BY THE COMMITTEE.

The hostlers have been receiving \$10 a week for seven days work, and the hay-cutters, of whom there are but three, \$9 a week for six days work.

As soon as the men had struck the Police Department was applied to and a detail of police furnished the car stables at Brighton. The company claims that not one of the strikers will be taken back. Several men have already been employed, and Mr. Clark is of the impression that in a few days he will have a force sufficient to care for the horses.

**

PENNSYLVANIA.

Philadelphia.

The Traction Company has started a new line, called, from the color of the cars, the "Blue Line." The cars run over the following route: Down Hancock street to Columbia avenue, to Franklin street, to Seventh street, to Market street, to Seventeenth street, to Chestnut street; thence along Chestnut street to Ninth street, to Spring Garden street, to Seventh street, to Thompson, to Front street, to Columbia avenue, to Howard street; thence to Lehigh avenue depot.

The conductors on the Fourth and Eighth streets, Girard Avenue and connecting lines have been furnished with a new style of uniform cap. It is made of dark straw, with a curved visor, two narrow gold bands about an inch apart, and gilt buttons at either side of the visor. It is very neat in appearance, but the men complain of its weight and closeness, and the fact that it affords no protection from the sun to the back of the head. The lines controlled by the Traction Company will issue the same kind to their employes in a few days.

The Lombard and South Railway Co., has been forbidden by the Fairmount Park Commission to extend its line on 35th street and Belmont avenue.

Waterford.

A street railroad is proposed. P. E. Judson is interested.

Pittsburgh.

The pinkeye or epizootic, which paralyzed the business of the country a few years ago, has broken out among the street car horses in this city. Probably one hundred horses are affected, but no fatalities have occurred. Owners of horses are doing all in their power to prevent the spread of the disease.

**

RHODE ISLAND.

Providence.

There is thought to be a good prospect for a surface electrical railroad in Providence. The charters of the horse railroads are drawn in such a way that the cars of other companies can be run over existing tracks.

**

WISCONSIN.

Appleton.

The Appleton Electric Street Railway Co. is constructing a line expressly adapted for the Van Depocle system. The motors will be run by water power; and the road is to be completed by June 25. The Pullman company is building the cars.

FOREIGN ITEMS.

BERLIN, GERMANY.—Building has commenced at the Gesundbrunnen in this city on the Wedding and Moabit tramway, which, when completed, will unite the extreme north and west of Berlin.

During the past year extensive experiments were made with electric cars on Berlin tramways, and a report has now been presented to the magistrates on the subject. According to this there is little prospect of the cars coming into use, since the equipment and the cost of maintenance would be much higher than at present.

GLASGOW, SCOTLAND.—The fourteen miles of street railway in Glasgow are owned by the city, and bring to the treasury a rental of \$76,000 annually. There is no uniform rate of fare, but a penny a mile is charged, with reduced rates morning and evening, when the working people travel. The original purpose of the tramway, in fact, was to enable workmen to inhabit the suburbs.

[PARIS, FRANCE.—In our last issue, we gave an extended account of the Paris tramway system. The following promises a remedy for some of the evils therein narrated.]

The tramway companies of the North and South may congratulate themselves on Monday's vote at the Hotel de Ville. It clinches the decision to buy out these companies. The purchase money will probably come to 14,000,000 francs. The necessary repairs and additions to rolling stock will impose an expenditure of 8,000,000 more.

The inhabitants of Paris may also be congratulated. At the Hotel de Ville it is held that outside what used to be the octroi line of barriers in the early years of the empire, any tramway company authorized by the city has a perfect right to run its vehicles. The annual tribute per mile which the companies of the North and South paid to the Compagnie Generale des Omnibus was large, and was the reason of their present financial embarrassments. Were it not for this they would have paid splendid dividends.

It is expected that the vote of the municipal Council will have the indirect effect of breaking down the monopoly of the Omnibus Company. Should this expectation be realized it will be a good thing for the Parisians. The Paris omnibus was well enough when Paris was relatively a small city. The Champs Elysees was the great artery of the fashionable world. The tide of west end life now flows in strong currents in the Boulevards De Malesherbes and Haussmann, the Avenue de Friedland, and the other great arterial ways branching from the Arch of Triumph. There are magnificent districts like Belgravia and Tyburnia, which formerly constituted the banlieue. The French capital has, as well as London, become a city of great distances, and the old-fashioned omnibuses with their circuitous routes are inadequate to the needs of the population.—*London Daily News.*

NOTES.

THE BROWNELL AND WIGHT CAR CO., are building, for the Union Railway Co., of St. Louis, a number of summer cars of a new style and design, which are said to be of superior finish and elegance.

THE MARSHALL FARE REGISTER CO., report orders from Mexico.

A NEW METALLIC STREET RAILWAY SYSTEM is the recent invention of a well known Cleveland (O.) supply man; the particulars of which will shortly appear in these columns.

H. K. PORTER & CO., are building, for a Colton, Cal., company, a narrow gauge (36 in.) street motor. Also report recent sales of two dummy engines to the N. Y. H. & B. Ry.

RAILROAD CAR CENTRE LAMPS.—The two car-lamps illustrated in this issue are made by Josephine D Smith, 350 and 352 Pearl street, N. Y., and are numbered, the single light, No. 8, and the double light No. 10, in the firm's illustrated catalogue. They are entirely new designs.

KAMSDEN'S CABLE GRIP.—The double grip illustrated elsewhere is under the management of Dr. E. C. Hine, 1834 Green street, Philadelphia, who will furnish any desired particulars.

METALLIC TIE.—A metallic cross tie for street railways, for which letters patent have been issued to Henry Howard, of Boston, Mass., is formed of channel iron and has its open side upmost to receive paving blocks. At its ends are arranged rail seats or clamps resting upon the vertical side flanges and provided with lugs extending down upon the outer sides of the flanges and secured thereto by transverse bolts passing through the same. The rail seat has a lip on one side which holds over the base flange of the rail and on the other side a flange inclined inwardly towards the side and top of the rail and extending nearly to the top of the same. Between this last named flange and the side of the rail a wedge is driven, thereby keeping the rail in place.

BEADLE & COURTNEY.—The Philadelphia office of the Railway Register Manufacturing Co., Beadle & Courtney, general agents, has been removed to 423 Walnut street.

IMPROVED SPIKE.—Andrew Barrows, Chicago, is the patentee of an improved spike. It is made of iron or other metal, and has its corners rabbeted with curved or angular recesses from just above the commencement of the taper, which terminates in the wedge-shaped point of the spike in such a manner as to leave on each edge of the spike a lance-shaped barb flanking a rib of metal down the middle of the spike on its front and rear sides. The object is to increase the holding power of the spike when driven. The recessed portion extends halfway to the head.

DAFT COMPANY.—The Daft Electric Power and Light Company, of Missouri recently filed articles of incorporation at Belleville, Ill. The capital stock of the company is \$300,000. The incorporators are Christian Peper, John Scullin,

C. O. Godfrey and E. C. Rice, of St. Louis; T. D. Ripley and H. G. Bond, of New York City, and K. W. Haskerswoot, of East Orange, N. Y. A branch office will be opened in East St. Louis.

THE OFFICIAL RAILWAY LIST.—We have received from the Railway Purchasing Agent Co., E. M. Lewis, manager, a copy of this valuable book for the present year. It is familiar to all railway men and indispensable to those who have dealings with the railways. Its list of officials are very complete, and corrected to date; and we should not wish to find ourselves without a copy on our desk.

THE BROWNELL & WIGHT CAR COMPANY turned out forty new bob tail cars for the Union street car line, of St. Louis, last month.

CAR BUILDING BOOM.—Car building seems to be pretty lively just now. It is reported that in about fifteen shop orders are booked for 11,000 cars with the prospect of 4,000 more very soon.

THE JOHNSON STEEL RAIL COMPANY, Johnstown, Pa., have sold 1,500 tons of rails in Kansas City, through their local agency.

NEW YORK.—The trial of Alderman Jaehne for accepting a bribe of \$20,000 from the New York Surface Railway Company was begun on the 10th inst. in New York. The accused is defended by three attorneys, who raised various technical points regarding the make-up of the jury, and took exceptions when overruled. Five jurors were secured.

WANTED; FOR SALE; EXCHANGE.

This department has been established as a medium of exchange and bureau of general information, for the convenience of those connected with street railway industries. Street Railway Companies wishing to dispose of or buy cars, appliances or stock, or having contracts to let, persons having vacancies to fill, or wishing situations, etc., etc., are invited to use this department without charge; being requested only to notify us when the object desired has been accomplished.

FOR SALE.—A number of second-hand "bob-tail" cars. Description and price will be furnished on application to "CLEVELAND," care STREET RAILWAY GAZETTE.

FOR SALE.—Four second-hand box cars, 12 feet, made by John Stephenson & Co., N. Y.; owned closed front platform; rear step and sliding door. Owner will repaint, stripe and letter to order, guarantee brakes, bearings in first class condition, and put in Johnson fare-boxes. All these cars are equipped with Baltimore wheels. Price, \$365, f.o.b. in Indianapolis, Ind. Address BOX CAR, care STREET RAILWAY GAZETTE.

ADJUSTABLE SHOES.—A correspondent wants to know where the adjustable shoes mentioned in our last issue are made. Will some of our New York or Philadelphia subscribers kindly inform us where those used in these cities are made, and oblige.—THE STREET RAILWAY GAZETTE

WANTED.—A Street Railway, in Nevada, Missouri. A liberal franchise will be given. For particulars, address "Nevada," care of this office.

WANTED: POSITION.—By a practical Street Railroad man of 10 years experience in the management of employees and office details. Also several years experience in handling money and tickets. Strictly temperate and can furnish best of references from past and present Street Railroad Officers and others. Age 43. Address, S. LAMBERT, 177 Bank St., Cincinnati, Ohio

HORSE and MAN.

Their Mutual Dependence and Duties.

By the Rev. J. G. Wood, M. A.

Author of "Homes without Hands," etc., with illustrations. Svo. extra cloth, \$2.50.

"Certainly he has written one of the most valuable books about the horse and his proper care that have ever been issued from the press, for it makes very explicit statements concerning conditions that most books of its class fail to treat with anything approaching fitness, while it antagonizes in the most direct and positive manner common practices of the stableman and blacksmith. Some idea of the scope and method of Mr. Wood's book and of his manner of handling his subject may be gained when we say that eleven of his seventeen chapters are devoted to the foot of the horse, its construction, its proper usage, and so on. Mr. Wood not only finds plenty to say about horses' feet and their treatment, but says it very entertainingly; indeed, the book is a remarkable one for its entertaining qualities. It is not only full of information and important suggestions, but it is most charmingly written."—*Philadelphia Evening Telegraph.*

For sale by all Booksellers, or will be sent by mail, postage prepaid, on receipt of the price by

J. B. LIPPINCOTT CO., Publishers,

715 and 717 Market St., Philadelphia.

C. A. PALTZER & CO.,

LUMBER

2598 Archer Avenue, CHICAGO.
Ash, Oak and other Hardwoods suitable for Car and Track Work.

WRITE FOR ESTIMATES.

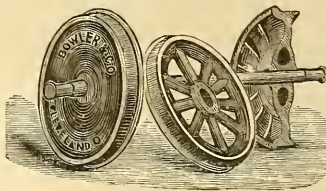

Car Wheels
OF ALL KINDS
FITTED TO AXLES.

Street Railroad Turnouts,
Transfer and Turntables,
Barn Drain Troughs and Furniture.
BOWLER & CO.,
14 Winter St., Cleveland, O.

Barnum & Richardson Man'g. Co.,
64 South Jefferson Street, **CHICAGO.**

CHILLED STREET CAR WHEELS
FROM PURE SALISBURY IRON.

Curves, Frogs, Switches, Crossings, Etc.
To Any Pattern.
Light and Heavy CASTINGS for all purposes.

W. H. BARNUM, ALBERT ALLING, WM. E. BEST,
Pres., Lime Rock, Conn. Gen. Mgr. & Treas., Chicago. Sec'y, Chicago.

O. W. MEYSENBERG & CO.,
WESTERN AGENTS

Johnson Steel Street Rail Co.

JOHNSON STEEL GIRDER RAIL
AND STEEL ROLLED CURVES,
Switches and Frogs, also Metallic Ties,

185 Dearborn Street, Adams Express Bldg., **CHICAGO.**

ST. LOUIS, 204 North 3d Street, Gay Building.

Chicago Malleable Iron Co.,
MANUFACTURER OF REFINED

Malleable Iron Castings,

Western Avenue & 26th Street,
CHICAGO.

❖ Street Railway Work to Pattern. ❖

Josephine D. Smith,
350 and 352 PEARL ST., NEW YORK,

Tin and Brass Box Lamps,
CHIMNEYS, BURNERS, ETC.

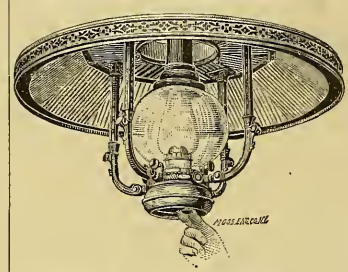

METAL CAR TRIMMINGS REFINISHED.
BRASS FINISHING.

Manufacturer of Railroad Car Center Lamps and Reflectors.

A. WHITNEY & SONS, CAR WHEEL WORKS ESTABLISHED, 1847.
PHILADELPHIA, PA.

Street Railway Wheels, Axles and Boxes.

Littell's Improved Track Scraper

CLEANS THE TRACK OF SNOW, ICE, MUD, SAND OR STONE.

CONTROLLED BY THE FOOT OF THE DRIVER.

ADDRESS, H. H. LITTELL, LOUISVILLE, KY.



IXL
LINIMENT
FOR
MAN AND BEAST.

For Sweeny, Poll-evil, Fistula of the Withers or Neck, Quittor, Broken or Sprained Knees, Knee-Sprung, Ring-bone, Spavin, Sprained Tendons, Shoulder Slip, Distemper, Lung Fever, Colic, Sprains, Bruises, etc., etc.

IT STANDS UNRIVALED.

Samples Free upon application.

D. ARNHEIM, 52 Second Avenue,
PITTSBURGH, PA.

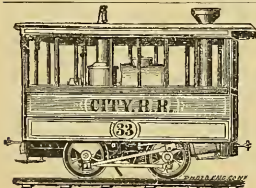

H. K. PORTER & CO.,
BUILDERS OF

Light Locomotives,

PITTSBURGH, PENNSYLVANIA.

Street Motors for City and Suburban Railroads, enclosed to resemble Street Cars, practically noiseless and smokeless. No Steam is noticeable under ordinary conditions of the atmosphere. These Motors are adapted to steep grades and sharp curves, and either Flat or Tce rails.

Illustrated Catalogue and Photographs mailed on application.

The Street Railway Gazette.

VOL. I.

CHICAGO

JUNE, 1886.

NEW YORK

No. 6.

WILLIAM WALLACE HANSCOM,
SAN FRANCISCO, CAL.

Mr. Hanscom, whose achievements as an engineer are familiar to the profession throughout the United States and England, was born at the town of Eliot, Maine, in 1839.

His early education was thorough, so far as it went, but though to-day he may be regarded as an exceptionally well-informed man, his knowledge is mostly that of his own acquiring, and he may be justly placed among the long list of "self-made" men which our country has produced.

Up to his twelfth year he attended the district schools of his country, and after leaving these, attended an academy, where he finished his schooling at the age of fifteen years.

At this time his parents removed to California and of course the son accompanied them. Here a happy combination of good fortune and his own predilections led him into mechanical pursuits, and in order to perfect himself in his chosen field of labor, he entered a shop and learned the trade of a machinist.

In 1861 the natural longing of a man to re-visit in maturer years the scenes and friends of his early youth and boyhood led him to make a trip "home"; and after spending a short time in renewing acquaintances and impressions he went to New York City, where during 1862, he worked as draughtsman for the Novelty Iron Works.

In 1863, thinking it about time to report in his adopted city, he returned to California, where he secured employment as draughtsman with the Golden State Iron Works, in which situation he remained for about three years. In 1866 he made his first personal venture, when, in company with others, he started in San Francisco, the *Ætna* Iron Works; with which establishment he was identified until 1875. At this date he sold out his interest in that concern, and went into the machine and foundry business, on his own account.

This enterprise he conducted successfully during the four years succeeding, until 1879, when he once more sold out, for the purpose of devoting himself to his chosen profession of mechanical engineering; and since the date mentioned until the present time he has continued in this busi-

ness both on his personal account and for three years as consulting engineer of the Presidio & Fervies Cable Railway Co., of San Francisco.

In 1882 Mr. Hanscom on invitation, went to London, where he designed and made the plans for the construction of the Highgate Hill Cable Tramway,—the first of the kind in Great Britain.

After finishing satisfactorily this engagement, he returned in 1883, to this country and to San Francisco, where he has since been continuously constructing and consulting engineer for the Clay Street Hill Cable Railway Co., the Cali-

formia Electric Light Co., and the Victoria Water Company.

His connection and experience with the Presidio Cable Railway Co. called his attention to the necessity of a brake for the car and dummy, which could be operated simultaneously by the engineer, without calling on the conductor for assistance in going over heavy grades, and the success of his test and experiments led him into the perfection and construction of a power brake for the steam cars of that road. His invention is being tested on one of the steam roads of the State, which has some of the most difficult grades in California. To this invention he is now devoting every moment he can possibly spare from his professional engagements.

During his 32 years of life as a machinist, mechanic, and engineer, Mr. Hanscom has been actively and frequently engaged in designing, constructing and operating many stationary and marine engines, as well as traction or road engines and machinery of various kinds for the generation and transmission of power and machinery for a great variety of manufacturing purposes.

He is an honorary member of San Francisco Section, No. 1, of California, of the National Association of Engineers, by whom he is held in the highest esteem. He was the first to introduce into England the method of running two cables in a single conduit, though, as usual credit, for the invention has since been given to an Englishman.

Mr. Hanscom has been married 24 years and has two children; a son, who following in his father's foot-steps is learning the machinist's trade, and a daughter, now attending the grammar school in San Francisco, where Mr. Hanscom continues to reside.



W. W. Hanscom

CONSTRUCTION, EQUIPMENT AND MAINTENANCE OF AMERICAN STREET RAILWAYS.

BY AUGUSTINE W. WRIGHT.

(Continued from page 136.)

The expense of track laying varies with the amount of excavation, kind and quality of material composing the surface of the street in which it is laid, etc., etc. For instance, in a very hard macadam roadway, two hours and a half have been consumed by a laborer in digging a tie hole, when fifteen minutes would suffice for sand. I have had to dig four feet deep in places, to put my tracks to grade, and at other points, fill up the street two and three feet. All these, and many other items, cause the expense of track laying to vary between wide extremes.

Mr. T. H. Gibbon, C. E., favors me with the following estimate:

COMPARATIVE FIRST COST OF STREET RAILWAY CONSTRUCTION.

| TIMBER SYSTEM. | | |
|---|---------|------------|
| Timber System. | Price. | Amount. |
| 66.83 Tons, 42 lbs. Rail..... | \$40 00 | \$2,675 20 |
| 352 Joint Plates..... | 50 | 176 00 |
| 6 Tons Knees..... | 50 00 | 300 00 |
| 3200 lbs. Spikes..... | 3 1/2 | 100 00 |
| 32 M ft. B. M. Pine Stringers..... | 23 00 | 736 00 |
| 700 Chestnut Ties..... | 35 | 245 00 |
| 700 Iron Tie Rods..... | 35 | 245 00 |
| 5250 Sq. Yards, Taking Up and Repaving..... | 15 | 792 00 |
| Hauling Material..... | | 150 00 |
| Hauling Sand..... | | 150 00 |
| Carpenters, and Track Laying..... | | 700 00 |
| Per Mile of Track..... | | \$6 269 20 |

Assuming the Life of Rail and Timber to be 20 Years.

| | | |
|--|-------|-------------|
| The Cost of Renewal would be..... | | \$ 6,269 20 |
| Taking Up and Moving Worthless Dirt..... | | 400 00 |
| | | 6,669 20 |
| Less 75 Tons Scrap Rail, etc..... | 20 00 | 1,500 00 |
| Cost of 1st Renewal..... | | 5,169 20 |
| Cost of 2nd Renewal..... | | 5,169 20 |
| Cost of Track at the Expiration of 40 Years..... | | \$16,607 60 |

GIBBON'S METALLIC SYSTEM.

| | Price. | Amount. |
|-------------------------------------|---------|------------|
| 66.88 Tons, 42 lbs. Steel Rail..... | \$40 00 | \$2,675 00 |
| Joint Plates, None Used..... | | |
| Knees, None Used..... | | |
| 2800 lbs. Wedge Keys..... | 2 1/2 | 160 80 |
| 50 Tons Metal Stringers..... | 45 00 | 2,250 00 |
| Chestnut Ties, None Used..... | | |
| 9000 lbs. Tie Rods..... | 2 1/2 | 225 00 |
| 2500 Sq. Yards Paving..... | 15 | 375 00 |
| 120 Tons Hauling Material..... | 1 00 | 120 00 |
| Hauling Sand..... | | 75 00 |
| Track Laying..... | | 500 00 |
| Per Mile of Track..... | | \$6,390 00 |

Assuming Life of Rail 20 Years. Cost of Renewal would be

| | | |
|--|---------|------------|
| 66.88 Tons Rail..... | \$40 00 | \$2,675 00 |
| 2800 lbs. Wedge Keys..... | | 160 00 |
| Taking Up and Repairing..... | | 300 00 |
| | | \$3,145 00 |
| Less 66 Tons Scrap..... | 20 00 | 1,320 00 |
| Cost of 1st Renewal..... | | \$1,825 00 |
| Cost of 2nd Renewal..... | | \$6,390 00 |
| Taking Up Old Material..... | | 200 00 |
| | | \$6,590 00 |
| Less Scrap Rails, Boxes, etc., 120 Tons..... | 20 00 | 2,400 00 |
| Cost of 2nd Renewal..... | | \$4,190 00 |

\$3,344.20, the difference in cost of 1st renewal at 4% interest for twenty years (the life of renewal)=\$7,439.84 less \$4,190.00, the amount of 2nd renewal—leaves the company a balance of \$3,249.84 and a new track; in other

words the amount saved in 1st renewal, \$3,344.20 creates funds sufficient for each future renewal, and also a balance of \$3,249.84.

The amount that will be saved in the track maintenance I cannot figure, but it is safe to say that at least 50% will be saved by the removal of articles which cause the repairs.

The estimate for the Gibbon metallic system is founded upon his experience in laying the same.

Space does not permit an estimate of his estimate of renewal.

The width of the street, and municipal legislation, usually fix the distance between tracks, when double tracks are laid. With a gauge of 4 ft. 8 1/2 inches, four feet between the tracks is a quite common allowance, but with present practice in building street cars, I prefer four and a half feet, as there is less danger of accident from passing cars.

When the street grade is level, I always incline my tracks towards the sewer-catch basin, one-tenth of a foot in each fifty lineal feet, to carry the water. It would be very difficult to maintain a pavement laid upon a dead level. The pavement outside of the railway tracks requires ditches at each curb to convey the water to the sewer inlet; and it is an advantage to give an inclination in the same direction, along the railway tracks. Otherwise, the cross section of the street will be so steep, next to the sewer inlet, that horses experience difficulty in maintaining a foothold.

The gauge of the street railway is generally fixed by law. Four feet eight and one-half inches is the most usual. In smaller towns, three feet is used. It possesses the advantage that ordinary vehicles can not follow the rails. The disadvantages; that if they run one wheel upon the rail expensive ruts soon wear into the pavement, and the horse path is narrow for two horses of average size to travel therein.

The following tables will prove useful in estimating quantities.

RAILROAD IRON REQUIRED FOR ONE MILE OF TRACK.

| Weight per yard. | TONS | | | | Weight per yard. | TONS | | | |
|------------------|---------------|-------|---------------|-------|------------------|---------------|-------|---------------|-------|
| | Of 2,240 lbs. | | Of 2,000 lbs. | | | Of 2,240 lbs. | | Of 2,000 lbs. | |
| | Lbs. | Tons. | Lbs. | Tons. | | Lbs. | Tons. | Lbs. | Tons. |
| 8 | 12 | 1,280 | 14 | 160 | 52 | 81 | 1,600 | 91 | 1,040 |
| 12 | 18 | 1,920 | 21 | 240 | 56 | 88 | | 98 | 1,120 |
| 16 | 25 | 320 | 28 | 320 | 57 | 89 | 1,280 | 100 | 640 |
| 20 | 31 | 960 | 35 | 400 | 60 | 94 | 640 | 105 | 1,200 |
| 25 | 39 | 640 | 44 | | 62 | 100 | 1,280 | 112 | 1,280 |
| 28 | 44 | | 49 | 560 | 64 | 102 | | 114 | 800 |
| 30 | 47 | 320 | 52 | 1,600 | 65 | 107 | 320 | 119 | 1,360 |
| 35 | 55 | | 61 | 1,200 | 68 | 106 | 1,920 | 119 | 1,360 |
| 40 | 62 | 1,920 | 70 | 800 | 70 | 110 | | 123 | 400 |
| 45 | 70 | 1,600 | 79 | 400 | 72 | 113 | 320 | 126 | 1,440 |
| 48 | 75 | 960 | 84 | 960 | 76 | 119 | 960 | 133 | 1,520 |
| 50 | 78 | 1,280 | 88 | | | | | | |

NUMBER OF RAILS OR JOINTS IN ONE MILE OF SINGLE TRACK.

| Length of rail. | Number of joints. | Length of rail. | Number of joints. |
|-----------------|-------------------|-----------------|-------------------|
| | | | |
| 22 | 480 | 28 | 377 |
| 24 | 440 | 29 | 364 |
| 25 | 422 | 30 | 352 |
| 26 | 406 | | |

CROSS TIES PER MILE OF SINGLE TRACK.

| | |
|----------------------------------|-------------|
| 18 inches from center to center, | 3,520 ties. |
| 20 " " " " | 2,168 " " |
| 22 " " " " | 2,880 " " |
| 24 " " " " | 2,640 " " |
| 27 " " " " | 2,347 " " |
| 30 " " " " | 2,112 " " |
| 33 " " " " | 1,920 " " |
| 36 " " " " | 1,760 " " |
| 42 " " " " | 1,508 " " |
| 48 " " " " | 1,320 " " |
| 54 " " " " | 1,173 " " |
| 60 " " " " | 1,056 " " |
| 66 " " " " | 960 " " |
| 72 " " " " | 880 " " |

TABLE OF HOOK-HEADED RAILROAD SPIKES.—JONES & LAUGHLIN'S
PITTSBURGH, PA.

| Size measured under head. Inches. | Average No. per keg 150 lbs. | No. to lay one mile track four to a tie. Ties two feet from cen- ter to center. | | Rail used, weight per lineal yard. |
|--------------------------------------|------------------------------------|--|-------|--|
| | | Lbs. | Kegs. | |
| 5 1/2 x 9-16 | 280 | 5,670=38 | | 45 to 70 |
| 5 x 9-16 | 300 | 5,170=35 | | 40 to 56 |
| 4 1/2 x 1/2 | 400 | 3,960=27 | | 35 to 40 |
| 4 x 1/2 | 450 | 3,520=24 | } | 30 to 35 |
| 3 1/2 x 1/2 | 510 | 3,110=21 | | |
| 4 1/2 x 7-16 | 510 | 3,110=21 | } | 28 to 30 |
| 4 x 7-16 | 630 | 2,560=17 | | |
| 3 1/2 x 7-16 | 675 | 2,350=16 | } | 20 to 28 |
| 3 1/2 x 3/8 | 890 | 1,780=12 | | |
| 3 x 3/8 | 1,030 | 1,510=10 1-5 | } | 16 to 20 |
| 2 1/2 x 3/8 | 1,200 | 1,320=8 4-5 | | |
| 2 1/2 x 5-16 | 1,620 | 1,000=6 1-2 | | 8 |

NUMBER OF WROUGHT SPIKES TO KEG 150 POUNDS.—JONES & LAUGH-
LIN'S, PITTSBURGH, PA.

| Length. | 1/2 inch. | 5-16 inch. | 3/8 inch. | 7-16 inch. | 1/2 inch. |
|---------|-----------|------------|-----------|------------|-----------|
| 3 | 2,250 | --- | --- | --- | --- |
| 3 1/2 | 1,890 | 1,208 | --- | --- | --- |
| 4 | 1,650 | 1,135 | --- | --- | --- |
| 4 1/2 | 1,464 | 1,064 | --- | --- | --- |
| 5 | 1,380 | 930 | 742 | --- | --- |
| 6 | 1,292 | 868 | 570 | --- | --- |
| 7 | 1,161 | 662 | 482 | 445 | 306 |
| 8 | --- | 635 | 455 | 384 | 256 |
| 9 | --- | 573 | 424 | 300 | 240 |
| 10 | --- | --- | 391 | 270 | 222 |
| 11 | --- | --- | --- | 249 | 203 |
| 12 | --- | --- | --- | 236 | 180 |

STREET AND TRAMRAIL SPIKES, COUNTERSUNK HEADS.—JONES & LAUGH-
LIN'S, PITTSBURGH, PA.

| Size. | No. to keg of 150 pounds. | No. to lay one mile, the holes two feet apart. | |
|--------------|------------------------------|---|-------|
| | | Lbs. | Kegs. |
| 2 1/2 x 1/2 | 2,300 | 345=2 2/3 | |
| 2 1/2 x 5-16 | 1,720 | 565=3 3/4 | |
| 3 x 5-16 | 1,250 | 640=4 3/4 | |
| 3 1/2 x 5-16 | 1,150 | 690=4 3-5 | |
| 5 x 5-16 | 900 | 880=5 5/8 | |
| 6 x 5-16 | 840 | 940=6 1/2 | |
| 4 x 1/2 | 530 | 1,500=10 | |
| 4 1/2 x 1/2 | 480 | 1,650=11 | |
| 6 x 1/2 | 360 | 2,190=14 3/8 | |
| 6 x 9-16 | 270 | 2,930=19 1/2 | |

TRACK CONSTRUCTION IN SMALLER TOWNS.

In this country there are about one hundred and twenty-five street railways using a T rail, weighing from 15 to 56 pounds per lineal yard.

As a rule these tracks are not paved, and are an obstruction to a greater or less degree in the use of the street by the general public. They are cheaply laid and durable, when the traffic along them is confined to the street railway cars.

A block of wood should be inserted between the bottom of the rail and the cross tie, to get the latter deep enough to protect it from the wear of horses' hoofs and ordinary vehicles. Holes should be bored in these blocks, through which hook-headed spikes may be driven to fasten the rail to the cross-ties. The latter are spaced two to three feet between centers. Plank two inches thick of oak or pine, six to twelve inches wide, is frequently used on each, outside of the rail, to allow vehicles to cross. Blocks are sometimes fastened to the cross-tie to which these planks are spiked, so that their tops come a trifle below the rail head, or the plank rests on the bottom flange of the T rail, and is spiked to the tie.

Cedar fence posts, sawed in half, are sometimes used for cross-ties, the wide part put up, under the rail. Pine is also used, sawed 4" by 6" or 5" by 7" and 7" or 8" long.

Other roads use a light train rail, 4 or 5 inches wide, weighing from 16 to 30 lbs per lineal yard, placed on stringers, the top of which have been dressed to fit the bottom of the rail. These stringers correspond in width to the rail and are six or seven inches in depth, depending upon the pavement to be used. Sometimes they are secured to the cross-tie by boat spikes, passing through the stringer, and driven before the rail is put in place, or round iron 1/2 inch in diameter without head, is used. If it becomes necessary to remove a cross-tie, this construction is objectionable and a pin of hard wood is preferable.

Outside, the stringers are braced by brackets of pine, cut to pattern as before described, from plank 3 or 4 inches thick. These are spiked to the cross-tie and to the stringer, and upon them planks are fastened parallel to the rails, as above described.

I have no hesitation in recommending some type of the girder rail for all these roads where wooden stringers have been used heretofore, believing it will furnish a better track, and therefore deem further description of the present construction, superfluous.

CURVES.

The radius of the curve is usually regulated by the width of the street.

Forty-five feet radius upon the center line is quite common. When two curves occur, a double track leaving a double track, they should not be struck from the same center! For instance, suppose we make an inside curve of forty-five feet radius. If the tracks are nine feet apart on center lines, and we make the outer curve fifty-four feet radius, striking it from the same center; if two cars should meet at one end of the two curves, the car on the forty-five feet radius curve would project fourteen inches further from the track than ordinarily, and if four feet be assumed as a safe distance, it will be reduced to two feet and ten inches, with a liability of accident.

If forty-five feet be used as the radius of each curve, the outside curve will not begin until a point nine feet beyond the inside point of curve shall have been passed.

My own practice is to make the inside curve with the longest radius that the circumstances will permit, and make the outside curve with a radius that will not lessen the distance between the cars. After the two cars are both upon the curves, even if they are struck from the same center, the distance will be the same between them, as on the straight track.

Regarding steam railroads, Trautwine wrote:

"It is assumed that the total amount of extra power due to curvature, and expended in running around any given curve, at any given speed, is in proportion to the number of degrees contained in the curve, without regard to its radius or length."

Baron Von Weber considered "that resistance due to curve increases faster than radius diminishes."

Street Railway curves with guard rails upon outer and inner lines are quite different from the steam railway curves, in the amount and character of the resistance they offer.

The longer the radius, the less the wheels bind in the groove, while the resistance is spread over a greater length of track! Cars are not strained so much nor do horses have to pull so hard at a given instant. The grade of the curve had best be level, if possible, in street railway construction. The low speed obviates the necessity of elevating the outside rail.

Over one hundred companies use grooved, rolled rails for curves, and lay them to light gauge. The accompanying cuts, Nos. 16 and 17, show the form of such a rail. It is laid inside and outside of curves from 28 feet to 150 feet center radius. From 150 feet to 600 feet radius I use one such rail on the inside of the curve, as a guard and any ordinary rail outside.

In passing around a given curve the *front* wheels of the street car usually bear against the inside of the outer rail, the tendency being to travel at a tangent to the curve. The rear wheels bear against the inside of the inner rail. The guard rail, therefore, laid on the inner curve line prevents the front wheels leaving the track. It should be extended at least eight feet on the straight track. The guard rail on the outer curve line performs the same duty for the rear wheels.

The street car having a short wheel base, usually six feet, with ends overhanging often nine feet, is quite unstable and is easily deflected from the track, the wheel flange being often only one-half inch in depth. This liability to leave the track is increased by the fact that frequently the front or the rear platform is loaded more heavily than the other. If the greatest load is on the front platform, the rear wheels are liable to leave the track, or vice versa.

Many roads consider a guard rail as unnecessary with radii exceeding two hundred feet, preferring to take the chance of the cars running off the track! Accidents are expensive! In many of the states, if a person is *killed*, \$5,000 limits the liability, but in the event of serious injury, *ten times that amount* has been awarded by juries!

I, therefore, think it the part of wisdom to use guard rails, as a matter of insurance against accidents.

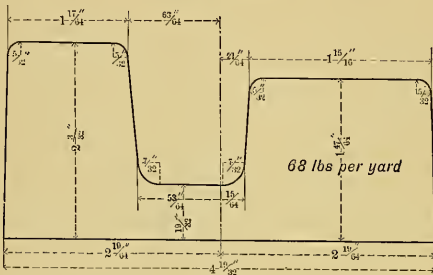

Fig. 16.

A few companies prefer one grooved rail for the inside of curves and a flat rail for the outside, upon which the car wheel travels on its flange.

The length along gauge lines of a curve with forty-five feet center radius turning a right angle is; on outer gauge line 892.6071 inches; on inner gauge line 803.8569 inches. The difference in length is 88.7502 inches. When both wheels are rigid upon an axle, one wheel must slide 7 feet, $\frac{4}{3}$ inches.

Some street railways, as above stated, to lessen this resistance, have the outside wheel travel around the curve upon its flange. The ordinary street car wheel has a diameter of thirty inches, with flange one-half inch deep. Suppose the inside wheel revolves upon its tread, having a diameter of thirty inches, its circumference = $30 \times 3.1416 = 94.248$ ". In the above distance $\frac{892.6071}{94.248} = 9.47$ revolutions. The wheel traveling upon its flange, with diameter of 31 inches $\times 3.1416$ has a circumference 97.3896 inches. In 8.5 revolutions, supposing there be no slipping, it travels 827.8116 inches. The length on outer gauge being 892.6071 deducting 827.8116, leaves 64.7955 inches or about three-fourths the distance, it has to slip when traveling upon its tread. This advantage is usually considered more than equaled by the fact that the flange, being comparatively sharp soon cuts grooves into the flat rail upon which it travels. With few exceptions all the large companies use rolled rails and cast iron curves are being abandoned. The superiority possessed by the rolled rails consists in the facts:

2. They weigh less per lineal foot, than cast iron curves.
3. They are more durable.
4. They can be laid more expeditiously.
5. They conform more accurately to the curve lines.

My practice is, with wooden stringers, to have pieces sawed to pattern for the curve, half the height of the ordinary stringer, eight feet long, surfaced top and bottom. I then lay these pieces, one on top of another, on the cross-ties, breaking all joints and spiking them together before the rail is put in.

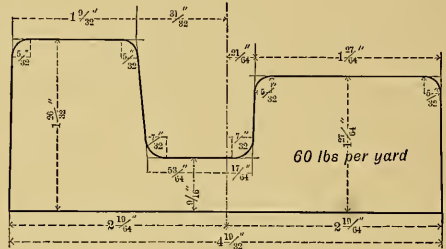

Fig. 17.

Wm. Wharton Jr. & Co. possess an enviable reputation for first-class work and furnish the majority of the street railway companies of this country with curves for wooden stringers.

The Johnson Steel Street Rail Co. do similar work when a girder rail is used.

The following bill is for steel rolled curves, upon a double track turning an angle of 90 degrees from a double track road.

| | |
|---|---------------------------------|
| Rails curved to center radius of 45 feet, 7,300 lbs., at 3 1/2 cts..... | \$255 50 |
| 1 Tongue Switch | } 5,164 lbs., at 3 1/2 cts..... |
| 1 Mate for Same | |
| 1 Open Point Switch | } 180 74 |
| 1 Mate for Same | |
| 6 Patent Crossings | } 13 60 |
| 1 Steel Tongue, 68 lbs., at 20 cts..... | |
| Drilling and Fitting..... | 5 00 |
| Freight and hauling from depot..... | 52 62 |
| Total..... | \$507 46 |

Materials in laying said Curves.

| | |
|--|---------|
| 80 Curve Circles, dressed to pattern, 25c..... | \$20.00 |
| 200 Knees, 19 1/2c..... | 39.00 |
| 6 Composition Chairs, 75c..... | 4.50 |
| 8 Curve Chairs, 50c..... | 4.00 |
| Spikes, \$2.55..... | 5.10 |

Total..... \$ 72 60

Total cost laid..... \$580 06

The cost of labor in laying curves is estimated at double that of straight track.

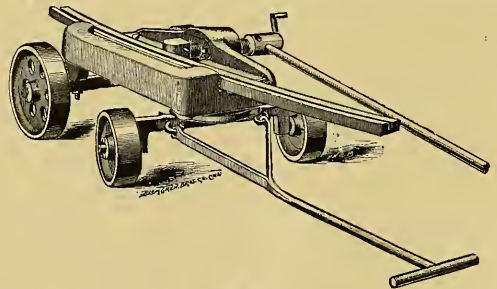

Fig. 27.

Fig. No. 27 shows a portable bending machine of Wm. Wharton's, which will be found quite a convenience.

Of course it is best for the street railway company to purchase curves complete, rather than to buy the rails and attempt to bend them to suit, for the railway can not do the work as well, nor so cheaply, as the manufacturer.

At times, however, it is necessary to bend one or more rails and such a machine as indicated in the illustration will be found better than the screw clamp frequently used.

If it should be necessary to bend a rail for a curve, the following table will prove useful. The first column contains different radii from 30 to 100 feet. The next column contains the middle ordinate, or distance measured square from half the length of a straight edge 20 feet long to the rail.

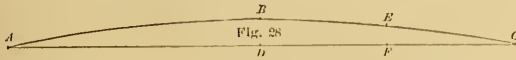

Suppose we want to bend a rail a, b, c to a radius of 45 feet. Looking in the column headed radius, we find 45 and opposite to it in the column marked middle ordinate we find $13\frac{1}{2}$ inches. This is the distance from B to D, that will exist between a point at the middle of the length

person, etc. may open the switch. If the open switch escapes the notice of the driver, he is liable to collide with a car, or other vehicle, upon the adjoining track, and an accident result.

I always use grooved rails, inside and outside on all cross tracks, with guard rails at the end, on straight track, eight feet long. Fig. No. 29 is an isometrical view of such a cross-over.

Wm. Wharton Jr & Co. make a patent crossing for curves. When one line is used more than the other, which is often the case in cross-overs, the main line tracks are unbroken, and when the rails constituting the latter are worn out, they can be renewed without interfering with the other track. These patent crossings are shown in the above cut.

Bill of items for cross-over track, having radii on center line of 100 feet. Bessemer Steel Rails, 60 lbs. per yard. Length in street from end to end, 60 feet.

- 2 Inside Rails, { Radius, 97' 7 $\frac{3}{4}$ "
Length, 17' 7 $\frac{3}{4}$ "
Straight, 9 $\frac{3}{8}$ "
 - 2 Outside Rails, { Radius, 102' 4 $\frac{1}{4}$ "
Length, 19' 10 $\frac{5}{8}$ "
Straight, 1' 9 $\frac{3}{8}$ "
 - 1 Guard Rail, { Straight
Length, 10' 0"
- } 1,700 lbs., at 3 $\frac{1}{2}$ cts. \$ 59 50
- 1 Right Hand Tongue Switch
 - 1 Mate for Same
 - 1 Right Hand Open Point Switch
 - 1 Mate for Same
 - 2 Frogs
- } 4,220 lbs., at 3 $\frac{1}{2}$ cts. 147 70

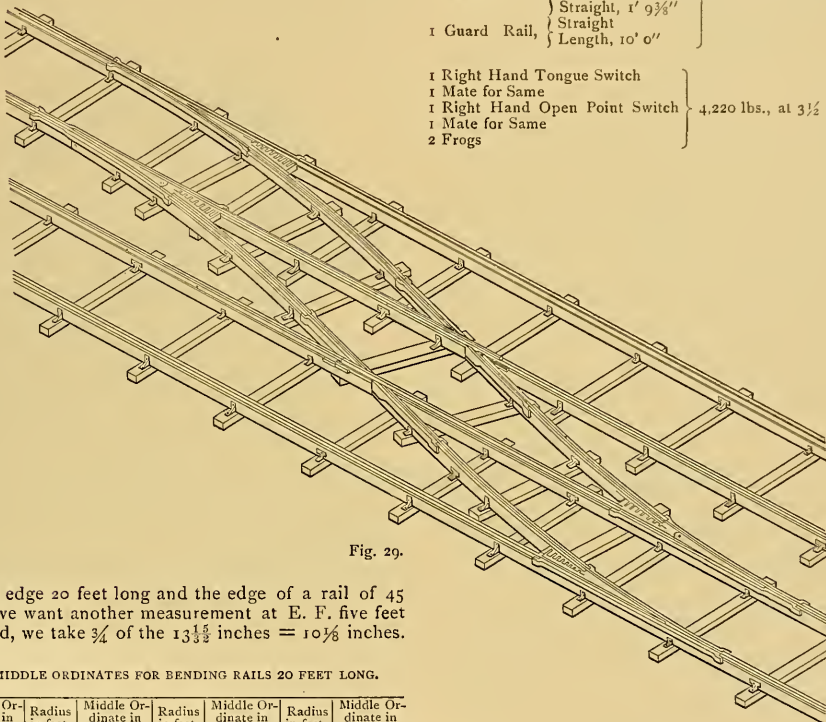

Fig. 29.

of a straight edge 20 feet long and the edge of a rail of 45 radius. If we want another measurement at E. F. five feet from one end, we take $\frac{3}{4}$ of the $13\frac{1}{2}$ inches = $10\frac{1}{8}$ inches.

TABLE OF MIDDLE ORDINATES FOR BENDING RAILS 20 FEET LONG.

| Radius in feet. | Middle Ordinate in inches. | Radius in feet. | Middle Ordinate in inches. | Radius in feet. | Middle Ordinate in inches. | Radius in feet. | Middle Ordinate in inches. |
|------------------|----------------------------|------------------|----------------------------|------------------|----------------------------|------------------|----------------------------|
| 30 | 20 $\frac{1}{8}$ | 47 $\frac{1}{2}$ | 12 $\frac{3}{8}$ | 65 | 9 $\frac{3}{8}$ | 82 $\frac{1}{2}$ | 7 $\frac{3}{8}$ |
| 32 $\frac{1}{2}$ | 18 $\frac{3}{8}$ | 50 | 12 $\frac{1}{4}$ | 67 $\frac{1}{2}$ | 8 $\frac{3}{8}$ | 85 | 7 $\frac{1}{8}$ |
| 35 | 17 $\frac{3}{8}$ | 52 $\frac{1}{2}$ | 11 $\frac{1}{2}$ | 70 | 8 $\frac{1}{8}$ | 87 $\frac{1}{2}$ | 6 $\frac{3}{4}$ |
| 37 $\frac{1}{2}$ | 16 $\frac{3}{8}$ | 55 | 11 | 72 $\frac{1}{2}$ | 8 $\frac{3}{16}$ | 90 | 6 $\frac{3}{8}$ |
| 40 | 15 $\frac{3}{8}$ | 57 $\frac{1}{2}$ | 10 $\frac{3}{8}$ | 75 | 8 $\frac{1}{16}$ | 92 $\frac{1}{2}$ | 6 $\frac{1}{8}$ |
| 42 $\frac{1}{2}$ | 14 $\frac{3}{8}$ | 60 | 10 $\frac{1}{8}$ | 77 $\frac{1}{2}$ | 7 $\frac{3}{8}$ | 95 | 6 $\frac{1}{4}$ |
| 45 | 13 $\frac{1}{2}$ | 62 $\frac{1}{2}$ | 9 $\frac{3}{4}$ | 80 | 7 $\frac{1}{8}$ | 100 | 6 $\frac{1}{8}$ |

CROSS TRACKS.

Cross-over tracks are required, when it is necessary for the cars to pass from one line of a double track road, to the other.

I have adopted a standard cross-over with a center radius for reverse curves of 100 feet.

They should be laid, whenever it is possible, so that the switch is never opposed to the ordinary car traffic. If this is not attended to, a passing wagon, maliciously disposed

- 1 Crucible Steel Tongue and Pin, 77 lbs., at 20 cts. 15 40
- Drilling and Fitting 5 00
- Freight and teaming 17 76

Cost of putting the above in track. Total.....\$245 36

- 1 Day Foreman, \$3 50.....\$ 3 50
- 17 " Labor, \$1.50..... 25 50
- 2 " Carpenters, \$2.25..... 4 50
- 1 " Team, \$4 00..... 4 00
- 20 Curve Circles, dressed to Pattern, 25 cts..... 5 00
- 20 Knees, 19 $\frac{1}{2}$ cts..... 3 90
- Spikes 2 55
- 1 Composition Chair..... 75

\$49 70

Total in street.....\$295 06

Figs. 30 and 31 give an isometrical view of a patent crossing for horse and steam railroad tracks. The latter are unbroken, and the wheel of the horse car passed over the head of the steam railroad rail.

In a case where a double track horse railway passed over a double track steam railroad the 12 castings complete weighed 18,935 and cost at 3½ cts. per pound f. o. b. Philadelphia \$662.72.

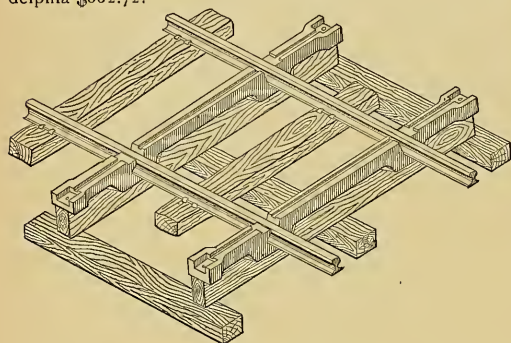

Fig. 30.

Fig. No. 32, shows the Johnson Automatic Switch, which I have used some years and found satisfactory. The cost of the switch, without royalty, is \$225.00 f. o. b. in Philadelphia. It is turned by the weight of a horse transmitted through levers, and does not retard the car, thus saving the horse the great strain of starting.

It saves the conductor the task of jumping off his car, and running forward to turn the switch. Where lines separate, more people are apt to get on and off, than at other points, and it is very desirable that the conductor should be on his car to prevent accidents. He can keep his car and himself neater if he does not have to wade through mud to set a switch.

Some method of draining should be provided, for otherwise water is apt to congeal in the box during cold weather and interfere with its working.

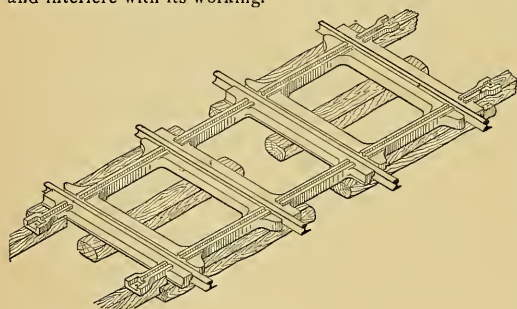

Fig. 31.

TURN-TABLES.

Many roads prefer to turn their cars at each end of a line thus always running the same end foremost. The front platform can then be enclosed and devoted exclusively to the driver, when box cars are used, lessening the danger to patrons in getting on or off the cars.

There is always more or less danger in transferring the horses from one end to the other of a car in a crowded city street.

Figures 33 and 34 show Wharton's Cast Iron Turn-table. Turn-tables are also manufactured by Andrews & Clooney; Bowler & Co.; S. M. Carpenter; Hathaway & Robinson; Tom L. Johnson; Johnson Street Rail Co.; Maher & Brayton, etc.

The objection to turn-tables in city streets is danger to passengers who attempt to get on or off the car while turning and to people or vehicles passing in the street.

CONTRACTORS.

Street railway companies, especially new roads, will find it more economical and far better to let the contract for the construction of their roads, to *experienced* and responsible contractors.

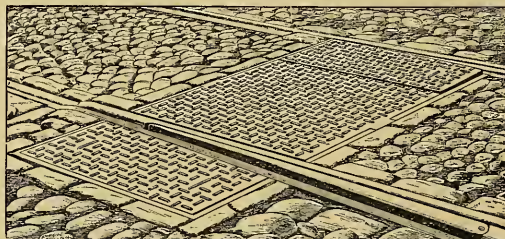
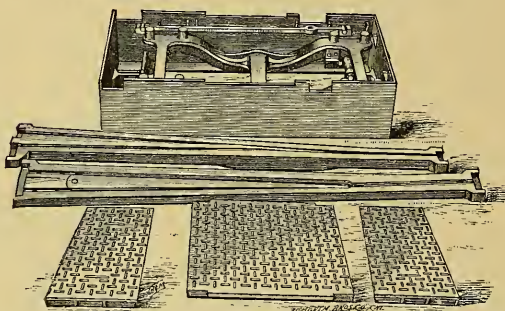

Fig. 32.

Having had twelve years' experience upon steam railroads, the majority of them as chief engineer, I began street railroad work with the impression that my knowledge would prove useful.

A short space of time sufficed to convince me, that the work was entirely different, and I had to begin *de novo*.



It has been largely the practice with street railway companies to build their own tracks, and the condition of many roads to-day, proves the folly of this system. Very few steam railroads find it advantageous to construct their own roads, and I am at a loss, why street railways should pursue a different policy. Instances have come under my observation where contractors of many years' experience in street railway construction have offered to do the work for new companies. The latter considered the price too high. Employed a foreman, bought material and built the road after a fashion. The results were, that they found the roads had cost more money (and were not nearly as good), as if an experienced contractor had done the work. It is assumed by these companies that any ignorant man, although he might never have seen a street railway built, could superintend *their* work, provided he did not want more than two or three dollars per diem.

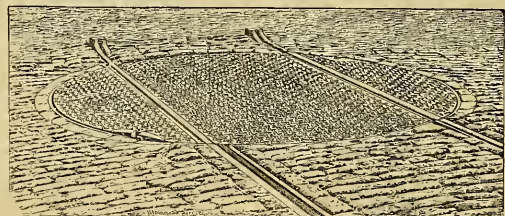

Fig. 33.

The lack of all mechanical skill evinced upon many a prominent street railway in its track construction is most deplorable.

I have seen tracks laid with the rail joints *directly over stringer joints*.

I have seen a common laborer employed to adz into the stringer, for the joint' chair. He cut one end *half an inch* too deep, and to make the rail heads come even on top, inserted a chip of pine, between the bottom of the rail and the chair, to be crushed by the first loaded car wheel. With such work is it strange that we hear a moan "Poor tracks?"

If the contractor were encouraged, the men would be more permanently employed; in a measure his interest and theirs would be identical in doing good work, for unless he maintained a reputation for thorough construction, the contracts would be awarded to one who did, and his men would not stand the same chance for steady employment. The company would get better tracks than under the day labor system and at less cost. It is proverbial that employees do more work for an individual or a firm, than for a corporation. When engaged in track construction it is to their interest, *not* to do the most work for the least money, but to *prolong the job*. In contracting for such work, the overtaxed street railway official is relieved of all actual work, and has only to inspect the completed construction. The company knows the exact cost of the work in question, which is rarely the case under the present system.

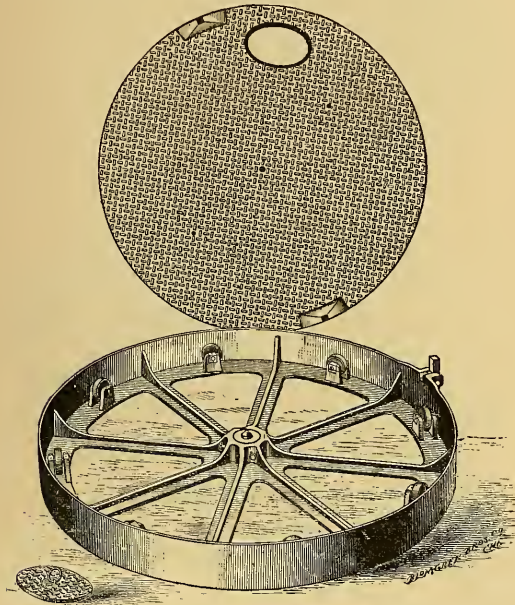

Fig. 34.
To be continued.

The most remarkable evidence of the intellectual force that lies dormant in the community until some important event calls for its exercise, has been illustrated in the recent discussions of the labor question. Until the occurrences of the last year there was but a limited amount of literature on the subject of Socialism, strikes, boycotts, arbitration, co-operation and profit sharing. The general newspaper press and the magazines of the country have now turned their attention to these subjects. In the last issue of the *North American Review*, the following subjects are treated: "Shall Capital or Labor Rule?" by Henry Clews, "Strikes, Boycotts, Knights of Labor," by Rufus Hatch; "Arbitration, Co-operation, Profit Sharing," by S. B. Elkins.

We have not yet had time to examine these articles in detail, but we have read the pamphlet of Mr. Elkins on the question treated in his magazine article, and unhesitatingly pronounce it an able presentation of the burning question.

HEATING RAILWAY STATIONS AND WAITING ROOMS.

The use of steam or hot water for warming buildings has made rapid advances in public favor during the past few years. Stoves and fire-place heaters are debilitating—are annoying with their dust and dirt—are laborious in their

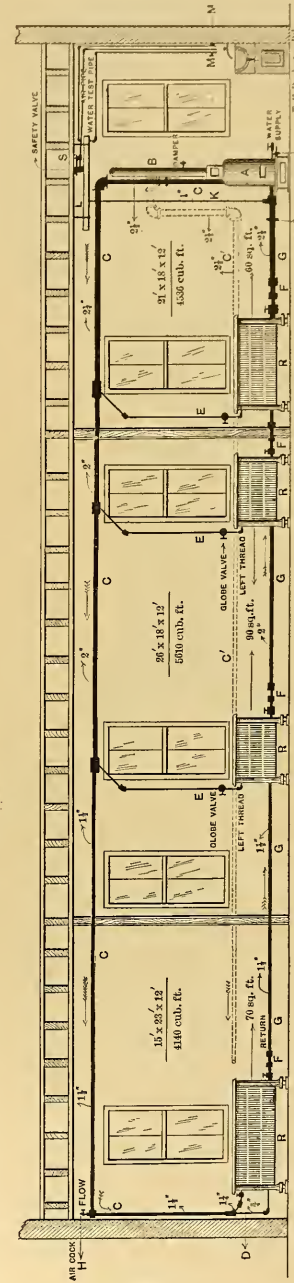

FIG. 1.

Elevation Showing Arrangement of Hot Water Apparatus, Fig. 1.

- A. Water circulating boiler.
- B. Smoke pipe with damper.
- C C C. Main flow pipe with flange union.
- C' C' C'. Main flow pipe as by dotted lines passing below windows and at back of radiators.
- D. Circulating pipe.
- E E E. Flow pipes to radiators with gate stop valves.
- F F F. Return pipes connections to main return with gate stop valves.
- G G G. Main return pipes.
- R R R. Radiators.
- H. Air cock on high end of main flow pipe.
- K. Connection to expansion pipe.
- L. Expansion pipe on hangers with air and water test pipes and safety valve.
- M M. Air and water level test cocks, and safety valve waste pipe at some convenient point near basin or sink or above bath. These cocks, etc., are only used when starting apparatus.
- S. Safety valve with waste pipe; this seldom operates unless when excessive firing takes place.

care, are dangerous, as the long list of accidental fires from overheated flues testify; and they are not used excepting

through necessity and the force of circumstances. In railway stations and waitingrooms the traveling public are frequently annoyed by foul air and coal gas occasioned, it may be, by an unsightly, red hot stove, around which groups of persons gather who are not overparticular about the comforts of others and the cleanly appearance of the surroundings.

The accompanying engravings represent an apparatus and system for heating a railway station or waiting room by means of hot water. It is simple and efficient, and consists of a water-circulating boiler, with main flow and return pipes connected to radiators or coils, all placed on the same floor level. These circulators are from 14 to 25 inches in diameter, and not higher than an ordinary stove. The self-feeding with coal magazine is of sufficient capacity to contain enough coal to last from ten to twelve hours. There is no flue cleaning necessary. The smoke-pipe enters an ordinary stove chimney flue. In ordinary large waiting rooms one to two scuttles of coal are sufficient for ten to twelve hours. The fire is easily maintained night and day.

The arrangement of the flow and return pipes, shown in Fig. 1, has been designed by the manufacturer to overcome the necessity of using high pressures in water cir-

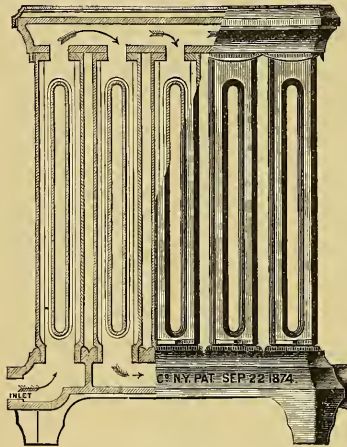

FIG. 2.

ulation, such as 200 and 300 pounds, which pressure increases the first cost as well as the unnecessary consumption of coal. In this apparatus circulation begins the moment the temperature of the water has acquired one degree of heat. In other words, as soon as the water takes up the heat, it begins to give it out to the apartment, instead of being taken up and wasted while attaining a very high pressure to force circulation. It is here that the great economy of this system is found to be so satisfactory. Any water radiator or horizontal pipe coils can be used, but vertical pipe radiators are preferable, as they present fewer impediments to circulation. Such a radiator is illustrated by Fig. 2. This radiator is known as the Bundy patent. It is exceedingly simple, durable and effective. Every allowance is made for expansion in the method of connecting the base and top to the vertical pipes, thus providing against the

PLAN AT F ENLARGED.

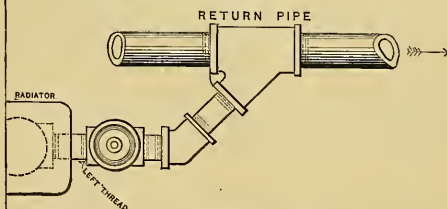

FIG. 3.

possibility of leaks. The expansion of the water in this

apparatus, which is closed, is provided for in an expansion expansion tank fitted with air and water level test.

Fig. 3 shows the manner of connecting radiators with a return pipe which passes behind them. It will be observed that Fig 4 represents what is known as the Mahony steam boiler, but the hot water circulating boiler is similarly constructed, and of course is filled completely with water and is without gauge, safety and steam dry pipes.

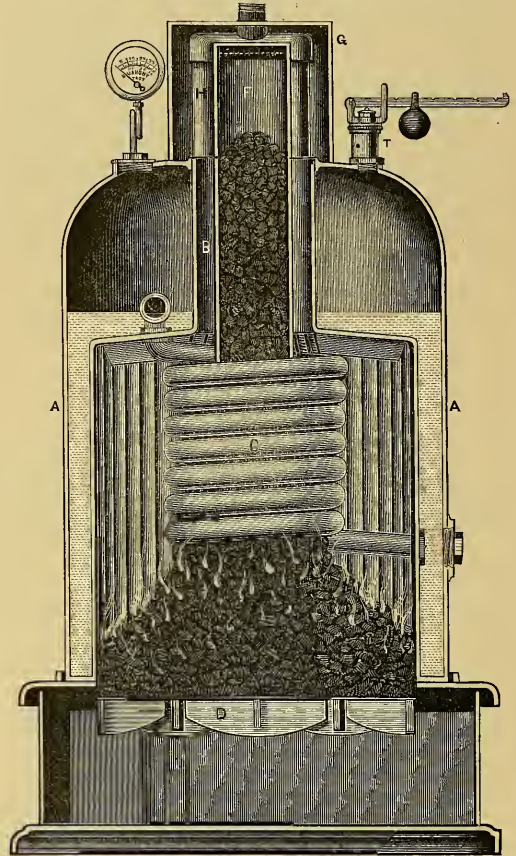

FIG. 4.

SECTIONAL VIEW OF STEAM BOILER, WHICH IS ALSO ADAPTED FOR A HOT WATER CIRCULATING BOILER.

- A. External shell, cast in one piece.
- B. Corrugated fire box and uptake.
- C. Circulating coil of wrought iron pipe.
- D. Rocking grate.
- F. Coal magazine, the end of which just enters coils, which form the lower portion of the magazine, in contact with the fire.
- G. Cast iron top, covering magazine and steam dry pipes with sleeve for smoke-pipe connection on back.
- H. Steam dry pipes.
- T. Safety valve lever and weight.

NEW YORK STREET-CAR FARES.

After June 1 the fare at all hours on the 2d and 9th avenue elevated roads in New York will be 5 cents instead of 10 cents, as at present.

These roads run through a part of the city largely inhabited by the working people, and it is very commendable for the elevated roads to reduce their fares 50 per cent. This reduction will not only prove a good thing for the people, but it will largely increase the patronage of these roads. It goes without saying that all franchises of this kind are created for the benefit of the masses, and the fares should be made as low as the best interest of the roads will permit.

A PLEA FOR THE HORSE.

The publishers having kindly furnished engravings, we now continue the review of Mr. Wood's book. As a result of following the instructions for "improved" shoeing, quoted in an earlier issue, we present fig. 1, from a drawing of an actual hoof in the author's possession. The improvement is very visible.



FIG. 1.

In contrast to which we give the picture of another actual hoof which after being as badly deformed as the other, was restored to the state shown by fig. 2 very soon after being allowed to remain unshod. In case the frog has been cut away, and the hoof thus rendered incapable of fulfilling its proper functions, Mr. Wood recommends the Hartman safety pad, fig. 3.



FIG. 2.

This is a rubber imitation frog, springing in, under the edges of the shoe.

Mr. Wood recommends *no shoe*, as we have seen, but in case a shoe is deemed absolutely necessary, recommends the Charlier as the best. This shoe is undoubtedly a very good one in theory, but requiring a special instrument for cutting the offset around the walls of the hoof, is worth but little in practice. Fig. 4 represents this shoe in position on the hoof.

The evil tendencies of the heel calks in throwing a wrong strain on the muscles of the leg, are well shown

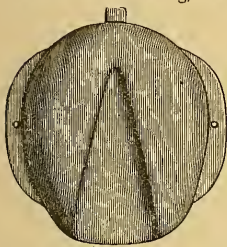

FIG. 3.

in the pair of feet shown in fig. 5, where "A" is the hoof with calks and the companion piece shows the position of the hoof with the shoe removed.

In reviewing the subject, we would direct attention to the strong argument made by the author in favor of the unshod hoof. It is useless to deny the fact that his points are well taken and strongly fortified; yet the argument is one-sided. We have

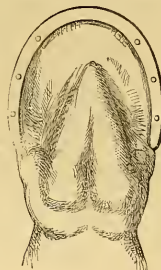

FIG. 4.

seen the experiment tried by enthusiastic believers in the naked hoof, and abandoned after fair and repeated trials. That the horse in his native state, unladen and free to travel or remain at will, needs no shoe, is certain; but with heavy loads to bear or draw over artificial pavements, we cannot but think some sort of shoe is necessary. This has, we think been demonstrated by universal experience, but we agree with Mr. Wood in so far as to set it down as an axiom that the less of a shoe one can get along with, the better it will be for his horse. The remaining question is as to the proper shoe. Mr. Wood, as

we have seen, recommends the Charlier, and he makes the mistake of supposing the Goodenough shoe to be out of the market. American horsemen, however, need not be informed that this is an error, as the shoe is in very extensive use. It is the writer's personal opinion that this is the best shoe

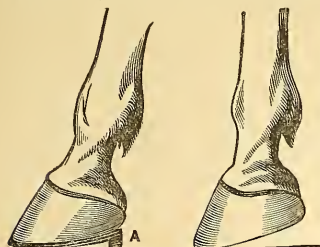

FIG. 5.

made, to give the necessary resistance to battering, and at the same time to allow every portion of the hoof to fulfill its proper functions.

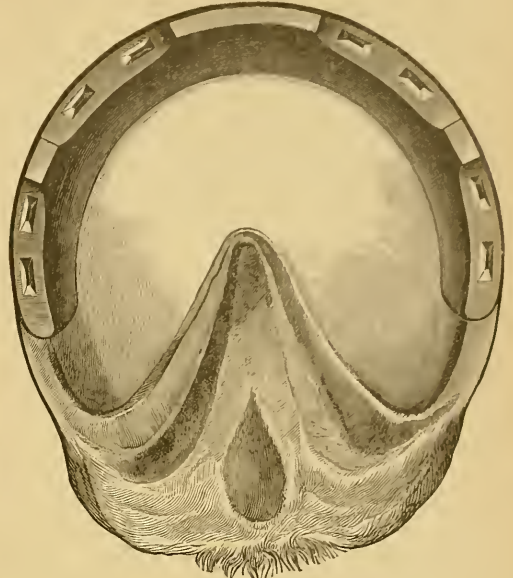

FIG. 6.

Fig. 6 shows a hoof shod in this manner.

(To be continued.)

THE SUBURBAN RAPID TRANSIT RAILROAD OF NEW YORK.

The first section of which was opened for travel on May 17th, was organized under the provisions of the Rapid Transit Act by commissioners appointed by Mayor Cooper, on March 6th, 1880. The routes authorized by its original charter, together with those since acquired by lease, comprise twenty miles of lines in that part of New York City which lies north of the Harlem River. Only a small portion of these lines is along streets, the greater part following the routes expressly designated for steam railroads on the plans for laying out the "annexed district," prepared by Mr. J. J. R. Croes, the Civil and Topographical Engineer of the Department of Public Parks in 1877, and adopted by the department. These routes lie through the centres of blocks, over which the railroad company purchases its own right of way.

The advantages of this system are seen in the portion of the Suburban Road which is now ready for travel, the structure being composed of massive plate-iron girders resting on brick piers, and capable of carrying heavy trains at high speed with less noise than is made by the elevated railroads in the street south of the Harlem River, while the cost of the structures is considerably less than that of the street roads.

The railroad begins on the south side of the Harlem River, where connection is made at One Hundred and Twenty-eighth Street with the Second Avenue line of the Manhattan Elevated Road. The river is crossed on a handsome drawbridge, at an elevation of thirty-two feet above mean high-water, and the road then passes over the freight yards of the Harlem River and Portchester Railroad, on a lofty iron viaduct, on which four tracks are provided, two of them descending to form a connection with the surface-tracks of that railroad, and enable passengers on its line from Morrisania to New Rochelle to be landed directly at the transfer station of the Second Avenue Elevated Road.

The other two tracks proceed northwardly between Alexander and Willis Avenues to One Hundred and Forty-third Street, where two lines diverge, one going northeastwardly four miles to West Farms and the Bronx Park, the other going westwardly and northwardly to Jerome Park, with branches on Third Avenue, and to a connection with the New York City and Northern Railroad at their bridge opposite Eighth Avenue.

The drawbridge at Second Avenue and a mile of the Stem Line have been constructed, and it is announced that contracts for several miles of the road will be let at an early day, the plans and specifications being nearly ready and the arrangements made.

Trains will be run at present from 5:30 A. M. to 9 P. M., at frequent intervals, between the transfer station at Second Avenue and One Hundred and Forty-third Street.

The numberless obstacles which are thrown in the way of any new great enterprise in New York City have been patiently overcome by the quiet and persistent management of Mr. Samuel R. Filley, the president of the company, to whom is due the credit of having put on a solid basis this important company, and of having had built in the most economical and substantial manner works which cannot be valued at less than a million dollars, and are well worth what they have cost. Mr. Croes, who designed the general scheme of the work while in the Park Department, and was one of the engineers to the Rapid Transit Commission which established the routes, has been the Chief Engineer of the company since its organization, and had charge of all its plans and constructions.

In the designing of the iron structures he has had the services of the well-known iron bridge expert, Mr. Theodore Cooper, and as resident engineer of the construction, Mr. H. W. B. Phinney, whose efficient service is sufficiently attested by the excellent character of the workmanship.

STEAM STREET CARS.

The annexed cut represents the machinery and framework of a steam street car before the car body is placed in position. This shows how easily steam car machinery can be adapted to existing cars. The cylinders with rods and connections, wheels, and boiler are all entirely independent of the car body, being connected to and carried by a strong channel iron frame. On this framework the car body rests, and is held in position by bolts passing through the cross braces. The frame-work can be made of any required dimensions to

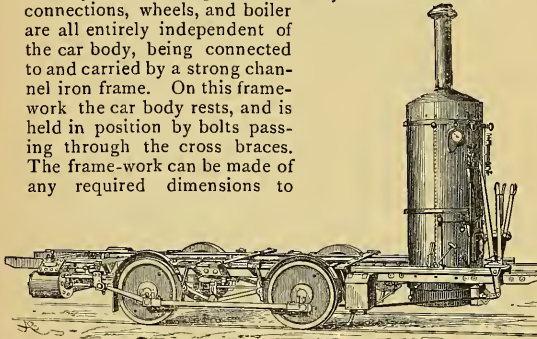

suit car bodies, and the machinery, with wheels, framework, boiler, etc., can be supplied without car bodies. The cylinders for steam cars, as constructed by the makers, are 8x10 inches; diameter of driving-wheels, 30 inches; spread of driving-wheels, 6 feet; length of car over all, 22 feet, 6 inches.

NEW YORK AND BROOKLYN BRIDGE.

The New York and Brooklyn Bridge receipts for April were \$62,278. The month's expenditure for new cars and real estate leaves the net income apparently nil. The extension on the New York side is in progress, and involves changes in the approaches to the elevated railway. The Payne grip is still used and continues to operate without trouble. The accommodations for carrying passengers during the morning and evening rush are at present not equal to the demand, although the trains are run with about two

or three minutes headway, and everything is done that can be done with safety. The Secretary's traffic statement for last month was as follows:

| | Promenade. | Carriage Ways. | Railroad. | Totals. |
|-----------------------------|------------|----------------|-------------|-------------|
| Receipts from New York..... | \$938.39 | \$2,695.67 | \$25,354.99 | \$28,989.05 |
| Receipts from Brooklyn..... | 696.90 | 2,726.96 | 29,865.95 | 33,289.81 |
| Totals..... | \$1,635.29 | \$5,422.63 | \$55,220.94 | \$62,278.86 |
| Daily average of receipts | | | | |
| For April..... | \$54.50 | \$180.75 | \$1,840.69 | \$2,075.96 |
| For March..... | 41.41 | 161.02 | 1,841.60 | 2,044.04 |
| For April, 1885.. | 67.15 | 173.75 | 1,279.90 | 1,520.81 |
| For April, 1884.. | †137.66 | †211.23 | †1,253.70 | †1,602.60 |

COMPARISON.

| | Promenade. | Carriage Ways. | Railroad. | Totals. |
|-------------------------------|------------|----------------|-------------|-------------|
| Receipts | | | | |
| For April, 1885.. | \$2,014.62 | \$5,212.70 | \$88,397.10 | \$95,624.42 |
| For April, 1886.. | 1,635.29 | 5,422.63 | 55,220.94 | 62,278.86 |
| An increase of..... | 379.33 | 209.93 | 16,823.84 | 16,654.44 |
| A decrease of..... | 379.33 | ----- | ----- | ----- |
| Receipts | | | | |
| For March, 1886.. | 1,283.89 | 4,991.74 | 57,089.85 | 63,365.48 |
| An increase for April of..... | 351.40 | 430.89 | ----- | ----- |
| A decrease of..... | ----- | ----- | 1,868.91 | 1,866.62 |

† Before reduction of tolls.

CASH FARES AND TICKETS.

| | Promenade. | Railroad. | Totals. |
|---|------------|---------------------|-----------|
| Number of cash fares at 1c..... | 124,274 | at 3c, 1,006,693 | 1,130,972 |
| Number of tickets sold (25 for 5c)..... | 106,275 | (10-25c), 1,000,800 | 1,197,075 |
| Increase of cash fares for April over March..... | 26,215 | 12,303 | 38,518 |
| Increase of number of tickets sold in April over March..... | 44,625 | ----- | ----- |
| Decrease of number of tickets sold in April..... | ----- | 89,520 | 44,895 |

PASSENGERS AND OUTSTANDING TICKETS.

| | Promenade. | Railroad. | Totals. |
|--|------------|------------|------------|
| Total Passengers..... | 283,549 | *2,007,498 | *2,291,047 |
| Daily average of passengers for April..... | 9,452 | 66,916 | 76,368 |
| Daily average of passengers for March..... | 7,266 | 67,246 | 74,512 |
| Whole number of outstanding tickets (April 1)..... | 977,875 | ----- | ----- |
| Whole number of outstanding tickets (May 1)..... | 1,014,875 | ----- | ----- |
| Outstanding tickets for April..... | 37,400 | ----- | ----- |

* Estimated from receipts.

Treasurer Swan's income and maintenance account for the preceding month was as follows:

| | |
|---|--------------|
| April 1—Cash on hand and in bank..... | \$73,372.54 |
| Receipts from tolls: | |
| From the promenade..... | \$ 1,635.29 |
| From the carriage-ways..... | 5,422.63 |
| From the railroad..... | 55,220.94 |
| | \$62,278.86 |
| From the Pullman Palace Car Co., labor..... | 90 |
| For interest from receiver Atlantic State Bank..... | 3,342.73 |
| | \$138,995.03 |

EXPENDITURES.

| | |
|---------------------------------------|-------------|
| Property on Stewart's alley..... | \$ 2,000.00 |
| Six Pullman Palace cars..... | 22,650.00 |
| Legal expenses..... | 1,593.65 |
| For labor, salaries and supplies..... | 38,747.81 |
| | \$64,991.46 |

CASH IN BANK AND ON HAND.

| | |
|-------------------------------------|-------------|
| Long Island Bank..... | \$28,329.59 |
| Brooklyn Trust Company..... | 25,190.31 |
| Commercial National Bank..... | 18,223.74 |
| Cash on hand—tolls of April 30..... | 2,015.26 |
| Cash on hand..... | 241.67 |
| | \$74,003.57 |

Passenger (to conductor on Third Avenue car)—You are not one of the new conductors, are you?

Conductor—Yes; never worked on a car before.

Passenger (somewhat astonished)—Is it possible? I should have said that you are a conductor of long experience.

Conductor—Why?

Passenger—Because you've got seventeen passengers aboard and only twelve fares registered.—Life.

THE FLETCHER CAR BRAKE.

A street car brake, which is used much oftener than that of a steam car, is about as crude an affair as could well be devised. By means of an inconvenient handle, inconveniently placed, the driver winds up upon a vertical spindle, a chain which drags upon two beams, each carrying two brake-shoes which engage the circumference of the wheels. When the brake is applied the two beams are actuated with different degrees of force, and the two brake-shoes upon each are pressed with different degrees of force upon the wheels. It is absolutely impossible to get and maintain exactness of position and pressure between the two beams, and between the two shoes upon each beam. The operation of effecting this imperfect result is inconvenient, awkward and slow. The shoes pressing against the peripheries of the wheels, tend to wear them in grooves, thus lessening the life of the tread of the wheels, and also wearing the flanges thin. The brakes are sometimes about as difficult to get off as they are to put on. The grip which they have upon the wheel is but slight; very often not enough to hold the car upon a steep grade when there is a train or an open draw at the bottom of the grade. There are few who had not had hair-breadth escapes from running into, or being run into by, a fire engine, or a locomotive, by reason of defective brakes. Drivers cannot always attend to horses and brake at once; the horses get the attention, and the brake is let alone. When the front platform is crowded, and this is often the case, the ordinary brake cannot be worked to advantage, the brake handle becomes a nuisance to both driver and platform passengers. There are times, too, when by the brake being let off suddenly, or coming off suddenly, the handle has done mischief in the way of broken arms, or bones, of some one upon the ground level just behind the back platform. Every one knows what a noise the common brake makes, and how it grates upon the nerves. Having convicted the old fashioned brake of being inconvenient, uncertain, weak, noisy and generally inefficient and unsatisfactory, we will now see what is desired in a brake to make it do all that it should do.

The action of the brake should be prompt. It should be powerful. The brake should be applied upon the front wheels just exactly at the same time, and with the same pressure as upon the back ones. It must be applied upon each side of the car alike. It must not be an annoyance to passengers upon the platforms, nor to passers by. It must not take attention away from the horses, nor must it require that it be attended to, to the neglect of the horses. It must not be complicated. It must be durable. It must not wear out any essential part of itself, nor of the wheel. It must be cheap in first cost of application, and in repairs.

In the brake shown here in working proportions and dimensions, the brake-shoe is not applied to the rim of the wheel, where it would wear out valuable metal, but to special pieces of cheap casting fastened upon the axle. The surface to which the brake is applied is not a smooth cylindrical one like that of the wheel tread, but one consisting of a number of circular V grooves in which V shaped projections upon the shoes engage with a combined frictional and wedging action. The parts (1) to which the shoes (3) are applied, are ordinary castings, (preferably chilled in the grooves) made in halves and bolted to the axle. If desirable the grooves may be turned or ground out when the halves are bolted together. The shoes are not fastened to swinging beams causing lost motion, but are applied to curved levers

of the second-class, running parallel with lengthwise axis of the car. These curved levers (4) are pivoted in vertical cast iron brackets (5) bolted to the bolsters. The levers are continued back of the pivots (6), one of them with a downward extension and the other with an upward (or bell crank); and these two extensions are connected by the straight cast link piece (8), so that the motion of either lever will make the same amount of motion in the other, the application of either brake-shoe causing that of the other, and the release of one affecting that of the other, at the same time and in the same degree. Wrought iron continuations (9) of the curved levers (4) are placed in pocket in the ends of the levers (4), and extend under the platform to below the dash-board. Here each engages vertical fork pieces (11), lying close to the dash-board. Each fork piece has vertical motion given it by a cam handle having lateral motion so that when the driver wishes to put on a brake all that he has to do is to do is to press the handle to one side, thus depressing the fork piece and throwing out the brake lever, and engaging the Vs., of the brake-shoe with those of what might be called the braking piece (1). Suitable springs provide for the release of the brake as soon as the driver's hand is taken from the handle, and also for any possible teetering of the car giving too much or too little braking power by jamming or partly releasing the wedges.

It will be seen that the number of pieces employed is but few; that they are for the most part simply unfinished castings; what little finish required being of the cheapest character. As to the amount of braking power that can be got by this means, it is practically unlimited. It is the ordinary stop brake, (which is well-known to any one who has worked in mines), intensified by means of the Vs. As regards the Vs., their gripping power depends only upon their acuteness. The more acute they are, the greater their wedging and gripping power. 60° will probably be found the maximum sharpness necessary. It is better to have several small grooves than one deep one, as the pressure upon them need be less, and the wear will be more uniform.

It will be seen that by having a hard braking piece and a soft brake we get the greatest wear upon that piece which is the cheaper and the more readily replaced, that we are also wearing out a cheap piece of ordinary soft iron, instead of the expensive tread of the chilled wheel.

The extreme promptness and sensitiveness of this brake will commend themselves to every driver and to every passenger, as the brake remains at all times in the most perfect and easy control.

There is a locking device by which a brake may be fastened on, so that the driver may leave the platform when the car is stopped upon a hill, and get out to attend to his horses. There are adjusting holes provided in the lower end of the vertical fork piece, to permit of the brake-shoe being placed and kept close to the braking piece, without actually touching it, and by this device the wear of the brake shoe may be followed up to the limit of safety and the maximum amount of wear got out, before renewing the shoe.

This brake is intended to be applied by using the foot; the hand is not to be used only on long grades, thus leaving both hands free to drive the horses, make change, etc.

When you see a man call the conductor's attention to the fact that there are only ten persons sitting on his side of a crowded horse-car, just look a little closer and ten to one you'll find that he is sandwiched in between two pretty girls.—*Somerville Journal*.

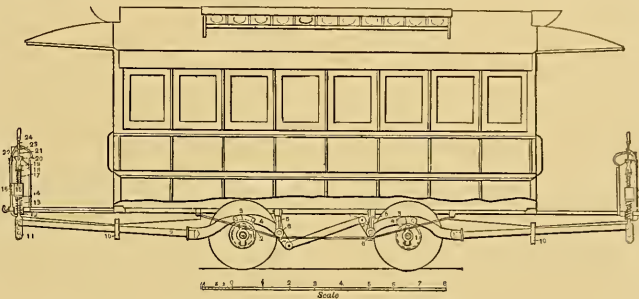

THE
STREET RAILWAY GAZETTE

JUNE, 1886.—MONTHLY, \$2.00 PER YEAR.

COPYRIGHTED JUNE, 1886.

WRIGHT, MONROE & CO.,
PUBLISHERS.

GENERAL OFFICES:

| | |
|---------------------------------|-----------------------|
| NEW YORK, | 181 Broadway. |
| H. D. Cozens, - - - - - | Business Manager. |
| T. P. Pemberton - - - - - | Associate Editor. |
| CHICAGO, - - - - - | 43 Lakeside Building. |
| P. G. Monroe, General Manager. | |
| E. V. Cavell, Business Manager. | |

| | |
|--------------------------------|------------|
| Angustine W. Wright, - - - - - | } Editors. |
| Henry C. Lockwood, - - - - - | |
| George B. Heckel, - - - - - | |

BRANCH OFFICES.

Philadelphia, Pa., 105 N. 4th St., J. Waterkeyn, Manager.
 Cincinnati, 175 Vine St., Frank Trainor, Manager.
 Pittsburgh, Pa., James Loughran, Manager.
 St. Louis, Mo., 709 Olive St., Frank W. F. Scholl, Manager.
 Atlanta, Ga., Chamber of Commerce Bldg., Wm. Minnigerode, Mgr.
 St. Paul, Minn., 558 Drake Block, V. R. Benham, Jr., Manager.
 San Francisco, Cal., 1322 Pine St., G. W. Fairchild, Manager.
 New Orleans, La., J. P. Brady, Manager.

It has been seriously argued that the franchises for a street railway should be granted to the company that will carry passengers at the lowest rates.

Jaehne is said to be well behaved in prison. If he had manifested this characteristic as an alderman, he would have had a larger choice in the selection of his place of sojourn on the banks of the Hudson.

The recent developments in the peculiar modes of legislation suggest that if any consideration for the privilege of building street railways is to be exacted, that it should be paid into the public treasury, and not into the private bank account of the statesmen of our cities.

When the gentlemen, whose duty it is to enforce the law in relation to strikes and boycotts, took the trouble carefully to examine its provisions, it was discovered that there was not so much need for more statutes as a demand for the honest administration of the law as it now obtains.

At a meeting of ministers recently held at Cleveland, there was a free interchange of thought touching the propriety of using the steam and street cars in going to and coming from public worship on Sunday. From the published account it is not definite what action was finally taken, but it appears that several of those present made an argument against the use of street cars on this day, and took the position that there is really no necessity for them, and that people in the city had better attend churches near their homes. It was thought that if the general public could be convinced of the wisdom of this course, it would follow that the use of cars, horses and carriages would not be necessary on the Sabbath.

The representatives of the people who met at Albany, passed a law providing for the construction of the Arcade Railway. The Governor approved the law. One would naturally believe that this was the end of the whole matter, so far as the law and its administration are concerned. But this is a violent conclusion. Many real estate owners along Broadway and Madison Avenue have resolved to oppose the building of the road. They have retained a strong legal force to appeal to the courts. The position to be taken is that the people's representatives never had any authority to pass such a law, and that the Governor should not have signed the same, because the people themselves had already formulated constitutional provisions that were either not

complied with or were violated,—in other words, that the act is unconstitutional. The lawyers will argue, the courts will decide, and the people will try again, and finally the road will be built.

AN IMPORTANT DECISION.

The complaint of the Broadway and Woodland companies of Cleveland, sets forth that the Brooklyn line is using their tracks between a point on Ontario Street, where the same crosses Factory Street, and the intersection of the westerly side of the Public Square and Superior Street. The Court held that the Brooklyn company occupy from Factory Street north to Superior Street. Do they occupy more than the part over which this reservation extends? Central Market is a place, not a building. It extends from Huron Street on Ontario southerly and along Woodland Avenue to Cross Street. The "Market House" stands in this place, but north of Factory Street. It is claimed by counsel for the Brooklyn company that the word "between" does not mean from the northerly limit of Central Market to the western terminus of said tracks, but from some point in Market Place to said terminus. This view we are unable to take. The word "between" as applied to space excludes the termini. This was held by the Supreme Court of Maine in a case "on all fours" with this. It follows then that to the space between the northerly limit of Central Market and Factory Street, the city not having reserved the right to compel the Kinsman company to allow other companies to use the tracks within those limits, the plaintiff is entitled to the relief prayed for, and decree will be entered accordingly.

The Brooklyn company has been somewhat relieved from its unpleasant position by an arrangement that has been made whereby it will be allowed to use the tracks until the case has been passed upon by the Supreme Court, and L. A. Russell, Esq., has already filed a motion to set aside the injunction, one of the principal grounds being that of new evidence, that was omitted by mistake. The evidence referred to is the section of the general ordinance of the city of Cleveland of date September 20, 1859, quoted on page 251 of the 36th Ohio State Report, that "any company organized for the purpose of laying down rails and running street passenger cars, to be drawn by horses or mules through the streets of Cleveland, shall be guided, governed and regulated by the conditions (therein expressed), and such restrictions as the Council may hereafter pass."

ELEVATED ROADS.

The question of rapid transit is whether population shall be huddled up in a small area, or whether that same population shall be spread out over a larger one. That the use of narrow areas, covered by a dense population, is not to be desired, is inimical to health, longevity, comfort and safety, is well known to sanitary, political and legal experts. Statistics indicate the highest death rate, the greatest crime, densest ignorance, least comfort, most expensive living, lowest morals, highest taxes, and the largest demand for police surveillance, where human beings are crowded together upon small areas.

How to reduce or mitigate these evils, has long been a study with philanthropists and municipal economists. It goes with the telling that the first duty of municipal governments or the State, is to provide by adequate legislation for the mitigation of the evils above enumerated.

The concentration of numerous business and manufacturing enterprises, requiring many thousands of people for their successful prosecution, in a few wards of the city, necessitates more wards of the city to furnish homes for the thousands employed; hence, we have this problem of Rapid Transit, or how to bring this army of employes to their work in the morning, and return them to their homes at night.

We find on investigation, that the horse railways have satisfied the demands of a population, when it does not exceed certain limits, but when that limit is passed, then comes up a cry for more rapid and more economical transit.

To enable a large part of a population to live where they can secure good air, homes at prices within their means

and yet to reach their occupation without trenching upon the time, the family, rest and recreation required, is a problem that can only be solved by the locomotive, or some motor equally swift and untiring.

It is a serious question whether it is better to build numerous towns along steam railroads entering the city within a certain radius, or retain that enterprise, capital and population within the corporate limits. That rapid transit will do this is evident to many, and it is the duty of the authorities to meet a demand, which only asks that room, air, comfort and enlarged areas be given those whose labor adds daily to the prosperity and greatness of large cities.

“RAPID TRANSIT” IN CHICAGO.”

The activity being manifested, and the interest evinced, ament street railway extensions and improvements in Chicago is almost phenomenal. The West Division Company is building some six miles of new track. The Chicago City Railway is contemplating similar extensions. The North Chicago Railway has not only contracted for greater mileage, but has secured from the City Council permission to change their main lines to the cable system, and the City Passenger Company has already begun important additions, and has acquired franchises for many more. In addition to these extensions and improvements, applications for charters and franchises have been filed for all sorts and conditions of roads—horse, cable, dummy and elevated. There is good reason for all this. No better investment can be had than in Chicago street railroads.

The rapid present growth of Chicago, its prospect for a still greater population in the near future, the plan upon which the city is laid out, and its topographical features, all demand that a better system of intramural traffic be established. Whether all the roads that now only exist on paper will ever come into actual existence is a question. Some of them perhaps will not, others we hope will. But they are needed. They will pay fairly now, largely in the future. So we say let them come, not exactly “foot horse and dragoons,” but horse, cable and elevated. But in our humble opinion the ideal Chicago street railway for carrying passengers rapidly long distances, has no existence even on paper. That it will use animal power is out of the question. That it will employ the cable system we think not. Its first requisite must be rapid transit, and this a cable road cannot give, at least a surface cable road, for no matter how well constructed, the fact remains that on the surface of a public street the maximum speed possible for a car to move with safety falls short of rapid transit. That animal traction in large cities must give way to cables or similar systems, is only a question of time. At present the cable fulfills the highest idea of short-haul intramural traffic, but for moving large numbers of people from the resident portions of the city to the business centre, the way must either be on the surface (fenced in), under the ground (arcade or tunnel), or above the ground (elevated). The “fenced in” theory is not tenable, for streets must be crossed. The arcade could not be made a commercial success for long years to come; therefore we must fall back on the elevated for our ideal Chicago railway. Suppose a central station, say on the lake front or Market Street square, or some other large conveniently located open space, and from thence an elevated way diverging north to Lake View, south to Thirty-ninth Street, and west to Fortieth Street, the sub-structure of which to be narrow, just wide enough for two trains to pass, not occupying any more space overhead than the surface tracks do on the streets below. The structure should be lattice work, strong but light, and to be supported by standards placed on the curb edge, thus avoiding interference with either sidewalk or roadway traffic,—the whole system to be under one control and management, so that trains could connect; transfer tickets be given, and one profit be made on one passenger. The cars could be well heated in winter. They would be above the dust in summer. Then a patron could enter, say at Western Avenue and Madison Street, and in ten minutes be whisked to the Market Street central station, walk across

the platform, and fifteen minutes later arrive at Fifty-ninth and Clark Streets. Such a road would be popular and its projectors be hailed as public benefactors. It would give Chicago what it most needs, namely: Rapid Transit. It would secure the passenger a seat in a warm and ventilated car. It would almost double the carrying capacity, and increase the value of rentals on the business streets through which it ran, and would largely enhance the price of contiguous resident property; as to its value as an investment, look at the New York elevated roads for an example. Other cities of the Union are moving in the matter, and railway experts recognize the elevated as the best system where rapid transit is desired; yet Chicago, celebrated for her push and enterprise, seems to be in the rear. There is wealth and honor in the project, and why some of the Fields, Armours, Kents, Leiters or Hutchinsons have not moved in this matter long before, is a source of conjecture and surprise.

STREET RAILWAY FINANCES.

The financial condition of the street railways of the country is fully considered in the last issue of *Brasstreets*. From the following table it will be seen that but seven of the thirty-nine stocks quoted are below par, and that of these four are in San Francisco, two in Boston and one in Philadelphia. Of all the lines Chicago takes the lead, and Philadelphia is a close second:

| | Per value. | Market quotation. |
|--|------------|---------------------|
| Boston— | | |
| Cambridge..... | 100 | 80-87 (March, 1886) |
| Charles River..... | 100 | 55 (Jan., 1886) |
| Highland..... | 100 | 140 (March, 1886) |
| Lynn & Boston..... | 100 | 137 (April, 1885) |
| Metropolitan..... | 50 | 83 (March, 1886) |
| Middlesex..... | 100 | 118 (March, 1886) |
| South Boston..... | 50 | 75-83 (March, 1886) |
| Philadelphia— | | |
| Citizens' (10th and 11th)..... | 50 | 250 (1885) |
| Continental (18th & 20th)..... | 50 | 123 |
| The Frandford & Southark (5th & 6th)..... | 50 | 350 |
| Germantown (4th & 8th)..... | 50 | 97 |
| Green & Coats Streets..... | 50 | 120 |
| Hestonv. Mantua & Fairmount..... | 50 | 32 |
| Lombard and South Streets..... | 25 | 50 (1885) |
| People's (Callowhill Street)..... | 25 | 39 |
| Philadelphia City (Chestnut & Walnut)..... | 50 | 135 (1885) |
| Phila. & Gray's F. (Spring & Pine)..... | 50 | 75 |
| Philadelphia Traction, Co..... | 50 | 87 |
| Ridge Avenue..... | 50 | 250 |
| Second & Third Streets..... | 50 | 200 |
| Thirteenth & Fifteenth Streets..... | 50 | 145 |
| Union..... | 50 | 170 |
| West Philadelphia (Market Street)..... | 50 | 200 |
| Baltimore— | | |
| City Passenger..... | 25 | 62 |
| Citizens..... | 25 | 25 |
| North Baltimore..... | 25 | 29 |
| Chicago— | | |
| Chicago City..... | 100 | 300 |
| West Division..... | 100 | 425 |
| North Chicago..... | 100 | 500 |
| Chicago Passenger..... | 100 | (Not known) |
| Providence..... | 100 | 202 |
| San Francisco— | | |
| Sutler Street..... | 100 | 110 |
| California..... | 100 | 103 |
| North Beach..... | 100 | 100 |
| Geary Street..... | 100 | 107 |
| Omnibus..... | 100 | 52 |
| Central..... | 100 | 14 |
| City..... | 100 | 80 |
| Clay Street..... | 100 | 50 |
| New York— | | |
| Bleecker Street & Fulton Ferry..... | 100 | 29 |
| Broadway & Seventh Avenue..... | 100 | 190 |
| Central Crostown..... | 100 | 160 |
| Central Park, N. & E. River..... | 100 | 135 |
| Christopher & Tenth Streets..... | 100 | 130 |
| Dry Dock, E. Broadway & Battery..... | 100 | 180 |
| Eighth Avenue..... | 100 | 200 |
| Forty-second & Grand Street Ferry..... | 100 | 240 |
| Houston, West Street & Pav. Ferry..... | 100 | 150 |
| Ninth Avenue..... | 100 | 130 |
| Second Avenue..... | 100 | 201 1/2 |
| Sixth Avenue..... | 100 | 200 |
| Third Avenue..... | 100 | 310 |
| Twenty-third Street..... | 100 | 230 |

DEPEW ON LABOR AND CAPITAL.

Chauncey M. Depew was the guest of the Oxford Club of Brooklyn on the evening of the 10th inst. and made a few remarks. He referred to the recent disturbances in Chicago, in which city he was at the time, and paid a tribute to the policemen who quelled them. "The trouble in that case," said Mr. Depew, "and in all other labor agitations of the last few years, is that the employés of corporations did not think of the capital which paid them as the property of nearly 30,000 people, but as a lump of money to be used merely for their enslavement. The most dangerous belief that was ever inculcated into the laborer is that corporations have no souls. Until that idea is wiped out, and the equally dangerous one that a workman is merely a mass of bone and muscle goes with it, the liberty of this country will not rest upon a sound bottom."

REGULATING THE UNIVERSE.

When the organization, known as the Knights of Labor, first announced its plans and aims, we, in common with thousands who, while not themselves actual manual laborers, are still closely allied to them in the common necessity and duty of bread-winning by toil and thought, were inspired with an enthusiastic hope, amounting to almost an assurance that here at last was the magic word that should lift the workingman out of the hard bondage of tyrannous social custom and his own selfish ignorance. We believed, as we still believe that organization is the only thing which can medicine the evils of modern society; organization for definite purposes, and those purposes education, mental and moral, with their corollary result, the amelioration of the workingman's average condition. We thought we perceived the beginning of that quiet ethical revolution which must, some day, establish the common brotherhood and mutual dependence of mankind on a footing so absolute that failure or refusal to recognize its logical consequences shall be a strange crime against law, social and moral.

Such is the noble mission which the Knights of Labor have deliberately refused to fulfil. They have, with eyes open and with the precedent of two centuries of failure before them, attempted to perpetrate on others the very injustices under which they themselves are suffering — tyranny, oppression, and making capital out of the needs of their fellowmen. It has been often said that the hardest task-masters are those who have been trained under hard task-masters. They know the possibilities of the task, and the various methods of shirking it, and possessed of this knowledge are, like traitor generals, more to be feared than those who have never passed the apprenticeship among those whom they now regard as enemies. The Knights of Labor have but given a fresh point to this bitter saying; for never in the history of modern civilization has there been a tyranny more exacting, an oppression more uncompromising, an autonomy more absolute and irresponsible, than that which this order has arrogated to itself during the past few months of its history.

It says to the workingman, on the one hand, "You shall not work for a price less than that fixed by us, nor shall you accept more than such price; you must identify yourself with and contribute to the support of our order, or we will prevent you from obtaining employment at any price in any capacity; you shall, at our bidding, refuse to work without any exercise of private judgment, whether the cause for such refusal be approved or not by you, and whether it affect your interests or not in any remote way; you shall contribute to the support of such workmen whoever, wherever and whenever, as we shall order to remain in idleness for a longer or shorter period; and you shall labor for, buy from or sell to only such persons as shall in no way come under our displeasure." To the employer it says, on the other hand, "We demand the right to make and regulate your pay-roll, both as to the number of persons employed by you and the prices to be paid them, and we also demand the right of selection or rejection of your individual employés, without personal interference from you. Failing to recognize these demands, we will close your establishment as well

as the establishments of any and all who persist in having dealings with you while under our displeasure." Such is the language of the Knights of Labor reduced to simple propositions. Where has there been, in history, assumption more arrogant, tyranny more despotic?

We are well aware of the fact that these logical conclusions are not such as the founders and wiser promoters of the order intended should be drawn from the conduct of their organization, but history has only repeated itself when ignorant numbers override the calmer judgment of the few wiser counselors. A half dozen successful movements—successful, in most instances, because they were just—have made the mob drunk with a sense of power, and unjust demands and untempered efforts follow in quick succession, as the natural result of anarchy following the overthrow of established law.

But we see little to fear in this intemperance, though there is, alas, much to regret. Society—order-loving and intelligent society—will not long permit such crying abuse of visionary power, and ere long the unjust strike and the fiendish (we use the word deliberately) boycott will have become mere historical words. But the workingman: Well, he has conjured up a Frankenstein, and nothing but the mercy of Heaven can prevent its throttling him and remanding him once more to bondage under the tyranny of a cruel social law—the law of supply and demand; and of placing the wished-for advent of the more benignant era of charity and universal brotherhood sadly far in the unknown future.

Mr. Gould is correct: "It is a fairly good-sized job to rule and regulate the universe," and tyranny can only succeed in wrecking its own machinery.

"CHEVALIER D'INDUSTRIE."

The knights of the present day bear little resemblance to the soldiers, clad in armor, who in mediæval times rode to battle and to glory. These military gentlemen were appointed by the sovereign. They never were accused of indulging in manual labor, nor any labor whatever, except that that was incidental to danger and adventure. They formed a portion of the nobility of the day. They had little sympathy with the toiling millions. The most celebrated order of Knighthood was instituted by King Arthur, and the exploits and adventures of that body of men were the subject of many ballads, as well as the basis of much of the early romantic poetry of England.

Notwithstanding these historic facts, criminals who have been convicted of giving false evidence on trials, or false bail, have been called knights of the *post*. How it occurred that this honored word and title came to describe such ignoble persons is not known. This would be quite an interesting subject to investigate. In this country that portion of our fellow citizens who are laborers, in all fields of industry, dub themselves knights. A Frenchman, in writing on the subject of our labor troubles, has fallen into an amusing mistake. In his language, *chevalier d'industrie* means a low swindler and rogue, who never labors; and as the words Knights of Labor very nearly corresponds with the French words already quoted, the writer assumed that the people who have been lately so aggressive in America, were a lot of lawless criminals who were trying to overturn society and to destroy all government. It can easily be imagined what fantastic and strange conclusions the Frenchman arrived at. It is never safe literally to translate any language.

Whatever may be our opinion of the labor organizations of the United States, or of the few bad men and political agitators who control them, certainly no one ought seriously to accuse the Knights of Labor of belonging to the class known in France as *chevalier d'industrie*.

Horse railroad strikes are getting to be a knotty question when it comes to tying up cars.

The aldermen work as readily by cable as by horse power. But the roads are underground, not surface.—*N. Y. Tribune*.

A PREDICTION.

Dr. Talmage, in his second lecture on the present labor trouble, said:

"Labor agitation will soon cease. The mills and railroad traffic are bound to resume at an early day, but the damage done to business and to themselves cannot be repaired immediately. One hundred million dollars has been diverted into new channels or placed temporarily under lock and key. Wages will not be so high as they have been. Here and there and now and then they may rise, but they are bound to drop lower. Strikes, whether right or wrong, always injure the laborers more than the capitalists. You will see this in starvation among the wage workers next winter. Boycotting and violence are like murder, and God never blessed murder. The poorest use you can put a man to is to kill him. Blow up to-morrow all the country seats on the banks of the Hudson and all the fine houses on Madison Square and Brooklyn Heights and Brooklyn Hill and Rittenhouse Square and Beacon Street, and all the bricks and timbers and stone will just fall back on the bare head of American Labor."

STREET CAR ETIQUETTE.

It is quite evident that there is a retrogressive evolution if such a thing is not a contradiction in terms, in American manners as illustrated in public conveyances. When we were younger the accepted ethics of gallantry demanded that all courtesy should be shown to a female wherever encountered. This day has passed. If anyone doubts this let him observe the treatment of woman in the street cars of our cities. A lady enters. There are no empty seats. There are a number of males, both old and young, sitting. No one moves. The lady stands until there is a vacant seat, and then the gentlemen accord the courtesy of it to her. It is not a usual thing for a male to rise from his seat in order to offer it to a female. When this does happen, however, it is very apt to be on the part of a gentleman of the old school, and generally one who has been a member of the "silver greys" so long that a young woman should not really accept the tendered compliment.

But gentlemen do sometimes offer their seats to ladies. Do they always acknowledge the favor? Does a young female ever offer her seat to an old man or woman, or to a woman with a child in her arms?

We could read a long lecture to the small boy. Outside of the trouble he causes the conductor in looking after him, in assisting him in getting on and off the cars, he is generally lacking in good manners. It is quite a rare thing to see a boy offer his seat to a lady or to an old gentleman. Messenger boys and all manner of "small fry," have no respect for sex or age. This is the fault of the want of proper education and instruction of the youth of this country. It does seem that the decline in good manners in public conveyances marks a more universal deterioration in habits of politeness that is going on in society.

THE PROGRESS OF THE WORKING CLASS.

Some years ago a few political agitators organized a movement in one of the states of the Union, and they were successful in taking possession of the local, and even threatened to capture the central Government itself. The complaint that seemed to lie at the base of the philosophy of these leaders was that the rich were rolling up untold wealth, and that the poor were in a worse condition than ever before in the history of the world. If this statement, that constitutes the whole gist of the argument, and the soul of the entire complaint was proven to be incorrect, then the superstructure reared upon this foundation must fall, for no matter how popular and successful a movement may become, still if it is not based upon sound economical truth, it must eventually fail. Before a party can possibly attain a lasting success it must enunciate political truths. It must then grow in numbers and influence. Until this is accomplished, there is nothing but the suggestion of a theory by a few. It is not intended to discourage the presentation of as many theories as may occur to inquisitive and daring minds, but

on the contrary it is believed that the investigation of all subjects leads to a crystallization of thought that, at last, takes such form as the society and the civilization of the day demands.

The statement that the "poor are growing poorer" is shown to be untrue by the best informed statistical writers, who have laboriously collated all the facts upon this burning question. In England, the statistics on this subject are more complete than in this country. The records clearly show in that country that the money earnings of the masses have increased, while the hours of labor have diminished about twenty per cent. There has been a shortening of the hours of labor in the textile, engineering and house-building trades. The astounding result arrived at is that the workman gets from fifty to one hundred per cent. more money for twenty per cent less work, in other words he has gained from seventy to one hundred and twenty per cent. in fifty years, in money return. It may be noticed that houses are of greater value than fifty years ago, and necessarily more rent is paid, because more capital is invested in this kind of property. The saw-mill has given us wooden floors, the manufacturer of glass, windows; and chimneys now purify the atmosphere of our dwellings. Pavements, drains, sewers, the lighting of the streets and street railways have improved the condition of the people. Ice-houses are constructed, and carpets now replace the straw that had served as a covering for the floor. Great benefits have been worked out for the human race in the improvements in implements for plowing, sowing, mowing, reaping and thrashing. Opposition was made for a long time to insurance companies, because it was claimed that they interfered with the workings of Providence. Vaccination and the use of anæsthetics have improved the health and general condition of the masses. The diffusion of reading and writing, the existence of free libraries, the public school, the daily world's history—the newspaper, the post-office, the establishing of hospitals, the improved prisons, the treatment of lunatics, the construction of canals, sanitary engineering, census reports, the cotton gin, cotton mills which gives us cheap clothing, the advancement in medicine, surgery and the fine arts, of agriculture, of rural economy, of farm machinery and the manufacture of iron all contribute to the well-being of the people. The railway that annihilates space must not be forgotten.

Statistics show us that science through all these mediums has prolonged human life from an average of 22 to 41 years. The world commenced to call together from its remotest quarters the result of all these great achievements and to place them from time to time in those grand depositories, the industrial expositions. When we look around us at all this activity, we are almost led to believe that the world was resting itself during mediæval times for this grand present.

When all the benefits that have flowed out to the human race, in recent times, are coupled with a continuous reduction in the hours of labors, and with an increase in the earning per hour, the conclusion is irresistible that the people of all classes and conditions are now better fed, clothed and instructed, and are happier than they were in the past.

It is curious how much faster a street-car goes when you are running for it than it does when you are riding on it.—*Chicago Tribune.*

"Conductah!" she called in a languid voice.

"Yes'm."

"Can you stop the cah?"

"Yes'm."

"Then you may stop it."

"Yes'm," he said, as he rang the bell.

"Conductah," she called, as she looked out of the window.

"Yes'm."

"Can you start this cah?"

"Certainly."

"Then you may start it. I believe I will ride to the connah. When I reach the connah you may stop it."—*Detroit Free Press.*

AROUND THE BARNs.

NO. I.—CLEVELAND, O.

When visiting the Forest City, a short time ago, the writer accepted the invitation of Mr. J. B. Hanna, secretary of the Woodland Ave. West Side Railroad to visit the West Cleveland barns of that company, and one bright afternoon we were bowling along, behind a daisy little trotter, up Detroit Street. We soon reach the barns which are located about a couple of miles from the head office of the company, and stand back from the road some twenty-five feet, the gap being filled up with grass plots, flower beds, etc. On entering the main building one is impressed with the feeling that no limit was placed upon the amount of ground covered. The building is a two-story brick and frame, resting securely on a foundation of solid Berea stone. The main or first floor is subdivided into stalls 6' x 9' each, furnishing accommodations for one hundred and twenty-five horses. A cast iron gutter runs the entire length of the barn, at the entrance to the stalls, connecting directly with the sewer every 30 feet, to permit of easy flushing. Shavings are used exclusively in the stalls, the company finding them most economical and cleanly. The width of the center aisle is 12 feet, that of the side ditto, 6 feet, and 3 feet is allowed for feed-space. Horses are fed seven times per diem; three times with a mixture of $\frac{2}{3}$ corn and $\frac{1}{3}$ oats, and 4 times with loose hay. From the splendid appearance of the stock it would seem as though the diet agreed well with them. Thirty new horses have recently been added to the company's stock.

The basement—84' long x 30' wide—is as cool as a wine-cellar, and is utilized as a hospital for sick horses. A drop of 12 feet in the 175 feet (length over all) gives perfect drainage. About every 20 feet, on the outside, between the foundation proper and the building, are air-holes, and the floor of the stalls comes about 5 inches above so that a current of pure air is constantly circulating below the level. The "stables" contain three large shafts (wood) 6' x 3' leading upward, and projecting 6' above the roof, thus ensuring the most admirable system of ventilation.

The upper floor is used as a feed and store-room, and commands a fine view of the lake.

West of this building, some 20 or 30 feet is located the car-house, a two-story brick and frame structure 65' x 175'; four tracks are laid, connected by a transfer-table patented by Mr. Chas. Hathaway, of this city. A well-protected oil-room, 8' x 10' occupies one corner of the car-house. The space overhead—which does not run the entire length of the building—is to be fitted up as a drivers' room. One great convenience in the car-house is a wash-pit, 30 feet long, 8 feet wide and 4 feet deep, with direct sewer connections.

In the rear of the barns is the blacksmith-shop, a solid brick building, 15' x 30', also a "bit o' pasture," 50' x 30'. The company also rent some twenty-five acres of pasturage on a farm, two miles and a half from the barns, and about ten car-horses were enjoying their liberty when the writer "happened along their way."

The company have a complete double equipment of cars—about seventy box, built in different parts of the country, and seventy open. They recently completed the construction of seven new cars, and, from all appearances, are "hard to beat."

About seven miles of the line are being entirely relaid with forty-five pound steel rails, of the side bearing pattern, made by the Cleveland Rolling Mill Co.

It is a noteworthy fact that the Woodland Avenue and West Side Street Railroad Company has, for fifteen months past, been working its men only eleven and a half hours a day (including meals and lay over) thus anticipating the recent order of the city council, constituting twelve hours a day's work, and it was also the first company to raise the wages of its conductors and drivers this spring.

The present highly satisfactory state of the company's finances shows conclusively that liberality not only pays, but that the public is quick to appreciate it. The late lamented Mr. Sims, in whose hands the road originally was,

held that whatever was good enough for workmen to ride in was good enough for princes, but constant complaints, and a steadily decreasing exchequer proved the fallacy of his plausible argument. At that time Mr. Mark Hanna was interested, jointly with Mr. Sims, but he bitterly opposed the suicidal policy inaugurated by the latter named gentleman, and eventually brought matters to a crisis by suggesting to Mr. Sims that each should make a proposition to buy the other out, which was done, Mr. Hanna obtaining the control of the road. He immediately went to work to remedy the evil caused by gross depreciation in the rolling and other stock, declared no dividends for a considerable time, but invested all surplus funds in betterments, bought new horses, laid new track, replaced the old fever-boxes with good, substantial cars of approved patterns, and the result to-day fully bears out the wisdom of such policy. The road would have become a thing that was, but prompt action saved it, and as between the judgments of the two gentlemen aforesaid, we may be pardoned for believing in the Darwinian theory of the "Survival of the fittest."

STREET-CAR PROPULSION IN GREAT BRITAIN.

In Great Britain the expense of horse feed is much higher than it is in America, so that the expense of operating street-railways with horses reaches very high. Efforts have constantly been made for years to introduce a cheaper motive-power, but this far without success. Steam motors have had a limited application, but the municipal boards object to having them in the public streets, so their use is obstructed by annoying ordinances. When the Portrush Electric Tramway was opened in Ireland two years ago, it was expected that the experience gained in the actual operation of that road would lead the way to operating ordinary street-ways by electricity, but nothing has come of it. The application of electricity to car propulsion, says the *National Car-Builder*, is recognized as being still in the experimental stage and capitalists will not put money into experimental schemes that promise so little financial return. In Manchester, there has lately been considerable agitation in favor of introducing the cable system of street-car propulsion. The practical success of this system in San Francisco and Chicago is cited as good reason why it should be introduced in Manchester.

The Manchester engineering world has been familiar with cable traction almost since this century began, and it is surprising that it has not been tried more for street-car traction. If we remember rightly, the Blackwell Railway in London was first opened as a cable road some fifty years ago or more. That was a failure, principally through defects in the mechanical details, and the loss incurred by the promoters of the enterprise may have deterred others from entering into similar schemes.—*American Railroad Journal*.

A suit for damages brought by a woman against a railroad company on account of "the nuisance of indecent language and conduct of certain unknown strangers who proved disorderly in the presence of the plaintiff while she was seated in the ladies' waiting-room of the defendant's railroad."

The court decided that the action could not be maintained. It admitted that the legal status of the plaintiff was that of a passenger, for she had bought her ticket, and was waiting for the train; and that railroad companies are bound "to use the utmost care in protecting passengers, and especially female passengers, not only from the violence and rudeness of its own officers and agents, but also of intruders who are strangers." But this general principle was qualified by the statement that the wrong or injury done the passenger must be such that it may reasonably be anticipated or naturally expected to occur.

"We do not think," the court then said, "that there is any duty to police station houses with the view of anticipating violence to passengers which there are no reasonable grounds to expect. There is nothing tending to prove that in this case the company had notice of any facts which justified the expectation of such a wanton and unusual outrage to passengers."

PERSONALS.

MR. C. W. RUSSELL.

Mr. C. W. Russell, of the Goodenough Company, was one of our recent callers.

C. W. CANNON.

Mr. C. W. Cannon, President of the Helena Street Railway Company, has recently been in Chicago in the interest of his road. We understand that "Charley" Pullman chaperoned him, and he was therefore kept out of danger and mischief.

GEORGE W. HAMILTON.

Mr. Geo. W. Hamilton, master mechanic of the Camhria Iron Works, has been in town.

JOHN TOWNSEND.

Mr. John Townsend, Secretary of the Johnson Steel Street Rail Company, visited the city of Chicago on business.

JOHN HARRIS.

The house of Mr. John Harris, Superintendent of the Consolidated Street Railway, of Cincinnati, situated on the green slope of Price Hill, was filled with a gay throng of friends of the clever host and employes of the company, who had assembled in response to an engraved card reading: "1861-1886. Mr. and Mrs. John Harris, at home Friday evening, May 28, at 8 o'clock. Twenty-fifth anniversary. 610 State avenue," accompanying which was a neat card, "Miss May Harris, eighteenth anniversary."

Shortly after 9 o'clock the strains of an approaching brass band announced another surprise, and soon the flaring torches of a large party of the employes of the company, preceded by a large wagon with a mysterious burden, hove in sight, and came to a halt before the house. Two or three stalwart men carefully lifted the load from the wagon, carried it in, and deposited it in a corner of the parlor. When it was uncovered it proved to be a handsome black-walnut book-case, with heavy plate glass doors and cylinder desk, within the latter being an elegant cut-glass double inkstand, on which lay a gold pen. On the lid was the inscription graven on silver, "Presented by the Employes of the Avenue and Brighton Division Cincinnati Street Railway Company, to John Harris, in Remembrance of the Twenty-fifth Anniversary of His Wedding." Mr. Enoch Kennedy made the presentation speech, and Mr. Harris responded in a few happy words, and inviting all the men to make themselves at home. On a table in the drawing-room lay a number of elegant silver presents. The stable foreman sent a handsome water set, consisting of beautifully chased pitcher, salver, bowl and two goblets, while other friends sent a number of appropriate and useful articles.

MR. HAZZARD.

The Brooklyn City Railroad will probably retain Mr. Hazzard as its president. His tendered resignation has not been acted upon by the Board of Directors, and Mr. Hazzard states that he is willing to remain president if he can feel that he has the approval and hearty co-operation of the board.

It is with pleasure we give space to the following self-explanatory official notice:

CHICAGO & GRAND TRUNK R'Y.
DETROIT, GRAND HAVEN & MILWAUKEE R'Y.
TRAFFIC MANAGER'S OFFICE.

CHICAGO, MAY 24th, 1886.

NOTICE:— Taking effect on the first of June Mr. W. E. Davis will be appointed General Passenger and Ticket Agent of these lines with headquarters at Chicago.

Geo. B. REEVE, Traffic Manager.

APPROVED:
W. J. SPICER, Gen. Manager.

[THE STREET RAILWAY GAZETTE desires to extend congratulations on this deserved recognition of valuable services.]

POINTERS.

NOTICE.

These pointers are specially compiled for "THE GAZETTE" from data furnished by the roads or by our local or traveling agents.

Contemporaries republishing same, either whole or in part, please give us due credit.

ALABAMA.

Birmingham.

The dummy engines for the Elyton Land Co.'s Boulevard street railway have been received and are about ready to run. The line, recently completed, traverses the length of the Highlands and connects that fine suburb with the business center of the town. Lakeview Park is a prominent point on the route. It is now furnished with a first-class restaurant, a commodious swimming bath, new boats on the lake and cottages for summer residence.

Montgomery.

The Capital City Street Railway of Montgomery, Ala., has at last made a final contract for the equipping of their entire line with the Van Depoele Electric Railway system, and the name of their company has been changed to the Capital City Electric Street Railway. The Montgomery people are more than pleased with the preliminary test made by the Van Depoele Electric Manufacturing Company under the most trying circumstances.

Tuscaloosa.

A street railway is being organized in this city.

CALIFORNIA.

Los Angeles.

A franchise for an electric street railway, in this city, has been granted to C. H. Howland. Arrangements have nearly been completed to consolidate the five horse railroads of this city.

San Jose.

Consolidation is the order of the day and the horse railways of this place will soon be brought under one management.

San Francisco.

A gentleman in San Francisco offered a horse-car conductor a \$5 gold piece in payment for his fare. The conductor could not make change, and demanded the exact fare—5 cents. The gentleman had no other coin and was expelled from the car. This was done so forcibly that he was made sick for four days. He brought suit for \$500 and got it, the court holding that under the circumstances \$5 was not an unreasonable amount to tender in payment of fare in the absence of any regulation by the company to the contrary.

The Hayes Valley branch of the Market street Cable Railway is fast nearing completion. The track is completely laid and paved from Lott street to Market. The engine house is finished and the powerful machinery which will be required to run the cable is expected at any day to be put in its place. The switch at the junction of Market and Hayes streets is one of the finest pieces of workmanship of the kind ever accomplished in the world. The entire road-bed is made of iron, and the walls, within which a gigantic cast-iron wheel will revolve, is constructed entirely of brick. The switch alone when completed will cost the company about \$15,000.

The cars are being constructed at the works of the Central Pacific at Sacramento. They will be like those in use on the other branches of the road, except that numerous improvements which experience has found necessary will be added. The cars will be painted a dark green, with lights of the same color. It is expected that the road will be in running order by July 1.

Work will then be commenced on the Castro street road. This line will take the place of the present steam dummy road out Market street beyond Valencia. It will extend out Market street to Castro, and along that thoroughfare to Twenty-ninth street. Castro street has been graded along the line of the proposed road and every thing is in readiness for the work to begin.

When the road is built it will greatly enhance the value of property in the neighborhood of the Twin peaks. At present the residents of this section have to walk over the hills for at least a mile before they can board a car.

COLORADO.

Denver.

The Denver Tramway Company has been incorporated by R. Curtis and others. Capital stock, \$500,000.

DISTRICT OF COLUMBIA.

Washington.

THE CABLE-ROAD QUESTION.—Several companies organized to lay cable railroads in the Capital have pooled their issues and will try to obtain a common charter from Congress. The scheme of service embraced in the new plans is comprehensive, covering a large part of the city, which is now poorly provided with means of transit. On all but the Pennsylvania avenue line the passengers have to pass up their five-cent fares, as there are no conductors. Senator Van Wyck occasionally slips up the street-car corporations by charging that they own a good many Congressmen. The District Commissioners oppose cable cars, and the property-owners are, as usual, divided. The Senate and House Committees which have control of the subject are hearing arguments pro and con, so that all the advantages and drawbacks of the cable system are brought out.

FLORIDA.

Jacksonville.

The Belt Railroad Company, of this city has been organized to build a street railway three miles in length.

Orlando.

A street railway company has been incorporated at this place, by W. S. Copeland, N. Poyntz and others. The line will be about ten miles long. Capital stock, \$50,000.

GEORGIA.

Atlanta.

A NEW USE FOR STREET RAILWAYS.—The Metropolitan Street-Car Company, of Atlanta, Ga., is breaking a lot of Texas ponies by making them pull street-cars. This is an excellent way to break bucking ponies, and it also affords infinite amusement to the passengers. A passenger gets aboard of the car, and is not in any particular hurry about arriving at his destination; a regular Mazeppian steed is hitched to the car, and all along the line there are stoppages and lots of fun. All this any citizen can get for the small amount of five cents. This company will extend its line to Grant's Park.

Athens.

The street railway bonds which were once thought worthless, have recently been selling at 95 cents on the dollar.

Macon.

President Brnsford, of the Macon Street Railway Company, intends to double track the road where practicable, and to build more turnouts on the single track portions.

A street-railway has been opened from this city to East Macon, and the line will soon be extended to Gilesville, making a four-mile run.

ILLINOIS.

Cairo.

The Commercial Avenue Street Railway Company, of this place has been incorporated by Dennis J. Foley, John M. Lansden and Angus Lek. Capital stock, \$10,000.

Chicago.

The West Side Railway Company is about to put in corner-curves down-town so as to enable their cars to keep in motion continually and thus avoid the inconvenience resulting from their standing on State, Randolph and Lake streets. The South Side company, which controls the right of way on the streets which are to be used, does not offer any opposition, and the changing in running is, therefore, only a matter of a few weeks. One curve has already been put in at Lake and State streets, and another will be put in at once at Fifth avenue and Madison.

The company will not have to go to the Council, as it can do all that is required under its present ordinance.

The work of connecting the track of the Chicago Passenger Railway Company on Adams street is completed. The switchback on Michigan avenue is just in front of the Brooks estate, about seventy or eighty feet south of Monroe street. The loop, when completed, will extend west on Washington to Franklin and thence south to Adams street.

The petition now being circulated for the signatures of property owners favorable to the scheme of constructing a double line of track along Dearborn from Folk street to the river has met with such favor that the consent of owners to the extent of 3,500 feet over the requisite one-half has already been secured. The next move to be made by the promoters will be in procuring the necessary franchise from the Council, and it is thought this will be done within the next two weeks. Every signature on the petition as yet is that of a property-owner, as none of the leaseholders have been approached in the matter. The work of laying the track will be commenced directly after the franchise is granted, but pending this the organization of the company will be perfected. The proposition is for the property-holders themselves to build the line and then lease it on the most favorable terms that can be made.

The City Railway Company has paid \$13,880 for 132 feet on Wabash avenue near Fifty-second street.

The Fourteenth Ward German Improvement Association met at Schonhofen's Hall last night and appointed Messrs. Dore, Fred Foltz and August Hildebrandt a committee to confer with the two West Side street-car companies with reference to laying tracks on Division street from Milwaukee avenue to the North Side, across Goose Island. The North Side company declared its willingness a few years ago to lay tracks to connect with those of the West Side at the bridge, but the new management has not yet been approached on the subject. Tracks are being laid on Division street, west of Milwaukee avenue. If the old West Side company is not willing to extend its line to the river and across Goose Island the committee was instructed to confer with the new railway. The idea is that transfer tickets be given, making but one fare necessary to carry a passenger from Clark street to Western avenue, so that the long-desired connection between the North and West Sides be established. Such a line would also relieve the Milwaukee avenue line. It was stated that the new company was at present more favorably disposed to the project than the old one.

The City Council passed the ordinance authorizing the North Side cable cars, and the proposition to give the road the use of LaSalle street tunnel was referred to the committee on railroads.

Evanston.

A street railway company has been incorporated in this city, with a capital of \$150,000 to operate lines by horse and cable traction.

Hyde Park.

The South Chicago Street Railway Company has been granted an extension of time for the construction of the road.

Lawndale.

For some time back the people of Lawndale have been trying to get the West Side Street Railway Company to extend its Ogden avenue tracks to that point. Failing in their efforts to induce the company to do it, they sought redress in the court, and finally began proceedings to deprive the company of its right to lay tracks on Ogden avenue west of Western avenue, on the ground that it had failed to extend them to Lawndale. The Lawndale folks were beaten in the lower court and carried the matter up to the Supreme Court, where a decision was given on May 15th, sustaining the company, and thus depriving the people of all hope of an extension of the road until the company builds it of its own motion.

Springfield.

The following corporations have been licensed by the Secretary of State: The Chicago Electric Elevated Railway; to build a line from some central point in Chicago to Hyde Park, South Chicago, Pullman, Union Stock Yards, Englewood, Blue Island, Riverside, Lemont, Washington Heights, Lagrange, Western Springs, Riverside, Oak Park, Hinsdale, Brighton Park, Central Park, Garfield, Barrington, River Park, Evanston, Maywood, Jefferson and Lake View; capital stock, \$5,000,000; incorporators, E. B. Payne, Enoch Slosson and A. B. Graham.

* *

INDIANA.

Elkhart.

The Citizens' Street Railway of this place has received a franchise. The Knights of Labor secured a clause requiring hours and wages to be agreed upon by an arbitrator.

Logansport.

The street car company at Logansport has petitioned the council to pass an ordinance granting them the exclusive privilege of utilizing electricity or hot air in propelling their cars through the streets.

* *

IOWA.

Des Moines.

A movement is on foot at Des Moines to substitute electricity in place of horse power on one of the city railways.

* *

KANSAS.

Leavenworth.

There is a movement on foot to build a cable railroad from the Soldiers' Home to Fort Leavenworth, in Leavenworth, Kan. The distance is six miles.

* *

KENTUCKY.

Falls City.

The City Street Railway Company has been organized in this place by A. Strauss and others.

Louisville.

The Enterprise Street Railway Company of this city has been incorporated. Capital, \$100,000.

* *

MAINE.

Portland.

The New England Electric Railway Supply Company of Portland, Me., has been incorporated with \$200,000 capital stock.

* *

MASSACHUSETTS.

Amesbury.

The Amesbury Horse Railway Company was sued by E. G. Kelly, contractor, for \$9,154.04, which was the face of the promissory notes, and which the company did not expect to pay because fifty per cent. of the par value of each share of its capital stock had not in fact been paid in; but the court has decided that a street railroad corporation which has duly filed the certificate required by the statute of 1871, chapter 381, Sec. 6, stating that the amount of its capital stock has been unconditionally subscribed for by responsible parties, and that fifty per cent. of the par value of each share thereof has been actually paid in cash, cannot escape liability for the payment of its debts for the building of its road, on the ground that the construction of its road was contracted for and commenced before this cash was paid or subscribed, so that an execution issues to the contractors if the notes are not paid.

Boston.

The Street Railway Committee of the Massachusetts Legislature, that visited New York in the latter part of May, is said to have been highly pleased with the motor tests it saw here, Rumor has it that a report will be made in favor of an elevated electrical railway with one row of posts.

The Boston Elevated Road Company, with \$10,000,000 to work upon, solicits from the legislature the authority to build with electric motors a belt line from the Lowell Station along Causeway street and Atlantic avenue to the old Colony, and thence across to the Providence, and through Charles street back to the start. The company is to deposit \$1,000,000 of its stock as a guarantee for all liabilities. The road is to have power to lease, unite, consolidate, connect or make traffic arrangements with any other line of railway, now or hereafter in operation, in the counties of Suffolk, Middlesex, Essex or Norfolk. The maximum rate of fare is ten cents, though special rates less than ten cents during certain hours may be made. The road is to pay Boston five per cent. of its net earnings to support and embellish the city parks. It is said that 124,800 suburban dwellers go in and out of Boston daily, and that there is an increase from year to year of twenty per cent.

The Meigs Elevated Railway was operated on April 16th for the first time. The train, consisting of engine, tender and passenger car, took the fifty-foot curve and surmounted the 345-foot grade without difficulty. A legislative committee witnessed the trip.

Cambridge.

The Cambridge Horse Railroad raises the wages paid, and also the fare from five to six cents; but the Fall River Company advances the pay under less promising conditions of business and profit, and reduces the fare from six to five cents.

Fall River.

The Globe Street Railway Company has been granted a location on several streets, the tracks to be laid within five months and the paving to be of granite.

Fitchburg.

A street railway has been incorporated at this place by Elijah Parker and others, with a capital of \$60,000.

Lawrence.

Fifty-five tons of steel rails have been purchased by the Lawrence (Mass.) Horse Railroad Company, and will be laid between the Durbuck bridge and North Andover.

Lynn.

The Lynn & Boston Horse Railroad Company contemplates building its tracks this summer to Malden.

Malden.

The Horse Railway of this place will lay a double track between Malden and Charlestown.

North Adams.

The North Adams Horse Railway, running five miles to Adams along the Hoosac Valley, is to be surveyed and building decided at a cost of \$10,000 a mile. The company was incorporated by T. P. Thayer and others. Capital, \$50,000.

Ties, steel rails, two motors and four passenger cars have been contracted for.

Newbury.

The franchise for the North Water street extension of the proposed street railway has been sold at auction to the Newbury Street Railway company for a tenth of one per cent. of the gross receipts on that division.

Pittsfield.

A street railway company has been incorporated in this town by T. Clapp, T. L. Allen and others. Capital stock, \$50,000. The survey has been made, and Mr. Guilds, one of the Boston directors, will reside in Pittsfield to superintend the construction.

The cab company's business has been purchased by J. M. Sullivan for \$2,500, and it is thought it may be consolidated with the street car company.

Plymouth.

At a meeting of the new Plymouth & Kingston Street Railway Company the following board was chosen: President, James D. Thurber; Directors, Leavitt T. Robbins, J. H. Weeks, A. L. Gordon, C. Holmes, A. T. Holmes and Charles A. Floyd. Capital, \$20,000.

Salem.

The new branch of the Naumkeag Street Railway to Wenham has been opened, and a new car house and a stable, each 100x40 feet, have been built. Chas. O. Putnam will be division superintendent.

An extension of the tracks of the Salem & Danvers Horse Railroad from Danversport to Asbury Grove, via East Danvers and North Beverly, is projected. The proposed route would bring Danvers, Peabody and Lynn nearly two miles nearer to Asbury Grove than by any other route, and cut off the steam railway travel to this famous camp ground.

Sloveham.

The street railway company here recently discharged a driver for running his car off the track. At a meeting of 1,500 Knights of Labor held on the evening of the 21st ult., all voted to boycott the street cars. The Knights who work in Boston walk two miles to the depot. They threaten to put on stages.

Worcester.

A contract for the street railway in this city has been let to F. S. Stevens, of Cambridge. The West Side and Quinsigamond lines are to be completed by July 15.

.

MINNESOTA.

Mankato.

The street railway of this place has ordered its new cars to be delivered June 1.

Minneapolis.

The Minneapolis Street Railway Company will build ten miles of street railway, forty cars, and add 350 horses to their equipment, to cost over \$175,000.

Stillwater.

The Stillwater street railway company has been incorporated by S. Matthews and others, with a capital of \$100,600.

Stoux Falls.

A street railway is projected.

St. Paul.

At a recent meeting of the Canal Committee on Streets, many objections were urged against the operation of a motor line on Grand and Oakland avenues. The committee finally reported in favor of giving permission to make tests of the noiseless motor.

.

MICHIGAN.

Detroit.

The Highland Park Railway Company has been incorporated to build an electric line from the Woodward avenue street railway to the exposition grounds. W. A. Jackson, McMillan Building, Detroit, is interested.

An electric street railway is to be built to Springwells.

Kalamazoo.

A bonus of \$2,000 has been subscribed for the construction of a new street railway in this town.

Lake Linden.

Ten thousand dollars has been raised at this place toward a new street railway.

.

MISSOURI.

Kansas City.

The Grand Avenue Railway Company of this city will build several lines of cable track. President, W. J. Smith; engineers, Knight and Bontecou.

The Kansas City and Rosedale Street Railroad is to be put into the hands of a receiver until the difficulties with the directors are adjusted.

A double track street railway three and a-half miles long is projected. Cable or elevator power will be used, but there has been some doubt as to the efficiency of the electric motor on the heavy grade. John B. Stone, Henry N. Smith and others are the incorporators.

St. Louis.

The Brownell & Wright Car Company has turned out forty bob-tail cars for the Union street car line.

MONTANA.

Helena.

The Helena Street Railway Company has been incorporated, with a capital stock of \$100,000. This road will immediately be operated two and a-half miles, but it will soon be extended to the Springs and the Fair Grounds. The Johnson rail will be used, with a gauge of four feet eight and a-half inches. The cars will be built by the Pullman Company, and will be exactly similar to those now in use in Broadway, New York. They will be finished in mahogany, with all the modern attachments. The following officers of the company were elected: President, C. W. Cannon; Vice President, J. B. Wilson; Secretary and Treasurer, L. A. Parker; Directors, C. A. Broadwater, H. M. Marchen, A. M. Holter, C. W. Cannon, L. A. Walker, J. B. Wilson and A. J. Selligman.

.

NEBRASKA.

Omaha.

The stockholders of the Omaha Cable Tramway Company, on the 13th inst., passed a resolution to build two miles of road at once, and construct a power building.

.

NEW HAMPSHIRE.

Manchester.

The Manchester Horse Railway Company has elected the following board: President, Samuel N. Bell; Treasurer, Hon. Fred Smyth; Directors, Joseph B. Clark, James A. Weston and Josiah Carpenter. The Central street extension is not yet decided on.

Nashua.

The new street railway was opened May 16, and the line has since been extended to the Concord R. R. depot.

.

NEW JERSEY.

Bridgeton.

Oberlin Smith is among those interested in a street railway of this place.

Elizabeth.

The Elizabeth and Newark Horse Railroad Company will build a line from the Lyons Farm branch to Mount Olivet Cemetery.

New Brunswick.

The aldermen of this city have had a sudden attack of enterprise, and have recently granted franchises to several newly organized street railway companies.

Plainfield.

A New York syndicate proposes to build a horse car line. Messrs. Charles and James Raymond, contractors, Brooklyn, have been prospecting for the route which is to embrace all parts of the city where traffic may be depended upon. The company is the same that has the franchise for a street railway in New Brunswick.

Princeton.

It is said that a street railway from the court house to the depot would be a paying concern.

.

NEW YORK.

Albany.

The Assembly has passed the bill providing that with the consent of half the property owners, any horse street railway company may convert its line to the cable system.

The Albany Railway Company has increased the salaries of its employes; conductors, 15 cents per hour; fare-box conductors, 16 cents per hour; drivers, 15 cents per hour; inspector (at office) \$1.35 per day; (on lines) 13 cents per hour; hostlers, \$9.10 per week; night foremen, \$10.50 per week; day foreman, \$12.25 per week; changers, washers and watchmen, \$9.10 per week; carpenters, \$2.50 per day; track foremen, \$2.50 per day; master mechanic, \$3.00 per day.

Brooklyn.

One obstacle that has stood in the way of rapid transit in Brooklyn is about to be removed. Governor Hill has agreed to sign the act repealing the "compensation law," the enactment of

which Mayor Low secured, and the wisdom of which was soon made apparent. It compelled companies proposing to build elevated roads to give bonds to cover the possible damages resulting therefrom. It did not take long to show that this law was not needed, and that it was a substantial hindrance to the city's development in this direction.

Conformably to the request of the Rapid Transit Commission for Atlantic Avenue, Colonel Culyer has submitted specifications for the construction of an elevated railway from the South Ferry to the city line. It seems plain that this elevated railroad on Atlantic avenue ought to accomplish three ends: 1. The removal of steam from the surface of the avenue; 2. The supply of a central line of rapid transit for Brooklyn, and, 3. increased ease of communication between this city and all parts of Long Island. The third can be accomplished without bringing Long Island trains into the heart of the city, and there would be no objection from Brooklynites if the company concluded to have its depot at East New York instead of where it is now. But if it is to reserve the right to run through trains on the avenue, it must provide tracks to carry them. Brooklyn cannot afford to sacrifice the facilities of local transit for the convenience of people who want to go to Coney Island, to Babylon or to Greenport.

The Brooklyn Elevated Railroad celebrated its first anniversary on May 13th. The prospects of the road are improving.

The Brooklyn City Railroad have decided to erect new stables for the Third Avenue Division of the road, at the corner of Third avenue and Twenty-sixth Street. The building will be a two-story structure, to cost \$25,000. The new stables of the Brooklyn City Railroad Company on Flushing avenue, near Nostrand, are completed. These stables are the finest in the city, and cost the company \$30,000.

The Brooklyn City Railroad purpose to open a new hotel at Fort Hamilton, on the 4th of July. It was named, on the 21st of May, by President Hazzard, as the Grand View Hotel—an appropriate name, for the reason that from every plaza the view is magnificent, superior, it is claimed, to anything in this part of the country. From the dining room porch can be seen Coney Island, Sandy Hook, the Neversink Highlands, Jersey City, and all those varied objects of interest that make the harbor of New York so attractive. The Brooklyn City Railroad purpose to utilize their large water rights by erecting a dock for the use of yachtsmen. It has purchased the property opposite the hotel which will be made into a park. The hotel and its surroundings will be a great acquisition to Brooklyn, and Fort Hamilton in particular.

The Atlantic Avenue Rapid Transit Commission, on June 3d, decided on articles of association, under which a company is to be organized, according to the purpose of the work. They provide that the capital stock shall be \$1,000,000, in 10,000 shares of \$100 each, the rates of fare to be the same as on the Sixth Avenue lines, New York, including five cents on Sundays. The route is from South Ferry to Kingston avenue, and must be covered within two years of the 1st of November next, and thence to city line within three years.

The Bridge Railroad cannot carry much more than it does now in the busiest hours with the present number of cars to a train. A local paper in speaking of the past and prospective travel, says: "It is reasonable to assume that the aggregate of daily travel can be doubled. That would mean the carrying of at least 140,000 persons, and would make the daily earnings of the Bridge Railroad about \$4,000. With four elevated railroads instead of one brought into connection with the Bridge, the doubling of the present volume of car travel would be a matter of but a few years. When 16,000 persons present themselves at the Brooklyn terminals for transportation between 7 and 8 A. M., it is probable that the utmost carrying capacity of the Bridge cars will have been reached, and with proper rapid transit facilities that number will be forthcoming long before the outer wards of Brooklyn are built up."

Canandaigua.

The Canandaigua Street Railway Company has been incorporated by F. O. Chamberlain and others.

Geddes.

The franchise for an extension of the street railway has been sold at public auction. The bidding began at half of one per cent. and ascended until Charles E. Hubbell bid 100 per cent. of the gross earnings.

Long Island City.

The Steinyway Railway is being extended to Bowery Bay, where a new summer resort is being laid out.

Long Island.

The Long Island Cable Railroad Company has elected the following board of officers: Directors, Anstin Corbin, W. Richardson, J. R. Maxwell, Henry Maxwell, W. B. Kendall, Henry Graves, S. W. Browne, F. A. Schroeder, N. H. Frost and W. J. Richardson; Inspectors, David Gibben and Henry Coles.

Mount Vernon.

A franchise has been granted to the Mount Vernon, New Rochelle and Yonkers Surface Railroad Company. This will be the first railroad to run transversely across Westchester county from Long Island Sound to the Hudson river.

New York.

The Church Street Surface Road was "tied up" for one day by order of the Empire Protective Association. The road is owned by Vice President Hart, of the Third Avenue Company, and the "tie-up" was reported by the strikers as the first of a series of "tie-ups" on the roads and corporations in which he is interested. It is even intimated that a boycott may be placed upon the Pacific Mail Steamship Line, of which Mr. Hart is a large stockholder. Hart is also interested in a Washington surface road, besides holding stock in other corporations.

The Manhattan Railway carried on Monday, April 19, 535,933 passengers without evident or material delay. This traffic was distributed as follows:

| | |
|-----------------|---------|
| Second Ave..... | 83,311 |
| Third Ave..... | 248,599 |
| Sixth Ave..... | 164,436 |
| Ninth Ave..... | 42,587 |

Total.....538,933

The total traffic on preceding Saturday was 365,400 passengers and on Sunday 347,000 passengers. The travel on Monday exceeded that of March 5, when the first general "tie-up" took place, by 132,930 passengers. Up to Monday, the traffic of March 5 (406,002) has been unprecedented. The number of passengers carried on August 8th last (the day of General Grant's funeral) was 400,076, and that was high-water mark until the March "tie-up."

The Third Avenue strike is practically at an end, and the Empire Protective Association has acknowledged its first serious defeat. The tie-up on June 5 was the last expiring gasp, and now the 1,350 men who went on strike over six weeks ago, are left on their own resources, without positions or financial aid. The feeling against the men who have acted as leaders during the strike is extremely bitter, and the strikers declare that if they can get hold of any of the Executive Board the members will meet with hard usage. James P. Graham, the district master workman, has been arrested.

The exploit of the Empire Protective Association—the street-car men's organization in New York city—in ordering a "tie-up" which lasted twenty-four hours, cost the men \$27,300. Over \$1,000 an hour was spent for the privilege of being ridiculous. The New York labor leaders seem the most thoroughly idiotic in the country, and the worst enemies of their kind.

On the 17th of May Judge Parker appointed John O'Brien receiver of the Broadway Railway. Deputy Attorney General Post was dispatched to New York to serve the papers upon John A. Richmond. Secretary Kerr of the Broadway & Seventh Avenue, and Vice President Hendrix of the Twenty-third Street Road, have answered in writing the demands of Receiver O'Brien of the Broadway Surface Road. They claim "that

the contract between their roads and the Broadway Surface Road was not affected by the act of May 4, 1886, annulling the Broadway Surface Road's franchise, and the right of use is insisted upon upon terms and conditions previously stipulated. While the legislation at Albany for annulling the charter was in progress, the directors of the road, aided by lawyers, were busy in laying the foundation for a long contest in the courts, which will delay the sale of the franchise, as provided by the new law, for a long time.

The laying of a cable road in 125th street has been already begun under a contract made by the Third Avenue Railroad Company. The road will connect the two rivers and will be a continuation of the one already in Tenth avenue. The rolling stock has been ordered and six cars have already arrived. The speed will average eight miles an hour. Colonel Paine is superintending the construction.

The engineers and employes of the New York elevated railroads claim to have a long list of grievances which must be redressed under penalty of a general strike.

The strike on the Third Avenue Railroad in New York is at an end, and it ends in a fight between the strikers and their executive committee. There is a discrepancy, it is alleged, of \$30,000 between the amount contributed and the amount paid out in aid of the strikers. The summary of the result of the strike is given briefly by the telegraph: "More than 1,200 men are thrown out of employment; nearly thirty have indictments hanging over them for future settlement, and twenty-two of them are serving terms in the penitentiary for unlawful acts. The cars are running as full as ever, and the boycott is a dead letter." Yet among the men who struck were some who were honest, and who thought they were doing the right thing and the best thing for themselves. The record of good organizations led into folly by vicious blatherskites is getting too long to print.

The General Committee of property owners in Broadway and Madison avenue, who are striving to kill off the Arcade Railway has determined to push things. Edmund Driggs, the chairman, has resigned, because his physician has ordered him to take a rest and a vacation, and William W. Astor has been chosen in his stead. H. H. Rice, representing the Stewart and Hilton interests, has been made secretary; George G. Williams, Treasurer; O. B. Potter, S. V. R. Cruger and Messrs. Mitchell, Cammann and Rice an executive committee, with power to employ counsel and take such measures under the advice of the General Committee as will test the constitutionality of the law extending the Arcade charter.

It is gratifying that the reduction in fares on the Second and Ninth Avenue Elevated lines made a good beginning. There was an increase of 28,000 passengers on these roads on the 1st inst., without any falling off in the travel on Third and Sixth avenues. Of course it will take more than one day or several to demonstrate the success of the experiment; but the result thus far is encouraging.

The Third avenue strikers threaten violence and claim that they have been sold out by the board. It is thought that the car drivers' association will be disrupted in consequence of the dissensions excited by the action of the leaders.

Schenectady.

This city is to have a new street railway. The capital stock is to be \$50,000, and the route five miles long.

* * *
OHIO.

Cincinnati.

The cable road in Cincinnati is being extended to Fountain Square. The Gilbert avenue part, which has been operated for nearly a year, has satisfied the projectors, and they now are at work covering the entire line embraced in their franchise. When they have completed their line to the center of the city, work will be done extending the line to East Walnut Hills, where a large population await the facilities which this road promises.

An effort is being made to procure from the City Council a franchise for a cable road via Race street to Mount Auburn. We are informed

that the company have ample means and are confident of success.

The surface roads in Cincinnati are the victims of the contractors for granite paving, now being laid in all the principal streets. No superintendent can tell when he starts a car by what route it will reach its terminus. The rough but stern dictum, "street blocked," which suddenly starts up in unforeseen localities, necessitates frequent stops, and the conductor is sent ahead to spy out a way by which the obstruction can be flanked.

* * *

PENNSYLVANIA.

Philadelphia.

The Arbitration Board of Street Car Employes' Local Assembly No. 5356, Knights of Labor, received a written reply, on Wednesday, from the Philadelphia Traction Co. The grievances complained of related to the discharge of certain employes. Some of those discharged will be reinstated, and others the company show good and sufficient reasons for discharging.

TO AVOID A STRIKE.—The Philadelphia Traction Company has agreed to reinstate several of its discharged conductors and drivers, and is holding under advisement the cases of others. It is believed that if they are not then reinstated the men will strike.

It is proposed to enforce the rule against stopping cars, except at street crossings. This will save much time.

The Board of District Surveyors has confirmed the plan of the Traction Company for a double line on Twenty-second street, between Norris and Diamond, tracks to be 3 feet 6 inches apart.

A car of the Richmond Branch of the Union line was run into by a P. & R. R. engine lately, the car having slid on the slippery track. One man was injured in jumping from the car, but the car was only pushed off the track, and was not damaged.

The Union Elective Railway Company has, since May 5, operated a car on Ridge avenue. This is the first experiment with wires in an underground conduit, the current being received by a traveler running in the slot. The cost per day of the elective car is estimated at \$1.84, against \$4.74 for a horse car, salaries included in both cases. It is calculated a line ten miles long, with fifty cars, would cost about \$175,000.

Scranton.

The Scranton Suburban Railway Company has been incorporated. Capital, \$20,000.

Pittsburgh.

An application has been made for a charter for the Pittsburgh Elevated Railway Company, with a capital stock of \$50,000.

The Oakland Street Car Co. has resumed with non-union men this morning. Nine cars are now running with a policeman on each car.

A mechanic in this city claims to have invented a compressed air motor for street car travel. The front wheels are unusually large, and there are small air-pumps, three inches stroke by three in diameter, set in the periphery of the wheels. The force of the air-pump is exerted by the weight of the car over the wheels.

* * *

RHODE ISLAND.

Providence.

Providence is agitating for a cable road that will pull the cars up College Hill by the court house, and as the horse railway company who was given the authority in 1873 to lay such a route does not act, others are moving.

* * *

TENNESSEE.

Clarksville.

The street railway is being extended from the depot to Franklin street. The railway was an experiment, and few people believed in its success, but it is stated that it has paid a profit on the investment from the beginning, and stock is now at a premium.

* * *

TEXAS.

Waco.

The Waco Street Railway Company, Waco, Texas, will extend their lines two miles.

WISCONSIN.

Janesville.

Work was commenced to-day for the construction of the Janesville street railway, the company intending to construct and equip five miles of road in five sections, covering the principal parts of the city. Stephen G. Clark, a prominent railway builder and capitalist, of Chicago, owns a controlling interest in the company. It is expected that the first mile of track, from the passenger depot to the Meyer House, passing through Academy and West Milwaukee streets, across Rock river, will be in operation by the 1st of June. The company has a thirty-year franchise.

FOREIGN ITEMS.

TORONTO, ONT.—The street railway strike in Toronto, involving a fight between Mr. Frank Smith, principal owner of the company, and the Knights of Labor, to compel the former to allow his employes to belong to the Knights, has taken an interesting turn. An all-night meeting of all the principal Knights of Labor in Toronto, on May 15, decided to use their influence with the Dominion government, of which Frank Smith is a principal figure, occupying a position in the cabinet, to compel the latter to resign his government position. The influence of the Knights of Labor in Canada is very great, and it is reported that Sir John Macdonald, the Canadian premier, has given Senator Frank Smith the choice of resigning his position in the Dominion cabinet or concede to the Knights of Labor the point for which they were contending. The strikers are running an opposition line of 'busses, which they intend to incorporate. Public sympathy is so much in favor of the strikers that the great bulk of the patronage goes to the opposition line, and the street cars are losing money every day. An attempt to run street cars at night was frustrated by placing dangerous explosives on the tracks, which went off with loud detonations, but fortunately did not injure any one.

NOTES.

FURTHER particulars relative to the Fletcher Car Brake shown in this number, may be obtained from Mr. Geo. Fletcher, 1029 DeKalb Ave., Brooklyn, New York.

THE plan of attaching steam motor machinery to existing car-bodies is from the Baldwin Locomotive Works, to whom we are indebted for the cut and description.

THE HAYCOX DOOR-FASTENER is admirably adapted for elevator doors; orders for quite a number having come in lately to be used for that purpose.

A. K. PORTER & Co., of Pittsburg, are about to ship a dummy locomotive to Yucatan, and one to Venezuela, South America.

GRIPS FOR ST. LOUIS.—The Stewart & Vernon Machine Company is building twenty Nelson & Judge patent grips for the St. Louis cable road. This grip was patented in November, works with a toggle-joint movement, and weighs but 344 pounds—a very light weight in comparison with the patterns in ordinary use. The lower jaw has two small carrying sheaves, over which the cable runs, and the lower jaw is actuated by a hand-lever running to the car above.

CHEAP CABLE CONSTRUCTION.—Ex-Senator Graves and H. W. McNeill, of Dubuque, claim to have a method for constructing cable railroads at a cost not exceeding \$10,000 per mile. The ordinary cost is \$100,000 per mile. Cables are being made at the Iowa Iron Works here, and to test the system, they will construct a mile of cable track in Kansas City or Omaha, at their own expense.

FRANK J. SPRAGUE, of New York has taken out the following patent: (1) Consists of a braking-generator operated by the movement of the car, having its main field-magnet coils supplied from the line and its armature supplying a local circuit, and an adjustable resistance in the local circuit. (2) Consists in placing in the local circuit the operating magnet or magnets of an electro-magnetic brake acting, when energized, upon the wheels of the car. The power of this brake may be regulated by varying the strength of the field-magnet of the machine, or an adjustable resistance may be placed directly in the brake-circuit for this purpose, or both may be used. A very satisfactory run was made last week with this motor on the Thirty-fourth street branch of the Third Avenue Elevated Railway. The Duke of Sutherland was among those present.

MESSRS. HATHAWAY & ROBISON, of Cleveland, Ohio, are rushed with business; they recently filled orders for their transfer tables as follows: Cream City Street Railway, 1; Toronto (Canada) Street Railway, 2; Providence Street Railway, 2; East Cleveland Street Railway, 1; one for the Valparaiso (South America) Street Railway and one for the B. E. & C. — the latter a steam road (where there is a doubling of gauges) the track for the table to run on being 500 feet in length, transfer and track built to handle 100 cars per diem.

THE MANHATTAN RAILWAY COMPANY owns 220 locomotives and between 500 and 600 passenger cars. Their repair shops are extensive and well-equipped with good tools and appliances. Cabs constructed of sheet iron are being built and placed on their locomotives, having been found preferable to wooden ones. The average size of their locomotive cylinders are 10x14 inches and 11x16 inches; drivers 36 and 42 inches diameter; diameter of boilers from 36 to 42 inches. I. W. Peoples, the master mechanic maintains an excellent system, order and neatness throughout the entire works.

We are indebted to Mr. M. Mahony, of 85 Centre St., New York, for the illustration and description of an improved system for heating stations and waiting-rooms which appears in this issue.

THE sales of the Goodenough shoes to the North Chicago City Railway for the past two and a half years have amounted 2,200 kegs of 100 lbs. each. There are 1,750 horses in use by this company, and to shoe them by this system for this period, it has taken 220,000 lbs. of iron.

MESSRS. HUMPHREYS & SAYCE, No. 1 Broadway, New York, make a specialty of furnishing railway or tramway track complete with all motive power and accessories, for use in the handling of heavy merchandise, coal, iron, ores, lumber and logs, brick, etc., also light rails, splice joints and spikes.

THE MESSRS. BURNHAM, PARRY, WILLIAMS & Co., proprietors of the Baldwin Locomotive Works, Philadelphia, have published a neat illustrated pamphlet representing some of the motors they construct for elevated railroads and transportation purposes.

THE NATIONAL MOTOR COMPANY has been incorporated in the city of Chicago, with a capital stock of \$250,000 to manufacture street rail-motors.

THE VAN DEPOLLE ELECTRIC MANUFACTURING COMPANY have contracted and are now engaged upon the construction of an electric railway at Windsor, Ontario. The expectation is that the line will be carrying passengers on the 24th of May. When it is considered that the work was not commenced until the 20 of May, the fact seems to be demonstrated that Electric Railways have passed their experimental stage and taken their place among the substantial, permanent enterprises of the day. The construction of the electric motor cars to be furnished by this company for use on the Minneapolis street railway is being rapidly finished. These cars are well-lighted by electricity, and furnished with electric brakes.

RICHARD P. ERNST,

Attorney at Law,

82 West Third Street,

CINCINNATI, - OHIO.

Commercial Law a Specialty. Also practices in Covington, Ky., and Kentucky State and Federal Courts.

WANTED; FOR SALE; EXCHANGE.

This department has been established as a medium of exchange and bureau of general information, for the convenience of those connected with street railway industries. Street Railway Companies wishing to dispose of or buy cars, appliances or stock, or having contracts to let; persons having vacancies to fill, or wishing situations, etc.; etc., are invited to use this department without charge, being requested only to notify us when the object desired has been accomplished.

THE GREATEST PRACTICAL INVENTION OF THE DAY!

CLIMAX SELF-CLEANING CURRY COMB.

PATENTED NOV. 11TH, 1884.

Admitted by all Horsemen to be just what has been wanted for years.

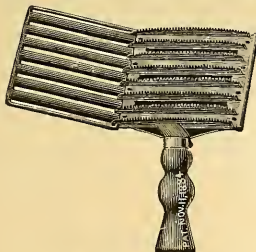

Instead of breaking combs by pounding stalls, etc., the CLIMAX has a strong and durable cleaning attachment composed of curved strips of iron, lying and filling the space between the comb bars, fastened to a surrounding hinged frame, in such a manner that by a light pressure of the thumb it is thrown suddenly open, stripping the comb bars or teeth completely of all combings, such as hair, dust, etc., when by a slight movement it flies back to its original position again ready for operation, all being done easily and speedily, consuming less than a second of time.

Horses carried in half the ordinary time, consequently saving large amounts annually to those who hire. Hear the statements from numerous horsemen all over the country: "The Climax does the work." "Just what we want." "We use it exclusively." etc. Sample comb sent by mail on receipt of forty cents.

CLIMAX CURRY COMB CO.,

210 East Twenty-Second Street,

NEW YORK.

CARS FOR SALE.

8 14 feet double ends, }
 4 12 " " " } Price...\$275 00
 2 10 " " " }

All in first class condition, will be painted and lettered to order.

J. B. H., 43 Lakeside Building, Chicago, Ill.

ADJUSTABLE SHOES.—A correspondent wants to know where the adjustable shoes mentioned in our last issue are made. Will some of our New York or Philadelphia subscribers kindly inform us where those used in these cities are made, and oblige—THE STREET RAILWAY GAZETTE

FOR SALE.—Four second-hand box cars, 12 feet, made by John Stephenson & Co., N. Y.; round closed front platform; rear step and sliding door. Owner will repaint, stripe and letter to order, guarantee brakes; bearings in first class condition, and put in Johnson fare-boxes. All these cars are equipped with Baltimore wheels. Price, \$365, f.o.b. in Indianapolis, Ind. Address BOX CAR, care STREET RAILWAY GAZETTE.

WANTED: POSITION.—By a practical Street Railroad man of 20 years' experience in the management of employes and office details. Also several years experience in handling money and tickets. Strictly temperate and can furnish best of references from past and present Street Railroad Officers and others. Age 43. Address, S. LAMBERT, 177 Bank st., Cincinnati, Ohio.

FOR SALE.—A number of second-hand "bob-tail" cars. Description and price will be furnished on application to "CLEVELAND," care STREET RAILWAY GAZETTE.

WANTED.—A Street Railway, in Nevada, Missouri. A liberal franchise will be given. For particulars, address "Nevada," care of this office.

The Industrial South, Richmond, Va.

JAMES McDONALD, } Editors. JED. HOTCHKISS, M. E., Editor of Mining and Mineralogical Department
BAKER P. LEE, }

THE INDUSTRIAL SOUTH is a first-class weekly paper (24 pages quarto) devoted to the Mining, Manufacturing and General Industrial interests of the South. Every business man, North, South, East and West, who desires to inform himself fully as to Southern resources, industries and developments will find it indispensable. Subscription price only \$2.00 in advance.

Advertisers who desire to increase their business relations in new and rapidly developing sections will find this one of the best and most economical means of reaching the substantial and buyer classes.

Sample copies 6 cents; rates furnished on application. Address

INDUSTRIAL SOUTH, care of B. F. JOHNSON & Co., Business Managers, 1013 Main St., RICHMOND, VA.

HORSE and MAN.

Their Mutual Dependence and Duties.

By the Rev. J. G. Wood, M. A.

Author of "Homes without Hands," etc., with illustrations. 8vo. extra cloth, \$2.50.

"Certainly he has written one of the most valuable books about the horse and his proper care that have ever been issued from the press, for it makes very explicit statements concerning conditions that most books of its class fail to treat with anything approaching fulness, while it antagonizes in the most direct and positive manner common practices of the stableman and blacksmith. Some idea of the scope and method of Mr. Wood's book and of his manner of handling his subject may be gained when we say that eleven of his seventeen chapters are devoted to the feet of the horse, its construction, its proper usage, and so on. Mr. Wood not only finds plenty to say about horses' feet and their treatment, but says it very entertainingly; indeed, the book is a remarkable one for its entertaining qualities. It is not only full of information and important suggestions, but it is most charmingly written."—Philadelphia Evening Telegraph

For sale by all Booksellers, or will be sent by mail, postage prepaid, on receipt of the price by

J. B. LIPPINCOTT CO., Publishers, 715 and 717 Market St., Philadelphia.

Barnum & Richardson Man'g. Co.,
64 South Jefferson Street, CHICAGO.

CHILLED STREET CAR WHEELS

FROM PURE SALISBURY IRON.

Curves, Frogs, Switches, Crossings, Etc.

To Any Pattern.

Light and Heavy CASTINGS for all purposes.

W. H. BARNUM, ALBERT ALLING, WM. E. BEST,
Pres., Lime Rock, Conn. Gen. Mgr. & Treas., Chicago. Sec'y, Chicago.

O. W. MEYSENBURG & CO.,

WESTERN AGENTS

Johnson Steel Street Rail Co.

JOHNSON STEEL GIRDER RAIL
AND STEEL ROLLED CURVES,

Switches and Frogs, also Metallic Ties,

85 Dearborn Street, Adams Express Bldg., CHICAGO.

ST. LOUIS, 204 North 3d Street, Gay Building.

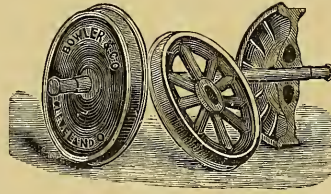

Car Wheels

OF ALL KINDS
FITTED TO AXLES.

Street Railroad Turnouts,
Transfer and Turntables,
Baru Drain Troughs and Fur-
niture.
BOWLER & CO.,
14 Winter St., Cleveland, O.

Anti-Fever Medicine.

A SAFE and
CERTAIN

Remedy for all Diseases
of an inflammatory
character in

Horses & Cattle.

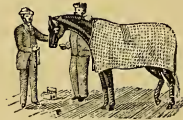

Send for Pamphlet
containing

Testimonials.

Samples FREE upon

application and

Mentioning this Paper

Dr. William Somerville & Sons,

127 ERIE STREET, BUFFALO, N. Y.

Chicago Malleable Iron Co.,

MANUFACTURER OF REFINED

Malleable Iron Castings,

Western Avenue & 26th Street,

CHICAGO.

Street Railway Work to Pattern.

Josephine D. Smith,

350 and 352 PEARL ST., NEW YORK,

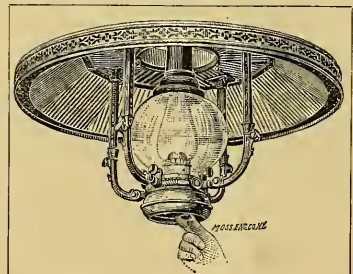

Tin and Brass Box Lamps,
CHIMNEYS, BURNERS, ETC.

METAL CAR TRIMMINGS REFINISHED.
BRASS FINISHING.

Manufacturer of Railroad Car Center Lamps and Reflectors.

The Street Railway Gazette.

VOL. I.

CHICAGO

JULY, 1886.

NEW YORK

No. 7.

Charles T. Yerkes,

who is now so prominently before the public in street and railroad matters, was born in Philadelphia, June 25, 1839. His parents were of Quaker stock.

Mr. Yerkes commenced his business career by entering the banking business in 1859. He was very successful, and at the time of the Chicago fire, in 1871, had accumulated a fortune of over half a million of dollars. The commercial panic of that time caused his financial ruin. He had been the financial agent of the Treasurer of the city of Philadelphia, and in this connection, and on account of circumstances over which he had no control, Mr. Yerkes was temporarily placed under a cloud. However, at the earnest solicitation of prominent bankers and business men of that city, who thoroughly believed in his capacity and integrity, a careful and searching investigation was made, which resulted in his complete exoneration. His estate having been placed in involuntary bankruptcy, he was compelled to start life anew, which he did, with capital borrowed from friends. He soon made his way in the business world, and we find him in the course of a few years with a considerable amount of his fortune regained. It was then that he called his old creditors together, who had stood by him during his days of adversity, and paid them a hundred cents on the dollar, for the money he owed them at the time of his failure, notwithstanding these debts, as it is well known, had been already discharged in bankruptcy.

Mr. Yerkes had always been prominent in horse-railroad circles in Philadelphia, until he came to Chicago, five years ago.

His first venture in this line of enterprise, was in the 17th and 19th streets railway, at the time it was started, in 1860; and it was his energy and ability that brought this road to the efficient condition that it enjoyed in 1871, when it was pronounced one of the best roads in Philadelphia.

He was also one of the organizers of the Continental line of that city. This road was a great success.

Mr. Yerkes now comes before us as the President and General Manager of the North Chicago City Railway Company. The City Council has authorized the introduction of

the cable system by this road. The Mayor has approved the bill. It is stated that contracts have been already made for the requisite machinery. The fact is, that the people of Chicago have long recognized the advisability of this change. The privileges that have been granted to the new road, should include the use of the LaSalle Street tunnel, and certain terminal advantages south of the river.

On account of the peculiar climatic changes that occur in the city of Chicago, the cable has been found to be far superior to the animal power system. Neither snow nor ice can impede it. Neither summer heat nor winter frost, can

affect the regularity of its action. The first scientists of the country have decided in its favor on sanitary and other grounds.

The cities of San Francisco, Chicago, Kansas City, Philadelphia, Cincinnati, Brooklyn, New York, Melbourne, Glasgow and Edinburgh have adopted it. The people of the North Side will soon enjoy this admirable system of intramural transit. It is the intention of Mr. Yerkes to make the plant that will be placed on the North Chicago Street Railway, the best in the country. He will see that all business and financial precaution be taken to achieve this end, and now that the capital has been procured, no expense will be omitted to make this new work as perfect as can be. The appreciation of real estate enters into the considerations that have suggested the cable, and the company expects to develop property on the north side of the river, that has hitherto been unmarketable, and to develop the territory into which the road runs. When we consider the fact that the bridges are open one third of



Chas. T. Yerkes

the time, from eight o'clock in the morning until five o'clock in the afternoon, during a period of nine hours, it is easy to determine what a grand improvement for the North Side will be the use of the tunnel by this company.

The subject of this sketch is endowed with decision of mind and executive force. Practical knowledge and business training, united with natural ability, eminently fit this gentleman to exercise the duties of the position he occupies, and foreshadow for him a brilliant future.

He never does thing "by halves," but as he has remarked, "whatever is worth doing, is worth doing well."

Construction, Equipment and Maintenance of American Street Railways.

BY AUGUSTINE W. WRIGHT.†

(Continued from page 136.)

XI.

PAVING.

The first cost of paving, laid by the street railways of this country, probably exceeds fifteen million of dollars. The maintenance involves a yearly expenditure of millions of dollars!! Not only every stockholder in each company is therefore interested in the quality and kind of paving laid by the street railway companies, but also the far greater number of individuals constituting the general public, who use the pavement in common with the various street cars.

Thomas Young wrote: "There are few departments of practical mechanics in which every individual at some period or other of his life is more interested, than in the management of roads and pavements."

I shall confine myself to a consideration of the best pavement for horse railroad track.

What are the requisites of such a pavement? Clearly a suitable roughness to afford a foothold for the horse, durability, cheapness of original construction and facility with which repairs can be made.

Gen. Gilmore, considering the requirements for paving, wrote, "Roads, Streets and Pavements."

"Another consideration demanding the exercise of sound judgment is that *no pavement combines* the opposite requirements of an even surface for the wheels, and suitably rough one for the horses to travel upon, and a compromise of advantages must therefore *be made in most circumstances.*" (The italics are mine.)

This is not the case with horse railways. Gen. Gilmore wrote of horse paths for street railways. "The best pavement between the rails and upon which the animals appear to travel with greater confidence and less fatigue than any other possessing the requisite firmness and durability, is one of rather small cobble stones, laid with a very slight inclination towards the rails."

The ordinary street rail provides the smooth surface for the wheels and selected cobble stone a foothold for the horses thus combining all that theory would indicate as essential in a perfect pavement. Upon this subject Gillespie in "Roads and Railroads," wrote: "When wheeled carriages are drawn by horses, the wheels should move on the smoothest and hardest surface possible, while the horses require one rough enough to give them a secure foothold, and soft enough to be easy on their feet. These two opposite requirements are united only in roads with trackways, of which two parallel tracks of suitable materials are provided to receive the wheels, while the space between the tracks is filled with a different material on which the horses travel."

James A. Whitney, in a paper read before the New York Society of Practical Engineers, stated: "To provide a pavement which will afford the firmest grip for horse shoes, and at the same time the smoothest running way for wheels, would as nearly as possible, meet the requirements of ordinary vehicles in traffic and transit on the city streets. * * * A good hold for the feet of horses manifestly permits the smoothness of the running way to be utilized to the utmost, either for speed or power applied to propulsion and also avoids the great liability to sudden and serious loss from the slipping and falling of horses upon the pavement."

The New American Cyclopaedia, Vol. 13, page 192, contains the following:

"In other cities, instead of the broad, flat stones, used by the Romans, rounded pebbles called cobble stones, found among the gravel of the diluvium or along sea and river branches, have been very generally used. These when of hard stone, closely set and well rammed down in a bed of gravel and sand form an economical and very durable pavement, which gives secure footing to horses, and is easily repaired."

It seems hardly necessary at this late day to speak of

wooden pavements for horse railway tracks. They are slippery and short lived.

Gen. Gilmore wrote in his aforementioned book:

"Wooden pavements made with blocks of wood, generally yellow or white pine set on the end of the grain, although they have been extensively tried in the United States and elsewhere within the past fifteen years, are unfit for streets subjected to heavy traffic. They are slippery in wet weather and are, of course, very perishable from their inability to resist the wear and tear of traffic or the course of ordinary decay."

Within my own experience, new pine block paving required repairs within six months after it was laid in the horse paths, ruts being worn into the blocks adjacent to the rails. At the expiration of eleven months an inch and a half had been worn off the surface and the entire pavement had to be replaced.

Asphalt is not used in horse paths as the surface is very slippery and dangerous, except in exceptionally dry or wet weather. Square stones 3 or 4 inches wide, 8 to 12 inches long, 6 to 7 inches deep, are used, either of granite, sandstone, trap or other tough and durable rock. The Medina sandstone has given good satisfaction, so far as wear is concerned, in some streets, but will not endure the heavy traffic of a metropolitan line. In my tracks, ruts 1 1/2 inches deep have worn in Medina sandstone next the rails, within twelve months and they had to be replaced by granite. The sandstone affords the horses a better foot hold than the latter, which is slippery at all times, but especially so when dry.

§ Col. Haywood found by observation that granite was most slippery when dry, safest when wet; asphalt was most slippery when damp, safest when dry; wood was most slippery when damp, safest when dry.

I have no hesitation in recommending cobble stones of suitable size and shape, closely set and thoroughly rammed into a bed of good cement gravel, as the best pavement in general for horse paths.

The stones should be hard, preferably of granite or quartzite, water washed, say six inches deep and four inches across the horse path, by three inches wide or kidney shaped, four or five inches at their largest diameter. The stones used by me, average about twelve square inches in the horse path, and a square yard weighed 495 lbs., the average weight of each stone being 4 1/2 lbs.

My practice is to buy the stones by weight 13,000 to 15,000 lbs. making a cord, owing to the quality of the stone. Chicago obtains the best from the Lake Superior beach. Sample sizes and shapes are furnished to pick by. They are brought in sailing vessels and are inspected at the dock. All oversized or undersized stones are rejected or bought at a less price. The balance are weighed. The price varies according to the demand and supply, from \$16 to \$30 per cord on the dock. Before the stones are put in the track, they are again carefully sorted. It was my practice, to lay a granite block adjacent to each rail in the horse path, alternate blocks projecting a couple of inches to afford a bond with the cobble stones. The theory was that more wear occurred next to the rail and that the heavily-loaded teams would force down the cobble and cause a rut. Experience has caused me to doubt the wisdom of this construction, for the following reasons: The granite block had an average bearing surface of twenty-eight square inches. The cobble stone about twelve square inches. The granite did not settle as much as the cobble and made a rough, slippery foot hold for the horses. I believe it would be cheaper to use all cobble, selecting the largest stones to place next to the rail. The saving in horse flesh will more than pay for the repairs.

My tracks have a firm and rigid support, and it is essential that the pavement should have an equally good foundation. I use a gravel that possesses a cementing quality. Before any paving is laid I fill the horse path with this gravel and have the horses travel over it until it is firmly compacted. If cars are not moving I put horses on and find that it is far better packed than is possible by hand ramming. The surface gravel having been loosened after the tramping, the stones are put in place, fitting them as snugly and closely

to each other as possible. They are then rammed twice with a rammer weighing 50 pounds, and left level with the top of the rail, having no crown or inclination across the track, a half inch of gravel is then put on top to protect the stones until they become "set."

A paver averages fifty square yards per diem or five per hour.

When the traffic is of such a heavy character, as in the crowded down town streets of Chicago, the load brought upon each cobble stone when a truck wheel is not upon the rail forces them down and I use granite blocks, having about five times the bearing surface on the foundation; but all my granite has to be sanded after each sweeping, to enable the horses to maintain a foot hold.

The average railroad life of a car horse in this country is estimated at from three to five years.

The character of the paving, on which he travels has much to do with his length of service.

Our car horses fail from having to start a heavy load in a short time. Omnibus horses last much longer.

In a subsequent chapter upon the amount of horse power exerted in propelling a street car, I will give statistics to show that the force exerted to start a horse car is about seven times as great, upon a good track, as the force required to maintain that car in motion at a speed of seven miles per hour. This is the cause of our horses' brief term of service. Upon any pavement other than small cobble stone the horse slips. Upon wooden blocks in unfavorable weather we had to take off his shoes and sharpen the caulks, every third day, resulting in rapid hoof depreciation. If this were not done the horse was injured by falling or straining; from the latter he rarely recovered. We consider his railroad life is prolonged 25 per cent. by the substitution of small cobble stone, and shoeing so that he travels upon his frog. The latter is an elastic cushion provided by nature, to receive the blow and transmit it to his leg without injury to the latter. Years of experience have satisfied me of the truth of this statement, and so shod the horse will travel daily over cobble stone without injury. The increasing labyrinth of pipes in the city streets for sewers, water, gas, electrical conduits, steam heating, etc., etc., cause constant digging up of our pavement. No paving can be more readily relaid, than cobble stones.

The first cost of cobble stone pavement is not great, ranging in Chicago from \$1.60 to \$2.00 per square yard, varying with the price of materials, labor, the distance the materials have to be hauled, etc., etc.

In my experience during five years, on one piece containing 2672 square yards, the annual cost of repairs was 1 1/4 cents per square yard.

I selected this track because it was not dug up for sewers, gas, water, etc.

The repairs to cobble stone pavement should be constant. If one stone works loose, put it back instantly. If this be neglected, depreciation will rapidly ensue, for the stones are bonded each with the other. If one comes out adjoining stones are at once loosened and the pavement is rapidly disintegrated.

Enough has been written to convince any disinterested man that selected cobble stone, properly laid, combines all the essentials of the best pavement for horse railway tracks; durability, cheapness of first cost and repairs, facility with which it can be replaced after the street shall have been dug up; but above all, a firmer foot hold for the horse.

Light vehicles do not seek the tramway to the same extent as heavily loaded teams.

For general street paving, cobble stone possesses no advantages. It is utterly unfit and should not be tolerated, but for the heavily loaded vehicles, cars and wagons, who use the tramway, it offers the greatest advantages.

The following estimate gives the cost of cobble stone pavement in Chicago, the past season, for one mile of horse path, containing 2,444 2/3 square yards.

| | | | |
|--------------------------------|----|-----|----|
| 12 days Foreman at \$4.25..... | \$ | 51 | 00 |
| 45 days Pavers at \$4.00..... | | 102 | 00 |
| 60 days Rammers at \$2.00..... | | 120 | 00 |
| 192 days Labor at \$1.50..... | | 288 | 00 |

| | | |
|--|---------|-----|
| 102 days Teams at \$4.00..... | 408 | 00 |
| 1020 cubic yards of cement gravel, \$1.50..... | 1530 | 00 |
| 807 cords of cobble stone, \$25.50..... | 2057 | 85 |
| Total..... | \$4,656 | 85 |
| Average per square yard..... | \$1.92 | 1/2 |

In this instance the material had to be hauled about three miles, and one team was used to tramp down the earth before the gravel was put in. I have tried flooding the tracks with water, ramming by hand, etc., etc., but get a far firmer foundation from the tramping with horses hoofs.

The smaller the cobble stone the more square yards they will pave per cord.

Particular attention should be paid to the gravel. Sand should not be used in its stead, for it possesses no cementing quality. The gravel should contain just enough iron loam to allow of its packing. Too much or too little are equally ruinous. If there be an excess of loam it will not stand in wet weather. If there be too little, the stones cannot be rammed to a firm bearing; the entire paving vibrates under the blows of the rammer, and the stones work loose.

In the neighborhood of Chicago, I know of only two gravel beds possessing the requisite qualities.

The rammer for cobble stone should be made of some tough, durable wood. I have used maple. Apple would be good. My rammers are turned, nine inches diameter at the bottom, three at the top. They are three feet high, with an upright handle at the top and a horizontal handle eighteen inches from the bottom. The latter is protected by an iron band, and driven full of spikes. A good weight for cobble stone rammers is 50 lbs. or about 1/6 of a pound per square inch of surface.

For square stone paving the face of the rammer is made smaller.

No pine paving was laid in the city of Chicago during the year 1885. Cedar block paving, laid on pine plank two inches thick, over a layer of lake sand one inch thick, cost the city from 97 cents to \$1.24 per square yard, and granite paving upon a concrete bed six inches thick averaged \$4.00 per square yard during the same time.

Mr. A. G. Clarke, vice-president of the Cincinnati Consolidated Ry. sent a circular to various street railroads, asking an expression of opinion as to the best pavement for horse railroad tracks. He received replies from twenty roads, of which he states:

"With regard to the answers I received, I would say in brief that they were twenty in number, seventeen of which advised with very good reasons the use of cobble stones, as follows:

- Boston, Mass., C. A. Richards, Pres. Metropolitan Ry.
- Boston, Mass., James E. Rugg, Supt. Highland Ry.
- Brooklyn, N. Y., Wm. H. Hazard, Pres. Brooklyn City Ry.
- Brooklyn, N. Y., Wm. J. Richardson, Secy. Atlantic Av. Ry.
- Buffalo, N. Y., H. M. Watson, Pres. Buffalo St. Ry.
- Chicago, Ill., Aug. W. Wright, Supt. T. & C. N. Chicago Ry.
- Chicago, Ill., James K. Lake Supt. West Div. Ry.
- Cleveland, Ohio, H. A. Everett, Secy. East Cleveland Ry.
- Columbus, Ohio, A. D. Rogers, Pres. Col. Con. Ry.
- Louisville, Ky., H. H. Littell, Supt. L. City Ry.
- New York City, Wm. White, Pres. D. D., E. B. & B. Ry.
- Philadelphia, Pa., Thos. W. Ackley, Pres. 13 & 15 St. Pass. Ry.
- Pittsburg, Pa., John G. Holmes, Pres. Citizens Ry.
- Providence, R. I., D. F. Longstreet, Vice-Pres. Union Ry.
- Rochester, N. Y., P. Barry, Pres. R. City & B. Ry.
- Springfield, Mass., F. E. King, Supt. S. Street Ry.
- Toledo, Ohio, A. E. Long, Sec. Tol. Consolidated Street Ry.
- Washington, D. C., H. Hart, Pres. Wash. & Georgetown Ry.

I have given you above all the names of those who favor cobble stones. There were four other answers.

- New Orleans, La., J. A. Walker, Pres. N. O. City & Lake Ry. He favors wood, but gives no reason.
- Indianapolis, Ind., P. Woodbridge, Supt. Citizens Ry. Have no granite or asphalt. Gives no opinion.
- Syracuse, N. Y., R. G. Wyndkoop, Pres. G. & W. St. Ry., and Troy, N. Y., Hy. Cleminshaw, Vice-Pres. Troy St. Ry. Both like granite."

The city of New Orleans is so low and wet that it would

be impossible to maintain cobble stone pavement. This is no doubt the foundation for Mr. Walker's preference for wood.

The following letter and answers were kindly furnished me by Mr. Henry Hurt, president of the Washington & Georgetown Railway.

Statements of Leading Street Railroad Companies and Contractors, in Reference to Material for Paving Tracks.

Office of the Washington & Georgetown R. R. Co.,
101 Pennsylvania avenue, Washington, D. C., April 17, 1876.

Dear Sir—What do you regard as the best material to use in paving the tracks of street railroads?

Yours truly, H. HURT, President.

ANSWERS.

Office of Citizens' Passenger Railroad Co., N. W. cor. Tenth and Montgomery Av., Phil., April 18, 1876.

Dear Sir—In our judgment small cobble stones make the best pavements for street railway tracks. Yours, etc.,

GEORGE WILLIAMS, President.

Office of the Second and Third St. Passenger Railway Co.,
2453 Frankford Road, Phil., April 18, 1876.

Dear Sir—There is nothing, in my opinion, that will equal cobble stone of small size laid in a good bed of gravel. We prefer them to any other material. Yours truly, ALEXANDER M. FOX, President.

Hestonville, Mantua & Fairmount Passenger Railroad Co.,
4300 Lancaster Av., Phila., April 19, 1876.

Dear Sir—In answer to your letter of the 17th inst., we would say that cobble stones are considered the most durable for use between the tracks and better for the horse than Belgium blocks.

Very respectfully, A. BOYD, President.

Office 17th and 19th Sts. Passenger Railway Co.,
Nineteenth and Master Sts., Phila., April 18, 1876.

Dear Sir—Yours of the 17th inst. has just been received. We consider the cobble stones, properly paved, the best material for paving the tracks of street railroads. Yours truly,

B. T. HART, Vice President.

Office West Philadelphia Passenger Railway Co.,
N. W. cor. Forty-first and Havelock Sts., Phila., April 18, 1876.

Dear Sir—We have found by experience that small cobble stones are the best for paving between the tracks of street railways where horses travel. Yours truly, B. F. STOKES, Secretary.

Office of the Philadelphia & Gray's Ferry Passenger Railway Co.,
22d St., below Spruce, Phila., April 18, 1876.

Dear Sir—In regard to paving I will say that we prefer cubical blocks on the outside of the rail, but between and on the inside of the rail we prefer cobble stones. Truly yours,

WILLIAM H. SNOWDEN, President.

Office of the Frankford & Southwark (5th and 6th Sts.),
Philadelphia City Passenger Railroad Co.,
Philadelphia, April 18, 1876.

Dear Sir—We find over a good bed of gravel that medium-sized cobble stones are the best footing for horses; we use nothing else. Respectfully yours, R. FRANK ABBETT, Secretary.

Office of Green & Coats Sts. Passenger Railway Co.,
Philadelphia, April 18, 1876.

Dear Sir—I am in receipt of your inquiry of yesterday. I regard small cobble stones the best material for paving the tracks of street railroads. Yours truly, HY. BUDD, President.

Dear Sir—In reply to your inquiry regarding pavements, we consider cobble stones the best for horse paths. Yours truly, E. B. EDWARDS, President.

Office of the Middlesex Railroad Co.,
27 Tremont Row, cor. Pemberton Square,
Boston, April 18, 1876.

Dear Sir—In reply to yours of the 17th inst., we would state the beach stone, known as "Kidney Stone," is the best possible paving for space between tracks of street railroads. Next to this, medium size beach stones. Yours respectfully, GEORGE W. PALMER.

Office of the Second Av. Railroad Co., Second Av.
corner 63d St., New York, April 20, 1876.

Dear Sir—We find small cobble stones the very best material for the purpose named. Yours respectfully, J. SIDNEY GOLDSMITH, Private Secretary.

Sixth Av. Railroad Depot, New York, April 20, 1876.

Dear Sir—I regard cobble stones of about the size of a man's "fist" as the least injurious to horses' feet, and giving them the best foothold of any pavement for the horse track of a city railroad. Very respectfully, T. R. BUTLER, President.

Office of Brooklyn City Railroad Co., No. 10 Fulton St.,
Brooklyn, April 20, 1876.

Dear Sir—Yours of 19th inst. regarding paving, is received. We regard small cobble stones, with very little crown to the paving, as the best material and mode for paving railroad tracks now in use. Respectfully yours, THOMAS SULLIVAN, President.

Office of the Broadway and Seventh Av. Railroad Co.,
corner Fifty-first St. and Seventh Av., New York, April 20, 1876.

Dear Sir—We consider small cobble stones the best pavements for tracks. A horse can get a better foot-hold, and they do not get slippery. The Belgian wear smooth, and in windy and cold weather become very slippery, and we are obliged to put sand on them; they require less repairing but wear out the horses faster; a long and narrow, soft grey granite block is the next best to cobble stones. Wooden blocks are the poorest of all pavements. Respectfully yours,

J. W. FORSHAY, President.

Germantown Passenger Railway Co.,

Office, Eighth and Dauphin streets, Phila., April 20, 1876.

Dear Sir—In reply to your favor of the 17th inst., cobble stones, medium size in proportion to cost, are the best. Granite blocks are too hard, making slippery footway. Yours respectfully,

W. M. SINGERLY, Secretary.

Office of Philadelphia City Passenger Railway Co.
(via Chestnut and Walnut Sts.),
4130 Chestnut St., Phila., April 19, 1876.

Dear Sir—Your favor of the 7th inst. in relation to the best material used for paving the tracks of street railroads, has been received.

In our estimation cobble stones are undoubtedly the best material used for paving between the tracks. The stones to be small and of uniform size, rammed level with the tracks. In starting the car with heavy loads, and on up grades, the horses have a much better foot hold.

We have tried the Nicholson, Asphaltum, Ruble and Belgian block pavements, and consider cobble stones superior to all. The Nicholson will not stand the wear but a short time. The Asphaltum in a little while crumbles up, with the expansion and contraction of our seasons of extreme heat and cold. The Ruble and Belgium blocks wear smooth and glassy, making it very slippery for the horses.

Yours respectfully, W. W. COLKET, Secretary.

The Metropolitan Railway Co., President's Office,
94 Tremont St., Boston, April 20, 1876.

Dear Sir—I prefer for the comfort, safety and ease of the horse, the small size old-fashioned cobble stone. The horses get a better foot hold, especially in rainy weather.

In some of our streets and avenues wood pavements is used, but it is the worst thing possible for our business.

Yours truly, O. A. RICHARDS, President.

Union Railroad Co., Treasurer's Office,
Harvard Square, Cambridge, Mass., April 19, 1876.

Dear Sir—We use the granite block next to the rail, and fill in with Beach cobble stone of the kidney form, and find that it enables the horses to get a better foot-hold than any other paving affords.

Yours, etc., JAMES W. EMERY, President.

Citizens' Railroad Co., Baltimore, April 22, 1876.

Dear Sir—We think cobble stones are much less liable to get smooth and slippery, and much more comfortable to the horse.

Yours truly, JAMES HAGGERTY, President.

Office of the North Beach & Mission Railroad Co.,
San Francisco, Cal.

Dear Sir—We have tried every kind of pavement in our tracks that has been invented, and find the best of all is small cobble stone well put down and covered with gravel. Yours, etc.,

M. S. KELLY, Superintendent.

Office of the Grand St. Railroad Co., New York, April 20, 1876.

Dear Sir—Small cobble stones such as are used in Sixth Avenue railroad in this city.

Office of William Wharton, Jr.,

Street Railway Constructor, Philadelphia, April 20, 1876.

Dear Sir—In reply to your inquiry, I will say that I consider it the best to pave the tracks of horse railroads with small cobble stone about six inches long, and set endwise, with a row of Belgian block set along side of each rail about six inches wide. WM. WHARTON JR.

Office of John Stephenson & Co.,

47 E. 27th St., New York, April 20, 1876.

Dear Sir—Yours of yesterday at hand with regard to material for paving track of railroads. There is nothing better than cobble stone of small size, about four inches in diameter, the shortest way placed endwise. JOHN STEPHENSON.

The foregoing opinions are those of practical, experienced men, from various widely scattered quarters of our vast country, from the Atlantic to the Pacific. They are founded upon personal observation and are worthy of careful consideration. Both theory and practice, which so often differ widely, unite in this instance and indicate that "selected cobble stones" afford the best pavement for horse railroads."

(To be continued)

MR. POWDERLY says: "If every member of the Knights of Labor would only pass a resolution to boycott strong drink, so far as he is concerned, for five years, and would pledge himself to study the labor question from its different standpoints, we would then have an enviable host arrayed on the side of justice."

Some Recent Summer Cars.

Continuing from our May issue our description of Messrs. J. G. Brill & Co.'s new cars, we illustrate a "Palace" open

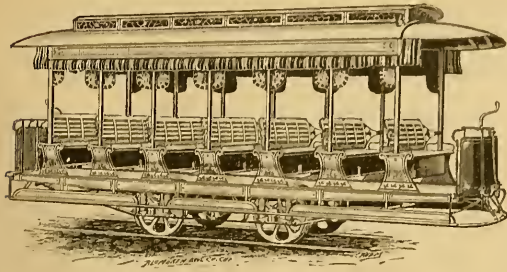

Open Car No. 253.

car, to which was awarded the gold medal at the New Orleans Exposition, in 1885. The length over platform is 23', width at sea 7' 3". It has patented metal panels on the sides at the seat-ends, the seats themselves having full backs, rounded seat-back levers and foot rests. There are driver boxes, "Equalizing Gear," Brill's new brakes, and all of the firm's latest improvements, including horse-guards, etc. The car has the monitor roof, with movable ventilators, glazed with leaded cathedral glass, the destination appearing in the ends. There are two end lamps and one centre lamp, while the ceiling is veneered and handsomely decorated. Curtains are provided on sides and ends, and the handles, seat-back levers and trimmings are bronze. The inside finish is mahogany, in fancy raised panels, moldings, etc. It has a seating capacity for 35 persons.

The other illustration exhibits Open Car No. 177, which

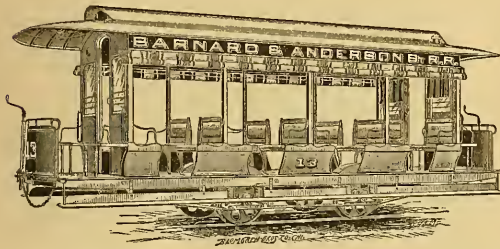

Open Car No. 177.

is an open car, with aisle through the center and sash and doors on the ends. In mild climates it may be used the entire year. In good weather exit and entrance can be made either at the sides, as in ordinary open cars, or from the platforms. Length of car 25'. The seats are arranged vis-a-vis, for 32 persons in the body of the car and four on either platform. It weighs about 4,400 pounds. The trimmings and handles are of bronze, and the car is fitted with all of the firm's latest improvements, as in car 253 above described.

The Electric Railway at Minneapolis, Minnesota.

Minneapolis, with its phenomenal growth, has for the last few years felt the necessity of rapid transit, to bring its people from the city to the suburbs, where cheaper homes and more comfort can be obtained by the multitudes.

The object was accomplished by railway cars, propelled by 75 and 80 horse-power steam dummies doing the work, the latter coming down in the heart of the city with trains packed full. Of late, however, the residents along the streets where the railway passes, and the public in general, have proclaimed the steam dummy a nuisance, and have suc-

ceeded in stopping its coming down in the dense part of the city, so that in order to bring the traveling public in the city some means other than steam or horse flesh had to be resorted to.

After some figuring, the Minneapolis, Lyndale & Minnetonka Railway Company entered into a contract with the Van Depoele Electric Manufacturing Company, of Chicago, to bring the trains in the city by means of their electric motor. The trains consist of three or four passenger cars, each weighing, empty, eleven tons. The number of passengers carried is often as high as 600 at one time, so that the weight of the train is as follows:

| | | |
|-----------------------------|-------|----------------|
| Four cars, each eleven tons | - - | 44 tons |
| 600 passengers, at 130 lbs. | - - | 39 tons |
| Motor car | - - - | 8 tons |
| Total | | 91 tons |

The cars are a fac simile of those used on the New York Elevated Railway. The steam dummy brings the train to a point as far as allowed to come in the city, and then the electric motor brings the train down town with its passengers, and as soon as the cars are emptied, the waiting throng rushes in, and in less than a minute the train is moving toward the dummy, there to deliver its train and receive an incoming train to be brought down.

This operation of the electric motor begins at six precisely in the morning and closes at half past eleven or twelve at night. The distance over which the electric motor travels is at present somewhat near a mile, the speed being about seven miles per hour; this being the regulation speed within the city limits. Considering the constant stopping and starting at each block, the grades in the road and the heavy trains, the electric motor must be given the credit of doing at least as good work as could be expected from any steam engine. During the seventeen or eighteen hours of service, not a single minute of stoppage is made, except to let off and take on passengers. This electric road has been in operation for several weeks, without a hitch or a breakage. The electric motor which is of about 40-horse power, works as perfectly under a heavy as under a light load. The electric generator furnishing current to the motor is driven by a 12x18" cylinder engine, common slide valve, making 125 revolutions per minute; steam 60 or 80 lbs. per square inch; consumption of coal in 18 hours run, 3,000 lbs.

From the permanency and character of work done by this electric railway, it must be admitted that electric railways on elevated, as well as on ordinary roads, will become facts in the immediate future. There is no more trouble to build two or three hundred horse-power generators than to build machines of fifty horse power. Several of these machines can be connected up and run in perfect unison, and by adding their currents together, any amount of power can be transmitted, with at least as much reliability as the steam boiler.

Electric motors and generators are, and can be constructed to-day, which will outlast any steam engine, and from the very nature of these machines it becomes possible to use less expert attendance than in the case of a steam locomotive; the parts being fewer and less liable to get out of order on an electric motor than on any other kind of motor, it must and will become the favorite of the industrial world. The public are gradually losing their skepticism, and what had been proclaimed as an impossibility yesterday becomes a fact to-day.

With regard to economy of electrical transmission, it has been shown by Marcel Depres and others that a mechanical efficiency of over 50% is easily obtained, so that by the use of stationary engines and boilers, where cheap fuel can be used, the production of electric currents and their application leave very little to be desired to make the electric railway system at once practical and economical. The cost of fuel used on a steam locomotive, as compared to a stationary engine, has been discussed too often to be entered upon here, and everybody is well acquainted with the facts.

Cable Railroad Switching.

The North Hudson County Cable Railroad, has perfected arrangements for switching their cars at their upper station, so that the cars are transferred beyond the station, instead of in and before it as at the lower or ferry station.

No switching engines are used on this road, as is the case on the Brooklyn Bridge; gravity and momentum of the car, doing the work of transfer.

At the ferry station, the car comes in on track *b*, which is inclined considerably as shown at *a*, which is an elevation of track and cable.

The car stops at *c*, and is ready to start on its outward trip without further trouble. The cable passes around the pulley *e*, which is placed upon an incline, and serves to

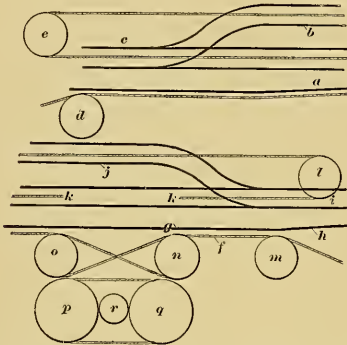

tighten the cable, by being moved outward. Two wheels like *d*, one to each cable, form a guide to the cable while passing from the incline to the plane of the track.

At the inland station, the car comes in at *a*, and stops at *k* to leave passengers. If by mistake of the gripman, the car is stopped between *k* and *k*, there is no method of starting it, except by barring.

At *k*, the cable is picked up and the car runs to *i*. As will be seen by the elevation, the cable drops to the tightening incline, as it passes the pulley *m*, therefore the cable must be let go in season or between *n*, and *m*.

After dropping cable, the car runs to *i* by momentum, and begins to run back as soon as the break is off. The inclined plane *b* is arranged for this purpose.

The car is stopped at *j*, and receives passengers for its return trip. Between *k* and *k* the cable passes to the driving drums *p* and *q*, over the guides *o* and *n*, as described in the AMERICAN MACHINIST of March 20.

The speed of the cable engine has lately been increased from 44 to 48 revolutions per minute, increasing the speed of cable from nearly $9\frac{1}{4}$ per hour, to a little more than $10\frac{1}{4}$ miles per hour.

Since the speed was increased, the motion of cable does not seem as steady, giving the cars a jerky motion, especially when starting up grade.

This trouble is undoubtedly caused by slack in the cable, or by irregular motion of the tightening pulley on the incline at either end of the road.

The tighteners are now held by a section of cable, which is made fast to the tightener carriage, and to an anchorage.

An even vibratory motion given to the tightener, would in the estimation of an engineer, prevent the unsteady motion of the car.

ALL of the "boycotters" who have been on trial in Judge Barrett's court, New York City, for extorting \$1,000 from Theiss, the concert-hall man, in settlement of the "boycott," have been convicted.

A GOOD horseshoer should always be ready to "strike while the iron is hot."

A Plea for a Horse.

Mr. Wood's argument has now conducted us to the conclusion which he thinks is to be drawn from the facts and premises given, i. e., that any horse, under any circumstances, is better unshod than shod; if prejudice demands a shoe, the smaller the shoe the better. We must differ with the first conclusion, while heartily endorsing the latter alternative:—the smaller the shoe, the better the horse.

And first, our reason for rejecting the "bare-foot" conclusion for street railway horses: Mr. Wood has shown that the wild animal, and even animals under light draft,—as in the case of the Manchester physician's horse, cited by him—have been found to do very well without shoes, even on the granite pavements of that city; but in the case of a street-car horse, whose duty consists mainly in continually getting "toe-hold" against hard cobble-stones, so as to enable him to start heavy loads, we do not believe the naked hoof would stand the wear and tear, any more than the human finger-nail would stand continued scratching against a hard substance; for the hoof, like the finger-nail, is produced just so fast and it is not by stimulation of the external surface as in wear or paring away, that its reproduction is accelerated, but by stimulation of the "quick" in the nail, or of the coronary ring in the horse, and all the wear and tear of travel can not effect this. If further argument were needed, believers in "bare-feet" have tried them in Chicago and elsewhere, and have failed.

In order that the subject may be more clearly presented to the reader, we illustrate a section of a horse's hoof, fig. 1, showing the details of structure.

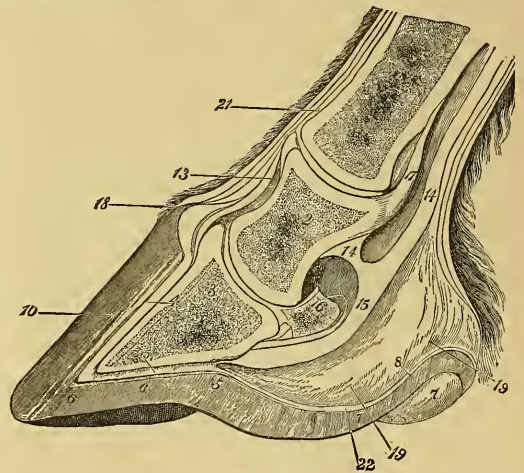

FIG. 1.

This figure is a section of the right half of the fore foot of the horse, divided exactly down the middle. The reader should note carefully the plate to understand the use and relative position of the parts delineated.

1. The large pastern bone.
2. The small pastern bone.
3. The coffin or foot bone.
4. The vascular or sensitive laminae.
4. The vascular or sensitive sole, which is composed almost entirely of blood vessels, the use of which is to form or grow.
- 6 6. The horny sole.
- 7 7. The horny frog.
8. The sensitive or fatty frog, which grows or forms the horny frog. It is the internal foot cushion, upon it rests the foot joint and the large flexor tendon as it passes under the navicular bone in its slanting course to be attached to the foot bone.

The sensitive and horny frogs act as a double cushion at the back part of the foot and limb. They protect, support

and lessen the concussion and strain on the foot joint, back tendons and leg above, at every step the animal takes, slow or fast.

ro. The horny wall—is formed at the top of the hoof, where the skin and hair surround the coronet.

14, 15, 17. Tendons which pass from above to the bones of the foot where they become attached. The curve of the large tendon (15) is plainly shown as it passes under



FIG. 2.

the navicular bone (16). This tendon is a most important agent in the horse's action, as it lifts the foot and limb off the ground after each stride by its pulley-like action.

The free and easy play of this tendon in the foot is maintained by the constant use of the springy elastic cushion at its base and on which it rests, viz: the frog.

Anything which deprives the frog and heels of their natural free motion and use brings on injury to the foot or tendon.

18. The coronary ring, with its pent-house of hair.

16. The only remaining feature demanding mention, is the coffin-bone, which acts like the so-called "sesamoid" bones in man, as a pulley for increasing the leverage of the arge tendon, 15, which acts most conspicuously in utilizing the "toe-hold" above mentioned.

To those acquainted with human anatomy, it will be noticeable that the horse's hoof bears a strong resemblance to the hand of a man, and, in fact, it is but an anatomical variation built upon the same rudimentary elements. It is, virtually, a consolidated hand, flattened at the end, which is covered by the nail. Now to our reason for believing that the lightest practicable shoe is the best: Mr. Wood points out very clearly in one of his chapters, the immense leverage which tells against the horse, from weight applied to the hoof, a fact which after a glance at a horse, needs no demonstration; it has been estimated, however, that the leverage is as one to twelve, so that every pound of shoe is equivalent to twelve pounds on the horse's back, or forty-eight pounds increase in weight for every pound added to each of a set of four shoes. The case would appear to require no further

argument. But further than this, it is essential to healthy feet that the frog should be free to rest on the ground, wherefore, heel calks and long shoes are to be condemned. We think, moreover, that Mr. Wood has clearly demonstrated it to be a fact that no part of the hoof excepting the toe, used in starting a load, needs any protection, and the question of weight then becomes all-important, and the shoe should be made as short as possible, only a good sized toe-piece being desirable.

But beyond the mere mechanical principles involved, another anatomical reason argues against shoeing the rear quarters of the hoof. This is "contraction," a malformation which, we believe, all veterinary experts refer to the effect of the long shoe in preventing proper growth and expansion at the heel.

Figure 2, exhibits a contracted hoof, such as horsemen, unfortunately, will have no difficulty in recognizing.

In contrast with this deformed hoof, we show for comparison a healthy hoof, and by comparing the two, even the most inexperienced will have no difficulty in comprehending the pernicious effects of full-shoeing—in this case at least.

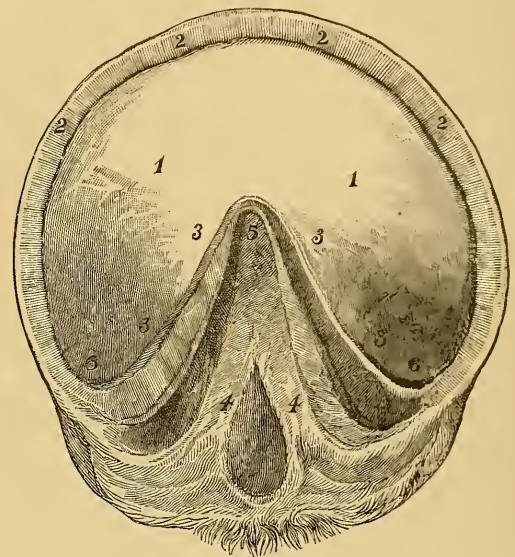

FIG. 3.

1 1. *Sole of the Foot*—Formed or grown from the sensitive sole. Varies from 1/2 to 1 1/2 inches in thickness, supports the Foot or Coffin Bone.

2 2 2 2. *The ground surface or bottom of the wall*—on which rests the shoe when nailed to the foot. The wall is thickest at the toe, and outside quarter becoming thinner towards the heels.

3 3 3 3. *The Bars*—are a continuation or bending inwards of the wall, extending forward and meeting near the point of the frog. They are braces assisting in keeping the foot apart and broad at the back part.

4 4. The body of the horny frog, (the foot cushion or buffer).

5. The point of the frog.

6 6. The union of the sole with the wall and bars.

The remedy for all this is, we may say, in recapitulation, —a light shoe, a short shoe, a shallow shoe, and a shoe without calks. We have already stated our opinion as to the preference among the various patterns of shoes in use, and here leave the subject, hoping that we shall have in some small measure, aided the cause of common sense, by calling attention to Mr. Wood's valuable book, and showing how, in one way "a merciful man" may be "merciful to his beast."

Cable Railway Propulsion.

BY W. W. HANSCOM, M.E., M. TECH. SOC.

[Copyright by the Author.]

I must premise my remarks by the statement that the subject is so comparatively new in its practical results, and so little has been done in the development of the system outside of San Francisco and Chicago, that we have but little of the experience of others which has been published upon which to rely for the collection of data. The subject matter of this paper will be mainly a collection of such facts and experiences as have come almost directly under my own observation, and such conclusions as I have arrived at are from the grouping together and endeavoring to find from these facts what constitutes some of the more important conditions connected with the construction and operation of cable railways.

The record which I have of the great number of persons who have directed their attention to this mode of propulsion of cars at once shows that the subject is not new, and that it has only waited until the particular time and conditions should arrive when it would be practically developed. This time arrived, and the conditions were propitious, when the Clay Street Hill Cable Road was built, and from the time at which this experiment passed into the domain of practical and commercial success an increased interest has been manifested in the pecuniary results to be attained, in comparison with the hauling of street cars by horses, and I need not enumerate the list of inventors whose patents have a bearing on this subject, and number several hundred, but pass directly to the features of the cable roads constructed and operated in our city.

In the construction of the Clay Street Hill Road, it was necessary to observe the strictest economy, as it was an experiment, or at least so considered by those interested, and consequently it was left to further experience to determine, in case of success, what should be the character and kind of material and workmanship to be adopted in the construction of additional cable roads.

In observing the condition of the street along which this road was to be constructed, it was found that it consisted almost entirely of grades, except at the crossings, which were level. These grades being in some places as steep as 1 in 6 $\frac{3}{4}$, and the steep grades made a sharp angle when leaving the level crossings, with curves of very small radius connecting the various changes from grade to level and from level to grade. The street was straight, so that there was only vertical and no lateral deflection. This was the serious matter, as in leaving a level crossing for a steep upward grade, the strain on the cable would bring it upward and through the slot of the tube made for the connecting bar between the car and the rope.

Consequently it would require a sheave above the cable to keep it down at these points, so that while sheaves were used to support the cable when the weight and strain were downward, they were also required at certain points to counteract the upward strain, and whatever arrangement or apparatus might be used to connect the cable with the car, that part which clasped the cable must pass above the sheaves placed under the cable to support it and must also pass under the sheaves which were placed above the cable at points which were required to be kept down. These sheaves, therefore, must be at such distance apart, vertically, in reference to each other and the track (over which the wheels of the car which carried the gripping apparatus were to run) that when the car would be immediately over one of the sheaves which was under the

cable, that the bottom parts which clasped the cable would be some little distance above the sheave, so that a slight variation of the car or gripping apparatus in height would not bring the grip and sheave in contact. Also when the car is directly over a sheave which is above the cable to keep it down, the top of the part which clasps the cable must be a sufficient distance below the sheave that it will not touch in passing. In order that these requirements may be met, the vertical part of the gripping apparatus which passes upward through the slot of the tube and connects with the car, must be so located that it will pass to one side of the sheave above the cable, and this is arranged by projecting the part which clasps the cable sideways from the vertical part, which is shown by the drawing.

It will be seen that when the cable is held in the clasp (or, as they are called, the jaws of the grip) it is lifted

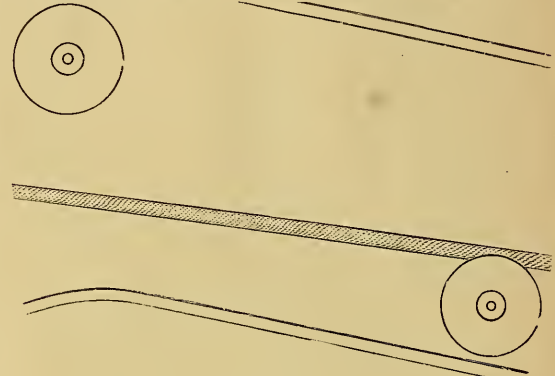

FIG. 2.

above its normal position in the groove of the lower sheaves, and also that it is carried down away from the sheave, which is used to keep the cable down where sharp angles occur at upward change of grade.

This drawing shows the upward tendency of the cable in crossing a street and going up a grade; it being lifted from the lower or carrying sheave and brought up against the under side of the top or depression sheave.

This accedes to the conditions so far as a line is concerned, when there are no horizontal deflections occurring, and there are none on the Clay Street Hill Road.

The form and size of the gripping arrangement being determined upon, such space between the lower and upper sheaves must be allowed that the grip will easily clear each, and some additional clearance space for variations which may occur in the height of the grip by the wear of the wheels, or variations in the level of the track in reference to the tube, added. Then the diameter of the sheaves being fixed, this fixes the depth of the tube, and the width will be fixed by the width of the grip and sheaves and necessary clearance.

In constructing the Clay Street road, wood was used to a large extent. Cast-iron frames were made to conform to the desired cross-section of the tube, and placed about three feet apart, they having ribs cast on them so that planks two inches thick could be laid from one to another, and held in position by the ribs, thus forming a tube of wood with supporting ribs of cast iron.

Ties extend laterally from these cast-iron ribs, upon the outer ends of which are placed stringers which carry the rail. The castings, as shown, are open at the top, so that the vertical part of the grip may pass through, and close on each side of this opening; extending from one casting to another, are short car-lines, which are bolted at each end to the casting, thus keeping them at the proper distance apart and maintaining them in proper position. On top of these, and extending over several of the castings, are laid wood scantlings, which form the slot, and to protect the top from wear are placed iron straps fastened to the scantlings by

wood screws. The surface of the roadway between the slots and the rails on each side is formed of wood plank, as shown. This forms the general construction of the tube from one end of the road to the other, except at the point where the cable is made to enter the engine house to be connected with the driving machinery.

Along the straight portions of the tube the lower sheaves are about nine inches in diameter; those above the cable being about seven inches, as it was considered necessary to keep the distance between the surface of the street and the upper, enlarged part of the tube as small as consistent with strength to support the traffic of vehicles on the street, and also that the distance between the cable and the part of the car from which projects downward the vertical bar or shank (which has the grip on its lower end) shall be the minimum.

At the ends of the road are placed large sheaves, around which the cable passes to return, there being four tracks and two tubes, and the diameter of these large sheaves, which are placed with the axes vertical, is equal to the distance between the centers of the two tubes or sets of tracks, which is about eight feet. Experience in the use of wire cables had shown that where the cable makes any great change of direction, as a right angle or more, and even much less, the diameter of a sheave over which the cable passes should be about 100 times the diameter of the cable. In this road the cable was a little less than one inch in diameter, and the sheave about ninety-six inches. In order that the cars might be transferred from one track to the other at the end of the route, two turn-tables are arranged, the diameter of each being a little less than the distance between the centers of the two sets of tracks, each turn-table having two rails across it, equidistant from the center. These two tables are geared together, so that by turning one through an angle of ninety

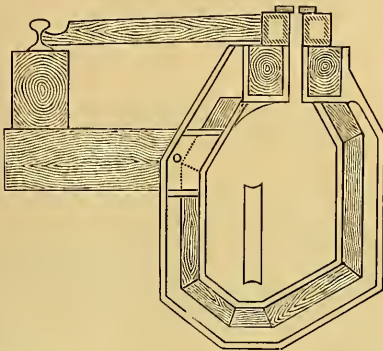

FIG. 3.

degrees the two sets of tracks will be brought in line with each other, and a car which had previously been brought from one of the lines of rails on to the table, can be pushed on to the other table, and then, by reversing the movement of the tables, the tracks are brought in line with the main line, and the car can then be moved on the opposite track, and on its return journey.

In transferring ordinary cars from one track to another, the tables would be simple plates placed on central pivots, and supporting rolls around the circumference; but the car which carries the gripping apparatus and is called the dummy, having the shank of the grip projecting downward and through the slot into the tube, would in this case have to be raised out of the tube to allow the dummy to go on the turn-table. This operation would not only require time, but the expenditure of considerable labor. That these might be avoided, the table was constructed of two parts, an upper and lower plate, connected together by ribs or ties. The top plate has a slot across its diameter, and the space between the upper and bottom plate will allow the lower portion of the grip to pass through—the ties between the two plates being far enough apart for the grip to pass through without touching. Now, as shown before, by revolving the

tables one-quarter way round, the slots, through the upper surface of the plates, are brought in line with each other, and the dummy can, with its grip, be pushed from one table to the other, and so on to the other line of rails.

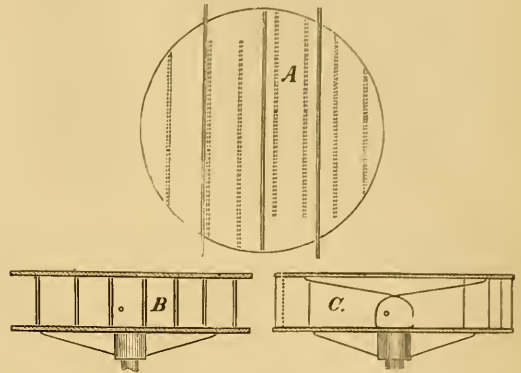

FIG. 4.

There is still one other requirement, and that is that the cable shall also pass through the table, so that the dummy may be drawn on to the table and then dropped, and in order that this may be effected, the cable is carried through the table and some convenient distance beyond, before passing around the large sheave. Now the connection between the upper and lower plates of the turn-table must be so located that the table may be revolved through one-quarter of a circle without bringing this connection in contact with the cable, which is continually moving through.

A is a plan of the turn-table.

B is a vertical section at a right angle to the slot which divides the top plate.

C is a vertical section in line with the slot through the top, and shows the manner in which the ties between the two plates are arranged so as to allow the cable to pass freely through when the table is turned so as to allow the car or dummy to pass from one table to the other.

As the large sheave at the end of the route lies in a horizontal position, or nearly so, a large pit or chamber is required and the covering of this must be of sufficient strength to sustain any traffic which may pass over it, as it may be in the middle of the street; therefore, the thickness of this cover, and the fact that the axis or shaft of the sheave is vertical, it requires journal-bearings, both top and bottom, and this, added to the thickness of the cover, will carry the groove of the sheave some distance below the line of the cable in the tube, so that the cable at the point of leaving the tube to enter the chamber containing the large sheave will be deflected downward over a sheave somewhat larger than those supporting the cable in the tube, say thirty inches in diameter.

This large sheave is carried on a frame having wheels which run on a track prepared for it and of such a length that it may have a movement of ten feet or more. A chain attached to the end of this frame or carriage passes over a sheave at the rear end of the chamber and has a weight attached which maintains a tension on the cable passing around the large sheave, and will take up any stretch that may occur in the cable, and yet, in case of excessive strain, will yield and prevent rupture of the cable. A similar arrangement is at each end of the road.

At the point where the cable enters the engine-house the cable is deflected vertically over two sheaves eight feet in diameter, and thence at right angles to a horizontal direction, when they enter the engine-room, passing over a driving drum; thence over an idle sheave; thence over the driving drum again and backward to a sheave under the street, under which it passes and upward over a second sheave to the direction of and into the tube, when it con-

tinues on its route. These sheaves and driving drum are all eight feet in diameter. The driving drum is geared to the engine so that the cable has a speed of 528 feet per minute, or six miles per hour. There are 11,000 feet of cable employed in one piece, and it makes a total revolution over its route in about twenty-one minutes.

In changing the cars at the ends of the road the dummy is disconnected from the car and first transferred, then the car follows and is connected again to the dummy, and the train is ready to start so soon as the cable has been taken

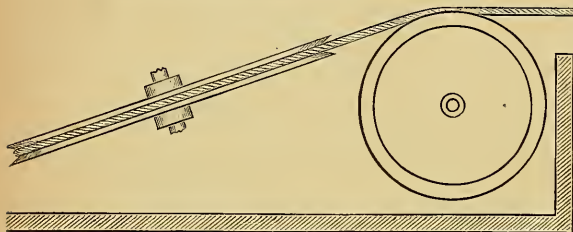

Fig. 5.

into the grip. This grip is so constructed that the cable is admitted between the jaws from the bottom side, and, as by opening the jaws the cable falls out, dropping away from the grip down into the carrying sheaves under the cable, it becomes necessary, in order to get the cable within the jaws again, either to raise the cable or to lower the jaws until they shall have brought the cable within them, and then raise the grip, bringing up the cable to such a height that the bottom of the grip will sufficiently clear the sheaves. This grip is so constructed, that by a hollow screw at the top passing through a nut, which is supported by a frame and encircled by a hand wheel, the turning of the nut will lower the hollow screw, and with it the gripping jaws, until they are low enough to take the cable, when the jaws are partially closed, so that while they will prevent the cable from dropping down it will still freely pass through and not draw the train until sufficient pressure is put upon it, which is done by means of a screw drawing a wedge between a frame and a bar, thus forcing the jaws against the cable with any desired force, the power by this arrangement being as 480 to 1; in other words, one pound applied to the screw by the man operating the grip gives a pressure of 480 pounds on the cable, less the friction of the moving parts.

(To be Continued.)

One-Third the Cost of Steam.

For years past inventors and engineers have been deeply interested in the demonstrations of the Triple Thermic Motor Company, of New York City, a corporation of business men who have been successfully showing, says a correspondent, that their mechanicians have solved the old problem of turning a low-temperature chemical into a powerful vapor, and by steadily continuing this operation, producing almost a fourfold power from a given quantity of coal or steam. Their engines have been privately running for months in New York, Newark, N. J., and in Lowell, Mass. Many of the most eminent engineers and professors have, with many others, examined the motor to their satisfaction, and declare the new force to be a veritable miracle. Large and constant power produced with ease and certainty, and by simple appliances, at about one third the cost of steam, is what is claimed, and the enthusiastic managers are delighted with their success.—*Ex.*

ALTHOUGH advertising on the sides of open horse-cars in New York may be a source of some income to the company permitting it, the disfigurement is not pleasing to the public eye.

Wrought Iron Center Steel-Tired Wheels for Steam and Street Railroad Purposes.

Since the early days of railroading, wheels for locomotives and cars have received much attention from engineers and founders. The forms have been numerous. They have been made of cast iron, of cast iron and wrought iron combined; they have been forged; lastly, they have been partly stamped and partly forged, always with special welds for spokes and rims.

The locomotive driving wheels on our steam railroads, including the elevated roads, have, with few exceptions, if any, cast iron hubs and spokes and rim, upon which a steel tire is shrunk and bolted. Truck wheels for tenders and passenger and freight cars are of the cast iron plate type with chilled face. A few of the street railroad companies use an open wheel, with wrought iron spokes radiating from the central hub. The latter are certainly in appearance, if nothing else, more pleasing to the eye. They are light and strong, and answer the purpose, but the manufacture is more costly and uncertain than that of the ordinary cast iron plated wheel.

The accompanying engraving shows a new departure in the construction of locomotive driving and passenger car wheels, adapted either to the regular steam or elevated rail-

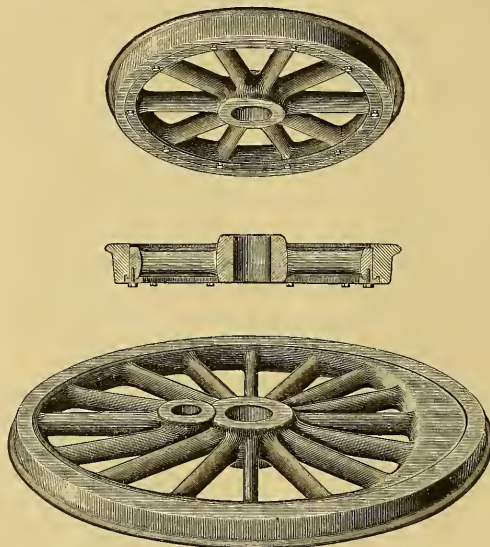

roads, and shortly to be introduced on street railway cars. The wheels are known as the Arbel wheels and hitherto have been principally in use in Germany, Austria, Belgium, Italy and Switzerland. They are used almost exclusively on the French railways.

In reference to the engraving, it will be seen that the hub spokes and rim are of wrought iron. They are made at a single operation, being welded and stamped by a few blows from a heavy steam hammer, thus forming one solid homogeneous forging of hub, spokes and rim. The life of the center is practically unlimited. They are now made of various diameters, ranging from discs 6" diameter to 86" diameter. The weight of center of a 24" wheel is 168 lbs.; total weight with tire complete, 405 lbs.; of a 42" wheel complete, 750 lbs. For street railway purposes, the hub and spokes and rim can be stamped, so to speak, at one forging, and elasticity and spring obtained by introducing wood between the rim and the tire. Between 1871 and 1883 there were manufactured 72,751,524 lbs. of what are termed by the constructors "Arbel centers." For these wheels are claimed strength, lightness, safety, durability and economy.

Baltimore and Hampton Electric Rail-way.

Eight months report of this company shows great economy, having carried 188,591 passengers in the last eight months at a cost of about one-half that of running with mule power the same eight months in the year previous. The average speed being twice that obtained formerly.

This road has so many curves that even the very best device of cables would be under great disadvantages on this account, and the cost of original construction and running expenses of cables would be enormously greater than for the electrical system which is now used. The conductors (iron

conductors can be made for city use, either overhead or underground the first being much cheaper. The underground conductor can be furnished at much less cost than for cables. On a suburban road the conductor can be laid immediately on the ground, the expense not exceeding the cost of a small rail and the laying.

Power for all kinds of use can be furnished from the same station which supplies the power for the railway and can be readily rented out at a net profit of from 30% to over 80% per annum according to the amount used, and where water power can be obtained a still greater percentage can be earned.

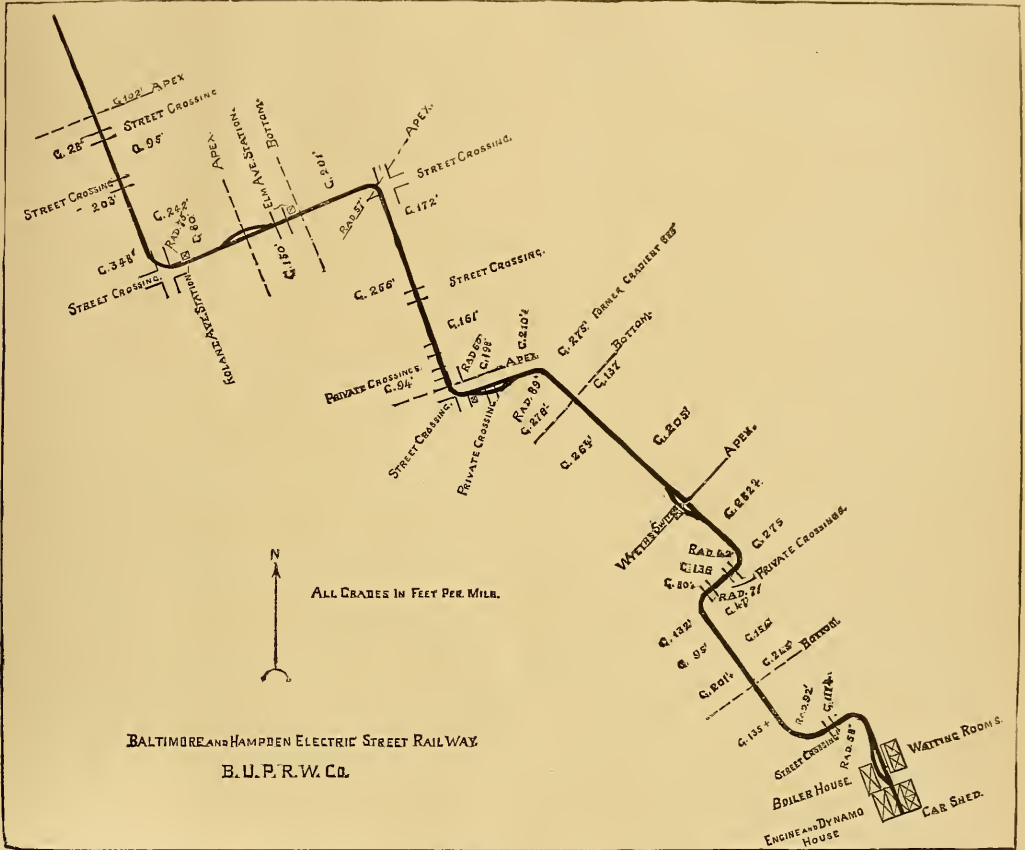

rails in this instance) are laid on the ground with only slight insulation, and the tension of the current is so low that there is no possible danger from contact with it.

The following table gives the exact comparison for the eight months above alluded to:

Eight months comparison between mule power and electricity.

| | From Sept. 1st, 1884, to May 1st, 1885, by mule power. | Sept. 1st, 1885, to May 1st, 1886, by Electricity. |
|------------------------------------|--|--|
| Passengers carried..... | 156,599 | 188,599 |
| Cost of Motive Power..... | \$4,714.00 | \$3,141.00 |
| “ “ “ per passenger..... | .0301 cents | .0166 cents |
| Cost of Motive Power per mile..... | .01505 cents | .0083 cents |

Saving in cost of propulsion 33%. Increase in traffic 20%.

We have also obtained an exact diagram showing the curves and grades of this Railway, which we annex.

A Princess who Likes Horse-Cars.

London *News*: The late Spanish King's sisters were with the Queen during her trial, and they showed great kindness and affection to her. They both wore colored dresses in honor of the occasion; the Infanta Isabel was in white and green striped silk, and the Infanta Eulalia looked very pretty as she walked home on her husband's arm during the afternoon, in a light brown spring toilet. This Infanta, since she married Prince Antonio of Montpensier, no longer lives in the Palace. They have hired a small house with a garden in the Castellana, and as they are both very young they enjoy housekeeping very much. The Infanta's greatest delight is to go into town on a horse-car.

SAYS an experienced blacksmith: "More horses' feet are ruined by rasping the hoof than by any other cause." This outside coating is impervious to water and does not evaporate. When broken into by rasping, the moisture of the foot evaporates, leaving the hoofs dry and brittle.

THE STREET RAILWAY GAZETTE

JULY, 1886.—MONTHLY, \$2.00 PER YEAR.

COPYRIGHTED JULY, 1886.

THE WRIGHT-MONROE CO., PUBLISHERS.

GENERAL OFFICES:

CHICAGO, CHICAGO, NEW YORK.

43 LAKESIDE BUILDING. P. G. Monroe, General Manager. E. V. Cavell, Business Manager.

181 BROADWAY, CITY. H. D. Cozens, Business Manager. T. P. Pemberton, Associate Editor.

Augustine W. Wright, Henry C Lockwood, George B. Heckel, Editors.

BRANCH OFFICES.

PHILADELPHIA, Pa., 24 N. 4th St., J. Waterkeyn, Mng'r. ATLANTA, Ga., Chamber of Commerce Bldg., Wm. Minnigerode, Mng'r. ST. PAUL, Minn., 558 Drake Block, V. R. Benham, Jr., Manager. SAN FRANCISCO, Cal., 1322 Fine St., G. W. Fairchild, Manager.

A CABLE road does not eat anything when it is tied up.

PROPERTY-OWNERS ought to know something about what is for their own good.

"EVERY improvement of the means of locomotion," says Lord Macaulay, "benefits mankind, morally and intellectually, as well as materially."

THERE has been an evolution in the machinery of locomotion from the first pair of wheels to the last invented railway appliance; from the palanquin to the palace car.

HORSE and cable cars will always have all they can do, and in the development of our great cities will be tested to their fullest extent. Systems guaranteeing more rapid transit will only increase the travel on these roads. There will always be passengers who ride short distances.

WHILE the last tie-up in New York, that threw out of employment temporarily 15,000 men, shows that street railroad employes have reached a high degree of development in organization, it also demonstrates that their leaders are ignorant and unscientific men. Public opinion pronounces this judgment.

A COTEMPORARY states that "there is a little room for doubt that there is a growing opinion in the United States in favor of city ownership of street railways." In our opinion nothing would corrupt and destroy a democratic government sooner than to turn over the ownership and management of its railways to the State.

CAN it be possible that the obstructionists' policy is honest? Sometimes we feel, particularly when we read of men whose chief business seems to be to clog the wheels of progress and improvement, that the saying is true "that every man has his hand upon the throat of his neighbor."

DID it ever occur to the employes of the horse railways, who have repeatedly interrupted the traffic of whole cities upon a mere fancy or freak, that their action was tyrannical and aggressive? Did it ever occur to these men that there are systems which require comparatively few employes? Have they ever heard of the elevated and cable systems, or the various kinds of motors that are being introduced?

MINISTER WINSTON soon discovered that his position at the court of the Shah was a "hollow mockery." He immediately sought a way to give a practical turn to his mission. He determined to develop all the riches of the Orient by building a railroad from Teheran to the Persian gulf. He was getting on marvelously well until an obstruction was put in his way; not by a board of aldermen, but by the Vizier, who demanded \$30,000 for the concession. Mr. Winston should remember that he had only one demand made on him, while Mr Sharp was compelled to satisfy a legion.

How the commercial, financial and residential portions of a city may be disconnected from each other in such a manner that each may have a section devoted to its special interests and purposes, is a question that affects the physical and moral growth of these communities. As the city grows, the office, workshop and home must necessarily be separated from each other by long distances. The great mass of the people who transact business in cities, or who are employed as clerks or workmen, ought to reside within the city limits. In fact outlying towns are too difficult of access, and the fare on suburban roads is usually too high.

COLONEL CARROLL D. WRIGHT, Commissioner of Labor, has chosen as the subjects of this year's investigation by his Bureau: Strikes in the United States; the condition of railroad employes; work in penal institutions; the cost of production and distribution of products; and the employment of women workers in great cities.

AFTER all that has been said and written about solving the labor problem, perhaps the very best way will be for each man to roll up his sleeves and solve it individually for himself in his own way.

THE bell that is placed in the center of the roof of open street cars, which the conductors frantically sound to warn vehicles off the track, like the back-to-back seat, ought to be abolished.

Cable Railways.

The following are some extracts from the concluding argument of Charles P. Shaw, Esq., in support of cable railways, before the Commissioners of the Supreme Court of the State of New York.

"That proposition" (for rapid transit) "is not only true respecting means of communication between city and city, state and state, and across continents from sea to sea, but it is also more intensely true as to furnishing means of communication within the metropolis where the ganglia of human life and thought and enterprise are clustered."

"And thus it is that Mr. Holmes, the president of the Chicago Cable Road in his affidavit says: since this improvement in means of locomotion has been adopted in Chicago, we find that our car conductors have become superior men, mentally and morally." * * * "Compare a car conductor on the elevated railroads of the city of New York with a car conductor on a horse railroad. Behold how one is clothed, as it were, with a sort of official dignity and importance." * * *

"I just spoke of this cable railway grip. Without, it all that I for five long months have contended for before you would be a vain folly. With it, we are made to conceive how the grasp of the iron but flexible fingers of a metallic hand can work the chords of the harp of human progress in this matter of intramural transit, as perfectly as Orpheus could have done it." * * *

"The advent of this grip, as a practical realization, seems to have been a providential marvel to our city, appearing at the time and under the circumstances that it did. Its efficiency and perfection had received the test of ten years' practical operation in the city of San Francisco, five years in Melbourne, Australia, and three years in Chicago. Cities illustrating all the topographical peculiarities of our metropolis, and also all variations in the business and activity of its thoroughfares."

Mr. Shaw, in the course of his remarks read from a communication addressed to the Mayor of the City of New York, and signed by a large number of residents, house-holders and tax-payers. The advantages claimed for a cable system may be summarized as follows:

1. The steepest grades are as easily worked as levels.
2. The cars may be stopped instantly or slowed gently at any point on the line, and started with promptness, ease and gentleness.
3. The speed can be established at any rate desired and varied on any portion of the road to accommodate it to obstructions in the way.
4. The method of working is noiseless and even, and unaccompanied by any annoyance whatever.
5. Perfect cleanliness of track is secured, an important sanitary element in the system.
6. An unlimited capacity of increase at any time an increase may be required.
7. Perfect freedom from snow blockade, as the power is sufficient at all times to remove the snow as fast as it falls.

Brave Words.

Nothing is more demoralizing to a community than a suspension of, or an interference with, the operation and administration of the law. As soon as a condition of things exists that prevents the enforcement of private contracts, the whole body politic is shaken and distributed. An incipient revolution is already started when the courts fail to act. This is particularly true in the United States where the judicial branch of the Government is held in such high respect. Judge Deady of the United States District Court, for the District of Oregon, has come to the front and given utterance to some plain truths, which, although they refer to the Chinese question, are applicable to the disturbed condition that has been developed in many parts of the country by the aggressiveness of a few leaders who are, themselves, ignorant of the great forces that are transforming and revolutionizing modern industries. These misguided men are striking at symptoms and not at diseases. They have already brought down upon themselves the displeasures of the people by the course they have taken, which is both maladroit and unscientific.

"An evil spirit is abroad in this land," said Judge Deady, "—not only here but everywhere. It tramples down the law of the country and fosters riot and anarchy. Now it is riding on the back of labor, and the foolish Issachar crouches down to the burden and becomes its servant. Lawless and irresponsible association of persons are forming all over the country, claiming the right to impose their opinions upon others, and to dictate for whom they shall work, and whom they shall hire; from whom they shall buy, and to whom they shall sell, and for what price or compensation. In these associations the most audacious and unscrupulous naturally come to the front, and for the time being control their conduct. Freedom, law and order are so far subverted, and a tyranny is set up in our midst most gross and galling. Nothing like it has afflicted the world since the Middle Ages, when the lawless barons and their brutal followers desolated Europe with their private wars and predatory raids, until the husbandman was driven from his ravaged field, and the artisan from his pillaged shop, and the fair land became a waste.

The dominant motive of the movement is some form of selfishness, and its tendency is backward to barbarism—the rule of the strongest, guided by no other or better precept than this: Might makes right. This is not the time or place to inquire into the cause of this condition of society. It may be the natural outcome of the modern political economy, which, assuming the conflict of private interests will produce economic order and right, has reduced the relation between capital and labor to the mere matter of supply and demand, and limited the duty of obligation of the one to the other to the payment of the minimum of wages for the maximum of labor on the one hand, and the getting the maximum of wages for the minimum of labor on the other.

But, whatever the cause, I have faith that the teaching of experience, and the good sense and love of justice of the people, will find a remedy for the evil in time. And in the meanwhile it behooves those of us into whose hands the administration of the law and the conservation of the public peace is confided to do what we can, wisely but firmly, to prevent this evil spirit from destroying the material resources of the country, and making any improvement in the condition of society, in this respect, still more difficult and doubtful.

The Elevator and the Elevated.

The finest commercial buildings in the world are being constructed in the large American cities. These structures are nearly perfect in their appointments. Every kind of modern appliance is found within them. The custody and care of these business palaces are committed to superintendents, who employ a small army of workmen and skilled artisans. The day of the janitor is passed; the reign of the superintendent has commenced. It is not a very unusual thing to pay him a salary ranging from \$2,000 to \$3,500 a year. Properly to fill these positions it is necessary to exercise considerable executive ability. The most salient feature of these buildings is the introduction of the elevator, which utilizes their highest stories. Some ten years ago, it was quite an unusual thing for offices to be in use above the third story. The pleasantest offices are now found on the 5th, 6th, 7th or 8th stories. The result of this building in the air is immeasurably to increase the possible area for offices and to consolidate large masses of people, during the business hours of the day, within certain portions of our cities. The crowded condition of the streets, the packing of our vehicles of transit, attest the truth of this statement. In a word, the elevator has been the means of huddling together a large population within a small area. These masses must be distributed to their homes in a comfortable and economical manner. The way to solve this problem is to introduce an elevated system of intramural transit. The elevator has created a demand for the elevated.

Cable Grips.

The office recently opened at 18 Broadway by the trustees of the Brooklyn bridge, for the reception of models and diagrams of improved cable grips, has been well patronized. A record of all the inventions submitted is preserved in a special book. One of the most amusing communications received is that from a convict at Sing Sing. He suggests a circular track at each terminus of the bridge, so that the cars could continue on their course from one track to the other. Short cars, he adds, might be used to make the plan feasible.

Permission has been granted to the Westinghouse Air Brake Company to equip a car with their compressed air brake and a newly devised grip working on the same principle. The trial trip will probably be made within a few days. The experiment is at the company's expense. The compressed air apparatus has met with so much success when applied to surface roads, that it is expected to meet the requirements of travel on the bridge.

Governor Leon Abbett, of New Jersey, has submitted a grip very similar to that of the Westinghouse Company. These grips differ from that now in use on the bridge in being automatic in their action, while the present one is worked entirely by hand.—*Scientific American*.

Overheard in a street-car: First Lady: "Why, you know, dear, my husband is too forgetful for anything. Why, do you know, when he goes out he really don't remember where he is going."

Second Lady: "Well, all men are alike. They keep on talking and half the time they forget where they are going."

First Lady to conductor: "Stop at College Street, please."
Conductor: "Two blocks back, madam."—*New Haven News*.

Correspondence.

MESSRS. EDITORS STREET RAILWAY GAZETTE:

It is with great pleasure and profit I read Mr. A. W. Wright's articles on Street Railway Construction, now publishing in your valuable journal.

These articles are brimful of useful knowledge, gained from long practical experience and study, and are to be heirlooms for future generations of railway men. Would it not be meet and right that they should be clear at all times, and not misleading?

I trust he and you will pardon me for calling attention to a few points, which to my reading are likely to mislead:

1st. Under the head of Girder Rail, he speaks of the absence of timber stringers and immediately after quotes Mr. Moxham's tests of the Johnson Girder Rail, of which Mr. Moxham is President, thus giving the reader the impression that the Johnson system does *not* use timbers.

The Johnson system *does* use timber cross ties, and all the conglomeration of *necessary* nuisances to that system, viz.: Spikes, bolts, nuts, chairs, fish plates.

2d. The tests quoted 45 lb. steel rail, span 17 inches, ultimate strength 32,000 lbs.

What the 17 inch test is quoted for I fail to see. His timber cross-ties are laid from 6 to 8 feet apart. Would it not be better and clearer to give the test of the span actually used, so that your readers could judge of its superiority for lateral and vertical stiffness (if any) over other systems?

As these articles are to be the guide, counselor and friends for present and future railroad men, would it not be well also to show the superiority of one system over another by the *removal* of nuisances which now exist, and also of the inferiority by the *additional* and expensive nuisances which some are compelled to use in their systems?

Mr. W. knows, as well as any railroad engineer, that all these additional (now too many) accessories only tend to increase the present heavy repair account of track.

The Providence Girder Rail, while using some of the abominations above referred to, does not advocate timber, which is one important feature in its favor, although the concrete substitute brings back the first attempt of stone sleepers, which have happily been long abandoned for its great destruction to rolling stock.

Stone ties make track too rigid. Timber is perishable and needs constant repairs.

Iron hollow sleepers, after 20 years practical test in railways in Germany, France, Belgium and India, demonstrate their superiority in possessing all the requisites for elasticity, durability and true alignment of track, with little repair.

I am pleased that Mr. Wright couples the metallic system with the Cockburn-Muir system, adopted in Montevideo and other States some 10 years ago, and has given such satisfaction as to merit the title of "Admirable Construction."

Its similarity only consists in its being *all* metal.

The difference of the system being—

The Gibbon system absolutely locks all the parts of the track together, viz.: Longitudinal stringers, rails, tie rods, in such a simple and effectual manner, by simply driving a wedge key through the mortises in the stringer and girder of the rail, while the Muir system requires bolts, nuts, washers and fish plates to accomplish the same results.

Our stringer on the top is the width of the flange of the rail and has $\frac{1}{4}$ -inch batter. This batter does *not* "cause paving to be dressed to the inclination." Paving at the best has more than $\frac{1}{4}$ -inch joints. I trust Mr. Wright will note this fact.

Since I wrote him last January, I have laid about one mile of track in this vicinity, 1,500 feet of which was laid by five men in 30 hours, ready for the pavers, the material all being distributed on the side of the street.

In conclusion, I shall at an early date send Mr. Wright tests of our rail and stringers, with the spans (30") as actually laid, and I trust that all systems claiming to be in advance of the timber system will do likewise, so that those contemplating building railroads, can form a correct judgment as to the superiority, for cheapness, strength, easy rid-

ing, durability, rapidity in construction and with the least amount of repairs in the future. These are important items and which every railroad official would like information upon.

Yours respectfully,

THOS. H. GIBBON.

[The above letter was received too late for the June number of the STREET RAILWAY GAZETTE. The editors thank Mr. Gibbon for his kind expressions regarding the papers appearing monthly in our columns from the pen of Augustine W. Wright, and are obliged for his criticisms. We would be pleased to have the views of others differing from Mr. Wright.]

Replying to Mr. Gibbon's letter *serialim* :—

The Johnson Girder Rail Company do make metal cross-ties and furnish an entire metal structure, if so desired by the street railway company; but Mr. Wright considers a wooden cross-tie preferable, all things considered, an opinion evidently coinciding with that of street railway men generally, as proved by their practice.

The tests quoted by Mr. Wright are for a girder rail and stringer construction of the *same span*. Why Mr. Moxham chose this span is unknown to the editors. The editors fail to see wherein the Gibbon system, carried in cast-iron stringers, resting upon concrete, has a more elastic foundation than the Providence Girder Rail construction, also resting upon concrete. As a matter of fact, not a little difficulty has been experienced abroad from the wear of keys and wedges in such systems as those of Mr. Gibbon, but, all things considered, the Cockburn-Muir system has stood the test of time, "which tries all things."]]

Triumphant Democracy.

Mr. Andrew Carnegie, who was born a British subject and subsequently became an American citizen, has written a book with this high sounding title. While he pats the British lion on the back, he causes the American eagle to soar supreme in the empyrean. The wonderful material progress of America has been pictured in strong colors by this millionaire writer. He draws attention to the wonderful growth of the great cities of the country, such as Chicago, Pittsburgh, San Francisco and Duluth. To those who engaged in the development of the cities of the country, and particularly to those who are concerned in furnishing them with proper intramural transit, all these actualities and possibilities will be intensely interesting. In fact, all citizens should honor, and knowing should take pride the rapid progress that has been made. For the last forty years, at least, everything has conspired to produce this wonderful growth. Boundless land and infinite possibilities of commerce have attracted numberless immigrants to this land, a land regulated and governed by a just system of laws, that are enforced by competent courts. This development, that has gone on so rapidly, has not only accumulated material, but also intellectual wealth. Schools, colleges and all kind of institutions for learning are scattered throughout the land.

America is particularly rich as an agricultural community, and it is known that upon agriculture all actual wealth depends. Everything, after all, originates in mother earth. While in 1880 the United Kingdom, with 12,500,000 acres, produced 500,000,000 bushels of grain, and Russia, with 158,000,000 acres, produced only 1,500,000,000 bushels, the United States, with 118,000,000 acres, produced over 2,500,000,000 bushels. In 1860 the United States exported wheat and flour worth \$7,000,000; in 1880 they exported \$38,000,000 worth, of which England took \$35,000,000 worth. Mr. Carnegie claims that we are the greatest manufacturing and mining nation in the world. His figures are \$1,100,000,000 worth in the States, as against \$800,000,000 worth in England. America is running England hard in iron and steel. In 1881 we produced 1,374,000 tons, against 1,780,000 tons in the United Kingdom, whereas in 1870 the figures were 64,000 tons, against 245,000 tons. In cotton, the total consumption in England was, in 1870, 1,100,000,000 pounds; 1880, 1,404,000,000 pounds; in this country, 1870, 53,000,000 pounds; 1880, 961,000,000 pounds. In woolen industry, England turned out 338,000,000 pounds; America 320,000,000 pounds. The United States produce more gold than

Australia, more silver than Mexico and Peru, more copper than Chili or Spain, more lead than England or Spain, and in addition to all this, the United States have 300,000 square miles of coal field, against 12,000 in England; and, moreover, the Pennsylvania factories use the product of petroleum-gas, while in the earth, which requires only sinking for.

When we consider that all these natural advantages are spread over an area nearly as large as the whole of Europe, and ranging from the Arctic to the Torrid Zone, it is not surprising that the industries of the United States should have flourished as the author has described.

Mr. Carnegie does not seem to admit the anomalous position of this country in its relation to the foreign commerce of the world. "The whole foreign commerce of this country is only one-sixth of the home commerce of the States." The tonnage of American ships engaged in foreign commerce was only 1,250,000 tons, but the tonnage engaged in domestic commerce is 2,750,000 tons, or in all, 4,000,000 against England's 7,000,000 tons. The governmental policy under which our commercial marine will be developed is not indicated by the author.

We are possessed of free trade over a continuous territory as large as Europe. We are not burdened with an enormous, unproductive expenditure on a standing army. We enjoy an absolute self and local government. We spend \$18,000,000 a year on education, and this vast amount grows at the rate of \$1,000,000 a year.

With all this accumulation of realized wealth and extension of education, let us increase the efficiency of labor by giving technical and economical instruction to our workmen, who, with better homes and better facilities of rapid transit in passing to and from their habitations, will feel that American democracy is at last triumphant.

Beecher on the Brooklyn Street - Car Tie-up.

In referring to the great tie-up, Mr. Beecher recently said he was very glad to see the cars running again.

"If the infernal fools who ordered the cars to stop should run on and never stop, it would be a good thing for the country. I am a child of labor. My ancestors were brought up to it, and no subject is nearer to my heart than the elevation of the ignorant and the raising of the laboring-men. I sympathize with all the efforts and associations of laboring-men, but I am bound to say that the methods and secret policy of those who profess to be helping laboring-men should put to shame all honest men. After fair debate and open discussion every citizen must yield his will and private judgment to the majority, for on that foundation all free government stands. When men gave up their right to debate and handed over their judgment and conscience to men elected to represent them, a mere handful of men chosen to hold the judgment of thrice ten thousand men, not one in fifty of whom was not fully satisfied, it was outrageous and unreasonable. The men walked out and did not know why."

It was a shame, in Mr. Beecher's opinion, that private judgment and choice should be given up in such a manner. It was a lasting degradation to tag along as a dog after a hunter, not knowing whither they were going.

"I protest," said Mr. Beecher, "against any such working principle as deprives men of perfect liberty. The sons of labor as organized meet and resist the arbitrary demands of capitalists, and they say to men at work, 'You shan't work as you please.' They do to the class beneath them just what they complain of in the class above them. This is tyranny the most despicable known in history. I object to the abolition of individualism—to the turning of men into wheels of machines. Unless the Lord has forgotten the world, they will go to smash unless to reformation."

Mr. Beecher said he had spoken of these things because he might drop dead and not have a chance to say them. If any class had a real grievance there was power in legislation to meet it.

Lasalle Street Tunnel.

The City Council passed an ordinance on July 6th, giving the North Chicago City Railway Company the right to operate cable cars in the Lasalle Street tunnel. The company pays \$20,000 for its use, and all charges for repairing, lighting and ventilating the tunnel are to be defrayed by the city, by deducting the same from the said rental. If a dispute occurs as to these expenses, the matter is to be settled by arbitration. The council by passing this ordinance has simply done an act of justice to the people they represent. The tunnel was built for the benefit of the public and the best way to give the people an opportunity to use it, is to allow cars to pass through it.

Upper New York.

For a number of years that part of New York that lies north of Fifty-ninth street was unbuilt upon. While the ground lying on both sides of the Central Park, Harlem, Camansville, Washington Heights and Morrisania remained in vacant lots, the tide of humanity flowed into Long Island and New Jersey. To accomplish this it was necessary to cross two large fast flowing rivers, but as the suburban steam roads encouraged the settlement of the sections through which they passed and offered great inducements to persons seeking better and cheaper homes, large numbers of people left New York, many of them to take up their residences in the state of New Jersey. Upon reflection it will be perceived that the course of the least resistance was followed for to continue in New York meant either crowded and unhealthful habitations, or an onerous and disagreeable travel across the long narrow island.

But at last a great change took place when the elevated roads were built. The story is well known. The portions of New York referred to are now being improved with most wonderful rapidity. The appreciation of real estate and the general growth of that city cannot be equaled in grandeur and rapidity by anything that has occurred in ancient or modern times. Boulevards, paved streets, palatial residences, commercial buildings and churches of medieval magnificence are springing up as if they were produced by the wand of a magician.

The question that has occurred to us is, whether the large cities of the West will speedily profit by the lesson that may be derived from a study of the practical result of the metropolitan development we have described.

I AM fond of taking an evening "drive" on the street-cars, but the pleasure of these jaunts is very much reduced by three nuisances, which I never expect to see abated, though they ought to be. The first of these is the man who rides on the bottom step of the platform of the car. To board the car without stepping on this fool's foot is the first trial I meet with. If he were always a small man with a hollow chest, I should simply step on his foot and climb over his shoulder, anyway that was most convenient; but alas! he often measures six feet and has mischief in his eye. This alters the case. The second nuisance I encounter is the man who spits. By what sad fatality I always get a seat at his side I cannot understand; and still less can I comprehend how it is that he always gets between me and the wind. He never exactly spits on me, but every time he spits the spray is wafted on my face. I have never struck him yet, but if he is old and feeble he had better look out. The third nuisance is the smoker. He also always rides to the windward of every one else, smokes a cob pipe or the meanest of five-cent cigars, and sends a trail of smoke all through the car behind him. If I had my way, I would build seats on the top of the cars, as they do in Europe, and compel the smoker to sit up there, summer and winter. I am not in favor of hanging, except for murder.—*Exchange.*

THERE are 233 towns in this country in which horse street railways are used. There are required to conduct this industry 16,843 cars, 84,577 horses, and 3,340 miles of track.

Vetoed.

The obstruction to the much needed legislation to authorize the use of the LaSalle Street tunnel by the North Chicago City Railway Company, which the Mayor has placed in the way by his veto, does not in our opinion voice the true interests of this city.

This is the old story of one man determining that he is wiser than the many, and this single official sets himself up as the judge of the law, the form and the substance of the proposed ordinance. If space permitted we could show conclusively that most of his objections are frivolous.

The truth is that the tunnel is quite useless in its present condition; that it could be built for two-thirds of the first cost of the old work; that the grade could be made much easier and the approaches shorter, but the railway proposes to use the tunnel with all its disadvantages for the benefit of the public, and we would suggest that instead of requiring the railway to pay a rental, that the city should pay one half of the cost of the necessary repairs to put the tunnel in a condition to be used.

But the most extraordinary feature of the Mayor's action is that he has prepared an ordinance for the council. Why not leave the whole matter to the Mayor and thus relieve the council of all trouble in the premises. Then the Mayor, at least, would be satisfied.

Mexican Mules on Street Cars.

One of the thirteen little Mexican mules purchased by the Street Railway Company is very unruly. To put it mildly, he is a "holy terror." He is small in size, yellow in color, and gentle looking in appearance, but in reality he is very, very wicked. He was hitched to a car alongside of a big-eared mule. The trip from the stables at the lower end of Franklin street to the termination of the line at the corner of Main and First streets was not a pleasant one by any means for the poor driver. The stubborn mule wanted to go in every direction but the right one. He made several attempts to haul the car and his mate down side streets. A few times he stopped and could scarcely be budged. At last, however, the end of the first half of the trip was reached.

A circus occurred at this point. While the mules were being changed from one end of the car to the other to make the return trip the little Mexican plug got wrathful and made things for a short time howl. He jumped, kicked, rolled over and over, broke loose from the other mule, and made several circuits around the car with the driver holding on to the lines for dear life. He then started up Main street at a wild rate of speed, dragging the driver behind him, but the driver would not let go the lines. The scene created considerable excitement and fun before the little beast was stopped and returned to the car. The employes of the lines threaten to strike if these mules persist in their deviltry as they did yesterday.

One hitched to a Second street car executed a number of acrobatic feats at the corner of Main and Second streets, such as trying to kick the driver's hat from his head, trying to walk backward through the car, standing on his head, and terrifying a number of ladies.—*Evansville Journal*.

The illustrated papers show that when Ald. Jaehne arose to receive the sentence of the court he stood with one hand behind him. Even under the stern eyes of justice, the Alderman did not forget his business instincts.—[*Arkansas Traveler*.] No member of the New Orleans City Council, thank fortune, stands with one hand behind him while he is speaking on the question of giving away a valuable franchise. The man above suspicion uses one hand to steady himself by his chair, while he paws the air with his other hand.

We desire to acknowledge the receipt of the "Verbatim report of the fourth annual meeting of the American Street Railway Association," held at the Southern Hotel, St. Louis, Mo., in October, 1885. This is an important contribution to the literature of city transit.

New York Arcade Railway.

The Directors of the New York Arcade Railway Company met in the company's office, July 13, and elected the following Executive and Finance Committee: C. A. Arthur, C. N. Bliss, Melville C. Smith, W. H. Wickham, John O'Brien, Ed. B. Thomas and George Cecil. The committee met immediately after the election and discussed several propositions from contractors for building the first section of the road. The shortest time for completing the road to Forty-second street or Fifty-ninth street, according to these propositions, is two years.

The plans place the cost of the road at from \$3,000,000 to \$4,000,000 per mile. The Executive Committee adjourned without taking further action until Thursday, July 15, when the financial arrangements will probably be considered.

New Corporations.

Incorporation licenses were issued, July 13, to the following companies by the Secretary of State:

The Chicago Suburban Transit Company; capital stock, \$5,000,000; incorporators, John Thomlinson, Allan C. Knapp and James M. Bryant; to construct elevated railroad, electric light and telephone lines from Chicago to Lake View, Ravenswood, Rogers Park, Evanston, Hyde Park, Lake, Pullman, South Chicago, Hegewisch, Lawndale, Crawford, Oak Park, Austin, Lake View and Minonk.

A PAPER upon the merits of metallic railroad ties was read at a recent meeting of the French Society of Civil Engineers. The author based the advantages claimed for them upon actual trial of twelve years' duration. The trial was made in Germany, and proves them to be:

1. More durable than wooden ties.
2. Safer than wooden ties because the gauge is better preserved.
3. Less expensive after the second year of service, while wooden ties grow more costly with years.
4. The fastenings more certain and less expensive for repair.
5. More valuable when worn out in service than old wooden ties.

Mr. Post, the author, claims, in summing up, that no country can use wooden ties instead of metal with true economy. He cited Holland as proof, for wood in Holland is cheap and plenty, while iron is scarce, comparatively speaking.

A WELL-KNOWN author in a street car, rising and giving his seat to a stout woman, who does not acknowledge the civility—"I'm obliged to you, madam." Stout woman (flushing angrily)—"For what, sir?" Gentleman (courteously)—"For taking my seat." Hilarity among the other passengers.

REPORTER—"Are you going to work to-day, Pat?" Pat—"Sure, I dunno. Me old woman says she'll break me head if I don't, and the union men will break me head if I do. Sure, these are hard times for dacint men. I think I'll take me chances with the old woman."—*New York Times*.

SHOULD the Chicago Council favor the tunnel proposition, it will necessitate the expenditure of fully four millions of dollars to change the forty miles of track now in use to a cable system. Probably seven-eighths of this large sum would be expended in that city for labor and material.

THE New York newsmen have undertaken a big job in trying to regulate the universe. They are boycotting the World and trying to sell out the Stars and the Sun.

ROSCOE CONKLING got \$20,000 for prosecuting the New York aldermen, which was as much as any of them got. Honesty, children, is the best policy.

MOTTO for the South Side cable road: "God bless our Holmes."—*Chicago Evening Journal*.

Personals.

PROF. P. H. VANDER WEYDE.

Prof. P. H. Vander Weyde is now President of The Polytechnic Association of The American Institute. His attention is being given to the merits of electric motors.

PETER A. B. WIDENER.

Peter A. B. Widener is the street-car magnate of Philadelphia and is the central figure in the syndicate of Philadelphians now operating in the street-car field in Chicago. There could not be two men more closely associated in business or more congenial in tastes and pursuits than Peter A. B. Widener, President of the West Philadelphia Railway Company, and W. L. Elkins, of the Continental Branch of the Union Railway of Philadelphia.

MRS. LETITIA V. VREDENBURGH.

Mrs. Letitia V. Vredenburg is the Treasurer of the New Albany (Ind.) Street Railway Co. It is said that she is the principal owner of this road.

DEWITT C. CREGIER.

DeWitt C. Cregier, Superintendent of the West Division Railway Company, presented, June 28, to the City Council an ordinance for the introduction of its cable system on the West Side. The system proposed is totally unlike that in vogue on the South Side, and Mr. Cregier proposes to give the Council and West Side residents an opportunity to test its workings by laying a quarter of a mile on an unoccupied street.

CHARLES W. SCARFF.

Mr. Charles W. Scarff, of Grand Island, Neb., one of the projectors of the new city railway of that place, was one of our recent callers.

CHESTER A. ARTHUR.

Ex-President Arthur was elected July 8, President of the Board of Directors of the Arcade Railway Company. Vice-President Smith says that he has received a telegram from Mr. Arthur which states that he is very much improved in health, and that he expects to take energetic part in the affairs of the company.

OBITUARY.

Mr. David Van Nostrand, so long and so favorably known throughout the country as a publisher of engineering, mechanical and scientific publications, died at his home, No. 23 W. 20th Street, New York City, on Monday afternoon, June 14.

Pointers.

ALABAMA.

Huntsville.

The Huntsville Street Railroad Company has been incorporated with a capital of \$100,000. The incorporators are Lawrence Cooper and William Leedy.

COLORADO.

Los Angeles.

Work was begun to-day at the corner of Main and Pico streets for the Pico-street branch of C. H. Howland's electric street railroad system. The branch will be about three miles long, and is to be completed in ninety days. The cable railroad has laid out a park with a lake in it as an inducement to people to travel on its line.

San Francisco.

A franchise for a new cable road across the city has been granted, and the road will be built without delay.

COLORADO.

Denver.

The Denver City Railroad Company, has recently built extensions on Broadway to the city line, and on Deer street to Capitol hill. Other extensions are under consideration, and the stable is to be enlarged, being now crowded with 275 horses and 51 cars.

DISTRICT OF COLUMBIA.

Washington.

The traction railroad bill, which proposes to

grant a charter for a cable road, and give the right of way over more than 30 miles of streets, is vigorously opposed by all owners of stock of the present horse railroad. The bill was laid over in the House after a heated debate.

GEORGIA.

Macon.

The Gilesville extension of the city and suburban street car line has been completed as far as the tunnel under the Georgia Central R.R. on Fourth street.

Rome.

The capital stock of the new street railroad company is \$50,000; it is proposed to issue \$30,000 in first mortgage bonds, bearing interest at 6 per cent. The contract for construction has been let to Judson Kingsley, of Troy.

ILLINOIS.

Bloomington.

Bloomington citizens are now asking for a street-car line to their cemetery.

Chicago.

The Chicago Passenger Railway Company will soon commence laying tracks on Washington street, from Michigan avenue to Franklin street, also on Franklin street south to Harrison and across the Harrison street bridge.

The stockholders of the North Chicago City Railway company have unanimously confirmed its lease to the North Chicago Street Railway company.

The Dearborn Street Union Railway Company has taken out its certificate of incorporation, with a capital stock of \$100,000. The incorporators are Eugene S. Pike, Lazarus Silverman, John T. Dale, Andrew Crawford, Joel Bigelow and Albert J. Averell. They claim to have obtained the consent of proprietors of 500 feet more than a majority of the street frontage. The company intends to begin work upon the Council for an ordinance at once, and hope to lay the tracks this Summer or Fall. There is some talk of donating one-tenth of the stock to the Board of Education for the benefit of the school fund, as it owns more than half the frontage between Madison and Monroe streets. The new line will charge 3 cents fare.

Property owners in the southern part of Chicago are likely before long to be in a fever over a scheme for the construction of an elevated railway, though just where it is to start and where it is to end seems for the present a very indefinite matter. This much is known, that it is proposed to run a line in between Calumet and Prairie avenues, and some progress has been made in securing the consent of abutters. Another idea, which, however, does not seem to find much favor with the projectors of this scheme, is to run the line parallel with the Illinois Central and near it. The schemers also have an eye on Butterfield street.—*The Age.*

Pres. C. B. Holmes informs us that the Chicago City Ry. Co. has commenced a very important extension of its cable road along State street, commencing at 39th and ending at 63d street. The boilers and engines have already been purchased. The new boilers and other necessary machinery will be placed at a point about half way between these two points.

The Citizens Street Railroad Company has elected the following board: President, W. V. Cannon; Vice-President, W. Stewart; Secretary and Treasurer, A. R. Samuel; Directors, A. C. Daniel, J. B. Mann, J. G. Holden, E. C. Abdill.

The Chicago Cross-Town Street Railway company, at a meeting recently at No. 352 Blue Island avenue, instructed its attorney, Mr. J. W. Ryan, to apply for a state charter. The projected route is from Ashland avenue along Taylor street (by a bridge) to State street, along State to Fourteenth street, and thence to Union, along Union to Twenty-second street, and thence to State street. The incorporators are J. J. Curran, George P. Bunker, William Solan, P. C. Harrigthy, James Crowe, J. B. Ryan, and another. Most of them live on Fourteenth street, and it is understood that the property owners

along the projected route owning twenty-four feet frontage have been promised a share of stock for each twenty four feet. The projectors appear sanguine of obtaining a city franchise after the charter has been granted. Only the six prospective incorporators were present.

Citizens of the Fourteenth Ward, who want a street railroad communication with the North side, have induced the West Side and North Side Railroad company to build a road, provided the right of way is granted. The citizens are very anxious to have the road built this summer.

So jubilant are the people of Jefferson benefited by the new line of street-cars on Division street, west of Milwaukee avenue, that a large delegation of woman came down to the Jefferson car barns yesterday and elaborately decorated car No. 486, which made the first trip over its new line. The driver, Thomas Callahan, was loaded down with flowers, and crowds of men, women, and children followed the car shouting and making merry.

The stockholders of the Union Elevated Railway held a meeting yesterday afternoon in the office of M. B. Bailey, in the government building, and elected the following officers for a term of one year each: President, Philip A. Hoyne; treasurer, Michael C. Ryan; secretary, Edgar T. Paul. A committee was appointed to lay out the route of the projected railway. It is designed to build the first line on Milwaukee avenue extending to the city limits, and it is claimed that nearly three-fifths of the property-owners on that thoroughfare have already given their consent to such an arrangement. A petition will be circulated for the signatures of the property-owners to be presented to the city council at the proper time. It will be directly above the middle of the street, so that there will be no darkening of windows. The estimated cost of building the road is \$300,000 per mile.

The Union street railway of Chicago has been incorporated, to construct, own, lease and operate street railroads in Cook county, Ill. Capital stock, \$100,000. Incorporators, John E. Barns, Charles Ford and Henry P. Krantz.

The Arcade Rapid Transit company of Chicago; capital stock, \$1,200,000; incorporators, Samuel L. Whipple, Charles H. Crawford, Thomas A. Cantwell and John Gibbons.

To meet the objections of certain property-holders on Sedgwick and Larrabee streets to the cable system the aldermen recently discussed the proposition to lay a single instead of a double track on the streets in question, and to operate the cars on the loop plan. The objection urged to the cable so far has been that it would take up too much of the street space, which the laying of a single track, it is urged, would remedy. Under the loop plan the cars would go up one street and down the other, but whether this would satisfy either the kickers or the railway company is not known. If the loop plan would work on these streets, however, it would certainly work on others, especially on Clark and Wells streets, and the question may be worth careful consideration.

The Chicago West Division Railway company yesterday commenced running its cars over the Halsted street viaduct, the work on which has been practically completed. It also commenced the operation of its new line on Eighteenth street, between Halsted street and Ashland avenue, which will be extended to Leavitt street as soon as the street improvements are out of the way. The new line will run down town on Madison street for the present.

The North Chicago City Railway company yesterday commenced laying double tracks on Market street, south from Chicago avenue, under an ordinance passed some months ago. The announcement caused quite a flutter at the city hall, the idea having gotten abroad that the company had commenced putting in its cable system. Supt. McGann was soon on the ground, and subsequently reported that there was nothing wrong about the work except that the engineer in charge had omitted to get a formal permit to occupy the street, which will be remedied. The new line will come as far south as Michigan street, with single track switches on Illinois and Michigan streets to connect with Wells, the idea being to better ac-

commodate the people west of Market street and also to somewhat relieve the pressure on Wells street.

Corporations were licensed by the Secretary of State, June 10, as follows: The Union Electric Company, at Chicago; capital stock, \$250,000; incorporators, William F. Stewart, A. T. Rice and Charles W. Blattner. The Union Street Railway Company, at Chicago; capital stock, \$100,000; incorporators, John E. Barnes, Charles Ford and Henry P. Kranz.

An application was filed in the office of the Secretary of State, Springfield, July 6, for articles of incorporation for a company which proposes to construct an elevated surface or underground railroad to be operated by electricity. The general scheme is to construct an elevated road and give the city the benefit of rapid transit, but the other powers are asked for as a modification of the proposition may be ordered by subsequent legislation. The incorporators are, Mr. John Thomlinson, of the firm of Thomlinson & Co., cut stone contractors; James M. Bryant, of the Board of Trade, and Allen C. Knapp, secretary of the Board of Trade Telegraph Company. Mr. Thomlinson states that all the money required to construct an elevated road from Thirtieth street on the South Side, to Lake View on the North Side, has been pledged by prominent capitalists. The alleys will be utilized as far as possible, and on the South Side the road is to be constructed between Wabash avenue and State street. The river should be crossed about Dearborn street and the road proceed to Lake View via the thickly settled districts in the neighborhood of Clybourn avenue. It is estimated that the cost of the entire line would be about \$10,000,000, although the capital stock of the new company has been put at \$5,000,000. It is intended to make the elevated structure of a highly ornamental and substantial character. The time of passage from Lake View to the center of the city would be about twenty minutes, and from Thirtieth street to the river in about the same period. It is claimed the railroad would be a success from the start, as rapid transit is much needed in a city spreading over so large an area as Chicago. Charter privileges will be applied for at an early day.

It will be good news for the citizens of the Northwest Side as well as those of the North Side to hear that after years of waiting they will in all probability soon have direct horse-car connections between the North and West Sides of the city on Division street. The agitating committee appointed at the last meeting of the Citizens' Association of the Northwest Side, Messrs. C. P. Rose, C. F. Lichtner, and Daniel Roth, succeeded in getting the approving signatures of the majority of the property-holders along the route of the road in question in spite of the strong opposition raised by a few large property-holders. The property-holders of the Northwest Side, as well as of the North Side, will send a delegation to the next Council meeting to urge the passage of an ordinance granting the right of way on Division street across Goose Island to the North Chicago Street Railroad Company, which will commence to lay tracks soon as the ordinance is passed.

IOWA.

Oskaloosa.

The street railway at Oskaloosa will not be put in operation before Oct. 1.

Des Moines.

The Des Moines Street Railway has been sold to a syndicate for the sum of \$225,000.

The city council this afternoon passed the charter for a broad gauge street car line. As several citizens have secured an option to purchase the existing street car service, there is an undercurrent of speculation as to whether they will consummate their purchase or whether the new charter is something of their devising.

KANSAS.

Wellington.

The new street railroad at Wellington is working satisfactorily.

LOUISIANA.

New Orleans.

On the 24th ult., in the Louisiana Legislature the subject of regulating the hours of labor on street railways was made the special order for July 1st.

MASSACHUSETTS.

Asbury Grove.

The Nauskeeg Street Railroad Company has purchased an acre of land, with a frontage of 103 feet, opposite the Retreat, and will build a stable and car shed.

Boston.

There is a proposed consolidation scheme, which will include the Highland, Middlesex and Charles River roads, and the lease of the South Boston line by the consolidated company. The Middlesex has proposed to lease the South Boston, the consolidated company guaranteeing 10 per cent. Committees have been appointed to consider the proposition, and the terms, which have been substantially agreed upon, provide that the Highland stock will be put at \$140 per share, Middlesex at \$115, and Charles River at par, \$100. It is probable that President Powers, of the Middlesex, will be president of the consolidated company.

The Legislature declines to advance the elevated railway project this year. Adverse reports on the several propositions submitted during the past few months were made in both branches on the 3d inst., and, as the committee is unanimous in its opinion, further agitation is not likely, and the whole subject will go over to the next General Court.

Arthur F. Gould vs. Eastern Railroad Company. This is a petition for the appointment of commissioners under chapter 360, acts of 1873, to assess damages for the taking of land in Charlestown, being the fee in First Street of passageways laid out between said First Street and Second Street, and between First Street and Austin Street. This case turned upon the question whether the deeds of the Charlestown Wharf Company, prior to the deed to James Gould, dated Oct. 19, 1844, conveyed the fee in the said streets and passageways to the several grantees. The court found that they did, and so dismissed the petition with costs.

Haverhill.

The extension of the Haverhill and Groveland Street Railroad to West Newbury was opened June 17.

New Bedford.

The Acushnet Street Railroad Company, having laid a turnout on Cedar Street, against the orders of the aldermen, the mayor had the track torn up. Much ill-feeling has been caused.

North Adams.

Work on the street railroad has been commenced. The route is for the greater distance along the side of the road, but in Adams village it will be laid in the middle of the road. J. D. and D. S. Haines are in charge of the work. The rails, which have been ordered, are of new steel, heavy enough for freight business.

Pittsfield.

The street railroad company has bought a site for the stables, which will be 30x100 feet, with a car shed 40x100 feet; D. C. Munyan is the contractor.

Winchester.

The North Wolrun Street Railroad Company proposes to lay tracks here.

Winthrop.

A dispatch of June 26 says: This week has been a most eventful one in the history of this little town. Yesterday Governor Robinson signed the charter for the Winthrop Electric Street Railway Company, which is the first charter granted in the State of Massachusetts for an electric railway, and the first ever granted in the world for an electric elevated railway. The citizens of Winthrop may well feel proud, and last evening they celebrated the event by a display of fireworks and a band concert in the public square. E. H. Doolittle, the originator of the electric scheme, has shown the most indomitable pluck in the way in which he has fought all opposition to this new mode of transit. The direc-

tors are Erastus H. Doolittle, John A. Enos, P. S. Macgowan, C. A. E. Erving, Walter Lawton, S. A. Freeman and Thomas N. Dwyer.

Worcester.

The Citizens' Street Railroad Company has engaged Charles F. Heath, late car starter for Lynn & Boston Railroad, as superintendent.

MICHIGAN.

Detroit.

The Detroit Electric Railway Company has been incorporated by Henry M. Campbell and others, with a capital stock of \$25,000.

MINNESOTA.

Minneapolis.

The street railway company will soon lay a double track on Plymouth avenue.

A strike of street-car employes in this city has been adjusted by the company acceding to the terms of the men.

Stillwater.

Messrs. Kiltz and O'Neal have abandoned their street railway project, and the opposition company has now nothing to interfere with it, and will probably proceed at once to build its road. This company has been incorporated by E. S. Brown, G. A. Torinus and others, with a capital of \$100,000.

St. Paul.

An inclined plane is proposed on the steep grade from Pleasant avenue and Fifth street to the junction of Summit and Selby avenues. Street cars and road vehicles will be driven on to a platform which will be hauled up the plane by a cable driven by steam power. This plan is in operation at Cincinnati, Kansas City and elsewhere.

MISSOURI.

Kansas City.

A meeting of the stockholders of the Kansas City Electric Railway Company was held on June 4, at which William Chrisman and Warren Watson were chosen temporary Secretary and Treasurer. The following Board of Directors was elected: William Chrisman, W. W. Kendall, W. E. Winner, H. L. McElroy, W. Watson, Theodore S. Case and Benjamin Estill. The company is now on a good financial basis, and will commence operations as soon as the council will allow them. At the next annual meeting of the council an ordinance will be introduced permitting the erection of poles on East Fifth Street, from Grand to Lydia Avenue, and as soon as such permission can be obtained work will be begun. Mr. Henry, the inventor of the motor, and electrician for the company, has come East to purchase machinery.

Work has already been commenced on the Ninth Street extension of the Kansas City Cable Company, and operations were begun on the Troost Avenue line on the 10th inst. Work will be commenced at Springfield Avenue and pushed north as rapidly as possible.

A sale was made to-day of Corrigan's interest in the Corrigan Consolidated Street Railway Company, in this city, to a Boston syndicate. Eighty-three hundred shares were purchased for \$830,000. The transfer includes the several lines of horse cars now in operation, and franchises for the cable roads to build on Fifth, Twelfth and Eighteenth streets. It is stated that these projected lines will soon be built by the new company, and all the roads thoroughly equipped.

St. Louis.

A dispatch of June 14, from St. Louis, says: There will be introduced into the House of Delegates to-morrow evening a bill authorizing the construction and maintenance of an electric elevated railway, double track, standard gauge, with sidings, turn-outs and buildings. The franchise will be asked by Thomas O'Reilly, his assigns and successors. The termini of the road will be at Fourth Street and Forest Park, the distance between being about four and a half miles. The bill provides that the road shall be constructed as nearly as possible over the middle of the streets, upon machine wrought iron, and the motive power shall be electricity only. Mr. O'Reilly

says that Eastern capitalists will furnish the money, and will commence the construction of the road within a week after the passage of the bill.

The Cass Avenue and Fair Grounds Railroad Company will re-lay the entire 7 miles of track with the Johnson steel girder rail.

The mayor of St. Louis has vetoed the elevated road bill recently passed by the municipal assembly.

* * *

NEBRASKA.

Grand Island.

The City Railway Company of this place has been incorporated with \$25,000 capital. The company has exclusive right on the streets named for twenty-five years. Directors: H. A. Koenig, C. W. Scarff, O. B. Thompson, I. R. Alters, O. A. Abbott, H. A. Baker.

Omaha.

A number of capitalists propose to construct a bridge to cost about \$250,000 over the river from Council Bluffs to Omaha, and run a line of cable cars across it. It will also be constructed to accommodate foot passengers.

Omaha adopts the cable street railway system.

The Omaha Cable Railroad Company has completed the purchase of material for two miles of track, to be completed by November 1. The contract for the ironwork, exclusive of rails, amounts to \$60,000.

* * *

NEW JERSEY.

Orange.

The Orange Cross-town and Orange Valley Horse Railroad Company's ordinance provides for a single track with turnouts, the construction to be approved by the Council Committee on Railroads. Cobble stone paving between rails on macadamized streets and with Belgian blocks within four years, iron bridges across gutters, 5-cent fare, 12 hours to constitute a day's labor for the employees, road to be completed within a year and a-half, and the company to pay a license of \$3 per car for the first three years, \$5 for the next three, and \$20 per year thereafter.

* * *

NEW YORK.

Albany.

The Albany Railway Company has decided not to accept the proposition of the Albany and Greenbush Railroad Company to sell its road for \$25,000.

Brooklyn.

The Union Elevated Railroad Company has been incorporated by the Fifth Rapid Transit Commission. The capital stock is \$1,000,000, and all the stock is taken. It comprises ten routes: 1, Fulton street from Fulton Ferry to the city line; 2, intersection of Fulton and Flat-bush to the new Utrecht line; 3, tunnel route from Fifth and Prospect avenues; 4, Myrtle avenue from Fulton to Grand; 5, Myrtle from Grand to Broadway and city line; 6, on Nassau street; 7, on Broadway; 8, Franklin and Myrtle avenues, over private property, First street to Grand street and Greenpoint; 9, on Adams, Sands and Washington streets; 10, Hudson avenue from Fulton to Park. The first to be completed are Nos. 1, 4 and 7, by August, 1888, and the last No. 5, city line extension, by August, 1891. The Commission was composed of Wm. J. Osborne, John F. Owings, George W. Anderson, Richard Lacy and Charles F. Tonjes. The Long Island Elevated Railway Company has also been incorporated. Its stock is equally divided between the Long Island and Atlantic Avenue Railroad companies.

The Brooklyn City Railroad Company has decided to put open cars on the Flushing avenue line. In order to do this they have been obliged to put in new switches and tracks on Fulton street near Sands street.

Brooklyn may safely claim a population of 770,000. Two independent estimates agree within 3,903 of each other. With the exception of one elevated railroad transit, not very rapid sometimes, is limited entirely to horse cars.

The total bridge receipts for June were \$62,462.59

Coney Island.

The Coney Island Elevated Railroad has been incorporated as the Sea View Railroad Company by Frederick Schroeder, James Jourdan and others. Capital stock, \$250,000.

Jamestown.

The Common Council, after very lively debate, has granted the right of way to the street railroad company whose tracks they recently tore up.

New York.

Deputy Attorney-General Poste, who has charge of the Broadway Railroad suits, left for Albany last week, leaving instructions that all letters should be forwarded to him. At his office at 71 Broadway it was said that he had started for the Adirondacks on his vacation, and that nothing would be done in the Broadway suits till the courts open in the fall.

Deputy Controller Richard A. Storrs has received from Thomas F. Ryan, Treasurer of the Broadway and Seventh Avenue Company, a certified check for \$40,000 in payment of the first year's rent for the Broadway Railroad franchise.

The suit brought by Corporation Counsel La-combe on behalf of the city was for the purpose of securing the payment of this \$40,000. The money having been paid, the suit of the Corporation Counsel naturally rests. By this payment the city secures the full rental without deducting the fees, which Receiver John O'Brien would have charged had the amount passed through his hands.

The large horse car stable of the Forty-second St. and Grand St. Ferry line, at the foot of West Forty-second street, was burned June 12. When the flames were discovered there were 700 horses and 57 cars in the building, beside a large amount of hay and feed in the upper floors. All the animals were removed except five which were in the hospital. Five cars were lost. The building was erected at a cost of \$100,000, and was insured for that amount.

In passing sentence on a Third av. railroad striker Judge Cowan made the following remarks: "When you undertook to say that a man shall not work unless he identifies himself with your organization you struck a blow at liberty and the principles so dear to us all. Because I think that those behind you are much more guilty than you are I will be lenient toward you. I think that the issue in which you engaged was not one of capital against labor, but rather of law and order versus lawlessness and disorder."

His Honor then imposed a sentence of six months in the penitentiary.

The New York & Brooklyn Bridge extension will soon be completed. Workmen are now busy erecting the iron work on the New York side, and the Third Avenue Elevated Railroad station is being changed to suit the bridge railroad track.

The plant for operating the two cables of the Tenth Avenue and 125th Street Cable Railroad, consists of: Four steam boilers, 125 horse power each; two steam engines, 300 horse power each; with fly wheels eighteen feet diameter, weighing 40,000 pounds; four pairs of driving drums; two pairs for Tenth Avenue and two pairs for 125th Street line; two cables now in and one in operation on 10th Avenue. Each cable is 33,000 feet long and weighs 85 000 pounds. The cable moves at the rate of eight miles per hour, and is capable of hauling the entire length of the road, covered with the largest cars loaded, placed at intervals of one minute apart. Each new car seats thirty-six passengers, and weighs, when loaded, about 14,000 pounds.

The receivership of John O'Brien has been acknowledged by the Broadway & Seventh Avenue railroad company, he in turn signing an agreement to lease to the Seventh Avenue company until the legal questions can be settled. Jacob Sharp and the Twenty-third Street railroad company will follow suit to-morrow. A case will at once be made up to test the constitutionality of the recent act of the legislature annulling the charter of the Broadway road and appointing a receiver, and as soon as this case is settled the leases arranged for will lapse.

Niagara.

The Niagara Falls & Whirlpool Company is now making preparations to build a railway, from a point as near the foot of the inclined railway as possible, to a point just below the whirlpool, a distance of nearly three miles. It is proposed to use electricity as a motive power, the generating dynamo to be driven by turbine. The capital stock of the company, \$100,000, has all been taken up. The road will give a magnificent view of the scenery. Fares will not be over two cents a mile, or 50 cents for the round trip. Mr. B. Fenton and Mr. E. Bennett, of Buffalo, are prominently interested in the road.

* * *

NORTH CAROLINA.

Asheville.

The Asheville Street Railroad Company is being organized.

* * *

OHIO.

Cincinnati.

Cincinnati wants rapid transit by means of an elevated railroad across "the bottoms."

Cleveland.

The East Cleveland and the Brooklyn street railroad companies will build the loop around Bank, Lake and Water streets, which the Superior Street Railroad Company declined to do.

Oberlin.

The Oberlin Street Railroad Company has been incorporated by Alex. McMullen and others. Capital, \$10,000.

Painesville.

The Painesville & Fairport Street Railroad Company, capital stock \$25,000, has been incorporated by S. K. Stage, L. S. Wilson, W. L. Butley and others.

* * *

PENNSYLVANIA.

Allegheny.

The Observatory Hill Passenger Street Railroad Company has been incorporated to run from the corner of Sixth Avenue and Wood Street, Pittsburg, across the river and through Allegheny to the city line. Capital, \$125,000. Directors, Oliver P. Scarfe, William Thaw, Charles L. Caldwell, James B. Scott and Charles C. Scarfe.

Chester.

Within the next month the Chester Street Railway Company, of Chester, Pa., expect to introduce electricity as a propelling power for the cars on their line. The system is known as the Fulian patent, of Belgium, and consists of storage batteries of sufficient force to run a car for thirty-four hours. The batteries will be charged by a stationary engine, which is now being built by Robert Wetheriel & Co. The system is in successful operation at different places in Europe, but this is the first use of it in the United States.

Millersville.

The Millersville Street Railroad Company has been relaying its tracks with T rails, and the Street Committee endeavored to restrain it by an injunction. The city solicitor, however, decided that the charter permitted a rail of this character, and that having allowed the rails to be laid in the first place, and the rails having been lifted under compulsory circumstances, the company can not now be compelled to lay another kind of rail.

Philadelphia.

In view of the liability of accidents in the running of cable cars the Philadelphia Traction Company is introducing a new electrical system on their Market street branch. The plan consists in laying leaden tubes containing telegraph wires, alongside the conduits, and a simple alarm box will be placed in each manhole along the route of the cable cars. This affords instant communication with the engine house at Twentieth street, and when an accident occurs to the cable, necessitating the stoppage of the engine, an alarm can be sent at once to the station, and through an arrangement of signals any information that is needed to meet the emergency can be instantly forwarded.

The grand jury has recommended an elevated railroad.

Pittsburg.

The Pittsburg, Allegheny & Herr's Island Passenger Railroad Company has been granted an ordinance giving it the right of way on certain streets.

The East End & Wilksburg Electric Railroad is approaching completion. It is on the overhead wire system.

The Brownsville Avenue Passenger Railroad is seeking for right of way. The line will be worked by electricity if the Pittsburg, Knoxville & St. Clair railroad experiment is a success; otherwise horses will be used. The new line will connect with the latter road, thereby giving a 5-cent fare between Mt. Washington and the city.

Reading.

The Sixth Street and Pennsylvania Street railroad companies each desire to build on Ninth street, which is a narrow thoroughfare.

The striking street car employees of Pittsburg have started lines of wagons on the Wylie avenue and Oakland tracks, and obtain a fair patronage.

Scranton.

The Scranton Suburban Railway Company has obtained permission from the council to lay down rails and to operate by electricity. The Van Depoele electric manufacturing company is negotiating to furnish its motors.

SOUTH CAROLINA.

Columbia.

The Columbia Street Railroad Company has been incorporated with a capital of \$50,000. President, J. S. Pierson; Vice-President, H. M. Pierson; Treasurer, W. E. Lawton; Secretary, E. Benedict.

TENNESSEE.

Memphis.

The Memphis City Street Railroad Company has filed suits in the circuit court for \$150,000 damages against the new Citizens' Street Railroad Company, and for \$25,000 against David Hadden and the taxing district; R. D. Frayser, president, has also filed suit against J. F. Frank for \$25,000. These suits have grown out of a recent fight between the two companies for the right of way on certain streets, which the district officials granted to the Citizens' company.

Nashville.

The East Nashville Street Railroad Company will spend \$15,000 in erecting stables, car sheds, and a repair shop.

TEXAS.

Jefferson.

It is reported that F. Priest, of Decatur, Ill., will build a street railway here.

Paris.

The Paris Railway Company will extend its present line about two miles as soon as the right of way is granted.

Waco.

The City Railroad Company is negotiating for the Van Depoele electric system to operate its cars and also to furnish power to run all the elevators and printing presses in the city.

WISCONSIN.

LaCrosse.

LaCrosse people are agitating the propriety of allowing a street car company to lay a track up Main street. A public meeting was recently held to discuss the matter.

Foreign Items.

LONDON, ENGLAND.—The first tramway opened in London was that promoted by George Francis Train, about the year 1860; but so much opposition was shown to the undertaking that the cars ceased to run after a few months.

Little further was done toward developing this mode of locomotion until the incorporation of the North Metropolitan Company, in 1869, and this was followed by the registration of the London Tramways Company in the succeeding year. There are at present nine companies with

powers to construct tramways in different parts of the metropolis. The total authorized share capital of these companies amounts to £2,479,500, and the debenture capital to £671,750. The length of the lines is about 105 miles.

This act enables local authorities, or any person, corporation or company, with the consent of the local authorities of the district, to obtain a provisional order from the Board of Trade to construct a tramway, and the Board of Trade have the power to modify or impose conditions before granting the order.

Every provisional order specifies the nature of the traffic for which such tramway is to be used, and the tolls and charges which may be demanded and taken by the promoters, and contains such regulations relative to such traffic and such tolls and charges as the Board of Trade shall deem necessary.

After the order has been granted the Board of Trade has to procure an act of Parliament to have the provisional order confirmed.

The Board of Trade has the power to cancel the powers of the promoters in respect of any tramway, or part of such tramway, if after the opening of the tramway in any district for traffic the working of such tramway is discontinued for three calendar months, provided such discontinuance is not beyond the control of the promoters. But before the tramway is ordered to be removed at the expense of the promoters, the local authority can purchase the powers of the promoters.

The tramway companies have to maintain and keep in good condition and repair so much of any road whereon any tramway belonging to them is laid as lies between the rails of the tramway, and the portion of the road between the tramways, and in every case so much of the road as extends eighteen inches beyond the rails on each side of any tramway.

The local authorities and the company can enter into agreements with respect to keeping in repair the whole or portion of the roadway, and the proportion to be paid by either of them.

Every company has to pay parish rates, the rated value being fixed every five years, and is based on the profits of the undertaking; that is to say, the letting value of the undertaking.

The hours of labor vary from 12 to 13½ hours per day. On the North Metropolitan the hours used formerly to be 14½ per day, but they have recently been reduced to 13½ hours, while the hours on the London tramways have never exceeded 12. This company always allows their men one holiday every ten days. The hours above specified include a rest during the day.

The wages of conductors and drivers range from 4s. 6d. to 6s. per day, according to class. Some of the companies require the men to make a money deposit on entering the service—conductors as much as £5, and drivers £2. Should the men misconduct themselves, and are punished by the imposition of a fine, such fine is deducted from the money deposited. Other companies require no deposit on engaging a servant.

DIVIDENDS PAID.

| Rate pr. ct. pr. annum— 1st half year. | | Rate pr. ct. pr. annum— 2d half year. | | Rate pr. ct. pr. annum— 1st half year. | | Rate pr. ct. pr. annum— 2d half year. | | | | | |
|---|----|--|------|---|----|--|---|----|------|---|----|
| 1874 | 7 | 8 | 1880 | 7 | 8 | 1875 | 8 | 8½ | 1881 | 7 | 9½ |
| 1876 | 8 | 9 | 1882 | 9 | 9½ | 1877 | 8 | 9 | 1883 | 9 | 9½ |
| 1878 | 8½ | 6½ | 1884 | 9 | 9½ | 1879 | 5 | 8 | 1885 | 9 | 9½ |
| 1879 | 5 | 8 | 1886 | 9 | 9½ | | | | | | |

The following are the highest and lowest prices of the £10 shares marked in official list in the years 1884 and 1885:

| | Highest. | Lowest. |
|------|----------|---------|
| 1884 | 19½ | 17½ |
| 1885 | 19½ | 17½ |

TABLE OF COMPARISONS.

| | Half year ending— | |
|---|-------------------|------------|
| | Dec. 84. | Dec. 85. |
| Average number of cars running.. | 204.85 | 227.74 |
| Miles opened..... | 343½ | 33½ |
| Miles run..... | 2,670,781 | 2,950,319 |
| Passengers carried..... | 15,208,750 | 19,606,380 |
| Average receipts from passengers.. | 1.98 | 1.88 |
| Average receipts per mile run..... | 13.49 | 12.50 |
| Percentage of total working expenses as compared with total receipts..... | 74.45 | 72.08 |
| Traffic receipts..... | £150,138 | £158,742 |

The average cost per horse per week for feeding, bedding, etc., after deducting the receipts for manure, is 9s. 1¾d.

THE LONDON TRAMWAYS COMPANY.

Registered December, 1870. Miles worked, 19½.

Capital; Authorized share capital, £430,000 in £10 shares; issued, £350,000 in ordinary shares, £80,000 in 6 per cent. preferred shares.

Debenture issue, £180,000; £136,000 in £100 stock at 5 per cent., £43,900 in bonds at 5 per cent.

Script certificates were issued in 1870, and are entitled to one-half the divisible revenue of the company during each year ended 30th June, after providing for interest, etc., and for payment of a 6 per cent. dividend upon the ordinary and preference capital. They are further entitled, on the sale of the undertaking of the present company, to one-half of any surplus assets which there may be after redeeming the shares of the company at par, and discharging its debts and liabilities. They are either to bearer or registered.

The dividends paid on these certificates are as follows: 1881, 1s. 7d.; 1882, 7s. 10d.; 1883, 14s. 9d.; 1884, 22s. 1d.; 1885, 22s. 2d.; 1886, —. The London Tramways Company give all the employees who have been in their service for two years a bonus every Christmas, ranging up to £10, according to the position they hold. The drivers employed by this company earn an extra 6d. per day when instructing new men to drive. As already stated, the total length of the London tramways amounts to 105 miles, but of this 68¼ miles are worked by three companies. The details of these companies are appended. The value of the ordinary shares of the principal companies on the 18th May was as follows:

| SHARE PAR VALUE. | |
|---|------------|
| £10 North Metropolitan..... | 19½ to 20 |
| 10 London Tramway..... | 17 to 17½ |
| 10 London Tramway, 6 per cent. preferred..... | 14½ to 15 |
| 10 London Tramway scrip certificates..... | 20½ to 21½ |
| 10 London Street..... | 18½ to 19½ |
| 10 South London..... | 4½ to 5 |
| 10 Southwark & Deptford..... | 3½ to 4 |

NORTH METROPOLITAN TRAMWAY COMPANY.
Incorporated in 1869, by Act of Parliament. Miles opened December, 1885, 35¾.

| CAPITAL. | | | |
|-------------|-------------|------------|-------------------------|
| | Authorized. | Created. | Share capital received. |
| Shares..... | £392,000 | £362,000 | £308,866 |
| Loans..... | 248,000 | 146,000 | — |
| Totals..... | £1,240,000 | £1,107,000 | £908,866 |

| CAPITAL RAISED BY DEBENTURES. | |
|-------------------------------|----------|
| Interest 4½ per cent..... | £28,500 |
| Interest 4½ per cent..... | 35,100 |
| Interest 4 per cent..... | 81,400 |
| Total..... | £145,000 |

The dividends paid on the ordinary shares during the last ten years are as follows:

| | 1st half. | 2d half. | 1st half. | 2d half. |
|-----------|-----------|----------|-----------|----------|
| 1877..... | 5 | 7 | 1882..... | 6 8½ |
| 1878..... | 3 | — | 1883..... | 5 9½ |
| 1879..... | — | — | 1884..... | 6 4 |
| 1880..... | — | — | 1885..... | 6½ 10 |
| 1881..... | 5½ | 5½ | | |

Towards the close of 1878 it was found that the dividends had been improperly paid, and that there was really about £100,000 against capital account. There was, therefore, no dividends paid until the second half of 1880.

The following table gives the expenditures and receipts for six months:

| Expenditures. | Per mile run. | Percentage of receipts. | Total. |
|------------------------------------|---------------|-------------------------|----------|
| Horsing expenses..... | 3.75 | 35.63 | £47,621 |
| Traffic expenses..... | 2.74 | 25.67 | 34,846 |
| General expense..... | 27 | 2.55 | 3,604 |
| | 10.56 | 100.00 | £138,693 |
| Per mile run..... | — | — | 11.15 |
| Receipts by passenger traffic..... | — | — | £132,78 |

LONDON STREET.

Incorporated in 1870. Mileage, 9¾.
Capital; Authorized, £239,500 in shares £10; issued, £210,000 fully paid shares, 5,000 shares on which £6 has been paid, £64,500 debentures, £25,000 @ 4½ per cent., £15,000 @ 5 per cent.
Dividends paid: 1880, 4½s. 6d.; 1881, 5s. 6½d.; 1882, 7s. 8d.; 1883, 8s. 8½d.; 1884, 8½s. 10d.; 1885, 8½s. 9d.

TABLE OF COMPARISONS.

| | Dec., 1885. | Dec., 1884. | |
|--|-------------|-------------|----------------|
| Miles run..... | 759,401 | 717,432 | |
| Traffic..... | 42,698 | 44,236 | |
| Earned per mile run..... | 13.49 | 13.86 | |
| Percentage total expenses to receipts..... | 75.72 | 72.23 | |
| Shares..... | Issued. | Dividends. | |
| 10—London Southern..... | £96,000 | 86,240 | No dividend |
| 10—North London, 6 per cent pd..... | 61,960 | 41,880 | No dividend |
| 100—North London..... | 73,620 | 73,620 | No dividend |
| £28,750 North London loan cap..... | 10,000 | | 5 pr. ct. deb. |
| 10—Southwark & Deptford..... | 130,000 | 130,000 | ½ pr. ct. 1884 |
| 10 South London..... | 293,300 | 273,000 | No dividend |
| 10—West Metropolitan..... | 170,000 | 140,430 | |
| £30 Mortgage deb..... | 32,500 | 29,510 | 5 per ct. pdt. |

Dividends: 1882, 3 per cent; 1883, 4 per cent; 1884, 3 per cent. —Bradstreets.

Notes.

THE LACLEDE CAR MANUFACTURING CO, have erected an additional building shop, 110x50 feet, and a new blacksmith shop, 60x40 feet. In the latter they have placed a 700-pound steam hammer, made by Bement, Miles & Co., Philadelphia; also some new forges and other appliances. They are now turning out over a car a day. Among recent ones are the following: 10 summer cars for Chicago Passenger Railway; 10 summer cars for Kansas City Cable Railway; 10 summer cars for Pavana Street Railway Co., Jersey City; 6 summer cars (bobtails) for Lansing, Mich.; 10 close cars for Davenport (Iowa) Street Railway Co.; 4 more for same city; 2 for Emporia, Kans.; 3 for Cedar Rapids, Ia.; 4 for Corrigan Line, Kansas City, etc.

BROWNELL AND WRIGHT recently closed a second order with Kansas City Cable Railway, for grip cars. Certain improvements will be applied to these cars with a view of reducing existing objections.

THE HAZARD WIRE ROPE COMPANY, Wilkesbarre, Pa., have recently completed a rope 24,800 feet in length, all in one piece, for the

Philadelphia Traction Railway Company. It weighed thirty-two tons net.

THE STANDARD HORSE NAIL COMPANY, formerly of Fallston, is rebuilding their factory, which was burned some months ago, at New Brighton. The establishment will cover nearly an acre of ground.

THE LONGEST CABLE EVER MADE.—The John A. Roebling's Sons Co., of Trenton, N. J., the largest manufacturers of wire rope in the world, whose branch office is located at 215 and 217 Lake Street, this city, recently shipped from the works the longest cable ever made, for the St. Louis cable road. The cable is all in one piece, 40,000 feet long, 1 3/4 inches in diameter, and weighs over 100,000 pounds. This immense cable was placed on a reel measuring 10 feet in height and eight feet across. The reel was then loaded on one car, which was especially built to transfer it to its destination. On its arrival in St. Louis it will be loaded upon a wagon having wheels 4 feet high with a 10-inch face, the axles being of 6-inch hollow steel, requiring some 36 horses to draw it from the car to the point required on the line of road.

THE HENRY ELECTRIC RAILWAY.—The Henry Electric Railway Company of Kansas City, of which J. C. Henry, an old telegrapher, well known in the Western country, is electrician, is now engaged in the development of an electric railway system, and have obtained some practical results worthy of notice. The motor, which is now in operation, weighs 4,000 lbs., and the car, when empty of passengers, 6,000 lbs. In an experiment made a few days since it was coupled to a freight car weighing 24,500 lbs., and started without difficulty up a three per cent grade. The car was run with a dozen passengers a distance of half a mile, up a 2 1/2 per cent grade and round a succession of sharp curves, in two minutes, actual running time.

AT THE RUSSELL CAR WHEEL FOUNDRY, Detroit, is to be seen an immense coil of copper

wire, which is wound on a reel seven feet in diameter. The wire is 31-64 of an inch in diameter, and is one continuous piece, 11,600 feet in length. It cost \$1,100. It is to be used on the Dix-avenue Electric Railway.

NEW YORK, July 1st, 1886.

I beg to announce that I have purchased the interest of the late B. A. Clooney in the firm of Andrews & Clooney, and will hereafter conduct the business of the Globe Iron and Spring Works under my own name.

With a competent staff of assistants in all departments, I feel warranted in assuring all of the late firm's friends and customers that their interests will be carefully studied if entrusted to me. To Railroad officers and others I can say, that profiting by experiences in the past, all orders will be executed with promptness, in a workmanlike manner, and at the lowest possible margin of profit to myself.

Soliciting your esteemed orders, I remain,

Very truly yours, FRANK H. ANDREWS.

THE ARBEL WHEELS, illustrated in this issue, is being introduced in this country by Charles G. Eckstein & Co., of New York. The Cockerill Company, associated with Mr. Arbel, have at their extensive works in Belgium a special department for the manufacture of these wheels. The company employs 12,000 workmen.

THE SAFETY ELECTRIC POWER COMPANY, which has purchased the rights from the Daft Co., for a large territory, has opened offices at 41 and 43 Wall street, New York, and is ready to equip street railways of all kinds. The company will furnish estimates and particulars on application. The officers are John Murray Mitchell, President; William R. Crowell, Vice-President, and Henry S. Iselin, Secretary and Manager.

THE BROOKLYN RAILWAY SUPPLY COMPANY are now constructing two sizes of what is known as the Allyn Sweeper. One of the larger size is for the Nostrand-avenue line.

J. G. BRILL & CO.,

PHILADELPHIA,

Builders of

Railway and Tramway Cars.

GOLD MEDAL
For Best Closed Car
AT
CHICAGO EXHIBITION
Of 1883.



GOLD MEDAL
For Best Open Car
AT
NEW ORLEANS EXHIBITION
Of 1885.

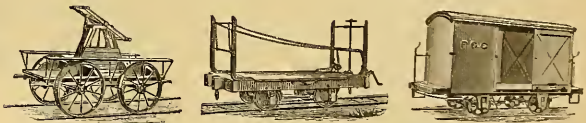

WANTED; FOR SALE; EXCHANGE.

This department has been established as a medium of exchange and bureau of general information, for the convenience of those connected with street railway industries. Street Railway Companies wishing to dispose of or buy cars, appliances or stock, or having contracts to let; persons having vacancies to fill, or wishing situations, etc.; etc., are invited to use this department without charge, being requested only to notify us when the object desired has been accomplished.

WANTED: POSITION.—By a practical Street Railroad man of 10 years experience in the management of employees and office details. Also several years experience in handling money and tickets. Strictly temperate and can furnish best of references from past and present Street Railroad Officers and others. Age 43. Address, S. LAMBERT, 177 Bank st., Cincinnati, Ohio.

WANTED.—A Street Railway, in Nevada, Missouri. A liberal franchise will be given. For particulars, address "Nevada," care of this office.

FOR SALE.—Street Railroad connecting two live manufacturing towns. New road. Population 22,000. Good business. We have exclusive franchise. Address, HORSE RAILROAD, care STREET RAILWAY GAZETTE.

WANTED.—A thoroughly competent Foreman, experienced in the details of street railway construction. Address "A," care STREET RAILWAY GAZETTE, giving experience, references and salary expected.

FOR SALE.—A number of second-hand "bob-tail" cars. Description and price will be furnished on application to "CLEVELAND," care STREET RAILWAY GAZETTE.

CHAS. H. MITCHELL,

Attorney and Counsellor at Law.

Practises in all the Courts. Railway Litigation a Specialty. Special attention to Patent Cases and Collections. Prompt attention to Correspondence outside the City. Refers by permission to the THE ENGINEERS CO., THE WRIGHT, MONROE CO., and others.

161 La Salle Street, - - CHICAGO, ILL.

Chicago Malleable Iron Co.,

MANUFACTURER OF REFINED

Malleable Iron Castings,

Western Avenue & 26th Street,

CHICAGO.

✽ Street Railway Work to Pattern. ✽

Barnum & Richardson Manf'g. Co.,

64 South Jefferson Street, CHICAGO.

CHILLED STREET CAR WHEELS

FROM PURE SALISBURY IRON.

Curves, Frogs, Switches, Crossings, Etc.

To Any Pattern.

Light and Heavy CASTINGS for all purposes.

W. H. BARNUM, ALBERT ALLING, WM. E. BEST,
Pres., Lime Rock, Conn. Gen. Mgr. & Treas., Chicago. Sec'y, Chicago.

O. W. MEYSENBERG & CO.,

WESTERN AGENTS

Johnson Steel Street Rail Co.

JOHNSON STEEL GIRDER RAIL

AND STEEL ROLLED CURVES,

Switches and Frogs, also Metallic Ties,

85 Dearborn Street, Adams Express Bldg., CHICAGO.

ST. LOUIS, 204 North 3d Street, Gay Building.

FOREMAN WANTED

FOR AN EXTENSIVE STREET CAR BUILDING ESTABLISHMENT. A man of experience, fully competent to take charge of the entire mechanical detail and who can command the highest testimonials as to ability and character can learn of a first class opening by addressing WESTERN, Care STREET RAILWAY GAZETTE, 43 Lakeside Building, Chicago.

Anti-Fever Medicine.

A SAFE and CERTAIN

Remedy for all Diseases of an inflammatory character to

Horses & Cattle.



Send for Pamphlet containing

Testimonials.

Samples FREE upon application and Mentioning this Paper.

Dr. William Somerville & Sons,

127 ERIE STREET, BUFFALO, N. Y.

Josephine D. Smith,

350 and 352 PEARL ST., NEW YORK.

Tin and Brass Box Lamps,
CHIMNEYS, BURNERS, ETC.

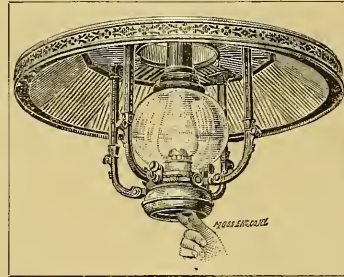

METAL CAR TRIMMINGS REFINISHED.
BRASS FINISHING.

Manufacturer of Railroad Car Center Lamps and Reflectors.

HORSE and MAN.

Their Mutual Dependence and Duties.

By the Rev. J. G. Wood, M. A.

Author of "Homes without Hands," etc., with illustrations. 8vo. extra cloth, \$2.50.

"Certainly he has written one of the most valuable books about the horse and his proper care that have ever been issued from the press, for it makes very explicit statements concerning conditions that most books of its class fail to treat with anything approaching fulness, while it antagonizes in the most direct and positive manner common practices of the stableman and blacksmith. Some idea of the scope and method of Mr. Wood's book and of his manner of handling his subject may be gained when we say that eleven of his seventeen chapters are devoted to the foot of the horse, its construction, its proper usage, and so on. Mr. Wood not only finds plenty to say about horses' feet and their treatment, but says it very entertainingly; indeed, the book is a remarkable one for its entertaining qualities. It is not only full of information and important suggestions, but it is most charmingly written."—Philadelphia Evening Telegraph.

For sale by all Booksellers, or will be sent by mail, postage prepaid, on receipt of the price by

J. B. LIPPINCOTT CO., Publishers,

715 and 717 Market St., Philadelphia.

The Street Railway Gazette.

VOL. I.

CHICAGO

AUGUST, 1886.

NEW YORK

No. 8

Charles Hathaway,

the subject of this sketch, was born in Grafton, Mass. He is of English descent. His ancestors emigrated to this country from the county of Staffordshire, England, in the latter part of the seventeenth century, and were of the same family as Anne Hathaway, who was married to the immortal Bard of Avon. His grandfather, both on his father's and mother's side, did good service in the revolutionary war, having fought at Bennington and many other battles during those dark days.

The first few years of his life were spent on his father's farm, but such an existence not being congenial to his tastes, he turned his attention to mechanical and engineering pursuits. At the age of twenty-two he started in business as a civil engineer and contractor in the New England States, and met with success in his many business operations.

Wider scope for his abilities presenting, he located, and opened an office in Philadelphia in 1851, his specialty being street railroad construction. Here his success was assured, and we find him connected with the building and operating of most of the roads in that city. During the following years, and down to 1860, his street railroad contracts were extensive, and there are few cities in this country where a street railroad exists, but what the subject of this sketch has been connected with, either in its construction or its operation.

In 1860, he contracted with some English capitalists to build three street railroads in London. Here he met with some experience in English courts of justice. Street railroading at that time was an entirely new method of locomotion in England, and a great departure from the old-fashioned London cab. As there were no street railroads in London, there were of course no laws governing them or their construction. The right of way being secured, Mr. Hathaway, with his usual energy, commenced tearing up the Queen's highway as a preliminary to laying the rails. But he very soon found that by such acts he was offending the dignity of the municipal authorities of that great city, and the fact was gently made known to him by an arrest. Bail was easily procured, his offense not being intensely criminal.

After being under arrest for about a year, he was cited to appear before Judge Blackburn, who thought the majesty of the law would be amply satisfied if he paid a fine of one shilling (English), which he quickly did, and stepped from the court-room a free man. In the meantime he pushed ahead with his contracts to completion, and, in spite of arrests, "got there just the same." There were at least 25,000 people gathered together to see the first car start, and the greatest satisfaction was evinced at the convenience of the new public conveyance.

Mr. Hathaway also built several other street railroads during the time he was in England, one being at Birkenhead, one at Darlington, and one running from Hawley to Berslam. The latter place was visited with peculiar interest by Mr. Hathaway, from the fact of its being the home of his ancestors. After the completion of his English contracts, in 1863, he returned to Philadelphia.

In 1873, Mr. Hathaway removed from Philadelphia to Cleveland, O., and opened an office in the Case Building, which he occupies at the present time.

For some years he has had associated with him in business, as street railroad contractors and builders, Mr. Frank De H. Robison, his son-in-law, under the well-known firm name of Hathaway & Robison. Under their supervision have been built street railroads in Philadelphia, Rochester, Cincinnati, Cleveland, Detroit and many other cities in the United States too numerous to mention, and in London, Hamilton, Belleville, Kingston and

many other Canadian cities.

Mr. Hathaway has been connected with between ninety and one hundred street railroads, either as builder or part owner, during his business life. The Superior Street Railroad, of Cleveland, was built and is partly owned by him. He was president of the road for a number of years, but finally resigned his position to take charge of the St. Clair Street Railroad, of Cleveland, as its president, he being the principal owner of same.

Mr. Hathaway has been the inventor of many useful appliances used in street railroading, of which his transfer table for car houses is too well known to require further mention.



Charles Hathaway

He is not averse to manly sports, and, when business will permit, may be often found, in company with some kindred spirit, in some out-of-the-way swamp, with his rod and gun, either angling, hunting ducks or any other game that he might happen to come across, the chances for a prolonged life for which are very few should any fish touch his hook or game come within range of his trusty gun.

Mr. Hathaway, once known, can never be forgotten. His genial disposition makes his company always desirable, and, with it, he possesses an inexhaustible fund of quiet humor, at all times attractive and entertaining.

Improved Sash Holder.

USEFUL DEVICES FOR CAR WINDOWS.

Who of us has not at some time, when traveling, been annoyed with car windows? The weather is warm; we want fresh air, and endeavor to raise the nearest window, but it positively and firmly objects to being elevated. In winter we guard against draughts, dust and smoke, but the window nearest to us has been left up, and refuses to come down. The aid of a powerful conductor is frequently necessary to operate the catches and stops the little holding devices, their name is legion—which are used for a purpose they hesitate to fulfill.

We give illustrations of two new devices that are applicable to car windows and steamboat windows, in short, to any window which has to be frequently opened and closed.

Fig. 1 shows a sectional view of a sash-holder. The action of the spring forces the holder against the frame constantly, and thus the sash is held by friction at any point of opening, with ease, while at the same time the holders serve the purpose of most efficient anti-rattlers. Two of these holders set in each side of a sash, giving an even pressure, will hold an ordinary window at any desired height. It therefore does away with the use of cords and weights. In car windows this little simple device, easily attached, becomes specially effective, holding the window at any point, and is easily adjusted to suit the wishes of the traveler. The material of which the holder is composed is a compound claimed to be almost as hard as iron, yet of a rubber character that will not imbed in the frame or mar the paint.

Fig. 2 is another device designed to be a sash-holder and anti-rattler. It is composed of the same material as the device just explained, and revolves easily about the screw by which it is held in its place. It is set on the frame pressing against the edge of the window sash, and being of a flexible or rubber nature, it gives a constant pressure against the sash, thus preventing all rattling, and by constantly pressing the sash back to the window frame performs the service of a weather-strip. It readily revolves as the sash moves up or down, thus avoiding friction. The sash-holder and anti-rattler are applicable to other purposes.

They are two of the numerous devices which come into very extensive use through their utility, inexpensiveness, and the convenience they give when applied.

FIG. 2.

THE system of compressed paper rails and railway carriage wheels is getting more and more into favor. A company in the environs of St. Petersburg has a large factory devoted to this special manufacture, authorized by the Russian Minister of Finance.

CHICAGO society is struggling with the question as to whether a man shall take his hat off or not in an elevator in the presence of ladies. There ought to be no objection. A man may take his hat off in a street-car if he likes; but if he is, bald ladies will prefer to have him keep it on.

Construction, Equipment and Maintenance of American Street Railways.

BY AUGUSTINE W. WRIGHT.

(Continued from page 136.)

CHAPTER III.

TRACK CLEANING.

This is a question that interests Street Railways, more especially in the Northern States where excessive falls of snow interrupt the traffic and require the greatest effort upon the part of superintendent and employés to keep the road open, to accommodate the multitudes; a greater number seeking transportation at such times, in inverse ratio to the ease with which they can be carried. The subject will be considered under the following heads:

- 1st. Attachments to individual cars.
- 2nd. Snow Ploughs.
- 3d. Sweepers.

ATTACHMENTS TO INDIVIDUAL CARS.

These consist of scrapers or brooms. The scrapers are quite extensively used. Figure No. 35 shows a scraper manufactured by H. H. Littell of Louisville, Ky. It is said to be forged from the best steel and wrought iron without castings, which might break, and is easily attached to, or removed from, a street car, without cutting or disfiguring the dash. It possesses the great advantages over other scrapers of being manipulated by the driver's foot, without requiring him to remove his hand from the brake handle.

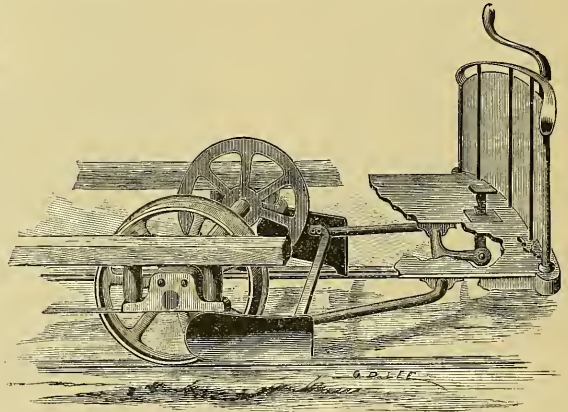

Fig. 35.

The figure shows a portion of a car to which the scraper has been attached. Hangers are bolted to the sill, carrying a transverse rocking shaft, to each end of which a scraper is securely fastened, and a cross brace inserted. Its center is extended forward, with a recess at the end in which a lever works, projecting above the car platform and worked by the driver's foot as above stated. A ratchet upon the side holds the scraper up out of the way when not in use. To prevent its being jarred over, a key is provided, chained to the dashboard, so that it may not be lost. When this key is out, the driver can apply the scrapers instantly, to remove an obstruction upon the track. A. Day, of Detroit also manufactures a scraper. It is worked by the driver with one hand, and has been extensively applied, over two thousand pairs having been in use in 1885.

Scrapers are used, not only to remove light snow, but also mud, small stones or obstructions upon the rails. In a macadan paving, the loose stones are frequently thrown upon the rail by passing vehicles and must be removed, or the passengers are jolted, the car racked and the horse strained in an attempt to pass over it.

The advantages in the use of scrapers are obvious.

The disadvantages are—1st. Putting increased resistance upon the animal drawing the car. This, it is claimed is more than offset by the lessened power required upon the cleaned rail. 2nd. Throwing up a ridge, adjacent to each rail along its outside line. Many think that in winter weather, passengers alighting from the car are liable to slip and fall upon these ridges, resulting in accidents. A prominent superintendent who had carried probably over a hun-

lowered to the rail, or raised clear from it, as may be desired, by levers on top of the floor, as shown in drawing.

Wings are provided, from three to eight feet in length. They are easily attached by means of a hook at one end, and held in position by an iron rod 36 inches long by 1½ inches in diameter, extending to the other scraper, making a flexible joint vertically, so they can be raised to pass over any obstruction by a wooden pole, also shown in drawing.

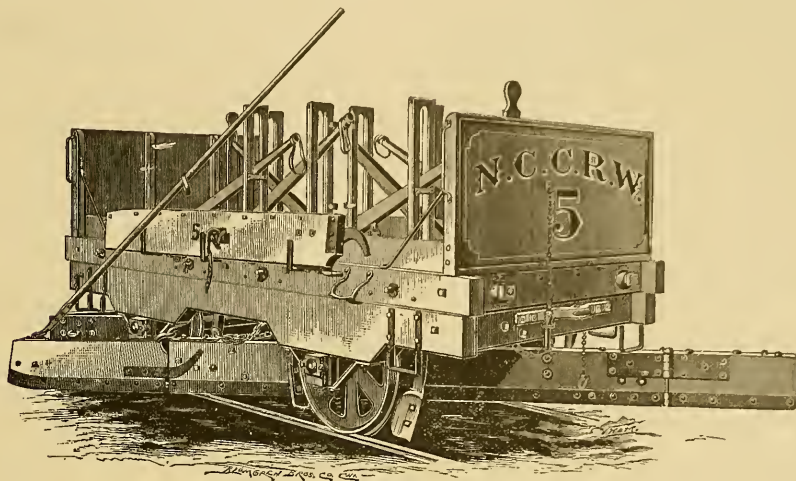

Fig. 36.

dred million passengers, upon cars equipped with scrapers, told me he had yet to hear of an accident attributable to this cause.

SNOW PLOUGHS.

Snow-ploughs are built of various shapes and different designs, according to the locality where they are to be used and the consequent amount of snow to be removed.

Day, of Detroit, makes one, mounted upon a wagon so that it can be used along the Street Railroad track, or entirely outside. In excessive snow falls, this is an advantage, for at such times, the snow having been thrown up in ridges adjacent to the tracks, vehicles cannot either turn out or proceed along the street except upon the track, thus impeding street car travel. With such a snow plough as Day's, however, the banks on each side can be leveled outside of the tracks, when traffic will soon condense them and thus afford a passageway, removed from the rails.

Figure No. 36 shows a type of snow-plough used by the North Chicago City Ry. The frame is 6 feet 1 inch wide and 12 feet, 4 inches long of seasoned white oak and thoroughly braced. The floor is 38 inches above the track. Sills are 8 inches deep by 4 inches wide. The wooden dash at each end is 31 inches high and 73 inches wide, wheels are 30 inches in diameter.

It has eight knives of plough steel, one in front of each wheel, the plough running with either end front. Their bottoms are made to correspond in shape, to the rail head, and each is raised or lowered by a lever, as shown in drawing.

The plough proper, or scraper, is made of white oak 12 inches x 2½ inches x 10 feet 4 inches long, shod with iron. There are two of these scrapers, inclined at an angle of 18 inches in 24 with the line of track, passing on each side of alternate wheels. They are braced one against the other by two oak pieces 10 inches by 2½ inches wide, held together with ¾ round iron rods. At the ends, additional iron braces are provided, as shown in drawing.

This frame is hung at the center of its length near each wheel-axle, by a toggle joint, so that either scraper can be

The length of wing selected to use from the several provided, is regulated by the fall of snow and the distance it is desired to throw the snow.

Four iron ladder steps, one at each corner, are provided to mount the platform. Either end runs foremost. Four horses, a driver and two men are required in operating.

Street Railway Patents.

Cable grip, No. 344,598—Edward Samuel and Victor Angerer, Philadelphia, Pa.

Cable railway, No. 343,981—Richard F. Bridewell, San Francisco, Cal.

Car brake and starter, No. 344,784—John S. Lubs, New York, N. Y.

Car seat, Nos. 344,112 and 344,113—John C. Kafer, Washington, D. C.

Grip cable railway, No. 344,533—Henry M. Lane, Norwood, O.

Gripping mechanism for cable railway cars, No. 344,057—Renaldo Solano, Brooklyn, N. Y.

Street indicator for street railway cars, No. 344,047—H. I. Jeffers, Manchester, Ia.

OWNERS of horses should give personal attention to be sure that their grooms, coachmen and drivers properly wash and cool their teams after work. This should be done at all times, but particular attention is required during the warm weather. Animals will sleep and feed better for the care, and do better work the next day. Mercy towards all dumb brutes carries a blessing, but none are more immediately rewarded for kindness than the owners of stock. Horses and mules work the better, and it is known that cows give more milk when treated kindly.

CHIEF ENGINEER BROWN, of the Pennsylvania Railroad, has decided against the use of iron ties, which cost from \$3 to \$4 each, while good white oak ties can be procured for \$1 each.

The Kansas City Electric Street Railway.

Messrs. Editors Street Railway Gazette:

So much has recently appeared in the press concerning the system of electric railways, devised and patented by Mr. John C. Henry, of Kansas City, that it is believed that a brief account of the condition and prospects of this system will be interesting to the public, and especially to those engaged in the management of street railways.

Mr. Henry's system has been adopted by the Kansas City Electric Railway Company upon their line of street railway along East Fifth street, running from the Market square to Lydia avenue. This line is a mile in length, and has a difficult curve and several very heavy grades—in one case as heavy as six per cent.

The plant will consist of four motor cars (which in this system carry passengers also, in the same manner as grip cars on cable railways) and such passenger cars as will be necessary for the convenience of the public. It is expected to draw one or more passenger cars with each motor car. A double track has been laid on this line, and the engine house is being built and all the necessary machinery, engines, and electrical appliances have been ordered. It is expected that this line will be in operation within three weeks from the present date, July 23d.

The choice of this system of electric railway by the Kansas City company has been made after a careful examination of the systems in use in other cities; and it is quite a compliment to Mr. Henry, that the invention of a western man should have received precedence over the inventions of such eminent electricians as Messrs. Daft, Edison, Van Depoele and others.

A brief description of Mr. Henry's system is as follows:

It must be premised that Mr. Henry makes no claim at this time to any invention of machines for the generation or utilizing of electro-motive force in the forms of dynamos or motors. These machines, in a single decade of progress, have reached a point much nearer perfection than that attained by the steam engine during a century of inventions, and are now commercial products with well defined characteristics and prices. The merest tyro in electrical science knows that the different purposes to which electricity is applied, such as illuminating, motive power, electro plating, smelting ores, electrolysis, etc., require different qualities of current. Even the two methods of electric lighting now in use, the arc and incandescence, require currents so different that neither can be used with the current needed for the other. Hence all dynamos must be manufactured with special reference to the purpose for which they are intended. For the purposes of electric locomotion, however, each system thus far invented has adopted a different current; some use high tension, others quantity currents in varying relations with each other. Mr. Henry uses a moderately high tension current. But whatever the current required, the armature of the dynamo, or generating machine, must be revolved at a uniform and very high rate of speed, amounting, in the most efficient machines, to from 800 to 1,000 revolutions per minute. Of course, this speed is duplicated in the armature of the motor, when the current is used for locomotion, and makes it impossible to gear the motor shaft directly to the driving shaft of the car or vehicle. If some ingenious inventor can discover a means of generating magneto-electricity by means of a low speed armature, his fortune is made; but, in the present state of advancement on the subject we are compelled to take the machines at hand; and Mr. Henry's claim is, that he has succeeded in reducing the almost inconceivably swift revolutions of the motor shaft to the comparatively slow motion required for the driving shaft of the car with less loss of power and efficiency than other systems. But the problem requires more than a mere reduction of speed. Many other systems have accomplished this. It is required that, while the armature of the motor revolves at a uniform rate of speed, the rate of speed conveyed to the driving shaft shall be variable through a wide range. The suggestion of a well-known mechanical principle will explain this necessity. Any one visiting an iron foundry will find the lathes turning at various rates of speed. When it is desired

to do light work, the lathe runs very rapidly; but where heavy work is required the motion is slow and ponderous. This is but an instance of the rule that speed and power are intra-convertible; if great power is required from a given limited source we must dispense with great speed; if great speed is required we must dispense with great power. It is this principle that makes Mr. Henry's application of a variable speed regulator to street-car propulsion peculiarly valuable. But the triumph over this obstacle (which others had been unable to overcome) did not, according to Mr. Henry's ideas, complete his system of electric locomotion. He observed that all perfect machines dispensed almost entirely with the interposition of human discretion and skill in the performance of their functions; he observed, moreover, that any heavy weight, while being raised up an inclined plane, stores up enough power, in the form of gravity, to raise lighter bodies up the same plane on its descent. It is to his credit that he is the first inventor to apply, with any attempt at thoroughness, these observations to the perfection of a system of electric locomotion. After much trouble, he succeeded in inventing a series of apparatuses which, actuated by the current entering the car, reduced the labors of the motineer or driver to operating the lever of the speed regulator. This invention, together with another device, for connecting the motor up as a dynamo, also enabled cars descending grades to help others ascending. The system thus completed may be said to consist of three parts: (1) The means provided for conducting the current of electricity from the dynamo to the car; (2) the automatic devices interposed between the contract carriage and the motor; (3) the transfer of power from the motor to the driving shaft of the car. The conductors used by Mr. Henry are (preferably) copper wires three-tenths of an inch in thickness. Two of these wires are used for each track, one to carry the electricity from the dynamo to the motor, the other to return the current back to the dynamo. The wires are supported from insulators directly over the track, the insulators being fastened to guy-wires stretched across the street from poles placed at opposite curbs. This is not the place to discuss the propriety of placing poles and wires in city streets, but it may be observed that the objections to telephone, telegraph and electric light wires are not applicable to the wires of this system, as they are strung along the center of the street and offer no obstructions to firemen; nor do they constitute a nuisance to those who occupy buildings near them. The wires are supported at the insulating points by brass ears which surround the wires and are screwed fast to the insulators. These ears increase the size of the conductor at the point slightly, but in practice this offers no obstruction to the passage of the contact carriage, which I will now describe. In almost every other system in existence the contact carriage is simply a metal brush which slides along the conductor, or a wheel which presses on the conductor from above, or below, and thus gathers up the electricity. There are several very grave objections to this mode. In the first place, it is difficult to secure an even, uniform pressure of the brush on the conductor, and hence the current coming to the motor constantly varies in strength. We need no engineer to tell us what the effect of such variation is. Another objection is the constant sparking of the brush; that is, the electricity in passing from the conductors to the brush, or from the brush to the conductors, finds places where the contact is not perfect and leaps across, forming a miniature flash of lightning. Where this occurs there is always deterioration of brush and conductor which calls for constant scrutiny to keep them in order. Mr. Henry's device consists of a small carriage with four, or more, grooved wheels embracing each wire laterally. This carriage is really a double carriage, as one side of it is used to conduct the current to the motor and the other to return it to the negative wire. The two sides are insulated from each other by wooden connections. From the contact carriage two wires depend into the car, and are attached to the helices of the motor. The wheels of the carriage are held in place on the wires by stout springs, which make the contact perfect; so perfect, that in wires and carriage used on Mr.

Henry's experimental lines for over a year there has been no deterioration at all from sparking. In its passage to the motor from the contact carriage, the current encounters a series of automatic devices which permit only just enough current to enter as is needed to propel the car. If the car is going down grade with sufficient momentum to dispense with the motor the current is all shut off, and a device connects the motor up as a dynamo in which the momentum of the car generates a current of electricity which is sent out on the wire to reinforce the power of the dynamo at the station. Thus the boast of cable inventors that their system is the only one where cars descending help other cars ascending a grade is no longer true.

Mr. Henry's device for regulating the speed of the car is a system of spur gearing, of progressive sizes, with sliding shaft operated by a lever which admits of instant shifting, while the car is in motion, to any desired rate of speed. If the car is on a level track the speed can be set at eight, ten, twenty, thirty or more miles per hour; but when heavy grades must be climbed it may become necessary to exchange speed for power, and, in that case, the speed is fixed to suit the grade—perhaps at four, five, or six miles per hour. The reciprocal action of the cogs on the driving shaft with the cogs on the gearing is secured by resting the angle iron frame, upon which motor and gearing ride, in such a way that its motion is in one direction only, no matter what the vibration of the car may be. To attain this, Mr. Henry's system rests one end of the angle-iron on the axle and the other on the frame of the car, both ends being strongly secured and held, so that the only motion of the frame is up and down. Now as the cogs on the gearing can alter their position, as regards the cogs of the driving shaft, in only one direction, and can only do so in that direction along an infinitesimal segment of a circle, it is obvious their reciprocal action will always remain practically perfect.

I have not attempted in this sketch to enter into detailed, or technical, description of Mr. Henry's system, but have sought to explain it in a popular and concise way so that all can understand it. It only remains to say on this topic that there are many important minutæ left untouched, including an underground conduit system and a method of utilizing old iron rails and cables for underground conductors, etc.

I can not do better in closing this paper than to quote the words of Mr. A. F. Upton in a recent address before the National Electric Light Association: "The advantages of electricity over steam for railway purposes are many and great. In the first place the bulky locomotive is done away with, as the electro-motor can be placed either under the car or on trucks by itself; in either case great weight and room being saved. The machinery for converting the coal into the power, or rather extracting the power from the coal, is not portable but stationary, and can be placed in the most convenient spot. For transmitting the power in many cases no difficulty has been experienced in using one middle rail as the conductor. Sometimes, it has been found that the dirt sticking to the rails and the wheels formed a sort of crust, so insulating as to prevent adequate communication. From all the information I can gain on this subject it is my opinion that the most practical way will be to use wires on poles. The poles can also be made available for stringing electric wires for both incandescent and arc lighting. The future of this system is filled with possibilities. It will eventually become the motive power of the present horse railroads. In a few years elevated electric railroads will be as plenty as steam railroads are now, and in time it will supersede the present system of running locomotives on all railroads. And why not? It is simply a question of cost of making power. It is acknowledged by every practical engineer that the present system of making steam in locomotive boilers is expensive as well as wasteful. The evaporation of pounds of water to each pound of coal consumed to make steam in locomotive boilers does not average over three and one-half pounds of water, using the best grades of bituminous coal; while with stationary boilers set to burn coal screenings for fuel, an evaporation of nine pounds of water to one pound of fuel is made, and the reduction in cost of fuel is from one-third to one-half. It is only a ques-

tion of time when all the different electric lighting stations in this country will use their engines in the daytime to make power to be sold for manufacturing purposes, the same as they sell power in the form of electric lights now. They can also furnish power to run electric railways, elevated or surface. The economy of this system over the cost of running horses, as used now, will be over fifty per cent. As to speed, it is impossible to give the limit which can be reached on electric railways, because those so far constructed are on streets or in localities where very rapid transit is not possible or desirable. On the Berlin railway, opened in 1881, the greatest speed reached was eighteen miles per hour. More was possible, but the police authorities refused to permit more than nine miles per hour. Up to August, 1882, [and it may be said up to the present time] there had been no breakdown on this road. On the Siemen's railway at the Paris exhibition of September, 1881, a distance of over 1,600 feet was traversed in a minute, which is at the rate of nearly twenty miles per hour. There is every probability that electric locomotives can be run faster than any steam locomotive now used. About ten miles per hour is the average speed that a car can be run on an electrical street railway, but I think it is possible to run at the rate of 100 miles in an hour. In the near future, on elevated railways, this will no doubt be accomplished. I believe that the time will come when cars will be run by electricity between Boston and New York in about two hours' time, where it now requires six hours by steam railroads."

To these remarks it may be added that, in any comparison of the cost of plants and expenses of operating street railroads, the advantage is with the electrical system. Of course, there are some of these more expensive than others, and I am convinced, from a thorough examination of the subject, that, of all at present in operation, the system invented by Mr. Henry is the most economical as well as the most efficient. The cost of constructing a first-class double-track cable railway can not be brought below \$150,000 per mile, while the running expenses and the consequent outlays for replacing cables, sheaves, etc., make it the most expensive form of street railway to operate. A dummy line equipped in the best style will cost from fifty to seventy-five thousand dollars per mile—according to the number of dummies used—and the cost of fuel on such a line, as shown by the figures given above, is from one hundred and fifty to three hundred per cent. greater than where stationary engines are used. The cost of equipping and operating a horse railway is about thirty thousand dollars per mile, while the operating expenses are at least fifty per cent. more than under an electrical system. It is claimed that the Henry system of electric railways can be placed on any street car track, where the track is already laid, for from ten to twelve thousand dollars per mile. And with such an equipment and low operating expenses, this system promises to return greater efficiency, regularity and public comfort and convenience than any other system now in use. It emits no noise, or smoke, or gases, and its conductors, being placed over the middle of the street, do not endanger the lives of those using the street or interfere with the duties of firemen and others by obstructing access to buildings.

WARREN WATSON.

"I TELL you, Bromley, fortunes are made in little things. The return ball is an instance of that. Now here's a man invented a horseshoe, readily strapped on with a buckle."

"Yes, Darring, I got a set of them for my mare. Do you know, she can put them on and take them off herself?"

"No!"

"It's a fact. I heard a racket in her stall yesterday, and peeped in. She had taken off her shoes and was just putting on slippers."

If each American railroad company started a scientific department of its own, in which all technical questions belonging to the extended field which railroads have to embrace could find such perfect solution as it is only possible to obtain by the coöperation of scientific knowledge and practical executive skill, a far greater degree of efficiency and economy might be attained.—*Railway Review.*

Cable Railway Propulsion.

BY W. W. HANSCOM, M.E., M. TECH. SOC.

[Copyright by the Author.]

(Continued.)

That the cable may be spared abrasion in moving through the jaws of the grip when the dummy is standing still and the cable passing along, four rolls, having their circumferences grooved to suit the rope, are so arranged that they are a little in advance of the jaws and support the cable before the jaws come in contact with it. A spring is placed behind these rolls, so that they may yield when the jaws are brought together to grip the cable.

The cars are of such size that they will seat fourteen persons, and weigh, unloaded, 2,800 pounds each; the dummies weigh 2,850 pounds each, and have seats upon them for sixteen passengers.

As this road was extended after having been in operation about five years, some changes were made in the construction of the tube and in the cast-iron frame, which was extended laterally, so that it now comes under and supports the rails, and has its base extending the same distance, the web being perforated in the center to the shape of the tube, and also openings between the central, and each side-ribs or flanges being formed all around the openings and the outside of the frame. The tube in the extension is formed of concrete, and as it passes through the openings of the frame it forms a monolithic structure the length of the road to which this mode of construction is applied. The slot is formed by channel irons six inches deep, with two-inch angles top and bottom bolted to the casting, and wood carlines are placed from frame to frame only to support the wood plank which forms the street surface between the rails.

I have thus stated generally the most important features of construction in the Clay Street Hill road, and in referring to the other roads will only allude to the more prominent conditions which involve changes in construction and operation, when they vary from the Clay Street Road. The next road to be operated by cable in this city was the Sutter Street Road, which had been operated by horses, but in 1876 was converted to a cable road. The more prominent change was in the construction of the gripping apparatus, which was arranged so that the jaws which take and hold the cable are moved vertically, so that the cable enters between the jaws of the grip from the side instead of from the bottom, as does the one in use by the Clay Street Road. These are distinguished from each other by the direction from which the cable enters the jaws. That of the Clay Street entering from the bottom is called a "bottom grip," and that of the Sutter Street entering from the side is called a "side grip."

The side-grip is so constructed that it cannot be lowered like the Clay Street grip to take the cable, but has a

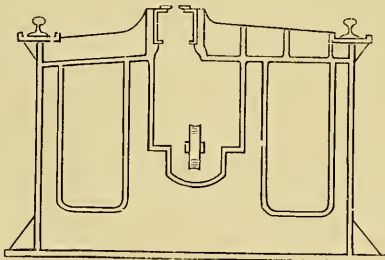

FIG. 6.

fixed position when placed on the dummy. As the cable will normally lie directly under the jaws of the grip, either the jaws or the cable must be moved sidewise to allow the cable to be brought up to a height which will allow it to enter the open jaws of the grip. As the readiest means of accomplishing the raising of the cable, a sheave is so placed in the tube that the cable will be raised by it to a

height corresponding to the opening of the jaws; but as without lateral movement of the grip it would strike the sheave, the rails and iron forming the slot are deflected, to carry the dummy and with it the grip to one side sufficiently to pass the sheave, and immediately again the track and slot is deflected into its normal direction, thereby bringing the opening of the jaws over the cable before the cable has sagged or dropped sufficiently to prevent it entering the grip.

In the later constructions of the grip, the points at which it is supported on the car are so arranged that it may vibrate from this point laterally, so that the dummy need not be carried bodily sidewise; therefore only the irons forming the slot are deflected. Wherever it is desired to let the rope out of the grip and take it up again the road is formed in this way, these points having been determined upon in advance.

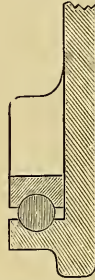

FIG. 7.

The plan for switching from one track to the other is different from that in use on Clay street. A tube is constructed leading across from one main tube to the other, and following the curve of the rails which transfer the cars and dummy from one main track to the other, the tubes are joined at the point of intersection. The slots of the tubes join similarly, and a tongue is placed at the junction of the two slots to cover the large opening into the tube at this point, and is also used to direct the shank of the grip into the proper slot.

These dummies and cars are not turned round in the operation of switching, as by the method by turntables on Clay street, so that the cable lies on the same side of the tube, or rather the same side of the slot, in both of the main tubes. Of course, in switching or passing from one main tube to the other the rope is dropped from the grip, and as the dummy passes on to the main line the cable is brought up so that the grip may run on to it, as before described. At points where the car and dummy are transferred through a switch it is necessary to have a falling grade, so that, after dropping the cable, gravity may assist in carrying the dummy through the switch and on to the other main line. Where the street is officially level, latitude has been allowed the cable companies to make a grade to suit their desires.

At the point where the cables enter and leave the engine house there is an intervening space between the two large sheaves which deflect the cable from and into the tube and engine-house. The cable is dropped from the grip just before reaching these sheaves, and a slight grade is given the street in the direction in which the car is moving, so

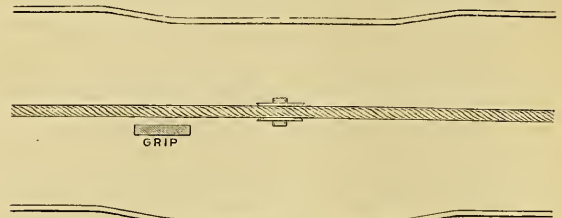

FIG. 8.

that the car and dummy will start themselves or be carried over by gravity.

The driving drums are different from those in use on Clay Street, where the drum has clips on its periphery in principle of action like Fowler's for driving wire ropes; while in Sutter Street there are two single-grooved drums in line with each other, one being slightly higher than the other.

These are so placed that the cable coming in from the street will lead fairly on to the highest, which is in the rear, or farthest from the street. Passing around this, the

cable is led forward and up, over, around and down under both of the drums forming the figure eight nearly. Thence the cable goes backward and round a vertical sheave, which is carried by a carriage which can be moved on ways or rails provided for it. After passing around this latter sheave it goes forward again over the two driving sheaves or drums to the sheave in the street, by which it is again deflected into the tube.

The movable sheave around which the cable passes before reaching the street is arranged with a chain and weight, so that a definite amount of tension can be placed upon the cable, proportionate to its size and the work it has to do. This road has one other feature not in the Clay Street road. That is, horizontal curves. The Larkin Street cable passing

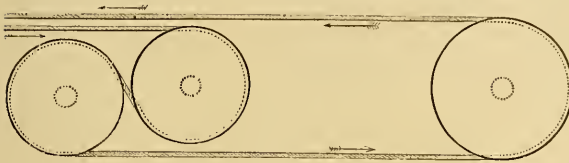

FIG. 9.

a right angle from Polk into Post and from Post into Larkin and back again on the return track for deflecting the cable around these curves, which are from 40 to 50 feet radius; a series of horizontal pulleys, having no grooves—but straight faces with a flange on the lower edge, are placed on the inner side of the curve about three feet apart, so that the deflection from one pulley to the next is slight. These pulleys are about 20 inches in diameter, and are set in iron cases which carry the bearings for the upper and lower journals of the upright spindles or shafts. The cable runs against the faces of these pulleys and they are set far enough to one side of the slot so that the grip in moving along would easily pass them; but to avoid positive contact between the grip and these pulleys, a bar of iron is placed around the curve, just above and a little in advance of the face of the pulleys, and, at a point on the shank of the grip, which would come opposite this bar, is placed a piece of iron called a wearing piece, which, being made smooth, comes in contact with and slides along the bar, thus keeping the jaws of the grip from contact with the pulleys.

The method of applying power to the grip used on this road is by a long lever, the short arm of which forms one part or joint of the knuckle or toggle lever, while the power is applied on the Clay Street grip by means of a screw, or rather to a nut working on a screw, the nut being inclosed in and fastened to the hub of a hand wheel.

The construction of the tube for this road was originally similar to that first used on the Clay Street, that is cast iron frames and a tube of wood, but later the construction of the tube has been made by the use of wrought iron frames reaching to and supporting the rails, and making a skeleton tie for the rails, slot irons and tube, which latter is formed of concrete.

The California Street road, which was the next one built after the Sutter Street, is similar in its conditions to the Clay Street, but having some steeper grades, and as it was intended for heavier traffic a larger cable was used, being one and one-quarter inches in diameter.

The tube is constructed of a frame of wrought iron, reaching out and supporting the rails, which was copied in the later construction of portions of the Sutter Street road above alluded to. In the case of the California Street road, however, the main element of the wrought iron works was made of old rails.

At the location of the engine-house, ground area being limited, the driving drums for the cable were placed under the street, one under and in line with the center of each track. The drums are the same as those used on Sutter street. Tension sheaves are used, the cable passing over them before going onto the driving drums and after leaving them, and before passing into the tube. The action of these tension sheaves was by gravity, but instead of having a

weight attached to the movable carriage which carries the sheave, the track on which the carriage runs in this case is on an incline, so that gravity acts directly upon the carriage and sheave. The carriage is so constructed that weight may be added as desired in a boxed part. Switches are used at the termini for transferring cars and dummies from one track to another, a tube being used for the grip to pass through, the same as on the Sutter Street road. The grip used is the same as on Sutter street, that is a "side" grip.

The Geary Street road is similar in general conditions to the Sutter Street, except that it has no curves, the road being straight from end to end, and the angles at the changes of grade are so slight that no depression sheaves are used to keep the cable down.

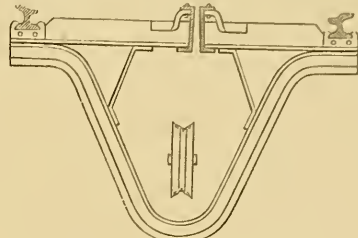

FIG. 10.

The grip used on this road is a "bottom" grip, but is operated by a lever applying the principle of the toggle joint.

The cars are transferred at one end of the road by a switch like Sutter and California streets, but at the other by a turn-table. The turn-table being of a diameter sufficient to hold one car is placed with its center of revolution in a line with the center of the out-going track. The in-coming track is curved, and the straight portion running onto the turn-table forms an angle with the out-going track of about 30 degrees. This economises space, and dispenses with the second table as used on Clay street. The driving drums in use on this road for moving the cable are different from any other road, there being two, and each having several concentric grooves so that the cable is passed around the two drums until a sufficient number of wraps are made to prevent slip. In this case, no tension sheaves are used to give adhesions to the cable around the drum. Four or five wraps of the cable are all that is necessary. The tension sheaves for taking up the stretch and slack of the cable are on moveable carriages, and are drawn backward by a long screw.

The Union Street or Presidio and Ferries road has the steepest grades of any road in the city, and has one horizontal curve, where the line passes from Montgomery avenue to Union street. In this case the cables are led away from the curve of the track, passing around large horizontal sheaves to change the direction of the cable from one street to the other, and the grades at the curve have been so modified, that the cable having been let out of the grip, the train passes the curve by its momentum, assisted somewhat by gravity.

The driving drums are the same as used on Clay street; also the grip.

The transferring of cars and dummies at the termini are by switches, turn-tables being used only at the engine house for turning the cars on and off the road.

The Market Street road, the latest built, has some features different from all others. The construction of the entire railroad bed is the same as California Street, except in the form of iron work of the frame for the latter, which is the same kind of materials as are used on California street. The cars carry the grip instead of having a dummy, as on all other roads.

The driving drums are the same as are used on California and Sutter Street roads. At the junction of Market with Haight and also at McAllister streets the Market

Street cable is dropped, and the cable running in Haight and McAllister streets is picked up, as the car is carried by its momentum around the curves into either of these streets, assisted by gravity due to a grade modified for the purpose. At the curve on Market and Valencia streets an auxiliary cable is used for bringing the cars past the engine house. This cable is used only on one track coming east, the cars going west having to drop the cable and are carried around the curve by gravity. The speed of this cable is one-half that of the main cables and it is driven by a grooved pulley or sheave on the line shaft which carries all the other driving drums.

The cables on Market, Valencia and Haight streets are driven by the same engine, while a separate engine is used for operating the McAllister Street cable. At Haight Street, the curve from Market Street is passed the same as on the Union Street road at Montgomery Avenue and Union Street, but at the junction of McAllister and Market after dropping the Market Street cable, the McAllister Street cable is picked up before reaching the curve, and the grip holds the cable while passing it, the horizontal pulleys around which the cable passes being arranged similarly to those heretofore referred to at the corner of Post and Polk, and Post and Larkin streets on the Sutter street roads.

At the termini of these roads, the Market, Valencia, Haight and McAllister streets, which comprise the Market Street Company roads, the cars are transferred from one track to the other by a turn-table somewhat similar to that used at one end of the Geary Street road, with this difference: On Geary Street the dummy or car is not turned around, but either end runs foremost, so that in changing the turn-table from the incoming to the outgoing track the table is moved through only thirty degrees.

On the Market Street cars the grip is placed on the truck at one end of the cars so that the car requires to be turned half way around at each end of the route. The table in this case has to be moved through 180 degrees, and there are two parallel tracks across this turn-table, each equidistant from the center, the distance between the centers of the tracks being equal to the distance between the centers of the main tracks, so that when the table has been moved so that a car is in position to go off, the other track on the table is in position to receive a car from the incoming main line. As these turn-tables are large and heavy they are turned by gearing driven by the main cable, through a grooved pulley, which being connected with the gearing is brought against the cable with sufficient pressure to give the desired power. The cables used by this company are the size of the ones used on California Street ($1\frac{1}{4}$ inch in diameter).

On McAllister Street where the road crosses to Fulton Street, there are four curves of about forty-five degrees each, with the horizontal pulleys arranged similarly to those on Post, Polk and Larkin streets of the Sutter street road.

These facts concerning the general features of the various roads are incidental to important questions, that of the economy in construction, maintenance and operation of the cable system of propulsion for street cars.

In order to direct an intelligent inquiry into the subject I have divided it into three general heads:

- 1st. Construction.
- 2d. Maintenance.
- 3d. Operation.

Each of these divisions, of course, have many details, but for the purpose of this paper I have made them somewhat general.

Under the head of Construction, I have placed the construction of:

- 1st.—Road-bed and tube.
- 2d.—Driving machinery.
- 3d.—Gripping apparatus and cable.
- 4th.—Cars.

Under the division of Maintenance I have placed:

- 1st.—Road-bed and tube.
- 2d.—Driving machinery.
- 3d.—Gripping apparatus and cable.

Under the division of Operation, I have placed:

- 1st.—Power for driving the cable.
- 2d.—Power for driving the cars.
- 3d.—Power for hauling passengers.

In the construction of the road-bed and tube, it will be noticed that we have advanced from the first experiment of wood and iron to concrete and iron, with stone paving for the surface of the street and with steel for rails. Probably we have gone to the extremes in this respect as far as cost is concerned, for we have constructed the tube and road-bed of the most lasting materials, with all the strength to support the heaviest traffic which will ever be allowed over the streets of any city, the surface being composed of materials which are best known, by experience and judgment, to resist the wear to which they may be exposed; and these materials have been used in a generous manner. The increase in economy will consist in the reduction of material to the minimum required to meet local conditions, and an exercise of careful judgment in the manner and distribution of labor in the combining and placing in position the materials of construction. The apparent cost of similar forms of construction of the road-beds and tubes of the cable roads in this city vary so much that it would be delusive to base estimates of the cost of a projected road upon the generally reported statements concerning the cost of those already built. The conditions to be observed for the street surface are that the grades of the street shall not be disturbed, or that no protuberances or depressions shall be made to interfere with traffic of teams or vehicles, and that the strength of the tube shall be sufficient to easily support the heaviest weight which may ordinarily come upon it without disturbing its shape.

To be Continued.

A Trip Beneath Broadway.

Thousands of persons daily pass over an iron grating about eight feet square that lies just inside the sidewalk which skirts the City Hall Park near the little drinking fountain opposite Murray street. Not one in a hundred has any idea that this grating covers a spot that was intended years ago as a railroad depot, or rather the entrance to one. The discussion recently in the Legislature of the different underground systems made this grating a very interesting object.

The reporter was permitted to go through the vaults underneath the sidewalk, and, preceded by a man with a lighted lamp, to make his way for about twenty feet toward Broadway. A huge wooden door was opened and the reporter found himself in a tunnel. The faint glimmer of the lamp showed that the tunnel was circular in form and iron-bound. It looked like what a huge steamboat boiler must look to the maker before the steam-pipes are put in, with the exception that at every few feet there are iron ribs riveted to the iron sides and roof and reaching to the floor. On both sides of the tunnel bottles and barrels are piled on top of one another, and the man with the lamp explained that this part of the tunnel was used as a storage place by wine houses, but that since the New York Steam-heating Company had placed their pipes on the roof the atmosphere had become rather uncomfortable. Sure enough, as the reporter went in the heat became more intense, and at times it was like a baker's oven.

Not over twenty feet of the tunnel are iron-ribbed, and at the end of the iron limit an object is described occupying the full width of the floor. Close inspection shows it to be a hand-car, such as track repairers on railroads use in going from place to place between stations. Pushing this on before them as the visitor saunters along, and placing the lamp on the floor the easy motion of the car is accounted for. It is on four grooved wheels, which run on narrow rails. A third rail, much narrower than the side rails, is in the middle of the tunnel, and it was explained that this rail was made for the grip of the passenger cars. It will be remembered by those who can remember anything at all about this experimental bore underground for a subterranean railway that

it was to have been run by compressed air. Progress with the hand-car became tedious, and crawling over it the reporter continued on his journey southward. With the exception of that part of the tunnel which is iron-ribbed, it is from end to end lined with brick.

Although not a hand has been put to it since the day all work was abandoned on it, there is not a crack in the brick anywhere, or the slightest sign of a "bulge" in the roof, although the pavement above it has been laid and relaid, huge gas mains have been sunk over it, and the tremendous travel of stage, truck, wagon and finally of horse-cars has rolled over it day and night for fifteen years. Despite the heat caused by the steam company's pipes, there is an absolute absence of that stuffiness of dead air so peculiar to cellars and subways.

When Murray street is reached, which is the southernmost limit of the tunnel, the way is blocked by a passenger car, which sits on the track minus its wheels. It takes up the full circumference of the tunnel, there being only about an inch of space between its sides and the sides of the tunnel, and its roof and the roof of the tunnel. The car is, therefore, even to the floor, circular in shape. It is apparently as high as the ordinary surface street-car, but is much shorter. This car years ago made many trips from one end of the tunnel the other, while the company which made the bore under the street was asking big favors of the Legislature. Passengers who were privileged to make a test of the pneumatic ride considered this car a marvel. But it must be remembered that this was before the day of elevated railroads.

Just to the left of the car the daylight flows* in from a huge circular opening. On approaching it one is led to believe that the light is coming in from a grating directly overhead, but it does not. It is made plain to the visitor why the air is so clear in the tunnel and at the same time revealed the purposes of the grating in the City Hall Park. It requires the services of a ladder to reveal this second tunnel from the track bed, and although it looks from the ground like an air hole it was found to be, like the tunnel itself, a huge bore, brick-lined, and extending under Broadway to the Park, ending at the grating. It is high and broad enough for several persons to walk abreast in it.

The roar of Broadway overhead is distinctly heard in both tunnels, and the noise of the surface cars can be easily distinguished from that made by wagons and trucks. The din made by the car wheels comes to the ears like the distant "long roll" of a drum corps, while the wagons seem to make a rumble that dies away only to break out again every few seconds. One noticeable thing about the tunnel is, despite the hum of human activity overhead two persons standing in it—the one at the Warren street entrance and the other at the Murray street terminus—can converse in an ordinary tone of voice and every word comes clear cut and distinct to the ears of each.

"There was a power of money lost in making that hole," said the reporter's companion, as he blew out his lamp and the visitor merged into daylight again.—*New York World*.

TRAMCARS deriving their power from storage batteries carried upon them are growing in favor. We have recently had occasion to chronicle their employment in an English colliery upon mine locomotives, and we now hear of their successful application to a tramway in Hamburg, in Germany. At Antwerp, where such an electric car came off victorious in competition with other means of locomotion, quite a number are now in daily operation, and Berlin is making preparations for their introduction on an extended scale. The near future will see some attempt made for their application in a similar manner in this country, the ease with which they can be adapted to existing conditions being greatly in their favor.—*The Electrical World*.

A PASSENGER on a Madison street car, noticing the new style of bell-punch for the first time, asked the conductor if that wasn't something new. The man with the "sardine box" replied: "Yes; drop a nickel in the box and hear the birdie sing."

Horses and Mules Fed on Ensilage.

Capt. T. W. Battle, proprietor of "Cool Spring," Edgecombe County, N. C., is spoken of as a model farmer, and of course a successful one. A correspondent of the *News and Observer* (Raleigh) says:

"He has 600 acres in cotton that will rival if not surpass the famed product of the southern bottoms. I think he will make 900 bales, or $1\frac{1}{2}$ bales per acre. His corn crop is excellent and I venture to say can't be beaten this side of the noted corn producing "American bottom." He gives everything his own supervision, buys labor-saving implements and takes care of them, cultivates thoroughly and keeps his crop free of grass. His horses, mules, cattle, etc., are in fine condition and bear witness to his careful attention. He is a great advocate for ensilage; has two silos, and informed me that he fed his horses and mules entirely upon it. He thinks also very highly of the pea crop as an improver; sows on stubble land when it is too wet to plow elsewhere and plows peas in broadcast over his entire corn crop at the last plowing.

THE UNION ELECTRIC COMPANY has recently been operating an experimental electric motor car on Ridge avenue, between 32d and 33d streets, Philadelphia, and has met with very fair success. Each afternoon a car carrying the usual burden of passengers has been run over the track at the rate of nine miles an hour. The system employed is that of underground electrical transmission. A conduit, $4\frac{1}{2}$ inches wide by 9 deep, and having a central slot similar to that employed on cable roads, extends along the center of the track. This has been laid on concrete and covered with Portland cement. At suitable intervals, connections are made with the sewer, in order to permit the rain water to discharge or the conduit to be washed out, should that become necessary. A copper conductor, one-quarter inch deep by one inch wide, runs along the conduit on each side of the slot. A grooved piece of channel iron is attached to the bottom of the conductors. A so-called "traveler," supported by wheels, runs in the slot, and is provided with two springs which slide along the channel irons on each side of the slot, and thus receive the electric current. The traveler is connected to the car by small chains. From its center, wires extend into the car, connecting the motor on board with the copper conductors in the conduit, by which the electric circuit may be closed. A regulator on the car controls the current, and permits the car to be driven in either direction. The trials covered a very stormy period, but it is stated that the bad weather caused no interruption in the working of the system. The estimated cost per day of running the electric car, according to the ledger, is \$1.84, while that of operating a horse car is \$4.74. Neither estimate includes salaries. The cost of ten miles of electric railway on this system, and fifty cars, is stated to be \$175,000.

THE "Amalgamated Society of Railway Servants" in Great Britain has become a powerful as well as useful institution. The 14th annual report shows that the income during the last year amounted to nearly \$72,000, of which over \$32,000 were expended, including \$6,300 for superannuation grants for old age and accidents. This is in addition to the payments for deaths, and for the support of orphan children. The latter especially is a most beneficent feature. During the year 51 children were added to the list, making 265 orphans of deceased railway men now receiving its benefits. At the end of 1885, the membership of the society was 9,052, showing an increase during the year of 592.—*The Railway Age*.

WE are informed, in answer to a query, that a street railway using a 56-pound steel rail costs \$3,500 per mile, complete. This is very low. We do not remember of having a quotation of less than \$4,500, exclusive of removing paving and replacing it, which is an added expense of at least \$700 a mile.

Heating Horse-Cars.

The system described here, and known as the Gold system, has been applied with success in both steam and horse cars. It is one which obtains the attention of engi-

instead of being applied centrally through a small pipe as heretofore, gives, as will be at once seen, a *very much larger steam-heating surface* than could be obtained by the former method. From this it results that, in the short space of time during which a locomotive stops at a station, there is suf-

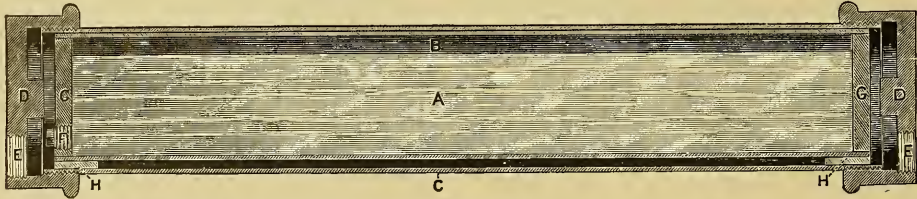

FIG. 1.

neers as being thoroughly practical and efficient, and for which is claimed advantages that are not to be found in any other known system of artificial heating at the present time.

Fig. 1 represents a longitudinal section of a wrought-iron cylinder, A, termed a reservoir for containing water for storing heat. This cylindrical reservoir is filled with a strong solution of common salt to about seven-eighths its capacity. There is ample provision for expansion when heated, and no undue strain ensues when the apparatus is in operation. It being hermetically sealed, the solution is maintained at a constant strength, is proof against freezing, is permanent and enduring.

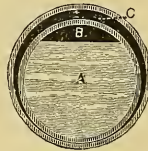

FIG. 2.

The reservoir is supported in a wrought iron cylinder of somewhat larger diameter, upon small supports at the bottom, which leave an annular space, wider at the bottom and gradually narrowing at the top, as shown at C in cross-section, Fig. 2.

This enclosing cylinder is provided with caps D, so

ficient steam heating surface to adequately heat the solution in the reservoir A, when steam is supplied to the space between said reservoir and its enclosing cylinder. As no strain can arise from expansion, no leaks can be so caused, and no expansion joints are needed.

On admission of steam, the outer cylinder instantly becomes radiating surface and heats the car very effectively, while at the same time the reservoir A is absorbing heat for future use. The length and diameter of the cylinder are varied to suit requirements. When, therefore, steam is admitted to these heaters, the heating of the car and of the reservoir commences simultaneously and is continued until the steam is shut off. When that is done, the heat radiates from the reservoir A to the inclosing cylinder, and from there is imparted by the contact of the air and by radiation to the interior of the car, and maintains a comfortable temperature for a long time.

For heating horse cars a small stationary boiler is necessary at the terminus of the trip (when it does not exceed two and one-half hours' duration); the cylinders are placed under the seats, thus saving the space occupied usually by

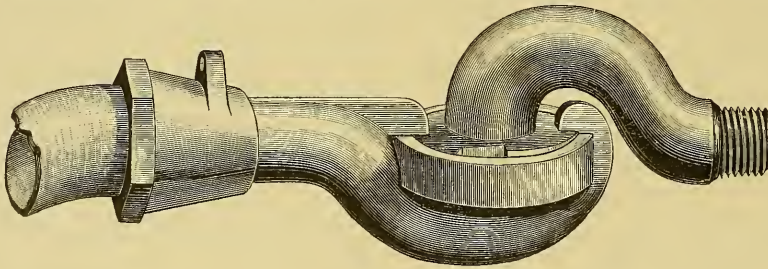

FIG. 3.

adjusted as to leave plenty of room for longitudinal expansion of the reservoir A, in the interior of the enclosing pipe.

In the caps at the lower part of the same are openings E, into which the steam pipes are screwed, so that steam may pass in either direction into the apparatus, and pass

a stove, and diffusing the heat uniformly throughout the car.

Fig. 3 is an exterior view of a coupling used for joining the heating system of the cars when making them up into trains, as in the case of regular steam cars or cars on ele-

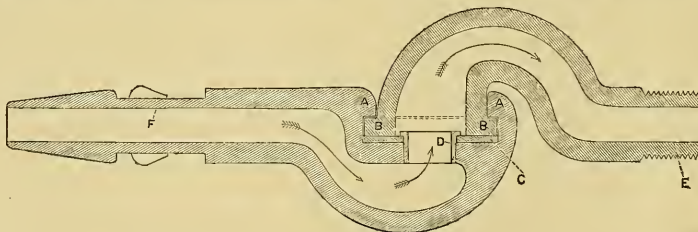

FIG. 4.

freely out at the opposite end together with the water, which has condensed during its passage. The steam being thus applied to the outside of the water-containing reservoir A,

uated railroads. It is also applied to single horse cars as indicated in the diagrams of a horse car.

Fig. 4 shows a horizontal section of this coupling.

Figs. 5, 6 and 7 are diagrams illustrating the use of the apparatus on horse cars.

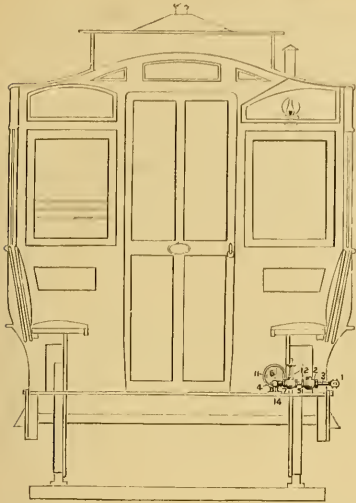

FIG. 6.

EXPERIMENT WITH CAR NO. 136 OF THE NORTH HUDSON COUNTY HORSE RAILROAD COMPANY, MARCH 4, 1886.

| 1 | 2 | 3 | 4 | 5 | 6 | 7 | 8 | 9 | 10 | 11 |
|------------------------------|---|--|---|--|---|---|--------------------------------------|--|---|---|
| Time Car started from Ferry. | Temperature of Cylinder on arriving at Ferry. | Temperature of Car on arriving at Ferry. | Time during which steam was admitted to heat brine in Cylinder during stops at Ferry. | Pressure under which steam was taken from boiler stationed at Ferry. | Weight of water condensed from steam induced to Cylinder. | Temperature of Cylinder on leaving Ferry. | Temperature of Car on leaving Ferry. | Temperature of Cylinder on arrival at Court House. | Temperature of Car on arrival at Court House. | Outside Temperature at time of starting from Ferry. |
| A. M. | | | | | | | | | | |
| 9. 25 | 103° F. | 53° F. | 4 min. | 3½ lb. | 8 lb. | 170° F. | 48° F. | 135° F. | 50° F. | 32° F. |
| 10. 25 | 102° " | 58° " | 4 " | 35 " | 8 " | 160° " | 56° " | 102° " | 56° " | 33° " |
| 11. 25 | 132° " | 62° " | 3 " | 40 " | 2 " | 155° " | 58° " | 132° " | 59° " | 33° " |
| P. M. | | | | | | | | | | |
| 12. 25 | 103° " | 61° " | 3 " | 35 " | 10 " | 137° " | 62° " | 104° " | 60° " | 38° " |
| 1. 25 | 110° " | 64° " | 4 " | 30 " | 2 " | 163° " | 61° " | 142° " | 60° " | 38° " |
| 2. 25 | 105° " | 62° " | 3 " | 40 " | 14 " | 164° " | 64° " | 112° " | 62° " | 37° " |
| 3. 25 | 102° " | 55° " | 3 " | 35 " | 4 " | 155° " | 60° " | 132° " | 60° " | 39° " |
| 4. 25 | 92° " | 56° " | 3 " | 25 " | 5 " | 125° " | 55° " | 112° " | 57° " | 39° " |
| Total Time | Average | Average | Total Time | Average | Total Weight | Average | Average | Average | Average | Average |
| 7 hours | 119° F. | 59½° F. | 27 min. | 34½ lb. | 56 lb. | 153½° F. | 58½° F. | 121½° F. | 58° F. | 36½° F. |

A good steam boiler, housed and properly set, can be relied upon to produce 9 lbs. of steam for every pound of good coal consumed. Therefore, the 56 lbs. of steam condensed in heating the above car for seven hours entailed the consumption of 6.22 lbs. coal, which, at \$4 per ton, cost 1 cent and 8 mills.

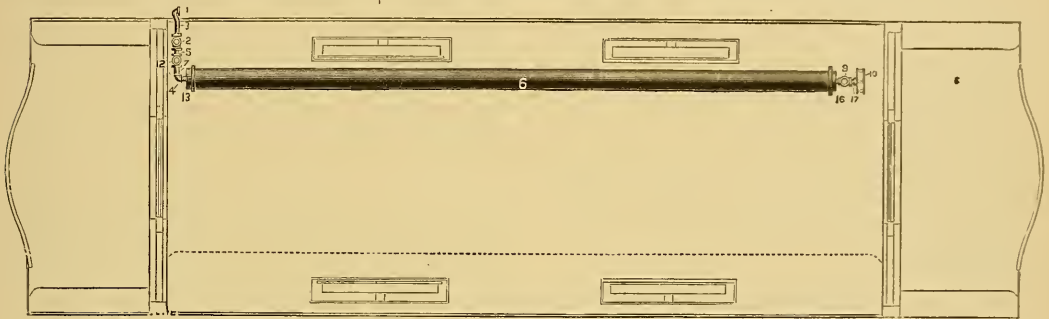

FIG. 7.

1 is the male hose coupling to which the female part of the coupling is attached to supply the reservoir with steam for heating the solution in the internal chamber thereof.
2 is the Check-valve.

3 is the Nipple.
4, Elbow.
5, Nipple.
6, Heater covered with Wire Mesh.
7, Nipple.

8, Nipple through Floor.
9, Cross-valve.
10, Steam Trap.
11, Wire Fender.
12, Gate-valve.

13, Nipple.
14, Nipple through Floor.
15, Nipple through Floor.
16, Nipple.
17, Nipple.

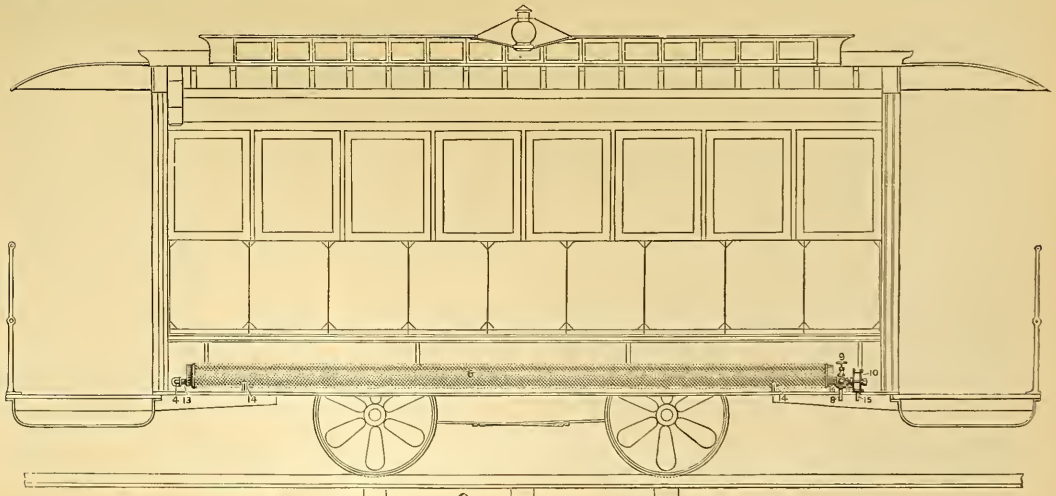

FIG. 5.

THE
STREET RAILWAY GAZETTE

AUGUST, 1886.—MONTHLY, \$2.00 PER YEAR.

COPYRIGHTED JULY, 1886.

THE WRIGHT-MONROE CO.,
PUBLISHERS.

GENERAL OFFICES:

CHICAGO, - - - - - NEW YORK.

CHICAGO,

43 LAKESIDE BUILDING.

P. G. Monroe, - - - - - General Manager.
E. V. Cavell, - - - - - Business Manager.

NEW YORK,

181 BROADWAY, CITY.

H. D. Cozens, - - - - - Business Manager.
T. P. Pemberton - - - - - Associate Editor.

Augustine W. Wright,
Henry C Lockwood, - - - - - } Editors.
George B. Heckel, - - - - - }

BRANCH OFFICES.

PHILADELPHIA, Pa., 24 N. 4th St., J. Waterkeyn, Mngr.

ATLANTA, Ga., Chamber of Commerce Bldg., Wm. Minnigerode,
Mngr.

SAN FRANCISCO, Cal., 1322 Pine St., G. W. Fairchild, Manager.

No lasting reform was ever accomplished by the exercise of physical force.

THE fifth annual convention of the American Street Railway Association will meet in Cincinnati, O., on Wednesday, October 20, 1886.

In the past, black labor was slave to white capital; now the unorganized worker is ruled over by the organized trade-unionist.

THE street-car conductors of Boston are very literary. If you mispronounce a word in conversation or the name of a street they will correct you.

SOCIALISM trains people to depend upon acts of legislation for their support rather than upon their own efforts. The rich would be benefited by this system and the poor reduced to a condition of slavery.

LABOR can do as it pleases with this government in a lawful way, but in an unlawful enterprise it would be mercilessly crushed, because it could never command its own strength in any such undertaking.

WE once heard a man say, who had been graduated at one of our best colleges: "If I could only make something with my hands I might be able to make a living." It is perfectly true that the surest road to success in life—at least such a success that brings support to a family—is through the workshop.

IT is claimed that a certain millionaire statesman, now holding a position in the Cabinet, is connected with a syndicate, whose purpose is to build a railway in the city of Chicago. Capital is needed to construct an elevated road in that city, and this gentleman's money would, undoubtedly, be quite acceptable. A large number of charters wait to be chosen from.

DURING the period of application for legislative authority for franchises to build the elevated roads in New York, there was an active opposition developed in the supposed interest of the surface roads. Time has shown that this policy was short-sighted. The building of elevated roads is now sug-

gested in most of our large cities. Do not let a similar mistake be made by opposing their construction. Rapid transit builds houses, houses must be occupied, business is created, and the increased population are compelled to ride. Each system helps the other.

A GENTLEMAN of our acquaintance, who seems to be possessed of a philosophical turn of mind, claims that street railway companies ought not to pay taxes, which really come out of the pockets of the poor people. Nabobs do not ride in street cars. They may possibly use elevated roads. The authority referred to wants to exempt these companies from taxation, and to reduce the fares to two or three cents a trip, and, as he urges, thus to equalize the burdens of the poor with the rich.

WHILE most drivers of horses are allowed to sit during the performance of their duty, the car driver is compelled to stand. It is believed that this position must be maintained in order that he keep his wits about him; for he must drive and at the same time manage the brake. His position is one of great responsibility. Why does not inventive genius produce a seat that will relieve the driver of his tiresome position and at the same time insure the safety of the riding public.

IT would be quite impossible to estimate the amount of brains and money that has been expended in the endeavor to reach the North Pole. The London newspapers are rather inclined to ridicule the latest American scheme in this direction. Where are the inventors of new motors for street railways. If a surface road be impracticable, how would an elevated or underground road answer. If the ingenuity of these gentlemen were brought to bear on this undertaking, we would soon have rapid transit to this summer resort.

A MAN'S right to work for whom he pleases, or to hire whom he pleases to work for him, is again vindicated by the conviction of three New Haven boycotters. These men undertook to say to the Carrington Publishing Company whom it should not employ under penalty of having its business ruined, and the result is that they have been convicted of criminal conspiracy. Naturally, they do not like it, and the judge and jury will be roundly denounced by all socialistic labor organizations; yet, if they will read the judge's charge carefully they will see that it leans rather toward the side of the accused men than in favor of the prosecution. Despite this, the jury found a verdict of guilty. The most ignorant of the labor demagogues must presently see that it is no use to try to coerce America with the boycott.

Horse Railroad Company.

Neglect: Where a horse railroad company was required by its charter to grade and keep in repair the surface of the street for a space not less than two feet in width on each side of each rail: Held, that where an injury was caused by the defective condition of such part of the street the company was entitled, before being liable to a suit, to written notice of the injury under the statute (Session Laws of 1883, p. 283), which provides that no action for an injury from a defective highway shall be maintained against any town, city, corporation or borough unless written notice of such injury and of its nature and the place of its occurrence shall be given within sixty days. The complaint we must treat as a complaint founded upon the statutory liability of the defendant, and before the plaintiff can enforce its provisions against the defendant he must perform his own duty under it; he must give the written notice prescribed, and the giving of such notice is a condition precedent to his right to maintain the action. This has been so often and so recently decided that it needs no further consideration. (Fields vs. Hartford Horse Railroad Company; Supreme Court of Connecticut.)

Objection.

The only objection to the use of the La Salle street tunnel and to the construction of a cable road by the North Chicago City Railway Company, in the true interests of the people of that city, is now made by the members of the legal fraternity. These enterprising gentlemen are using their persuasive powers with certain citizens of the North Side, to induce them to invest in retainers, in order that a bill in equity be filed to vacate the act that has just received the sanction of the Mayor. The same course has been pursued in New York, in the matter of the Arcade railway. Do the lawyers of these two great cities put their heads together? There certainly seems to be a concert of action, a similarity of attack. According to the lively imaginations of these limbs of the law, the legislative branch of our government is quite defective. The Council in Chicago does not know more than that of New York. The people know less. It seems necessary to ask the lawyers what we may do. Instead of using the courts to cause delay by obstruction, it would be much better to assist in building the road in question, a road that will bring aid, comfort and benefit to the people of Chicago.

Diplomacy.

We regret that our space has not permitted the full recital in our columns of the negotiations that took place some time ago between the Buffalo surface roads and their employés. These negotiations were conducted with much deliberation and forbearance on both sides. In fact, the correspondence that ensued reads almost like the efforts of diplomatists. Everything was conducted between the street railway officials and their employés as between men of sense and honor, Mr. Watson very properly refusing to recognize any club, labor union, or association whatsoever, and the result shows conclusively the advantage employés derive from treating directly with their principals, and not through the medium of organized bodies.

The lessons to be learned from the happy results of direct negotiation are too obvious to require any further comment, and we heartily congratulate both the men, and Mr. Watson and his associates upon the prompt and satisfactory ending of a matter in which so much was involved.

Salt.

A pamphlet has been prepared by the Secretary of the American Street Railway Association which discusses the subject, "Track Cleaning and the Removal of Snow and Ice. Is salt necessary? If so, is its use detrimental to the public health, and especially is it injurious to horses?" The following is an extract from this officer's report:

"From the assistance rendered the Philadelphia companies by the association, in their efforts to be alleviated from obnoxious local legislation against the use of salt for the removal of snow and ice from the tracks, we ascribe the almost unbroken phalanx of members from that city. It is needless to add that their efforts were awarded with success. Other individual places have likewise been relieved.

The greatest victory, however, achieved largely by the publication in question, was that in New York State. The companies had been hampered for years in the use of salt, by the Penal Code, which made its use a misdemeanor. The Code has been amended in this respect, so that the free use of salt is now permitted—a boon to the companies and a blessing to the traveling public."

The Smoker.

The rule controlling smoking in street railway cars differs in various parts of the country. On the New York elevated roads and on a few other lines it is absolutely prohibited. With this rule we have no argument, for the simple reason that we agree with its provisions. On the other hand, however, most lines allow smoking on one or both platforms, or on the three last seats of open cars. One of the lines in New York runs a certain number of cars upon which there is a plain notice to the public, in which smoking is allowed

in any part of them. This is one of the most reasonable compromises of the dispute that has arisen on this subject. Ought the rule which allows passengers to smoke be changed? We decide this question so far as it lies in our power, in the affirmative. The objection to smoking in a public conveyance is so apparent that it seems a waste of time to refute the arguments of those who favor it. The smokers are but a small proportion of the traveling public. As the rule now exists the few are permitted to make themselves disagreeable to the many. This is not true democratic practice, but a kind of license that should not be tolerated. We think it may be safely asserted that, in the summer time, at least, smoking upon platforms, or in open cars is simply, in effect, smoking in the cars themselves. The public by a large majority are opposed to the habit, and this practice of it ought to cease.

To those gentlemen who are so situated in life that they may smoke at any time during the day, and have homes also where they may indulge in the "weed," there is no excuse for them to impose their personal habits upon the general community, nor even the mechanic or clerk, who may have less time than his more fortunate neighbor, should not select the half hour he is riding home to make himself disagreeable to his fellow citizens. One of the great difficulties in the way of the proposed reform is the complacent way in which the smoker regards his segar. He is generally so impressed with the idea that his five-cent Connecticut cheroot is as fragrant to the olfactory nerves of others as to his own. His own family may or may not like the aroma of a pipe, but is it not better that if this incense must be offered up, that the scene of its offering should be transferred from the general public to the hearthstone where the pater familias may settle all questions that may arise. However, if the family combined, or the better-half herself, be opposed, and at the same time stronger than the lord of creation, then he might take a walk around the block and indulge himself to his heart's content.

Smoking tobacco, expectorating and ungentlemanly conduct ought, at least, to cease in public. Railway officials have a certain temporary control over the conduct of a large part of our people, and thus an excellent opportunity is offered them to institute a needed reform in the manners of the traveling public.

Our Boys.

Mere abstract education, not accompanied by genius, by capital or by interest, is so much dead weight to its possessor in the first active steps in life, unless he have a berth ready to receive him. What is needed by the great majority is primary education that will develop the manual as well as the mental powers, and that education should be supplemented by technical instruction. The training of our rising generation ought to be conducted with the definite object of making them fit to earn their living in the state of life to which they may be called. "The acquirement of a handicraft is, as a rule, easier and less irksome to a youth than book-learning; but when the utility and power of knowledge are appreciated, it will be pursued with greater zest, for, other things equal, the educated workman will always take precedence of the uneducated."

COST OF RECENT LABOR DISTURBANCES.—Aside from the reports made by Bradstreet's as to a portion of the loss entailed by the May and June short-hour strikes at Chicago, St. Louis, Baltimore, Cincinnati, New York, Milwaukee and elsewhere, the following totals are furnished in an editorial paragraph by the St. Louis *Globe-Democrat*: Cost of the street-car (Third avenue) strike at New York in wages to the companies, etc., \$1,000,000, and of the leading labor troubles since the outbreak of the last strike on the southwestern railways over \$50,000,000. Both totals are in part based on Bradstreet's calculations as to loss. And now comes a "Knights of Labor estimate" that the cost of the Gould-system strike in wages to the strikers, amounted to \$1,000,000; that the "general board" spent \$100,000, and that the railway companies lost \$3,500,000. The basis for the latter estimate would prove of interest.

The Labor Question.

Never before in the history of the United States has there been so much interest manifested in the labor question as at the present time, and all thoughtful men seem to be studying its problems. The President has brought the power of his mind to bear on the subject, and he has arrived at the conclusion that the Senate is quite unable to cope with it, and he has kindly come to the rescue. The bills now before the Senate and House do not suit him. In any event the President does not wait to veto these bills, but sends a message to Congress recommending a national and permanent board of arbitration, to be appointed, of course, by himself.

"In July, 1884, by a law of Congress," says the President, "a Bureau of Labor was established and placed in charge of a Commissioner of Labor, who is required to collect information upon the subject of labor, its relations to capital, the hours of labor and the earnings of laboring men and women, and the means of promoting their material, social, intellectual and moral prosperity. The commission which I suggest could easily be engrafted upon the bureau thus already organized by the addition of two more commissioners and by supplementing the duties now imposed upon it by such other powers and functions as would permit the commissioners to act as arbitrators, when necessary, between labor and capital, under such limitations and upon such occasions as shall be deemed proper and useful."

"Power should also be distinctly conferred upon this bureau to investigate the causes of all disputes as they occur, whether submitted for arbitration or not, so that information may always be at hand to aid legislation on the subject when necessary and desirable."

But other gentlemen of prominence have recently written upon this question, and Messrs Henry Clews, Rufus Hatch and Stephen B. Elkins have contributed elaborate articles, which have been published in the *North American Review*.

Mr. Clews draws attention to the fact that the Knights of Labor have undertaken to test the application of compulsion as a means of enforcing their demands. He thinks that the point is whether capital or labor shall determine the terms upon which the invested resources of the nation shall be employed. The employer must decide whether his individual rights in his own property are interfered with to such an extent that his freedom shall be lost and his capital impaired and destroyed. To the employé, it is a question whether by force he can wrest to his own profit the most sacred rights of the employer. The condition of things that has produced this issue is revolutionary and has naturally brought about paralysis in business. Mr. Clews thinks that the members of the labor organizations have lost much of the sympathy which was lately entertained for them. Peaceful strikes are harmless, for the reason that emigration to this country could easily fill the vacancies by its new comers. There is no abatement in the increase of population; no limitation of sources of wealth awaiting development, while the practical application of science aids the accumulation of property. He then invites the overcrowded populations of the Old World to the United States.

Mr. Rufus Hatch thinks that the labor organizations were originally started for the benefit of the working men, and all went well until designing men became the leaders, who now play upon the passions of the masses. The burden of the complaint of these leaders is, among other things, that one family has accumulated \$300,000,000 in two generations; of the corruptions in high places; the impurity in governmental affairs; of the pooling of railroad earnings; and of combinations of coal companies to advance the market price. All these things are pondered over, and the laborer asks himself: "Why should not labor organize?" The consequence is that many of the strikes that have taken place have had much justice at the base of their movements.

"When times are good, the country prosperous, and the companies earning and paying dividends," Mr. Hatch recommends that, "the workmen should share in the good

fortune, and when depression comes and the companies are losing money, these same men should consent to a reasonable reduction in their pay. To sum up the whole question, there must be a full and fair recognition of the rights of each, by both the employer and employé; and the latter should be as much interested in, and as much a part of the corporation or company he works for as its road bed, rolling stock, mill or machinery."

Mr. Stephen B. Elkins, the third of these contributors, has examined very carefully and has written quite extensively upon this subject. His conclusions are more scientific and advanced than the productions of the first-named gentlemen. Mr. Elkins has a rose-colored view of the material progress of the United States, which nation has six thousand millions more acquired wealth than Great Britain, while the immigration from Europe, in four years, amounted to over twenty-four hundred thousand people.

While all these favorable conditions exist, the "overcrowding of cities, increase in manufacturing establishments, rapid absorption of public lands, consolidation of wealth, importation of contract labor, and other causes are reproducing in nearly all the States many of the economic and social conditions of Europe. In the midst of great wealth, with powers of production unsurpassed, with material success unparalleled, there is, nevertheless, a social and industrial revolution."

"The question presented by the present labor agitation is both industrial and social, and concerns, not the capitalist nor the wage receiver exclusively, nor the one more than the other, but the whole body of society and the State itself. It involves a great principle, in the presence of which individual interests become insignificant. No question more serious or of graver importance ever came before the American people, and upon its right settlement may not only depend the future of society, but ultimately the fate of the Great Republic."

Mr. Elkins thinks that we have advanced sufficiently under the inspiration of liberty to know that the industrial system should be placed on a better basis; that "strikes, violence, friction between employer and employé should cease, and instead there should be unity of interests, peace and harmony." He believes that the capitalists must learn that it is safer and better to be just, and that supply and demand are not the only laws that should govern the industrial world. The capitalist must learn that wealth is only a trust. On the other hand, the worker must know that the way to aid himself is not through violence and coercion; that thrift, frugality and economy are needed, and that waste and intemperance are his worst enemies.

As in the physical world there will always be inequalities, so in the social, one man will be stronger than another. But because these inequalities exist there is no reason why the laws should not be just and fair, and so framed as to bring the employer and employé into relations that partake of the essential elements of partnership, or, at least, do not suggest the existence of war.

Conditions in Municipal Ordinances.

When an ordinance of a city granting a railway company the right to construct and operate a track along a portion of a street upon certain conditions has been accepted, the rights of the contracting parties will be governed by such ordinance, and the city authorities will be powerless to impose new and further conditions and burdens upon the railway company without its consent, such as the construction and operation of an extended line of its road which it was not required to do under the original ordinance. So held by the Supreme Court of Illinois in the case of *The People ex rel. Bliss vs. The Chicago West Division Railway Company*. In this same case, however, the court left unsettled the question whether a city railway company could be compelled by mandamus to construct and operate a line of railroad along a street in accordance with conditions in an ordinance which it had accepted, where no such duty was imposed by its charter.

The Broadway Railroad Litigation.

The right to operate the Broadway Railroad was restored to the city of New York. The same act provided that the franchise should be disposed of to the highest bidder. The rest of the property was to be sold for the benefit of the *bona fide* creditors.

But the lawyers have not been idle, and they have already found many constitutional objections to the whole legislation. This state of things is serious enough, but to make the matter still more complicated a careful investigation has disclosed the fact of the existence of contracts, mortgages and guarantees without number, and the consequent vested interests that should not be disturbed even by legislation. Then follow the claims of the Broadway and Seventh Avenue Railroad Company and the Twenty-third Street Railway Company; that they were entitled to the use of the tracks by virtue of existing and continuing leases. When the Attorney-General attempted to exercise the will of the legislature, he could find little of any value to possess himself of. His proceedings were restrained and the whole question was involved in the meshes of the law. This wise officer has decided to submit all the disputed points to the Supreme Court of that State for adjudication. He has commenced his suit. The following is a summary of the points he wants explained:

"1. Is chapter 268 of the laws of 1886, entitled, 'An act to annul and dissolve the Broadway Surface Railroad Company,' constitutional?"

"2. Is section 1 of chapter 271 of the laws of 1886, entitled, 'An act in relation to the consents of property holders, order of the General Term confirming reports of Commissioners, and the consents of the local authorities to the construction and operation of street surface railroads by companies which have been dissolved or annulled, or whose charter may have been repealed by legislative enactment,' constitutional?"

"3. Are the second and third sections of said last mentioned act constitutional?"

"4. If said act last mentioned be unconstitutional in whole or in part, does the franchise or right to maintain and operate a railroad in Broadway over the route covered by the road now in existence, revert to the people of the State of New York, or to the Mayor, Alderman, and Commonality of the city of New York, or does it pass to the receiver of the Broadway Surface Railroad Company?"

"5. Were all contracts made by the Broadway Surface Railroad Company, prior to its dissolution by the statute, abrogated by that statute?"

"6. Generally, what was the scope, extent and effect of said three acts of 1886 heretofore referred to, upon the property rights and privileges of the Broadway Surface Railroad Company and the defendants?"

How pleasant it must be for the Hon. Roscoe Conkling to have been employed to bring about legislation that he will probably be now re-employed to defend in the courts. This gentleman has had more to do with the proposal of these big conundrums than any one else, and the public will quietly await their legal solution.

Uniforming Conductors and Drivers.

The custom of putting the conductors and drivers of street-cars in appropriate uniforms, is not common in this country. It is the exception, not the rule, and the occasion is rare when these employés are furnished with any distinctive mark of office other than a small badge, which is often concealed under an overcoat or otherwise invisible.

It is difficult to find any reason for uniforming conductors and brakemen upon railways that will not apply with even greater force to the conductors and drivers upon street-railways. The intercourse of the street-car conductor with his passengers is certainly more constant and frequent than in the case of the conductor upon the ordinary railway, and the driver too, comes in for his share of intercourse with the traveling public. Certainly there should be provision made whereby the conductor and driver should

be instantly recognized, and especially the former. As possession of reins and brake may be considered a sufficient indication of the occupation of the driver, the reasons for putting him in a uniform are not as urgent as in the case of a conductor, but it should be advocated on the ground of symmetry and neatness.

Every street-car passenger has at times experienced difficulty in recognizing the conductor, especially on occasions when the rear platform was crowded with passengers; and on those roads not using the bell-punch or other form of fare-register—they are not many, it is true—there is an uncertainty in the payment of fare as to whether it has gone to the right personage. The average conductor dresses himself in pretty much any manner he pleases, and there is even a great diversity in the style of hats worn. He is hidden behind a pleasing impersonality which more than once is a cloak for some open violation of the rules.

Common-sense calls for the conductors of street-cars to be uniformed in some manner, and also the drivers, though the importance is not so great in their case. The expense of such uniforming need not be great, nor need it extend to the entire clothing. As a rule a coat alone, if sufficiently distinctive, will answer the purpose, or even a uniformed cap, provided it be conspicuous in shape and style, and be plainly marked with the word "Conductor." The public has a right to know the company's servants at sight, without the necessity of indulging in guess-work and running the risk of offending some over-nice masculine passenger who would show marked disapproval at being taken for the official in question.

Another point to be considered, is the increased discipline which would be inculcated. For some reason not easily explained, a uniform does wonders in establishing an *esprit de corps* among employés, and if it be a handsome one there is a proportionate amount of pride displayed in keeping it neat. In sober truth, it cannot be said that the average conductor is very neatly attired, nor is there any very great inducement to such neatness so long as he may exercise free choice in his attire; but the possession of a handsome uniform acts as a very great inducement to tidiness and general neatness of appearance. And certainly if it be a point with a road to keep the inanimate car in a state of neatness, there are equally good reasons why the animate conductor should be correspondingly neat.

Altogether there seems to be every reason why conductors and drivers should be uniformed as attractively as possible, and we may hope that the subject will be among those selected for discussion by the American Street Railway Association at its next session, and that some definite conclusion may there be reached as to the advisability of recommending the measure. The subject is, at any rate, entitled to careful consideration by street-railway managers.

—*American Railroad Journal.*

New Compressed Air Motor.

A Pittsburgh mechanic claims to have invented a compressed-air motor for street-car travel, on an entirely new and economical principle. The front wheels are unusually large, and there are small air-pumps, three inches stroke by three diameter, set in the periphery of the wheels. The force of the air-pump is exerted by the weight of the car over the wheel, calculated at 1,000 lbs. to each wheel. The air thus compressed passes into the hollow hub of the wheel, whence it carries its force into the receiver.

THE city of Cartago contains about 15,000 inhabitants. A valuable concession has been granted to an American engineer for a street railway and two markets for cattle and provision, comprising four miles of street railroad, running through the town and to a suburb (natural hot springs), where a company is now rapidly putting up bath-houses and a hotel, which will make the place the health resort of all Central America and attract people from the sickly region of Panama. There is also a good freight business for the road. All material to be used in construction to be admitted free of duty.

Kings County "L" Men.

The King's County Elevated Railroad Company, as was anticipated by *The World*, has got another black eye. According to the decision of the General Term, the Attorney-General was right in questioning the validity of the company's charter, and therefore it possesses no legal right to construct a line along Fulton street. An adverse opinion was expected by those who are interested in the scheme to build the road, but they were astonished when an application for a reargument of the case was refused without reservation. It is an unusual thing to hold a special term in midsummer, but the importance of the case caused the justices to believe that it was necessary.

Scarcely had the Justices taken their seats than Jesse Johnson appeared and speedily asked for a reargument of the case, on the ground that an action brought by the Attorney-General was pending between the people and the railroad company. Mr. Johnson declared that so much was at stake that the appeal from Justice Cullen's decision ought not to be passed upon until the case brought by the people was decided. Rapid transit for Brooklyn was the point at issue, and he begged that all the evidence should be carefully considered before a final opinion was handed down.

Ex-Judge Shea, in his address, pressed home the statements that since the previous hearings additional evidence had been secured which the counsel desired to put in. The Legislature had declared that the franchise granted to the Common Council in 1879 was perfectly valid. The question as to whether the consent given in that year was still in force had never been argued before the General Term, and it was the desire of the representatives of the company that the matter should be presented intelligently and fully.

Gen. Wingate, who serves the Union Elevated Railroad Company as counsel, assured the Court that it was his understanding that the case of the people was brought after the condemnation proceedings of Mary Duane and John O'Brien. The motion was not based upon the assumption that the Court had made a mistake on any legal question, and, so far as he was aware, there was nothing new to argue.

The Justices, after listening some time to the arguments of counsel, declined to entertain the motion. Justice Dykman then handed down the decision, sustaining that of Justice Cullen. It is a long drawn out and verbose document. After reviewing the history of the railroad company and the case, the opinion says that the prevalent rule of law is that the legal existence of a railroad corporation armed with full power to construct a railroad, lies at the foundation of the right to condemn property for its use, under the right of domain. That requirement necessarily implies the continued existence of such corporation, in the full possession of all its corporate powers and functions without limitation or restriction, and if by non-performance of the condition of its charter any of its corporate rights are forfeited or lost, the fact may be asserted to defeat an application for the acquisition of property by the exercise of the right of eminent domain. Even if its corporate existence be not at an end its powers are so restricted as to create a disability to exercise its functions. All its powers were forfeited to the Supervisors. It had alienated its right to franchise by a failure to perform the condition upon which the continuance of its existence depended, they had passed from it, and with them departed all its powers of aggressive action. The opinion concludes with this observation: "Our conclusion is that the petitioner has sustained a loss of its corporate powers and is resting under a disability and incapacity which destroys its rights to institute proceedings for the condemnation of private property for public use."

Gen. Wingate serenely waited for the document to be read before he presented a petition for the appointment of Commissioners to take evidence as to the desirability of the Union "L" road. When Justice Barnard asked if the petition was opposed, Jesse Johnson remarked rather savagely that it was rather uncanny, to say the least, to coerce property owners who had already given their consent to the construction of the Kings County road. As for himself, he

had received no notice that the application was to be made, therefore he was not prepared to deal with the matter.

Justice Dykman remarked that he could not see, for the life of him, how the people could be coerced. They generally carried out their own wishes.

The Justices determined to grant Gen. Wingate's motion, and suggested the names of Thomas S. Moore, Walter Livingston and William Marshall as Commissioners. Anthony Barrett interposed the objection that the first and last named gentlemen are interested in other Brooklyn railroads. The Justices signified their willingness to appoint Gen. John B. Woodward in place of Mr. Marshall. Before the name of the other Commissioner was decided upon, Lawyer Barrett withdrew the application, saying that another attempt would be made to secure the consent of the property owners. So far as the decision in the case of the Kings County Company is concerned, the Court of Appeals will no doubt be called upon to pass its opinion.

The Third Avenue Road.

The Third Avenue Railroad Company of New York, proposes to convert its lines to the cable system. The driving plant will be located on Third Avenue, near Sixty-fifth street. The road will be built in sections; one from Harlem to the Sixty-fifth street depot, another from this depot to Sixth street, and the third from Sixth street to the terminus at the Post Office. In the different sections the cars may be run at different rates of speed. A new set of cars, from 200 to 250, will be required, each built to seat thirty-six passengers. The length of the road will be eight miles. New tracks will be laid, and the roadway will be paved with Belgian blocks. The cable will be laid in a conduit, with a slot a little less than $\frac{5}{8}$ inch wide. The tube will be thirty inches deep, and eighteen inches wide at the bottom. Every five feet there will be a cast iron yoke, in which the tube will be set, and the rails will be bolted to this yoke. The grip used will be the same as that now used on Tenth avenue. The entire system will be duplicated, so that in the event of the cable snapping, a second one can be set in motion.

Where They Drew the Line.

"Excuse me," he said, as he halted a gentleman in the corridor of the City Hall, "but will you lend me your eyeglasses a moment?"

He put them on his nose to read a letter, and he returned them with:

"Thanks! Have you the correct time? Ah! Ten-thirty!"

He set his watch and confidently inquired:

"Haven't any tobacco about you, eh?"

He was handed a box, and after helping himself to a liberal share he remarked:

"I want to mail a letter in the box here, but I find I have no postage stamp. If you——"

He was handed a stamp. When he had licked it on and mailed his letter he said:

"I am going up Michigan avenue to Twelfth street. Do you happen to have a couple of street-car tickets?"

"Sir! This is too much!" exclaimed the other. "I can stand about so much, but after that——"

"There! There! Beg your pardon! How did I know you drew the line on street-car tickets? No offense—none in the least. I'll take your name and make a memorandum of where your generosity ceases and this thing shan't happen again. I mistook you for a gentleman who draws the line on paying for the coupé when I ask myself up to his house to supper."—*Detroit Free Press*.

At a factory in Berlin daily trials of electric street-cars are being made, and it is expected that they will soon be adopted by the Berlin companies.

HACKMEN, truckmen and car drivers are sworn enemies, and swearing enemies as well.

American Street-Railway Association.

President—Julius S. Walsh, *President Citizens' Railway Company*, St. Louis, Mo.

First Vice-President—William White, *President Dry Dock, East Broadway and Battery Railroad Company*, New York City.

Second Vice-President—C. B. Holmes, *President Chicago City Railway Company*, Chicago, Ill.

Third Vice-President—Samuel Little, *Treasurer Highland Street-Railway Company*, Boston, Mass.

Secretary and Treasurer—William J. Richardson, *Secretary Atlantic Avenue Railroad Company*, Brooklyn, N. Y.

Office of the Association, cor. Atlantic and Third Avenues, Brooklyn, N. Y.

The fifth annual convention of the association will meet in Cincinnati, O., on Wednesday, October 20th, 1868.

Personals.

L. W. SANBORN.

Mr. L. W. Sanborn, *President of the College City Street Railway*, of Galesburg, was one of our recent callers. He is building an extension to his road of two and a half miles. Steel rails will be laid.

THOMAS A. EDISON.

Mr. Edison is studying ether currents and their availability for telegraphic purposes. He will build a new laboratory for himself at Llewellyn Park next year.

CHARLES FRANCIS ADAMS.

Mr. Charles Francis Adams is said to have joined a syndicate to purchase the Kansas City Street Railway.

W. W. HANSCOM.

Mr. W. W. Hanscom, who has been attending the "brake tests" at Burlington, Iowa, for the two weeks, has been compelled to return to San Francisco without coming farther east, as he anticipated.

E. R. POWELL.

Nellie, the youngest daughter of E. R. Powell, proprietor of the street-car line, met a painful death July 25. She, in company with several companions, was upstairs playing with a Japanese lantern, when her dress took fire. She ran screaming downstairs, but before the flames could be extinguished she received injuries from which, after several hours of intense suffering, she died.

Pointers.

ALABAMA.

Birmingham.

A street railway company has been chartered for this city by J. C. Westbrook and others.

Elyton.

The Land Company's Boulevard Street Railway of this place has recently been opened. The line runs through the Highlands, connecting the town with that suburb and Lake View Park. The line is to be worked by dummy engines.

Montgomery.

If the Capitol City Street Railroad Company of Montgomery is satisfied with the working of its line by electricity, it will be the first city in the States to have all its street cars run by electricity.

ARKANSAS.

Hot Springs.

Mr. T. W. Baxter, of this place, proposes to build an inclined plane railroad at Eureka Springs, to the top of West Mountain, where he intends to erect an observatory and lay out pleasure grounds.

CALIFORNIA.

San Francisco.

The strike of 200 car driver and conductors on the North Beach & Mission and City Railroad Companies, which was inaugurated July 15, assumed a serious aspect. The North Beach & Mission Road, fearing trouble, stabled all its cars before dark. The City Railroad continued running their cars, but soon after dark about

4,000 people gathered on Mission street, between Fourth and Sixth streets, and as the company's cars passed they were saluted with showers of stones and other missiles. An attempt was also made to derail the cars by placing scantling across the track. The obstructions, however, were removed by the police. Finally three cars were stopped, the horses unhitched, the windows broken, and the drivers and conductors were forced to leave. One car was upset across the track. The police were unable to cope with the crowd, and sent for reinforcements. They finally succeeded in dispersing the crowd. Four rioters were arrested.

*** COLORADO.

Denver.

The Denver Electric Street Railway is progressing, and the track is going ahead.

The Tramway Company has been incorporated. Capital stock, \$500,000. Rodney Curtis and others, incorporators.

*** DAKOTA.

Huron.

Under the new charter, material has been purchased, and it is expected that the street railway of this place will be in operation at the meeting of the State Fair in the early part of September next. Mr. William P. Love is the projector of the road.

*** DISTRICT OF COLUMBIA.

Washington.

A syndicate of Philadelphia, Washington and Baltimore capitalists is seeking a charter from Congress for the purpose of operating cable railways upon eligible routes in this city. Among the names mentioned in the list of persons who ask for a grant of the franchise are those of Col. W. W. Dudley, ex-commissioner of pensions, B. H. Warner, James E. Fitch, William Galt, and other wealthy business men of this city.

*** FLORIDA.

Palatka.

A street railway company has been incorporated at this place.

Tampa.

The street cars at this place are hauled by steam engines.

*** GEORGIA.

Atlanta.

The Metropolitan Street Railroad Company of this city has commenced giving contracts at Grant Park, to which place its cars run.

Covington.

W. C. Clark & Co. are interested in a new street railroad at this place.

Macon.

The street railway of this city is to be doubled tracked as far as possible.

*** ILLINOIS.

Chicago.

The Chicago Electric Elevator Railway has been incorporated; capital stock, \$5,000,000. E. B. Payne, Enos Slosson, 128 South Clark street, and A. B. Graham are the incorporators.

The Cross-town Passenger Railway, at Chicago; capital stock, \$1,000,000; incorporators, John J. Curran, John B. Ryan and Frank Binz.

The Chicago Passenger Railway Company have laid a single track on Washington street, between Michigan avenue and State street, and is tearing up the thoroughfare westward toward the tunnel.

At a meeting of the Lake View Board of Trustees, on the evening of the 26th of July, Mr. Yerkes was present. Four ordinances were presented by the board and one by Mr. Yerkes. The ordinances prepared by the board grant franchises for cable roads on Lincoln avenue, between Fullerton and Belmont avenues; on Clark street, between Fullerton and Diversey avenues; on Clark street to the north line of the town, and for a road on Halsted street through the town. The ordinance presented by Mr. Yerkes is for a line on Clark street through the town for twenty years. This is to be operated with "bob-tailed" horse cars. The fare shall be

five cents for a continuous ride south of Belmont avenue on all connections, and five cents north of Belmont avenue. Mr. Yerkes told the trustees last night that it costs \$300,000 a mile to build cable roads, and that the "bob-tailed" cars which he will put on Clark street are better than any other style.

The exact terms of the treaty arranged on Monday between Yerkes and the drivers and conductors of the North Side street cars are now known. The president agreed to pay twenty-five cents for every hour's work beyond twelve hours. Thus the Sedgwick street men, whose day consists of thirteen hours and twelve minutes, will receive \$2.50, and the men will be paid all around for such extra work as picnics and special occasions entail, whereas they have heretofore done this work gratis. The schedule of graduated wages is also changed. Whereas the men who have heretofore been required to serve an apprenticeship of one year to receive full pay, they will now begin at \$1.50, as formerly, and be raised to \$2.25, at the rate of twenty-five cents per day every month. The four "trippers" on Larrabee street were converted into "set cars."

"Trippers" are reserve cars held for morning and evening rushes and other exigencies created by the press of travel. "Set cars" are those that run regularly all day. Thus the "tripper" drivers and conductors, who have been compelled to loaf the greater part of the day at \$1.50, will be given a full day's work at \$2.25, and the public will be accommodated by four extra cars continually running on Larrabee street. These are the full terms of the compromise, the men having postponed their demand for a straight increase in pay until the cable system is introduced.

President Charles T. Yerkes, of the North Division Railway, accompanied by Peter A. B. Widener and George W. Elkins, of the Philadelphia syndicate, called upon Mayor Harrison on the afternoon of July 27. They indicated their intention to accept the tunnel ordinance and commence operations at an early date. The Mayor particularly urged upon them the advisability of erecting a new bridge at Wells street before fall, and they announced that the company was already considering that proposition, and would probably take the necessary steps toward the accomplishment of that object. All the parties agreed that a new bridge at Wells street was a pressing necessity. The call was very pleasant one, and none of the gentlemen intimated that he was paying too much for the valuable franchise granted them by the city.

A meeting of West Side property owners interested in securing a cross-town street railroad was held on the evening of July 25, at Curran's Hall, No. 350 Blue Island avenue. The committee on route reported that it had selected for the proposed line, beginning at Twenty-second street, Ashland avenue, north to Fourteenth street, to Union, to Twelfth, to Desplaines, to Taylor, west to Campbell avenue, south to Twelfth, west to California avenue, south to Twenty-second, and along Twenty-second street to the starting point, making a continuous line. An amendment was made substituting Newberry avenue from Fourteenth to Taylor for Union to Desplaines. August J. Bloom suggested that the line run west on Fourteenth to Douglas Park, and Chairman J. J. Curran liked the change. It is understood that a bridge would be built over the river at Taylor street. It was the purpose of the company to ask the property owners along the line for the frontage, the property holders to get the first opportunity to sign for stock in the company. The money, it was proposed, was to be paid at ten per cent. a month while the road was being built. Those who could serve the company as artisans or laborers might pay for their stock in work. Sub-committees are to be appointed along the proposed route. The railroads could be crossed by viaducts and the road could be run to the corner of Washington and State streets, R. L. Martin, James Taylor, P. C. Herrity, George P. Bunker and Nicholas Simons were appointed a committee to secure from the property owners the frontage. After the right of way has been secured the petition to the City Council to allow the road to be operated will be made. Over \$45,000 has been subscribed already.

Mr. S. H. Terry, of Chicago, the inventor of a new grip and cable system, was before the committee July 20, at the latter's invitation, and explained to them the merits of his system, which makes possible a cable line twenty miles long of four systems operated by one plant. If satisfactory arrangements can be made by the committee for the purchase of the patent, and if the proposed consolidation can be brought about, horse-power will be done away with and every street car in the city will be moved by the cable.

* * *
INDIANA.

Logansport.

At Logansport the street railway company has petitioned the council for the exclusive power to use electricity or hot-air as tractive power. The company intends to do away with mules.

* * *
KENTUCKY.

Louisville.

The Fourth Avenue Park Railway Co. has been organized at this place.

* * *
LOUISIANA.

New Orleans.

Another trial was made July 22, on the Carrollton Railroad, of the ammonia motor invented by Mr. P. G. McMahon. The special object of the trip was to give the members of the Streets and Landings Committee of the City Council an opportunity to see the workings of the machine. This committee have under consideration an application to allow the running of the motor on the St. Charles Avenue Railroad to Canal street. The distance from Napoleon Avenue to Carrollton was made in thirteen and a half minutes. The principle involved in the motor is the expansive power of highly condensed ammonia gas, which is applied to motive machinery much in the same way as steam. The great difficulty first experienced in the use of this agent was the freezing action of the ammonia, which interfered with the working of the machinery. This difficulty has been obviated.

* * *
MASSACHUSETTS.

Boston.

The following committees of the Boston roads have been appointed to take into consideration the question of consolidation under one management: On the part of the Metropolitan road, Calvin A. Richards, the president; ex-Mayor A. F. Martin and Dr. William A. Kust, directors; on the part of the Highland road, President Moody Merrill, Treasurer Samuel Little, Director Samuel Atherton. These committees have had several conferences, the last of which was at the Parker House, and they are nearly ready to report a plan of consolidation to the full boards of directors. It is expected now that one more meeting of the committee will be all that is necessary to perfect the plan.

At Boston the Meigs elevated line has been successfully tried before a legislative committee, the train passing the sharpest curve and the heavy grade of 345 feet to the mile with perfect ease.

Gloucester.

At Gloucester the car-stables are nearly completed and cars are running between Eastern Point and the depot.

Lawrence.

Plans are under way for extending the Lawrence Horse Railway to North Andover Center and Andover, some five miles, under the management of a committee of Andover citizens.

Lawrence, Mass., has a company with a capital of \$1,000,000, to manufacture an electric engine to propel street cars, the invention of C. A. Jackson, of Haverhill. The engine can be worked by a dynamo or battery, and the idea is to run it by storage batteries.

Natick.

The Natick and Cochituate Street Railroad Company has elected the following directors at its first annual meeting: Harrison Harwood, William H. Bent, George S. Trowbridge, O. A. Felch, Frank H. Hayes, George F. Keop and John O. Wilson.

Naumkeag.

The Naumkeag Street Railroad Company has opened its branch to Wenham.

New Marlboro.

At New Marlboro the Konkapot Railroad Company is to be incorporated. Capital not to be less than \$50,000, nor more than \$150,000.

Newton.

A bill has been reported to incorporate the Newton Street Railway Co.

North Adams.

The Hoosac Valley Street Railway was not abandoned after all, and is now under construction. The objection was not to the line, but to the manner in which it was originally designed to be carried out. The locomotives have been delivered at North Adams and are reported to be similar to those in use on the elevated railroads.

Plymouth.

The Plymouth & Kingston Street Railway Co. has a capital stock of \$20,000. D. Thurber is president.

South Worcester.

The Citizens' Street Railway Company is to build immediately a large barn for their use at South Worcester.

Winthrop.

The electric railway is to be built at once. It is in good hands. The Boston *Globe* says: "The cost for construction, repairs and operating expenses owing to the nature of the same will be exceedingly light, and the gentlemen at the head of the enterprise, all men of business reliability, have demonstrated that allowing no increase whatever over the number of people carried by the omnibuses of the present time, they will be able to earn a handsome dividend upon the capitalization of the company."

Worcester.

The new street railway company at Worcester has sold out to the old company, and will consolidate with it when permission is obtained from the Legislature.

* * *
MICHIGAN.

Battle Creek.

The Battle Creek Street Railroad Company has been incorporated by H. H. Brown, Lucius Clark, South Bend, Ind., and H. C. Miller, Chicago. Capital, \$35,000.

Detroit.

At Detroit a company has been organized to build a street railway from the end of the Congress street line to the suburban town of Springwells. The line is to be worked by electric motors.

Grand Rapids.

At Grand Rapids the city authorities have passed a resolution declaring a street railroad on certain streets to be a public necessity, and providing that if the present company does not commence within a stated time, other parties shall be permitted to do the work.

* * *
MINNESOTA.

Mankato.

The Mankato Street Railway Company has filed articles of incorporation. W. W. Farr, S. Lamm, and others, all of that city. Capital, \$50,000.

Stillwater.

The Stillwater Street Railway Company has been incorporated with a capital stock of \$100,000.

* * *
MISSISSIPPI.

Vicksburg.

Supt. T. M. Smedes, of the Street Railroad Company of this city, returned July 12 from Montgomery, Ala., where he went to inspect the workings of the electric railway now in operation in that city. The Street Railroad Company are putting down tracks on the principal streets here, and in some parts of the city, owing to the heavy grade, it is not practicable to run the cars with horses or mules, and the company will probably adopt the Van Depoele system of electric railways.

MISSOURI.

Kansas City.

The incorporation is announced of the Kansas City Electric Railway Company, by W. W. Kendall and others, with a capital stock of \$10,000.

Charles Francis Adams, Charles Merriam and Nathaniel Thayer confirm the report that a Boston syndicate, of which they are members, has purchased the Kansas City Street Railway.

The Kansas City Cable Railroad Company has elected the following officials—President, W. J. Smith; Vice-President, P. A. Chase, of Boston; Secretary, W. H. Lucas; Chief Engineer, Clift. Wise.

St. Louis.

At St. Louis the Mallinckrodt brake is being experimented with on the Fifth street line. The driver can stop gently on ordinary occasions, but upon emergency can stop the car in from three to six feet.

At St. Louis, Thos. O'Reilly has applied for a franchise to build an electric elevated railroad four and a half miles long. The line to be constructed in the middle of the street.

The moving of the new cable for the cable road from the railroad track to the cable conduit on Sixth and Locust streets, has been attended with serious difficulty. Experience with the first cable led to the building of a truck with low wheels and tires nine inches broad. Its axles were seven inches in diameter, the axle boxes each weigh 150 pounds, and the entire vehicle weighs 1,700 pounds. The axles used are of the patent manufactured by the National Tubular Axle Company, of McKeesport, Pa., of which the Paddock-Hawley Iron Company, St. Louis, have the agency for the Southwest. These axles have polished, case-hardened spindles, and can with difficulty be broken. It was thought that this truck would transport the fifty odd tons of cable to its destination without any particular damage to the streets. Not so, however, the moving of the cable having been stopped by the city authorities after it had reached the vicinity of Market street on Eleventh street. Its course to that point was marked by great damage to the granite-paved streets, its track being as clearly defined as that of a carriage in deep dust. How it will be moved the rest of the way remains to be determined. Two plans are proposed—one to board up the spool and roll it along, the other to use heavy sections of boiler iron for the truck to run on. The latter plan was tried, but proved only partially successful, as damage to the streets resulted.

A movement to unite all of the street railway companies of this city into one, to be under one management, with a trust board at the head of affairs, is on foot. The plan is said to have been suggested as one of mutual protection against excessive competition and a resulting cut in fares, the directors of some of the older companies believing that a remunerative business can be carried on by reducing the fare from five to three cents. The contemplated cut by these roads has alarmed the others and a plan of consolidation has been proposed. A committee has been appointed to ascertain if such a scheme is practicable, and they have agreed to report, it is believed, favorably.

* * *
NEBRASKA.

Omaha.

The Omaha Tramway Company has decided to build two miles of line at once and to erect a building for the plant.

* * *
NEW HAMPSHIRE.

Manchester.

At East Manchester the street railway is to be extended along Hall and Park streets to Massachusetts street.

Nashua.

At Nashua the street railway company has held its first annual meeting and re-elected the same board. The cost of construction has been \$16,350. The tracks are now laid to the railway depot.

NEW JERSEY.

Beach Point.

The cars will be run as usual on the Beach Point Railroad, the difficulties which threatened the road having been disposed of.

Plainfield.

A New York syndicate proposes to build a street railway in Plainfield.

NEW YORK.

Brooklyn.

The railroad talk on the street is that the Union Company, after it receives permission of the Aldermen to build, will make application to the Supreme Court for its permission, through a commission, to construct and operate its routes, instead of making a long canvass for the permission of a majority of the abutting property owners. It is not expected that the Alderman will act on the application of the Long Island Elevated Railway Company until after their summer vacation.

A. H. Mathesius, whose system of cable road we have previously referred to, has obtained a franchise for a road from Wall street Ferry, Brooklyn, to the top of the hill on Montague street. This covers private property belonging to Henry E. Pierpont. This is about one-third the distance from Wall street Ferry to City Hall. A company has been organized to build a cable road on Mr. Mathesius' plans from Wall street Ferry to City Hall, Brooklyn.

President Hazard, of the Brooklyn City Railroad Company, has granted permission to a New York firm to put electric light in several street cars. The battery which will supply the electricity will be placed under the seats.

Citizens of the Eastern District are delighted with the new open cars which the Brooklyn City Railroad Company has placed on the Flushing avenue line. The new cars are roomy and comfortable, and much more agreeable than the old stuffy closed cars. The open cars are twenty in number, and they are the first open cars ever run on this line. They are largely patronized while the closed cars run almost empty. If the travel demands it the company intends to run extra trips on this line during the summer months. While the Flushing avenue sewer has been in process of construction the Brooklyn City Railroad cars ran on Wallabout street for a distance of about twenty blocks. The new stable of the Brooklyn City Railroad on Flushing avenue between Marcy and Nostrand avenues is now completed. It is a handsome three-story brick building, and will be an ornament to the neighborhood.

Mr. Richardson, President of the Atlantic Avenue Railroad Co., has applied to the Common Council for authority to substitute cable for horse traction from Fulton Ferry to the Prospect Park and Coney Island Railroad at the city line.

The Atlantic Avenue Railroad Company has been authorized to purchase the Prospect Park and Coney Island Railroad.

The Union Elevated Railway directors have made rapid strides recently in their work of pushing forward plans for beginning the construction of their roads. Surveys have been completed on Fifth and Flatbush avenues, and nearly completed on Fulton street and Myrtle avenue.

Since Justice Dykman's decision against the Kings County Elevated Company was made public the Union Elevated Company has been voluntarily given the consents of owners of property on all their routes, representing in value over \$200,000.

The largest property owners on Fifth avenue are rapidly coming into line for the Union Elevated. Influential residents of the Twenty-second and Eighth wards say that by the first of September the Union Elevated will be in possession of a large majority of the consents of the owners of property abutting Fifth avenue.

Many property owners on Broadway also welcome the advent of the Union Elevated, and have, without being asked, given consent to the building of the road. It is the general opinion that the Union Elevated will be able to build its road on Broadway, between the Ferry and Lexington avenue, in less than twelve months from the present time.

The Brooklyn City Railroad Company would be conserving their own interests and greatly accommodating the public, and make it more comfortable for their employees and horses if they would erect a shelter at the foot of Fulton street sufficiently large to cover the railroad tracks there. Passengers landing from the Fulton Ferry and Brooklyn Annex boats would then be under cover and sheltered from rain, snow and heat. Provision could be made for watering and cooling the horses in a cleanly manner during summer, and an open, plain, but tasty structure would be a decided improvement. As it is, passengers, employees and horses are exposed to the weather while waiting, and there are discomforts enough for all without being obliged to bear with this.

Expert Accountant Brown, of the Board of Audit, has just finished his examination into Bridge Secretary Hendrix's accounts, and has sent the following report to Comptroller Brinkerhoff:

Under date of September 15, 1885, I reported to you having examined the Income and Maintenance account of the Trustees of the New York and Brooklyn Bridge up to August 1, 1885. By your request I have continued the examination from that date up to May 1, 1886, covering a period of nine months, and beg leave herewith to hand you a report of the same, of which the following is a synopsis:

| | | |
|--------------------------------------|-------|--------------|
| The balance July 31, 1885, was | | \$255,991 80 |
| The receipts from tolls were | | \$518,041 30 |
| The receipts from interest were | | 4,841 99 |
| The receipts from other sources were | | 437 47 |
| | | \$23,320 76 |
| Making a total of | | \$779,312 56 |
| The disbursements were, by check | | \$705,140 95 |
| The disbursements were, by cash | | 168 04 |
| | | 705,308 99 |

Leaving a balance on hand May 1, 1886..... \$74,003 57

Of which amount there is on deposit in the Long Island Bank \$30,344.85; in the Commercial National Bank of the City of New York \$18,223.74; in the Brooklyn Trust Company \$25,190.31, and petty cash on hand \$244.67, all of which is verified in the accompanying report.

It is but proper to remark that in the disbursements by check there is included the payment to the cities of New York and Brooklyn respectively the sum of \$90,000 and \$180,000, which amounts (together \$270,000) taken from \$705,308.99 leaves the actual amount disbursed for maintenance as \$435,308.99.

Canandaigua.

The Canandaigua Street Railroad Company, capital stock \$30,000, has been incorporated by F. Chamberlain and others.

East New York.

The East New York, Bay Side and Ozome Park Railroad Company is about to lay its tracks in New Lots, L. I.

Jamestown.

The Jamestown Street Railroad Company recently had a switch torn up by order of the City Council; subsequently, however, the company obtained permission to relay the same switch.

New York.

An experimental trial of a new electric motor was made recently on the Thirty-fourth street branch of the Third Avenue Elevated Railroad.

The Tenth avenue cable cars are expected to be running to Eighth avenue soon, avoiding the present change from horse to cable traction at Tenth avenue.

Judge Barrett, in the Supreme Court, has granted a temporary injunction at the instance of John Jacob Astor, against the New York Arcade Railway Company.

The New York extension of the bridge is rapidly approaching completion, and in a few days the iron work will be done and the carpenters and track-layers will get to work. The entire structure, it is expected, will be finished in August. The total receipts for the week ended Sunday, July 25, were \$13,033.10.

The New York Cable Railroad Company claim that, under the decisions of the Courts, they have a right to construct fully sixty-eight miles of cable road, and will appear before the Court of Appeals, in October, to have this view affirmed.

The Arcade Railway, the metropolitan three-tier road, one of whose divisions is capable of going underground, the Terminal Underground Railroad and the District Railway, are to have another rival, according to present indications, for the privilege of rapid transit under ground in this city. An effort, at least, is being made for the revival of the old New York City Central Underground Railway Company. The corporation came into existence in 1865, and among the incorporators were W. Butler Duncan, William B. Ogden, James M. Brown, William E. Dodge, J. S. Thayer, Henry W. Slocum, Henry E. Davies, H. Horace E. Deming, John Fitch, Isaac Bell and John T. Conover. The proposed route of the road began at Broadway and Chambers street, ran east to Chatham street, thence to Mulberry street, up that street and thence under Lafayette Place to Fourth avenue, to Union Square, to Broadway at Nineteenth street; there the route divided into two, one going under Madison square to Madison avenue, and to the Harlem river, the other up Broadway to the grand circle at Central Park. The road is generally known as the Vandenberg venture, as its principal promoter was Origen Vandenberg. The company went far enough to get into debt, and mortgaged its property to Henry M. Alexander and George Hunter Brown, in 1873, as trustees. Suit was brought by Mr. Vandenberg against the company, the trustees and the city for sums due him. Judgment was obtained in the Special Term of the Superior Court, and in 1876 the road and its charter were sold at public auction and bought in by Mr. Vandenberg.

That gentleman is now seeking to revive the charter, and to effect something with his property, precisely what seems to be uncertain. Mr. Vandenberg, who is now about sixty-five years old, and is a familiar figure to surface and underground railroad men, declares that his charter is good for ninety-nine years, and he proposes to put it on its legs again, if he can get capitalists to embark in the venture.

Randolph.

At Randolph a new street railway is in contemplation. T. L. Higgins, of Fredonia, can furnish information, plans, etc.

Schenectady.

The Broadway Surface Railroad case came up July 17, before Judge Landon, in Supreme Court Chambers, on motion of Attorney-General O'Brien to make permanent the temporary injunction restraining all others than Receiver John J. O'Brien from operating the Broadway Surface Railroad, receiving moneys from it, or bringing suit against it until the winding up of its affairs by the receiver. Attorney-General O'Brien appeared for the receiver, John J. Townsend for the city of New York, and William Bond, of Albany, for the minority of the stockholders, who desired to be made parties to the suit, in order that their interests might be protected. Mr. Townsend argued the motion for a change of venue from Albany to New York county. Attorney-General O'Brien opposed the motion. The decision of the motion was reserved.

Seneca Falls.

The Seneca Falls and Waterloo Railroad Co.'s extension to the Lake is progressing rapidly. A hotel is to be built at the Lake.

Syracuse.

The Woodlawn and Bitternut Street Railroad Co., of Syracuse, has been incorporated by Peter Kapesser and others. Capital, \$30,000.

Valatie.

A street railway is to be built between Valatie and Niverville. For particulars inquire of L. Sniffen, of Valatie.

OHIO.

Cincinnati.

A company proposes to build an elevated railroad in Cincinnati, and has applied for a charter. Incorporators: Eugene Zimmerman, M. E. Ingalls, Alexander McDonald, E. H. Huntington and Lawrence Maxwell.

Work has been commenced on the cable road trench at Fountain square, and is progressing at the Walnut Hills end of the line.

Cleveland.

The W. A. and W. S. S. R. R. will make a loop line from west side of Public square up Superior street to Erie, thence to Euclid, to point of starting. It will be built this fall. The loop will be of considerable value, as it will embrace the Post Office, Masonic Hall, Case Hall, City Hall, Cyclorama, Music Hall, Opera House, and many large business blocks.

The East Cleveland Street Railway Co. has now equipped all of its cars with the Haycox patent door fastener.

.

PENNSYLVANIA.

Philadelphia.

An electric motor was tested last week on a Philadelphia street railway with results apparently very satisfactory. Rapid speed was attained and the car was stopped and started with ease. The wires conducting the electric current are set in a conduit placed in the middle of the track and communicating through a slot with the car. The roadbed is a counterpart of that used with the cable system. Frames similar to the cable grip are used, carrying springs which rub against the iron portion of the conductors in the conduit, thus forming a good electric contact. The springs are connected to the terminals of the motor by insulated wires and the electric contact is produced by means of a lever. The same current which propels the car lights it, rings the electric bell and heats the car in winter. That cars can be propelled by electricity is not doubted. Can it be done as economically with other motive power, and is it reliable in all conditions of temperature and weather are the questions yet to be solved.

The Union Electric Company has been operating its experimental car on Ridge avenue, Philadelphia. A conduit 4½ inches by 9 inches contains the conductors, on which runs a traveler connecting with the motor on the car by wires. The comparative cost per day, including salaries, of horse and electric cars are estimated at \$4.74 and \$1.84 respectively.

The Traction Company, of Philadelphia, has introduced an electrical alarm system on its Market street line. The wires are laid in the conduit and can be operated from any manhole. It is to be used in the event of there being any accident to the cars.

Pittsburg.

The Brownsville Avenue Street Railroad Company of Pittsburg, will build a line from Carson street to the city line and thence to Knoxville. Horses or electric motors will be employed.

The East End and Wilksburg Electric Railway, in Pittsburg, is approaching completion.

Scranton.

The Scranton Suburban Railroad Company has been incorporated.

.

SOUTH CAROLINA.

Columbia.

A street railway is to be built in Columbia. A company has been incorporated by T. D. Gillespie and others, with a capital of \$50,000.

.

TEXAS.

Alvarado.

The Alvarado Street Railroad Company has commenced work on its line.

Gulf City.

The Gulf City Street Railroad Company of Galveston, has been refused an extension of time to complete its connections.

Waco.

The Waco Street Railway Company will extend its line two miles.

.

WISCONSIN.

Eau Claire.

At Eau Claire the street railway is to be extended. One extension is to be in the sixth ward on account of the rapid settlement of that district.

Neenah.

At Neenah work on the street railway has been delayed by the keeping of the rails at Bay View, owing to the strike. It is not yet decided whether the line will be run by electricity or horses.

Foreign Items.

LONDON, ENGLAND.—The line of the London Street Tramways Company from Holloway to King's Cross is about to be worked exclusively by compressed-air machinery instead of horses, as hitherto.

Underneath the car body is a series of cylindrical reservoirs, which may be charged with enough compressed air to propel it a distance of ten or twelve miles. The car is four wheeled, one pair of these wheels alone being used for driving, and, to save the expense and inconveniences of turn tables, the car may be driven from both ends. To the driving wheels are attached a pair of high and low pressure ordinary working cylinders, each of eight inches stroke. Means are provided by which the high-pressure air can be used in the low pressure cylinder, if necessary, for starting. The air in passing from the reservoirs to the cylinders bubbles through boiling water and steam of sixty pounds pressure on the square inch, contained in a vessel called the "hot pot," of which there is one at each end. This vessel is charged at the pumping station during the time occupied in charging the car with compressed air. The advantages claimed in thus using the air are that the heat which the air takes up in passing through the hot water not only causes the air to expand but prevents the formation of snow in the cylinders at the exhaust. The moisture also picked up by the air in its passage through the hot water acts as a lubricant for the side valves and pistons.

The working pressure in the high-pressure cylinder can be varied at will; it is usually from 120 pounds down to fifty pounds on the square inch, the variation being regulated by a valve of peculiar construction, consisting essentially of a piston, which, by means of a hand wheel and screw, can be forced into or raised from a vessel in which water and air are contained. The bottom of this vessel is made of an India rubber diaphragm, which is connected to a valve opening against the pressure of steam and air in the "hot pot." With this arrangement, when the piston is forced down into the vessel in which the water is contained, the diaphragm is pressed downward and the valve is opened, allowing the steam and air to escape from the "hot pot" to the working cylinder. This valve gives the driver a most delicate and beautiful means of varying the working pressure, which, in addition, it automatically regulates. Every precaution has been taken for safety. In the first place the car can run over nobody. The wheels are hidden from view behind the capacious cylindrical reservoirs which flank all four sides almost down to the road level. Whatever may get in the way of the car in motion would simply be shunted aside, albeit somewhat unceremoniously. But the car can be pulled up short; the brakes can be applied to all four wheels in any one of three different ways. In the case of excessive speed, as over ten miles an hour, there is a governor which not only cuts off all steam, or rather the air, from the engines working the car, but applies the brakes. The driver, too, can, from either end of the car, put on the air-pressure brake, and has a foot brake continually under his control when the car is in motion, with which ordinary passenger stops are made. With the most powerful of these arrangements, and when running at its greatest speed and in ordinary weather, the car can be brought to rest in a distance slightly exceeding its own length. The driver also has the power, by reversing the engines, of rapidly coming to a standstill. The car as constructed carries thirty-eight passengers and weighs about six and one-half tons unloaded. The tramway is regarded as one of the most difficult for the purpose on account of its varied gradients and a sharp curve in its course, not to mention the fact that the thoroughfare is one of the busiest in London.—*Railway and Tramway Express.*

AUSTRALIA.

Melbourne.—Twenty-six miles of cable road are to be built here, and the Government has guaranteed 4 per cent. interest on the bonds, which are taken by a London banker, Messrs. Roebling, of New York City, and Trenton,

N. J., have the contract for 280,000 feet of wire rope, and the cars will also probably be built in this country.

CANADA.

Montreal.—The Montreal Street-Railroad Company is building several extensions. Suitable horses are now offering at \$130 to \$180.

Toronto.—The city corporation has brought an act to compel the street railroad company to put conductors on the one-horse cars in compliance with the by-law of 1882. The company contend that the by-law is unreasonable, and has secured an extension of time for its defence, in order to procure evidence from the United States.

MEXICO.

Pachuca.—A contract between the Governor of the State of Hidalgo and Luis Garcia Otamerdi has been sent to the Legislature. It provides for the construction of two street railroads from the haciendas of Purisima Grande and Coscotillan to the depot of the Hidalgo Railroad.

ITALY.

Monte Della Guardia.—A plan for a cable railway on Monte Della Guardia, situated 6¼ miles from Genoa, has lately been projected. This will afford a great accommodation to upwards of 60,000 persons who annually visit the sanctuary of the Madonna della Guardia, located at an altitude of 2,656 feet on this mountain. The line will be 3½ miles long and will cost about \$300,000.

Notes.

The Baltimore and Hampton Electric Railway, which was described and illustrated in the last issue of the GAZETTE (see page 201) was constructed by the Safety Electric Power Company (Daft system) 41 and 43 Wall street, New York.

The Woodland Avenue and West Side Street Railway Company of Cleveland, are building four box cars for use on Woodlawn, Pearl, and Lorain Division.

BLACKPOOL ELECTRIC TRAMWAY.—The audit of the books shows, for the half year ending with May, that the working expenses are only half that of horses on the most economically worked lines, even allowing ten per cent. for interest on capital and fifteen per cent. for depreciation, because all the generating plant is duplicated. If the electrical working of the Blackpool tramway be compared with the working by horses before the electrical plant was ready, it will be found to cost only twenty-five per cent. of the latter.

PUGH & RUSSELL, the well-known supply men, have perfected arrangements with Mr. W. E. Haycox, to handle his patent door fastener.

RECENT SALES OF THE PULLMAN COMPANY.—To the Chicago City Passenger Ry. Co., twenty-five 16-foot cars of the improved railway style, with Bemis patent gear, Vose springs, and are the late Pullman improvement, with special large mirrors in each end in place of the usual slat blind, etc.

Wichita (Kas.) City Ry. Co., two 12-foot cars. Scranton (Pa.) Peoples' St. Ry. Co., four 16-foot railway style, to be used with the Vandepole electric motor, cars to be lighted, and signal bell operated by same system.

Mt. Adams & Eden Park Ry., Cincinnati, Ohio, twenty 16-foot cars with clear front platform for grip.

Highland Park W. R., Detroit, two 14-foot electric motors, built by Detroit Electrical Works, motor in center of each car to occupy space of 24 inches square.

THE LEVINS AND FOWLER MFG. CO., are now fully settled in their new quarters, at 27 to 35 Walworth Street. Their new machinery and present facilities allow them to completely equip a railroad.

THE Patent Sash Holder which we illustrate in this issue, is manufactured by the Ayers' Patent Sash Holder Company of New York.

The Street Railway Gazette.

VOL. I.

CHICAGO

SEPTEMBER, 1886.

NEW YORK

No. 9.

William H. Paine.

William H. Paine is a native of Chester, New Hampshire, and is fifty-eight years of age. He is a descendant of one of the oldest New England families. In boyhood he secured a good academic education, followed by a course in engineering. His attention was then given to land surveying, and his early experience was gained in the wilds of northern Wisconsin, and in the great gold fields of California. In 1853, he surveyed a route for a Pacific railway, across the Nevada mountains from Sacramento to Utah, and was fully engaged in important work of this character till the Rebellion broke out in 1861, when he at once responded to the call to arms, and assisted in raising several Wisconsin regiments. His services in the army were remarkable for enterprise, bravery, and observations, and for obtaining information and securing a knowledge, which his scientific and studious mind allowed him to utilize in a valuable manner. For instance, he ascertained the exact length and dimensions of all the railway bridges from Washington to Richmond. His measurements and plans were invaluable to the government. His promotion was deservedly rapid. He was staff engineer to General Meade, when in command of the Army of the Potomac, and of General McDowell and others. Such a position, for one who was not a graduate of the West Point Military Academy, was unique in army history. His promotion was won by sheer merit.

Our space will not allow us to give, however much we might wish to do so, fuller records of his military services, which were full of incidents, ingenuity, and scientific ability; these have already been published and read with interest. We pass on to the time when he returned to civil engineering. In 1867-68, he was engaged in building the North Side Railroad on Long Island. In 1869 he was chosen as one of the engineers upon the New York and Brooklyn Bridge. His record since then forms part of that of the bridge; he labored diligently and steadily in the work, and with the most gratifying results. He assisted in making the original surveys; superintended the building, placing, and sinking of the caissons; built the New York tower; oversaw the placing of the cable wires; was in charge of

the laying of the superstructure, and planned the system of cable traction, by which the cars are run across the bridge. The regulating of the cables, admitted by all to be a difficult undertaking, was accomplished in a masterly manner. The knowledge of these valuable services, gave the trustees great gratification and satisfaction. He also attended to the testing of the steel wire in the cables, and of all the steel used in the superstructure, and originated the idea of using straight wire in the construction of cables, which ensures greater strength and durability. Colonel Paine needs no eulogium from us. He is known as a practical, skillful and talented engineer, with an intimate knowl-

edge of the science of chemistry, geology, topography, and of both civil and mechanical engineering. He was Vice President of the American Society of Civil Engineers for several years in succession, and now holds the position of chief engineer on the cable road, Tenth avenue and 128th street, New York.

Much of his early engineering was done where journals and books on engineering were beyond his reach, and where he had no opportunity to consult with other engineers. This experience gave him the habit of depending upon his own resources, and of working out practical problems by methods of his own. The results of his early experiments in California assisted to raise the methods of placer mining, from the cradle to the giant hydraulic operations which followed. The lack of suitable instruments led him to improvise others; he used a wire with handles attached, to measure across the Nevada Mountains; this

he improved upon by using a flat steel tape, to which, still later, he added attachments for compensating for the effects of changes of temperature; also other accessories for securing greater accuracy and facility of use. The steel tape lines now in so common use were his invention.

His attention to the subject of lineal measures, led still farther to the construction of one so accurate, and so arranged and adapted, as to be capable of indicating the change in length of bridge members to the one millionth part of five feet, with similar accuracy for other lengths, by means of which it is practicable to determine the effect of passing loads, and ascertaining whether the material retains its integrity. Thus it was that the cables of the Niagara



W. H. Paine

R. R. Suspension Bridge were restored to the confidence of those who had withdrawn their trains from this bridge, through fear of the cables having deteriorated. Other less important bridges have been tested in a similar manner.

Colonel Paine's ability to devise means to accomplish desired ends, has rendered his services almost invaluable in the various fields of engineering in which he has been employed. The construction of cable railroads, has occupied his attention for years past, and gives him an opportunity of inventing and improving, which he has embraced and followed with such success, that the cable road over the New York and Brooklyn bridge, and the 10th avenue and 125th street cable road, of which he is now chief engineer, are among the most successful in the country.

Street Railway Patents.

- No. 344,108—Car Motor. J. B. Huston, Cleveland, O.
 No. 344,128—Horse Shoe. E. A. Monroe, Saratoga Springs, N. Y.
 No. 344,287—Fare Box. W. G. Price, Scheneyus, N. Y.
 No. 345,616—Cable Railway. Preston M. Bruner, St. Louis, Mo.
 No. 345,495—Cable Grip. John S. Forbes, Philadelphia, Pa.
 No. 345,458—Car Axle Box. James Timms, Columbus, Ohio.
 No. 345,281—Car Starter. Ezra Dederick, Milwaukee, Wis.

No. 346,963—Automatic Suspended Switching Device for Electric Railways. Charles J. Vandepoele, Chicago, Ill. The invention relates to improvements in electric railways of the class in which a suspended conductor and a traveling contact dragged therealong by the car, and having branch tracks or switches, form essential features; and it consists in such construction of the traveling contact and arrangement of the switch so that the said carriage will be automatically controlled and directed in its course along the conductors in a prearranged manner.

No. 346,912—Splice for Underground Cables. William R. Patterson, Chicago, Ill., assignor to the Western Electric Company of same place. Relates to an improvement upon his patent 277,335, of May 8, 1883.

No. 346,902—Pneumatic and Electric Railway. Ellis F. Edgar, Woodbridge, N. J. In an air-tight tunnel is provided a series of electrical tracks for automatically starting and stopping trains.

Electric Motor. C. Doriot, Philadelphia, Pa.

Fare Box. W. T. Dryden, Memphis, Tenn.

Horse Shoe. L. B. Melius, New York, N. Y.

Rail Bender. A. A. Strom, Chicago, Ill.

Horse Shoers' Knife. Jean Bernadac, New Iberia, La.

Hoof Trimming Device. Jean Bernadac, New Iberia, La.

ENGLISH PATENT.

Tramcar Life Guards and Groove Cleaners. W. C. Edwards and J. Record, London. This invention relates to frames for carrying life guards in such a manner that the bottom edges of the life guards at both ends of the car are always at the same distance from the track whether the car be loaded or not. Four claims are made for the construction and arrangement of parts. No. 12,641.

THE Montgomery, Ala., street railway is working very nicely. The following little episode is reported by the local *Dispatch*: An old dorky, speaking to a younger "ward of the nation" about electric street cars yesterday, said: "Huh, boy, you see how dese white folks dun took away dem mules' job from 'em? Well, dat's de way dey is gwine to do de poor dorky. Fust thing you know dey'll hab a plow what'll run rite along widout any nigger; and ef dey don't do dat dey'll get some kinder seed what'll grow widout any cultivation. Dese white folks is powerful smart, dey is."

NEVER keep your seat and allow your mother to stand. If it is some one else's mother it does not so much matter.

Construction, Equipment and Maintenance of American Street Railways.

BY AUGUSTINE W. WRIGHT.

(Continued from page 224.)

SWEEPERS.

Figure No. 37 shows a sweeper manufactured by the Brooklyn, N. Y., Supply Co. Two sizes are made. The North Chicago City Railway have had one of their large sweepers, operated by ten horses, and five smaller sweepers operated by eight horses, in use for several years. They

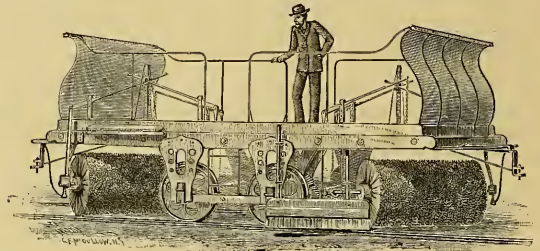

Fig. 37

are well built. Frames are of well seasoned white oak. Floor of matched yellow pine. Sills 4x10 inches. The platform is 16 feet 6 inches long, enclosed on the sides by a round iron railing. The dash board at either end is of boiler iron, well braced, and curved to graceful proportions similar to a "cutter." An iron ladder is provided on each side to mount upon the platform, which is 3 feet 10 inches above the track grade. The wheels are 30 inches in diameter. Axles $3\frac{1}{4}$ inches diameter with journals $2\frac{3}{4} \times 5$ inches. Near one end of the axle a strong bevel gear is keyed, and motion is transmitted from it to the brooms by a pinion proportioned two to one. This pinion is hung in a square shaft with bearings running in a frame bolted to the oak framing. Arrangements are provided so that the pinion remains in mesh with the gear whether the frame be raised or lowered. A toggle joint permits irregular motion of either broom or pinion. The outer end of the broom shaft is carried by an improved journal box which can slide up and down on a vertical shaft shown on the side of the car. It is operated by means of levers, coupled together at the center, so that both ends of the brooms are lifted to the same extent and at the same time, causing equal wear. The broom when new can be lifted several inches clear of the track and depressed until only six inches of the rattan is left.

The brooms are made of white oak; four pieces are cut to a bevel and then turned to an outside diameter of nine inches. They are retained in position by hoops of iron, and are drilled to receive twenty-four rows of rattan canes, which are bent in at one hole and out at the next. They are held tightly in place by a filling. When new the outside diameter of the rattan is 38 inches. The brooms rotate in opposite directions. As before mentioned they are geared two to one so that if the horses proceed at a velocity of six miles per hour the broom rotates at twelve miles per hour. The speed at which they revolve throws gravel, snow or mud outwards with considerable force and it has been found necessary to enclose the sweepers with stout canvas curtains. One broom would not clean both rails, so two brooms at an angle of 45 degrees are provided, and a leveling broom is also placed outside at each end.

The smaller sized sweeper is estimated to weigh about two and a quarter tons, but the actual weight has not been taken of either sweeper, owing to the difficulty of getting them upon scales. The price of either size is about \$1,000 delivered in any city; but this price may be reduced in the future.

The wheels should have deep and strong flanges and run upon them, for the snow reduces the adhesion between the head of rail and tread of wheel, so that the latter will slide before the brooms will revolve, should the bearing be taken between the wheel tread and rail head.

I use eight horses for the small sweeper and ten for the large sweeper, with four men.

Fig. 38 shows the sweeper manufactured by F. H. Clooney, of New York.

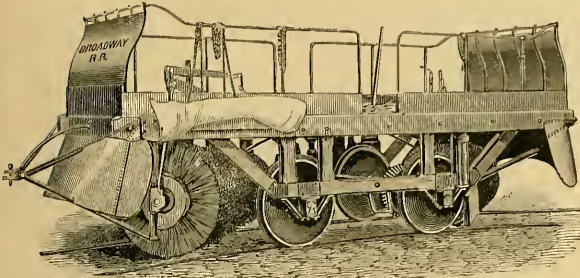

Fig. 38

The advantages they possess over sweeping the tracks by hand are as follows:

1st. Cheapness. The cost of sweeping a track with such a machine, I have found in practice, to have been only 25 per cent. of the cost by hand power.

2d. The tracks can be cleared of snow in a fraction of the time required for hand power, even if the men can be secured to brave the storm night or day, at short notice.

This is a decided advantage, but difficult to value in dollars and cents. It enables a company to keep its road open, accommodate its patrons, save its horse flesh!!

On the other hand the pavement is swept so clean that it is more slippery than if some snow had been left upon it. This necessitates the expense of "sanding" the track each time that it may have been swept, to afford the horses a secure foothold, especially upon pavements other than cobble.

Removing the snow so clean from the pavement allows the frost to penetrate deeper than it otherwise would, thus affecting the stability of the pavement.

"Snow protects the soil in winter from the effects of cold, in the same way that fur and wool protect animals, and clothing, man. Snow is made up of an infinite number of little crystals, which retain among their interstices a large amount of air, and thus contribute to render it a non-conductor of heat.

A covering of snow also prevents the earth from throwing off its heat by radiation. The temperature of the earth, therefore, when covered with snow, rarely descends much below the freezing point, even when the air is fifteen or twenty degrees colder." The moisture from the snow is beneficial to the horses' hoofs. Without moisture they get hard and brittle.

It has seemed to me that the pavements have not been as stable since sweepers have been used as they were before. The gravel is swept out from among the interstices in cobble stone pavements. When a thaw melts the snow along side the tracks, the resulting water flows into them; or perhaps rain falls, followed in either case by a freeze. The gravel having been removed from among the interstices of the cobble, the water is more apt to penetrate and soak in beneath the stones, ruining the foundation and permitting unequal settlement. The freeze that follows raises the stones, and more extensive repairs are required. All these disadvantages should be charged against sweeping machines.

Their wheels should be made with deep flanges, as above remarked, otherwise they will have to be heavily loaded to cause the wheels to revolve, for the adhesion between the rail, covered with snow or ice, and the wheel is much lessened. The brooms are connected by gearing to the axle of the wheels, and if the latter do not turn, the broom cannot, and the snow is not removed from the track.

In my opinion, a better arrangement is to use a light, four horse sweeper behind a four horse snow plow. The sweeper could then be employed advantageously in summer to remove the mud and dirt, when it would not pay to run an eight or ten horse sweeper.

As the sweeper frightens horses along the line of the road, I always have men to accompany the sweeper, to hold such horses as appear uneasy and are without drivers.

In the severe cold of a Chicago storm, the thermometer at times sinking 25 or 30 degrees below zero, not a little trouble was experienced from the freezing of the rattan composing the brooms. This made them so brittle that they broke like pipe stems. Mr. John Miller, M. M. of the North Chicago R'y, found that soaking the rattan in kerosene oil effectually prevented their freezing, and this is now always done with our sweepers.

After having been used they are put in a warm room to "thaw out," and then thoroughly cleaned, when they are ready for the next snow storm.

SALTERS.

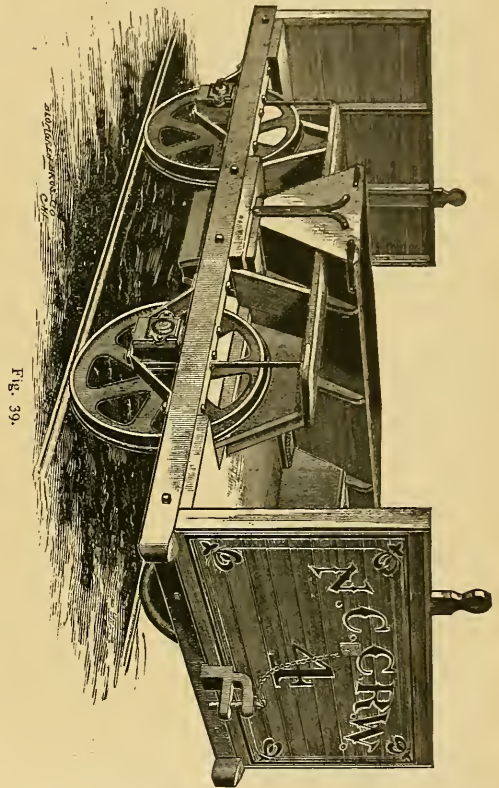

Fig. 39.

Fig. No. 39 shows the machine used by the North Chicago R'y. in salting its tracks. The frame is 11 feet long by 6 feet 1 inch wide. The floor is 25 inches above the track. It has a wooden dash at each end 2 feet 7 inches high and 6 feet 1 inch wide. Sills are of oak 4 inches wide and 5 inches deep. It is mounted upon four wheels 30 inches in diameter, covered as shown in the drawing.

The hopper for salt is 5 inches wide at its bottom and flares to 25 inches wide at its top, 19 inches high—all inside measurements. Over each track rail there is an opening in the bottom of the hopper 3x4 inches, with an iron sliding cover, moved by a lever on the outside, so that this opening and consequently the amount of salt dropped on the rail can be regulated at pleasure. Ten barrels of salt can

be stood on the salter, and three put in the hopper. The amount of salt used upon the trip, varies with the snow fall, etc. As an average I should say the North Chicago R'y Co. use about one bushel of salt per mile of single track, and in my opinion it is not only not injurious to the horses, but a great benefit by lessening the amount of force they must exert in propelling the street car.

The use of salt upon the tracks of the street railways has awakened much discussion *pro* and *con*. Legislatures have enacted laws prohibiting its use, as detrimental to public health, but eminent physicians have expressed an opinion quite the reverse.

The special committee on "Track cleaning and the removal of snow and ice," reported to the Am. Street R'y Association, October, 1884, "that they had addressed a circular letter to the presidents and superintendents of all the street railways in America, comprising a full series of questions in relation to the propriety of the use of salt in the cleaning of the tracks from snow and ice, and whether any better method could be suggested. The inquiry was very explicit, being intended for an exhaustive consideration of the subject. Almost every individual addressed replied, making a vast accumulation of evidence bearing directly upon the subject. The conclusions appear to be decidedly in favor of the free use of salt, even to a greater extent than is anywhere practiced." A. B. Whitney, M. D., was chairman of this committee, whose conclusions were:

"The committee find that the use of salt for the removal of snow and ice from the railway track to be an imperative necessity, and that there exists no reasonable cause for apprehension of injury or detriment to the public health, or to the health or physical comfort of the animals employed. * * * It is in every way advantageous, and to this conclusion the good sense of our people must eventually arrive."

The report of the third annual meeting of the Am. Street R'y Association contains much valuable matter bearing upon this question, and enough to convince any impartial mind that this use of salt is advantageous.

Horses in Chicago are stood in a bath of salt water stronger than the brine upon the street caused by melting snow and ice with salt, because the effect is considered beneficial to their hoofs.

The testimony of street railway officials at the convention was almost unanimously in favor of the use of salt.

(To be continued.)

Cable Railway Propulsion.

BY W. W. HANSCOM, M.E., M. TECH. SOC.

[Copyrighted by the Author.]
(Continued from page 228.)

In the construction of the driving machinery, some basis for consideration may be had by a comparison of the weights of the moving machinery for the roads in this city, when they are each compared with the weight of the cables which they propel and support. It may be taken for granted that the weight of supports and foundations for the moving machinery will be proportionate to the weight they have to carry.

The weights of moving machinery include the moving parts of the engines, shafts, fly wheels, pulleys, sheaves and gears in the engine house; also, the deflecting sheaves, which change the direction of the moving cable, and the carrier sheaves, which support the cable in the tube along the street.

The approximate weights of moving machinery and cables on the various roads of San Francisco are as follows:

| Name of Road. | Weight of Machinery, pounds. | Weight of Cable, pounds. |
|----------------------------------|------------------------------|--------------------------|
| Clay..... | 22,000 | 15,400 |
| California..... | 100,000 | 65,000 |
| Sutter..... | 240,000 | 68,000 |
| Geary..... | 60,000 | 37,800 |
| Union..... | 80,000 | 30,500 |
| Market, Valencia and Haight..... | 240,000 | 104,412 |
| McAllister..... | 100,000 | 68,000 |

To compare the weight of moving machinery with the weight of cable, let the weight of cable be 1, then the weight of moving machinery will show as follows;

| Name of Road. | Weight of Rope. = 1. | Weight of Machinery. |
|----------------------------------|-------------------------|----------------------|
| Clay..... | 1 | 1.428 |
| Market, Valencia and Haight..... | 1 | 1.459 |
| McAllister..... | 1 | 1.47 |
| California..... | 1 | 1.538 |
| Geary..... | 1 | 1.587 |
| Union..... | 1 | 2.622 |
| Sutter..... | 1 | 3.529 |

These figures are somewhat suggestive. As the cost of machinery of this character is generally sold in the market by the pound, it is comparatively easy to estimate the cost of the driving machinery, and as the cost will be generally in proportion to the weight, due consideration should be given to this division of the construction account.

In the construction of the gripping apparatus there are several considerations which have much influence on the cost: First, is the work which they are required to do; second, the conditions under which this work has to be performed; and third, the promptness with which they can be manipulated. In referring to the first condition, the work which the grip has to perform depends to a large extent on the grades over which they have to act. Allowing 20 pounds per ton for the friction of cars, then a grade of one in one hundred, or one per cent., doubles the strain on the grip. The steepest grade on the roads of this city requires as much power to be developed by the engine in hauling one train over it as would be required to haul eighteen trains on a level.

While the amount of work put on the grip calls for strength and power, the requirements of passengers and care for human life necessitate a construction which will admit of prompt action, and this is a very important feature in their construction.

There may be conditions existing under which it would be greater economy for the grip to break than to withstand the strain to which it is liable to be exposed, but as a general proposition it is a fallacy to assume anything of the kind. It is a condition of things which should not occur, and will not, with competent engineering ability.

The first consideration is to construct the grip to meet the actual requirements as to work, promptness, ordinary wear and convenience in handling.

In the construction of the cable much has yet to be learned. The principal condition is that it shall be sufficiently strong, after considerable wear, to withstand probable extraordinary strains; at the same time it shall not be unduly large, which adds to the weight and cost. Having an exterior surface, which is hard, so as to withstand the abrasion of the jaws of the grip, yet the flexibility of the cable shall be of such a degree that it will easily bend in passing over the sheaves and drums which will change its direction.

The greater the diameter of the cable the more friction and abrasion, and power required to bend it around the sheaves which it passes. Various kinds of cables have been used on these roads—both of iron and steel, and large and small—and with various degrees of hardness. So far, the crucible steel cable has been adopted in preference to any other, possessing hardness and strength, with flexibility. It is probable that changes in the lay or twist of the strands in making may effect an improvement in working.

In the construction of cars there is at present but little difference, in general views. Whether a dummy and car should be used together, or each car have a grip attached to it, is a question which will be answered differently by different local conditions, a prominent condition being all intelligent provisions for the safety of passengers in boarding and alighting from. As the larger part of accidents on these roads occur by the negligence of the injured, all means consistent with convenient access to and depart-

ure from the cars and dummies should be provided to prevent accidents.

In the maintenance of road-bed and tube, the present method of uniting concrete and iron leaves not much to be desired, the rails and the paving being the only parts that require renewals during many years. The rails and slot irons should be so put down that they may be taken up and renewed without detriment to the tube or unnecessary disturbance of the materials of which the tube is constructed.

Concerning driving gear and the moving machinery connected with the cable, the engines which may be used are so well known that any style, kind, or power may be obtained to meet any condition which would arise under local circumstances. In the various arrangements for carrying and deflecting the cables we have some differences in detail, but in plan all are similar. This is a matter that has not received the consideration that its importance demands. As a large portion of the power expended is exhausted in wearing out the driving machinery and carrying and deflecting sheaves, these should have careful study that they may do the work assigned them with the greatest economy of wear and friction.

The first table shows the comparative weights of driving and carrying machinery and the cables which they carry. For the maintenance the cost may not always be in proportion to the weight, but the more weighty it is made the more is the wear and the more attendance and lubrication is required, as well as the increased cost of construction.

The third division under maintenance is the gripping apparatus and cables. These are mutually dependent one on the other. In the grip the wear comes on the jaws which clasp the cable, and these are now made removable, so that they can be made of the least possible weight and easily renewed, they being composed of soft cast-iron, that having with the experience so far proved the most economical of any material yet used. As the contact or connection between the grip and rope is entirely one of friction, it becomes a question of how great an abrasion or wear of the jaws of the grip can be allowed in saving the wear of the cable without costing more than the wear of the latter.

When cables are newly laid they cause a much more rapid wear of the jaws of the grip than after they have been in use some time. The cause is that when new the exterior wires composing the cable are comparatively sharp cutting edges, but they are gradually worn down or flattened by the action of the grip jaws upon them, and, in addition, a coating of tar is put on the cable, which fills up the interstices, and by frequent applications the surface of the cable becomes so smooth as to resemble a bar of iron in passing rapidly along. This condition reduces the wear of the jaws and their life is increased from 200 to 400 per cent., and even more. There are two advantages in this filling of the cable with tar, one of which is to lubricate the cable to a certain extent, so that when taking hold to start a train the slip of the cable through the grip causes the train to start more gently and at the same time lessens the wear on both grip jaws and cable. The tar alone on the cable would not effect this purpose, but by the addition of a small quantity of oil the surface of the tar is prevented from adhering to the grip or to the sheaves over which it passes. The maintenance of the cable is one of the great expenses in the operation of cable roads, or rather it has been, from several causes, first of which is the excessive wear or action upon it by the jaws of the grip, especially when a road is first built and new men have to learn the road and get experience in the handling of the grip in starting and stopping. Whatever kind of cable may be used the abrasion may be increased very largely by this action of the grip, and the experience with cables in this city has demonstrated that the life of a cable may be doubled nearly by the manner of applying the grip to the rope.

Another cause is the construction of the grip for relieving the cable from frictional contact when the car or train

is standing still and the cable allowed to pass through the grip. The grips are usually so constructed that the cable is supported and guided by grooved rolls when the jaws are loosened, the rolls keeping the cable from coming in contact with the jaws. Some of them, those called "side" grips, support the cable by rolls under the cable, the jaws having a vertical movement.

The rolls being stationary, so far as vertical movement is concerned, when it is desired to start the car, the upper jaw is forced downward on to the lower jaw. In one grip in use in this city, the upper jaw extends over the friction rolls, so that the cable is forced against the rolls, and the lower jaw being shorter than the upper in this case, the lower jaw has to be at such a height that the cable will be compressed between it and the upper jaw as well as between the upper jaw and the friction rolls, so that the cable must lie partially on the lower jaw, whether compressed or when moving freely through the grip. Another grip, the rolls are placed so far apart that both upper and lower jaws are considerably shorter than the distance between the friction rolls, and the upper jaw in being forced down on to the lower jaw, carries the cable with it, and when raised, the cable travels entirely on the rolls, being free from the lower jaw. In the grip in use on the Geary street road, the grip opens at the bottom, and not having any friction rolls, the cable lies and moves on the jaws of the grip when the cars are standing still. On roads where frequent stops are made, the wear of the cable increases. Other things being equal, the wear of the cable will be in proportion to the number of stops made, and its life inversely.

So far, the greatest factor in the destruction of the cable is the grip, and experience shows that skill in operating it adds to the life, and consequently economy of maintenance of the cable. The length of the jaw, which embraces the cable, is not known yet to affect the life much, but it seems that a jaw having a length of 8 to 10 diameters of the cable, is sufficient to prevent any pressure from bruising the cable and at the same time will hold any load that has yet been taken up the steepest grades in this city. The practical requirements for economy of maintenance of cable, are that the grip shall be so constructed that friction rolls shall support the cable free from the jaws when it is passing through them and the frictional contact shall be between the jaws entirely when propelling a car; that the operator of the grip shall be a man of intelligence, who can apply the grip to start the car quietly, and have the least amount of slip of the cable through the jaws. It does not follow that the one who starts the car the easiest or most gently, will wear out the jaws the soonest. Experience has proved the contrary. Lastly, continuous care of the cable, in keeping it well filled with tar and properly oiled.

Under the head of operation, I have placed the power required to propel—1st, the cable; 2d, the cars; and 3d, the passengers. In order that a comparison may be made, I have taken indicator diagrams from the roads in San Francisco, and the table herewith shows the amount required for driving the cable alone—I mean by this, without any cars being on the road; but included is the friction of the engines and driving machinery; also the friction of the carrying and deflecting sheaves, as well as the power consumed in bending the cable around the sheaves. I have not attempted to segregate the power required for driving the cable from that required to move the engines and driving machinery without the cable on, because all this power is in constant use, is a constant expense, and the fuel expense for driving a certain amount of cable at a certain speed, depends upon the ability of the constructing engineer to design, and a proper direction of the labor having the care of it when in operation. For the purposes of this paper, I have reduced the work done on the various roads, to the number of pounds of cable moved one mile per hour with one horse power.

In the following table the power for moving the cables of Sutter and Geary streets are estimated by taking the average of the work done on the Clay, California and Union street roads.

| NAME OF ROAD. | Horse power to drive cable. | Pounds of cable moved 1 mile per hour with 1 horse power. | Proportionate power required for driving cable, Clay St. being 1. |
|------------------------|-----------------------------|---|---|
| Clay | 22.6 | 4,084 | 1.00 |
| Sutter, estimate | 83.6 | 4,538 | .90 |
| Geary, estimate | 58.0 | 4,538 | .90 |
| California | 84.0 | 4,743 | .861 |
| Union | 39.0 | 4,788 | .852 |
| Market | 201.0 | 6,221 | .656 |
| McAllister | 60.0 | 9,066 | .45 |

For the power to haul the cars I have allowed 20 pounds per ton at all speeds. This would give for the various roads an approximate power for each train, consisting of dummy and car, and on Market and McAllister, for the car alone :

| NAME OF ROAD. | W't of Car and Dummy. | Horse Power for each Car. | Average No. of Cars. | Total Average Power for Cars. |
|-----------------------|-----------------------|---------------------------|----------------------|-------------------------------|
| Clay | 4,900 | .80 | 7 | 5.60 |
| Sutter | 7,500 | 1.50 | 18 | 27.00 |
| California | 8,600 | 1.40 | 14 | 19.60 |
| Geary | 8,400 | 1.94 | 19 | 36.86 |
| Union | 8,600 | 1.42 | 10 | 14.20 |
| Market & Haight | 9,600 | 2.07 | 44 | 91.00 |
| McAllister | 9,600 | 2.07 | 18 | 37.00 |

The following table gives the approximate average speed of each road, the average distance that passengers are carried, the total number running hours each day, and the average horse power required to haul 1,000 passengers on each road :

| NAME OF ROAD. | Average Speed. | Average Dist'ce that Passengers are carried, Miles. | Total hours Running Time each day. | Average Power for each 1000 passengers Car'd. Horse Power. |
|------------------|----------------|---|------------------------------------|--|
| Clay | 6 | 1/2 | 17 1/2 | .0971 |
| Sutter | 7 1/2 | 1 1/2 | 19 1/2 | .261 |
| California | 6 | 1 | 19 | .178 |
| Geary | 7 3/4 | 1 | 19 | .177 |
| Union | 6 | 1 | 17 1/2 | .194 |
| Market | 8 | 2 1/2 | 20 3/4 | .412 |
| McAllister | 8 | 1 | 20 3/4 | .163 |

This table shows that the power required to convey passengers by themselves is a small factor of the total power required in operating cable roads. It is assumed here that the average distance which each passenger is carried will be about half the length of the road.

The following table will give the total daily average power for operating the cable roads in this city, and also the per cent. of power required for moving cable, for moving cars, and (assuming numbers) for moving passengers :

| NAME OF ROAD. | Total Pow'r | For Cable. | | For Cars. | | For Passengers. | | No. of Passengers. |
|------------------------|-------------|------------|---------|-----------|---------|-----------------|---------|--------------------|
| | | Power. | Per ct. | Power. | Per ct. | Power. | Per ct. | |
| Clay | 28.56 | 22.6 | 79.0 | 5.60 | 19.0 | .36 | 2.0 | 4,000 |
| Sutter, estimate | 114.60 | 83.6 | 72.9 | 27.00 | 23.5 | 4.00 | 3.6 | 15,000 |
| California | 105.02 | 84.0 | 80.0 | 19.60 | 18.6 | 1.42 | 1.4 | 8,000 |
| Geary | 96.03 | 58.0 | 60.0 | 36.86 | 38.0 | 1.77 | 2.0 | 10,000 |
| Union | 54.55 | 39.0 | 70.0 | 14.20 | 26.0 | 1.35 | 4.0 | 7,000 |
| Market | 301.00 | 201.0 | 65.7 | 91.00 | 30.6 | 9.00 | 2.7 | 22,500 |
| McAllister | 98.39 | 60.0 | 61.0 | 37.00 | 37.6 | 1.30 | 1.4 | 8,000 |
| | 798.66 | 548.2 | 68.0 | 231.26 | 28.0 | 19.26 | 4.0 | 74,000 |

These results are the average percentages for estimated average number of cars and passengers. The following table gives the average number of feet of cable for each car, except Market street, to which should be added the cars which are switched from the McAllister street road. This table shows the average distance apart of cars to be 1,716 feet for average running, but on holidays and Sundays these distances have been reduced about 45 per cent., so that cars have run 1,000 feet apart, average. I am aware that in some instances they have run much less distance than this, but at eight miles per hour the speed would be 704 feet per minute, or an interval of about 1 1/2 minute between cars, allowing for stops.

| NAME OF ROAD. | Number of Cars. | Feet of Cable. | Feet of Cable to each Car. |
|------------------|-----------------|----------------|----------------------------|
| Clay | 7 | 11,000 | 1,571 |
| Sutter | 18 | 37,736 | 2,096 |
| California | 14 | 25,895 | 1,844 |
| Geary | 19 | 27,000 | 1,421 |
| Union | 10 | 21,000 | 2,100 |
| Market | 44 | 65,765 | 1,472 |
| McAllister | 18 | 27,183 | 1,510 |
| | 130 | 215,579 | 12,014 |
| Average | 18.5 | 30,797 | 1,716 |

Of course, if traffic demanded it, this number of cars could be kept on the road. That would be one car to each 1,000 feet of rope, and taking the totals from table above, there would be added 85 cars; and if each car carried the average number of passengers, they would be increased 48,000, or 65 per cent., so that 65 per cent. would be added to the power required for hauling the cars, which would be $231.26 + 150.31 = 381.57$ for cars, and 65 per cent. for passengers would be $19.26 + 12.51 = 31.77$ horse power. Then the total power would be

| | |
|----------------------|--------|
| For cables | 548.2 |
| For cars | 381.57 |
| For passengers | 31.77 |
| | 961.56 |

Of which 57 per cent. would be for cable
 39 " " " cars
 and 4 " " " passengers.
 100

This is taking the average of all the roads, but if we take the road which has the least per cent. of power expended in moving the cable, the Geary street, and add cars so that they may be only 1,000 feet apart, we shall have 8 more cars—an increase of 42 per cent, and also an increase of 42 in the total power for hauling cars and passengers, thus :

| | | |
|-----------------------------|-------|-------|
| For moving cable | 58 | H. P. |
| For moving cars | 52.34 | " |
| For moving passengers | 2.84 | " |

Total H. P.

| | |
|--|--------|
| Of which 51 per cent. would be for moving cable. | 113.18 |
| 46 " " " cars. | |
| and 3 " " " passengers. | |
| 100 | |

This is within the capacity of the road as in this case assumed, carried 14,200 passengers; while it has actually many times carried from 20,000 to 22,000 passengers in one day.

Therefore we may conclude that it is practicable to utilize 50 per cent. of the total power expended in moving the cars and passengers. That this is much within bounds will be admitted when it is seen that the comparative power expended in moving the Geary street cable is .90, and that of McAllister street is only .45, or one half.

There is one other point which I will refer to, and that is the comparative power required over grades or level roads. While the average will remain about the same, the fluctuations will be much greater and the consequent maximum strain on the cable will be greater over grades, and this variation of work calls for an engine that will keep a uniform speed under more severe conditions than usually obtain even in rolling mills, for if the speed of the engine in the mills varies somewhat human comfort is not affected by it; but in cars moved by cable, any variation in the speed of the engine may be easily detected by the surging movement which is given to the car. There is no difficulty in providing engines that will run at a uniform speed under all the changes or variation of work that may come upon it.

There are other points of importance which might be referred to in this paper, but it has already extended beyond the primary intention. Our future experience will be guided and aided by the past, and the divisions of the subjects which are but little understood at present, will become as familiar as household words.

Car Ventilator.

The annexed engravings relate to a device for the ventilation of passenger cars on steam surface and elevated railroads. It is known as the "Ober" Car Ventilator, and is reported on by some well-known railroad men as having good features that certainly deserve recognition. The managers of the Boston and Lowell Railroad have equipped all the cars of their White Mountain train with the apparatus, thus giving travelers an opportunity of judging, during the summer, whether this system of ventilation is efficient or not. The arrangement and connection of the parts are simple. Reference being made to the cuts, little explanation seems necessary.

Fig. 1 shows a partial longitudinal section of a passenger car; from this the relative position of the ventilator with the flooring, seats and windows can be understood.

Fig. 2 represents a skeleton car, showing the different pipes and connections in working order.

The operation is as follows: Air is taken in under the car by means of two fans, A, placed side by side on the same shaft and driven by friction connection with the car axle. From these fans the air passes through the pipes, B, extending along the bottom of the car, and is delivered into the tank, D, containing water, and ice, if required, and capable of holding about 100 gallons. Here the dust held in suspension by the air, is deposited, and the latter, as it enters the car, is fresh and clean.

The two air-pipes, C, extending along the sides of the car, are in direct communication with the tank, D, and from them issue the vertical ventilating pipes, E E, placed, as shown, at each side of the car, and furnished with suitable outlets, F F (Fig. 3). These can be turned in any direction at the will of the passengers, and the supply of air may be cut off or regulated by the damper, as desired. The pipes, B, it should be added, are attached to the discharge pipes of the fans by flexible connections, G, so as to permit a motion of the car truck without injury to the ventilating system. The pipes, E, are two inches in diameter, while the square section ducts, C, measure 5 x 7 inches. As it is possible that on roads where very much dust is encountered excessive accumulations in the tank, D, with consequent trouble, might result with the arrangement shown in the cut, where the air supply is taken in under the car, the makers

propose to close the side of the fans and to lead the suction-pipe to the back of the car and to a short distance above the level of the platform. When the train is running at an average rate of speed, the ventilator, it is claimed, will furnish a fresh supply of air throughout the car every twenty seconds, insuring perfect, continuous ventilation. The use of this device entirely obviates all need of opening car windows, winter or summer, for purposes of ventilation, thus avoiding the dust, cinders and smoke so offensive and often dangerous.

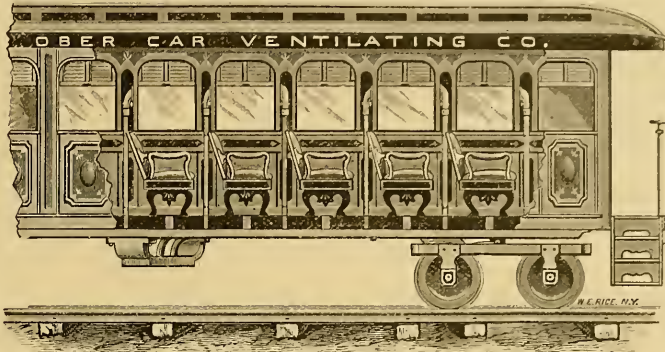

FIG. 1.

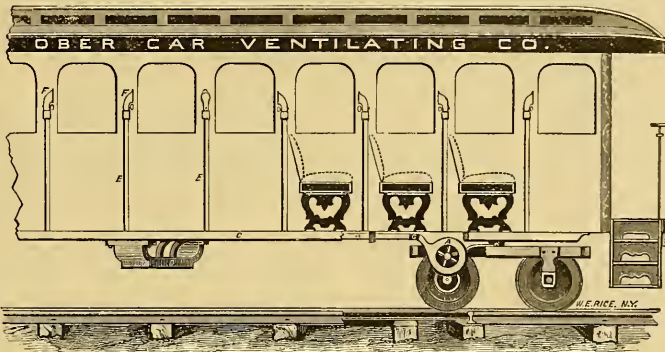

FIG. 2.

- A, Two Fans revolved by friction connections with axle. B, Two Pipes, 5 x 7 1/2 inches, conveying air to tank. C, Flexible connection in pipe. D, Tank for water and ice, holding 100 gallons, more or less. E, Air Pipes, 5 x 7 inches, on each side, and extending entire length of car. F, Ventilating Pipes, 2 inches diameter. G, Ventilator Outlet. Shown in cut at F, Fig. 3, and made to turn in any direction.



FIG. 3.

A New Motor.

Mr. J. B. Huston, of Huron Terrace, has for some time past been experimenting with a street car motor of his invention in East Cleveland and on June 22 received letters patent for his improvement. Mr. Huston is now building a car for the purpose of practically testing his invention. Upon the front platform or beneath the floor of the car will be placed a non-reversible engine of some sort that will be attached to a vibrating lever of the second class. Two friction disks, mounted so as to reciprocate around the rear axle of the car, will be connected with the vibrating lever through a pitman attached to the lever only a short distance above the fulcrum. Upon the axle will be keyed a friction wheel. The two disks will be connected by a cog-wheel that is operated by a lever, so that either one of the disks can be thrown against the

friction wheel. When the engine is started the vibrating lever through the pitman moves the disk backward and forward. If one disk is thrown against the friction wheel the force will start the car and keep it in motion, the backward motion lifting the disk from the wheel so that it will move the car in one direction. The second disk will be used in running the opposite direction. Mr. Huston has tried the motor without an engine, and says there is no doubt but that it will work successfully. The new car will be ready for a trial in about two weeks.

THE showing of the Broadway and Seventh Avenue Railroad Company, of New York, in their report for the quarter ending June 30, is as follows: It shows an enormous increase in its earnings of \$167,551.76, and a decrease in its net profits of \$32,040.13. The operating expenses of 1885 were \$152,277.60; for the same quarter it was \$282,719.47 this year. The balance sheet shows the cost of the road to be \$4,489,242.01; capital stock, \$2,100,000; funded debt, \$2,200,000; loans and bills payable, \$122,638.39; profit and loss surplus, \$82,300.49.

Steam Traction for Tramways.

Humanity and self-interest alike have for many years loudly called for an efficient form of power applicable to street railways. Much thought has been devoted to this end, and many systems have been proposed, operated by soda or other chemical agents, gas, compressed air, electricity, endless cables and steam. Of these the soda, gas and pneumatic systems have not been brought to such practicable shape as to lead as yet to any extensive trials. Electricity is a power from which much is hoped, but as yet it cannot be said to have advanced beyond the stage of experiment. While the electrical current is not in its present development the silent servant desired, it has also not been shown that it can be conducted long distances from the point of generation without a leakage so great as to neutralize any economy which it may otherwise possess. The endless cable, from its great expense, is applicable only to lines of large traffic. In some cities it is in successful use; in others it can as yet be regarded as but experimental. Steam alone has been demonstrated on any wide scale—in the United States alone on a railway mileage of upwards of 115,000 miles—to be efficient, reliable and economical. But as many of the attempts which have been made to adapt it to the requirements of city railways have been unsatisfactory, the following questions naturally present themselves. Is steam a safe, desirable and economical substitute for animal power on city passenger railways? Can it be as easily controlled as other forms of power in use? Is its presence in city streets necessarily objectionable? Can street railways be operated by steam motors as acceptably to passengers and to those living on the streets occupied? Where has the use of steam been tried? What has caused the failure of some and the success of other of these attempts? It is intended herein briefly to answer these questions, with special reference to the steam tramway motors constructed by the Baldwin Locomotive Works, of Philadelphia.

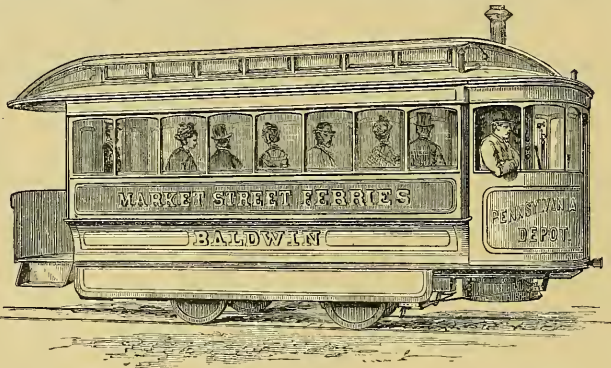

motors are adapted to run equally well in either direction without turning. The weight of a motor for working ordinary grades is not greater than that of a heavily loaded horse-car, and no undue wear of track is involved by its use.

The use of steam power is at this time so thoroughly understood that it seems superfluous to allude to the immunity from accident now enjoyed, where care is used in construction and intelligent supervision is exercised in the use of steam boilers, and this notwithstanding the great increase in the number of steam boilers in use. The boilers of the motors are constructed in the most approved manner, of the best quality of steel, of unusual thickness, so that their safety is assured beyond a doubt, notwithstanding any probable deterioration from time or corrosion. With the safety appliances provided, and with ordinary care, the accidents peculiar to the use of steam are practically impossible.

The construction and working of the steam motors are calculated to make them much safer in operation than cars drawn by horses. There are no horses in front to interfere with the engineer's view, and the steam brake can be applied quicker and is much more effective than the windlass brake, as usually worked by one hand on a horse car.

Curves as short as are ordinarily employed on street railways can be passed without difficulty. The motors have been run on roads having curves as short as 25 feet radius. There is no liability of a motor to leave a track which is kept in ordinarily good repair. The motors are also admirably adapted for working on steep grades. They have been used in Dubuque, Iowa, on grades as steep as 475 feet per mile, or 9 feet per 100, and in San Francisco, Cal., on grades of 486 feet per mile. In the latter

case, however, the use of the motors on this grade was exceptional, it being while the wire cable usually employed was out of service.

Twelve to fifteen miles per hour, with one or more cars attached, can be readily made by these machines. Hence a given distance can be traversed in much less time than a horse car. The motor can stop and start more quickly than horses, and is so readily controllable that passengers can be discharged or embarked in much less time. Furthermore, up grades which require horses to be brought to a walk, steam can maintain its speed of eight, ten, or twelve miles per hour, as the case may be. Without, therefore, actually running any faster when in motion in the crowded streets of a city, the motor can make appreciably better time. A smaller number than of horse cars, therefore, can do the same service, and the number of cars can be materially reduced. The speed at which the motors can be run will give them an important advantage over horses when running through suburban or sparsely settled districts where greater speed is not only unobjectionable but desirable.

The consumption of fuel has been found to be as low as 6½ lbs. of coal per mile run, drawing one car. A liberal estimate may be made as follows of the cost of operating motors under conditions similar to those usual on street railways, where the lighter classes of motors are available for drawing one or two cars, with a seating capacity of twenty persons each, and running, say 80 miles per day.

| | |
|---|-----------------|
| Fuel, at 8 lbs. of coal or coke per mile, 80 miles per day, 640 lbs., at \$4 per 2,240 lbs. | \$1 14 |
| Engineer, 14 hours, at 20 cents per hour | 2 80 |
| Oil, waste and tallow, at ¼ cent per mile | 20 |
| Repairs and maintenance | 1 00 |
| Incidentals | 11 |
| Total | \$5 25 |
| Cost per mile run, say | 6 56-100 cents. |

The steam motors referred to are, in fact, locomotives of suitable dimensions, but with the objectionable features of locomotives eliminated as far as the most approved modern appliances make possible. A house, or cab, covers the entire machine, concealing the motion of the machinery, and giving the motor much the appearance of an ordinary horse car. An exhaust chamber is provided, by which the noise of the steam from the cylinders is muffled or deadened, so that on all ordinary grades little or no puffing sound is heard. The steam from the safety valves, cylinder cocks and brake is diverted into the same chamber, and thus prevented from making a noise or becoming visible. From the exhaust chamber the steam passes through the smoke-box, where it is partially superheated, and escapes from the stack like hot air and not as white vapor. It is thus, without a condenser, rendered invisible in ordinary weather. In damp weather, however, when the hot steam is quickly chilled and condensed after emission from the stack, some steam will show. By using anthracite coal or coke as fuel no smoke is generated. The motion is controlled by a powerful brake, operated either by steam or by a lever, convenient to the engineer and easily worked. In an emergency the motion can also be almost instantly checked by reversing the engine. By either means the motor with car attached can be stopped in less than half the time and space required by a horse car. The engineer has an unimpeded view in all directions, and can control the machine with surprising efficiency. The

The allowance for repairs and maintenance above will, it is estimated, not only keep the machine in repair, but provide a fund sufficient to perpetuate it. These figures are verified by actual results, though the examples at hand are based on motors of larger size than above proposed, hauling heavier loads. On the Wheeling & Elm Grove Railroad, of Wheeling, W. Va., where the motors usually haul two four-ton cars, and at times three cars each, carrying as many as 300 passengers, the total cost of running 100 miles per day is as follows:

| | |
|--|-----------------|
| 100 bushels of coke burned for each motor, at 3 cents..... | \$3 00 |
| Cost of oil, waste and tallow per day..... | 25 |
| Cost of repairs and maintenance per day..... | 75 |
| Wages of engineer..... | 3 00 |
| Wages of fireman..... | 1 50 |
| Total cost of operation per motor per day..... | \$8 50 |
| Total cost of operation per mile run..... | 8½ cents |

(Where anthracite coal is used for fuel the services of a fireman are unnecessary, as the fire can be attended to at the end of each trip, and requires little attention while running.) On the Brooklyn City Railroad, where the steam motors are operated in the outlying parts of Brooklyn, running 100 miles per day, and hauling two cars each, the total cost per motor per day is \$7.00, or 7 cents per mile run.

In the operation of a railway by horses a large outlay is necessary for real estate and buildings for stables and storage of hay and feed, the yearly expense for insurance, taxes and repairs of same, and for hostlers and attendants, much of which can be saved where steam is employed.

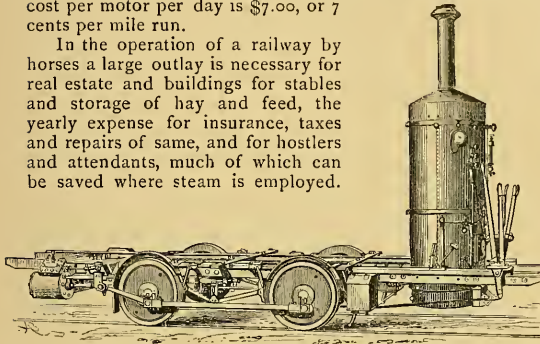

Sheds of one-fourth or one-fifth the size required for stables will suffice for housing the motors.

A frequent cause which has impaired the success of steam tramway engines heretofore has been the effort to use engines and boilers of inadequate power. Designers of tramway engines have reasoned that as two horses with an occasional helper are able to haul a loaded car, an engine capable of developing, say twice three horse-power, will not only be able to do the work required, but have the surplus power occasionally desirable. Experience has indicated that the energy temporarily exerted by a pair of horses during the few seconds occupied in starting a car, or in hauling it over a steep grade, is many times greater than the power they can put forth continuously, and it is also much more effective when applied directly to the ground than through the medium of the rods and wheels of a motor. In the use of steam on tramways, as elsewhere, satisfactory and economical performance can be had only by having boiler and machinery of ample dimensions, and reserve power far in excess of that which is likely to be demanded for the work in view. In many of the efforts to adapt steam to tramway service it has also been sought to do away with the show of steam by condensing it. Condensing may be accomplished by either of two methods: by turning the steam into a tank of water, or by passing it through a system of pipes, usually placed overhead, through which the air can circulate. As, however, it is necessary to restrict the dimensions and weight of the machine, necessarily limiting the size of the condenser, its capacity to condense the steam is correspondingly reduced and it soon gets hot and incapable of performing its functions. No form of condenser has yet been devised which will perfectly condense the steam for any considerable distance, and the back pressure against the pistons involved by forcing the exhaust steam through the condensing appa-

ratus largely impairs the power and economy of the machine. The communication of power to the axles by gearing, so noisy in operation and so expensive in wear and tear, and the use of crank axles, so liable to break, have also been fruitful sources of dissatisfaction.

The Baldwin steam motors are in use on the Brooklyn City Railroad; on the Bushwick Railroad, of Brooklyn; on the Rochester & Lake Ontario Railroad, Rochester, N. Y.; the Cedar Rapids and Marion Railway, Cedar Rapids, Iowa; the Hamilton and Dundas Railway, Hamilton, Ontario; the Street Railway of Grand Rapids, Mich.; the Highland Avenue Railway, Birmingham, Ala-



bama; the Concord Horse Railroad, Concord, N. H.; the Wheeling & Elm Grove Railway, Wheeling, W. Va.; the Mexican National Tramway, Zacatecas, Mexico; the City Railroad, Havana, Cuba; and last, but not least, seventy of them are used in operating the tramways in the city of Sydney, New South Wales, where they have proved best adapted to the tramway service, notwithstanding competitive trials with nearly every prominent European type of tramway motors. The officers of all these roads express their satisfaction with the operation of the motors. The President of the Concord Horse Railroad writes: "I am running our two motors 142 miles, or 71 miles each, per day, with an average consumption of fuel of 6½ pounds of coal per mile run. The motors are now very popular with the people. We have overcome the opposition to them, getting a unanimous vote in their favor both at the Legislature and in the city government."

It cannot truthfully be said that any of the systems of tramway traction in their present stage of development fulfill all the requirements of an ideal motive power, but it may reasonably be claimed that the system of steam tramway motors is accompanied by as few disadvantages as any of its competitors for public approval. As the endless cable has met with as much favor as any of the systems in practical operation, comparisons with it are more likely to be made than with any other system, and such a comparison may here be profitably drawn.

From careful observation of both systems it is confidently stated that no difference exists between them in regard to frightening horses. A spirited horse will take fright at anything which is to him mysterious, unusual, or unexplained. A car moving along the street without visible means of propulsion is to him a mystery, and therefore to be feared. After seeing it a few times, however, his fear wears away, he becomes accustomed to it and passes it without notice. The trouble from frightening horses, as has been proved in many instances, is always more serious in anticipation than in reality, whatever the system of propulsion.

The cable car and steam motor require the same motions to stop them; one motion to release the grip or to close the throttle, another to apply the brake. But these operations can be much quicker and easier performed on the motor than on the car. No greater exertion of strength is required on the part of the engineer than to open and close a couple of well balanced valves, and the operation is instantaneous, but the grip-man must first release the lever applying the grip, and then by means of a hand wheel or another lever apply the brakes. An appreciable time is required for both these operations, and the force of the breaking power is dependent on the volition and physical strength of the grip-man. The steam brake of the motor always applies the maximum braking power, limited only by liability to slide the wheels.

The steam motor, with its car attached, occupies somewhat more space in the street than a cable car of equal capacity, but this objection applies only to crowded streets of cities, where street space is valuable. That it has any

importance is disproved by the fact that where the cable system is in operation, as in Chicago and Philadelphia, it is usual to couple two or more cars into a train, without special objection. On suburban lines, on lines occupying streets of moderate traffic, and on lines in small towns, no objection is likely to be raised to the use of motors on this score.

An important advantage possessed by the motors is that the cars can be heated in winter by steam from the motor.

It is true that in certain conditions of the atmosphere the use of motors is accompanied by some show of steam, and when drawing very heavy loads on steep grades some noise of the exhaust becomes audible, but these objections are no more serious than those incident to other systems. The cable has its own peculiar objections, which are quite as important. It requires a slot in the center of the streets occupied wide enough to catch and break carriage wheels of narrow tread. Calks of horseshoes become fastened in it with great injury to horses. The strips of iron forming the slot make the footing of horses using the same track most insecure, especially in winter when concealed by falling snow. The constant rumble and clatter of a cable are likely to frighten horses on the same street, and are most annoying to those living near it until they have become accustomed to the sound. The cable grip has at times a habit of obstinately refusing to "let go," and again it will with equal obstinacy refuse to "take hold." Both faults are likely to result in serious accident. The trench containing the cable is a sink collecting rain and filth, obnoxious and prejudicial to health while being cleaned.

If accident occurs to a steam motor another can take its place without interruption to traffic. One or more spare motors can be kept ready for service to take the place of any, subject to accident or requiring repairs. If accident occurs to any essential part of the complicated system making up the plant of a cable railway the entire traffic must stop until repairs can be completed, the cars over the entire line stopping without explanation and without warning to passengers, whose prompt and certain transit may be of the utmost consequence, and who have no means of knowing whether the delay may be for five minutes or five hours.

It is to be regretted that it is not possible here to present a comparison of the actual cost of running and repairs of both systems. In view of the enormous first cost of the cable system, with its correspondingly large yearly interest account, the enormous wear and tear of a moving cable several miles in length, with the wear and tear and lubrication of the friction wheels on which it must run, the cost of fuel, operation and maintenance of the expensive machinery at central stations, the wear and tear of grips and rolling-stock, added to the wages of grip-man for each car, nearly as great as those paid the engineer of the steam motor, it seems obvious that the cost of operating a cable line must largely exceed that of one of equal traffic operated by steam motors. This being true where the traffic is considerable, how much more is it the case in our smaller cities and towns where smaller traffic and smaller receipts must be counted upon.

It is, indeed, roads of the latter description that will find the motor system especially desirable. The motors can be run over existing tracks without alteration, the lines can be equipped and operated with them with less expense than by any other system; they can run as fast as may be desirable, they can on special days, or whenever occasion requires, haul several cars each, greatly increasing the earning power of the roads; they present as few objections as any other system of proved practicability, and it only remains for their advantages to become more generally known to ensure their very general introduction.—*Communicated.*

EVEN the Parisian omnibus drivers show a sense of humor at times. The other day an old lady of colossal proportions hailed a stage and inquired of the conductor if there was any room for her inside. "No, madam," politely replied that official, "there is only room for one."—*French wit.*

YOUR true American is ready to paint almost anything red but the flag he carries.—*Philadelphia Press.*

Union Rapid Transit.

Almost since the beginning of the year the board of Aldermen have been importuned, every now and then, to grant the Brooklyn, Bath & West End Railroad the right to extend its tracks from the present terminus at Greenwood Cemetery down to the Hamilton ferry. The president, and it might be said, the head and front of the company, is E. B. Litchfield, whose recently deceased brother built up the great Litchfield estate of South Brooklyn.

The proposition was to run an elevated road from Hamilton Ferry up Sackett street to Smith, down Smith to Butler, up Butler to Fifth avenue, thence along that thoroughfare to connect with the steam road formerly known as Gunther's and now owned by a syndicate of Philadelphia capitalists, with Mr. Litchfield as president. The latter held and holds that an elevated road running from Hamilton Ferry would build up that part of Brooklyn known as Gowanus, like magic.

But the common council has not as yet taken action on the application. Mr. Litchfield recently dropped in at the city hall in hopes of being able to learn what chance there was for action on his application before the Aldermen took their vacation, but as none of the statesmen were on hand, and as no one else could give him the desired information, he had to go away no better informed than when he came.

"Our application," Mr. Litchfield said, "was sent to the board of Aldermen on Feb. 5, and I have since asked several times for a hearing, but none has been granted me. Any one who doubts our good faith in the matter should look at the names of our directors. They are mostly all Philadelphians, among them Jay Cooke and John M. Butler, bankers; Percival Roberts, president of the Pencoyd Iron Company; W. Frederick Snyder, president Northern Savings Bank; James G. Lindsay, iron merchant; W. A. Ingham, director Lehigh Valley road; Frederick Prime, jr., president Allentown Iron Works; Charles F. King and John T. Dyer, wealthy railroad contractors, and John Dickey, woolen manufacturer and bank president. There are several among these gentlemen either one of whom could afford to bear the whole expense of building an elevated road such as we propose. They are also associated in the purchase of lands under an organization known as the West Brooklyn Land and Improvement Company, and now hold about two thousand five hundred lots a short distance from the city line and upon the line of the Brooklyn, Bath & West End road. Ten buildings have been commenced there already, and many more are soon to be begun.

UNDERGROUND RAILROADS.—Under the statute, approved March 12, 1879, supplementary to the general railroad act of New Jersey, corporations formed to construct underground railroads are not entitled to condemn the fee-simple of lands for their right of way, but only a right to construct, operate and maintain a railroad upon, through, and under the land of another. Railroad corporations formed for this purpose cannot, however, condemn for a merely temporary use until, by the operations of the land owner, the existing site of the road shall be destroyed. The corporation cannot claim the condemnation of a right in the event of the bed being removed to support its tracks upon other property of the owner, as this is of the nature of the creation of a future contingent right, and the statute imports only the acquisition of the present rights, and of whatever may be necessary to make those rights perpetual.—*Hibernia Underground Rd. Co. vs. De Camp and others. Court of Errors and Appeals of New Jersey, 4 Atlantic Rep. 318.*

THE power to extend streets across the right of way and tracks of a railway company is implied in the general authority conferred by the city charters for such purposes without express legislative provisions upon the subject, according to the decision of the Supreme Court of Minnesota, in the case of St. Paul, Minneapolis and Manitoba Railway Company vs. The City of Minneapolis.

Method of Attaching Electric Motors to Tramcars.

It would seem that the development of the electric propulsion of street cars might be greatly advanced by a device to allow of a ready and cheap method of attaching the motors to the existing cars. Acting upon this idea, Mr. John M. Pendleton, whose far-sighted inventions in connection with the electric propulsion of cars we have already had occasion to refer to, has designed an ingenious plan of attachment for this purpose, which we illustrate in the accompanying engravings, Figs. 1 and 2. These show respectively a front and side elevation of a car equipped with the motor, according to Mr. Pendleton's plan. The general arrangement of wheels and axles, it will be observed, is the same as that of the ordinary horse car.

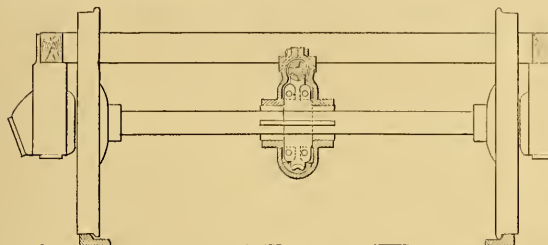

FIG. 2.

The electric motor is suspended from the floor of the car, and the revolving armature carries a coiled spring extension at each end, terminating in a worm or screw-pinion wheel, held by journals on each side.

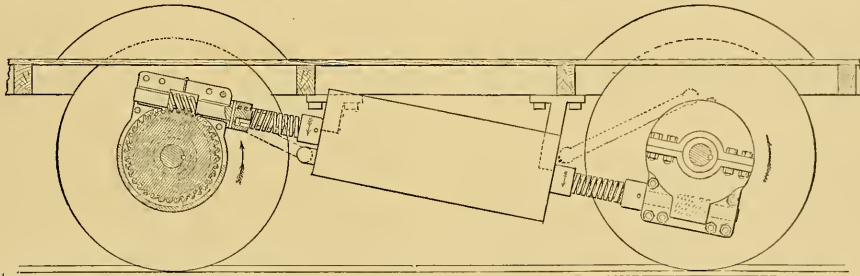

FIG. 1.

The interposition of the spring presents several advantages, for it not only allows for the distortion of the car with varying loads, or from other causes, tending to throw the axis of the motor out of line, but in addition the springs relieve the axles of any sudden strain due to rapid starting or stopping of the motor. The retaining links beside the springs allow of torsion, but limit the extension and contraction of the shaft where heavy strains occur, such as on the ascent of heavy grades.

It will be noted that the two axles are differently geared, one having the worm pinion on the top and the other at the bottom of the worm wheels, respectively. By this arrangement the thrust on the motor is equalized and friction on the collars is avoided.

The worms are cut with a coarse pitch so as to allow free movement of the car; but the speed is reduced by the worm wheels attached to the axles, in the ratio of 12 to 1, enabling the motor to operate at the rate of 1,000 revolutions, corresponding to a speed of eight miles per hour for the car.

With the idea of adapting the system to existing rolling stock, the worm wheels are split and securely bolted to the axles and keyed in addition. The hub of the split worm-wheel carries a cover or box, which is made oil-tight and which surrounds the worms. These boxes are filled with oil, which insures a constant and copious lubrication, re-

ducing the friction and wear to a minimum, and preventing the access of dust to the working parts.—By courtesy of *The Electrical World*.

The Toronto Exhibition Electric Railway.

The new locomotive for the electric railroad now being constructed in the shops of the Toronto Electric Light Company will be ready for a trial trip soon. It is expected to develop about 40 horse-power, and is entirely novel in construction and design. It is altogether the work of the company's electrician and mechanics, and the first of any kind constructed in Canada. The entire operations of the railroad, hauling the cars, stopping, starting, applying the brakes, illuminating the headlight and ringing the bell will all be performed by electricity, manipulated by switch levers on the forward part of the motor car. A current of electricity of sufficient power to accomplish this work will be generated by apparatus placed in Machinery Hall and driven by an automatic steam engine owned by the association. Neither time nor expense is being spared to make this the most complete and interesting exhibition of what can be accomplished by means of electricity.—*Toronto Globe*.

New Elevated Railroad Locomotive.

The Mechanical Department of the New York Elevated Railroad have recently designed a new locomotive for service on the road. This engine is intended as the heaviest standard, and was designed with a view of handling five-car trains now run during commission hours. A modification of the Belpaire fire-box is used, but the outside shell, while kept flat, is not sloped in a way that might restrict the steam space. The only wood-

work used about this engine is the boiler lagging and the cab window. Steel is used for every piece and casting where its application could reduce the weight. Steam chest casings and dome casings are steel castings, and the diamond truck castings are mostly of steel. The fire-box and grate area have been increased, and the boiler has got 154 tubes 1½ inch diameter, that being twenty-two more than the other boilers.

The cylinders have 1 inch more diameter than the other engines, and in working order the engine is one ton heavier. One engine of this type was built at the company's shops at Ninety-eighth street, New York, lately, and is now in service. A very close record of her performance has been kept. She is doing the work on 29 pounds of coal to the train mile, and is evaporating 7¼ pounds of water to the pound of coal. The link motion is new, and was designed by Mr. John D. Campbell, general foreman of the shops, who schemed it to give as nearly as possible equal distribution of steam for forward and back gear.—*Nat. Car and Loco. Builder*.

Do not get mad when a man smokes on the platform. Merely remark to him in a kindly tone that considering what atrociously bad cigars he uses you are very thankful that he has the good taste to use the platform instead of the inside of the car.

THE STREET RAILWAY GAZETTE

SEPTEMBER, 1886.—MONTHLY, \$2.00 PER YEAR.

COPYRIGHTED JULY, 1886.

THE WRIGHT-MONROE CO., PUBLISHERS.

GENERAL OFFICES:

CHICAGO, CHICAGO, NEW YORK.

CHICAGO, 43 LAKESIDE BUILDING.

P. G. Monroe, General Manager. E. V. Cavell, Business Manager.

NEW YORK, 181 BROADWAY, CITY.

H. D. Cozens, Business Manager. T. P. Pemberton, Associate Editor.

Augustine W. Wright, Henry C Lockwood, George B. Heckel, Editors.

BRANCH OFFICES.

PHILADELPHIA, Pa., 24 N. 4th St., J. Waterkeyn, Manager. ATLANTA, Ga., Chamber of Commerce Bldg., Wm. Minnigerode, Manager. SAN FRANCISCO, Cal., 1322 Pine St., G. W. Fairchild, Manager.

Announcement.

The annual convention of the American Street Railway Association will be held at the Burnett House, Cincinnati, Ohio, commencing on October 20. The following gentlemen will constitute the reception committee: John Kilgour, A. J. Clark, George B. Kerper and James M. Dougherty.

Headquarters will be at the above hotel, where the best rooms will be reserved for the accommodation of the delegates.

Supply men are cordially invited to make a display of their goods, and all requisite room will be placed at their disposal without charge, on the ground floor of the hotel.

After the business of the convention shall have been disposed of, there will be ample time for sight-seeing and sociability. The banquet tendered to the visitors by the street railways of Cincinnati will take place at the Burnett House on Thursday evening, and a most enjoyable time can confidently be predicted.

LET us study causes that produce economic effects.

A SYSTEM of homes for the people is the most effective insurance against anarchy.

WRONG is a boomerang that flies back against the man who makes use of it.

EMPLOYEES should have a higher motive to do well beyond the desire to retain their places.

If the anarchists escape the gallows and go to the penitentiary they will become actual laboring men, instead of mere labor agitators.

THE housekeeping wives of the laboring man work without ceasing. They are harassed, driven, worried, reproached and looked down upon. They die in harness, but never strike.

THE experience of Chicago with anarchists should not be lost on other cities. The anarchists of New York and Cleveland are talking with unrestrained violence, and these cities might prevent such an outbreak as occurred in Chicago by prompt action.

THE laborer was once a serf; then his liberty was circumscribed for centuries. He now wanders on a borderland of a future of independence and comfort unknown in the history of the world.

HERR MOST has not been heard to express any opinion of the result of the anarchists' trial. This, under the circumstances, is even a higher proof of his caution and conservatism than his crawling under the bed.

THE lower House of the New York Legislature has passed a bill authorizing any horse street railroad company to change its line to the cable system on obtaining the consent of one-half of the property owners along the route.

A STRIKE was recently started on the ground that the street car drivers had nothing to "sit down on." This is quite strange, for the very strike they had instituted would have been an excellent thing to "sit down on."

"CO-OPERATION is a good thing; arbitration is a good thing; profit sharing is a good thing; but let us remember amid all this discussion that every hope of a permanent reform in industrial and social life must be illusory unless it has a firm foundation in a lasting state of reformation."

THE anarchists claim that they did not manufacture bombs to kill policemen, but to destroy certain systems of government which, in their opinion, had become effete. It is doubtful if the State of Illinois will hold that its intention is to annihilate the system of the anarchists, and not to hang the murderers of the guardians of the peace.

If a country is infested with brigands, as some claim Mexico is, it has been suggested that the proper way to reform it would be to introduce a railway through its affected sections. Upon the same principle if an avenue becomes the abode of bad characters a street railway should be run through it; and with an electric light its morality might permanently be established.

CORNELIUS VANDERBILT proposes to erect a building, with gymnasium, reading room, library, bowling alleys and other attractions, for the use of railroad employees in the service of the companies whose lines converge at the Grand Central Depot. It is conditional that the building be erected on the New York Central Railroad Company's land at Madison avenue and Forty-fifth street, 40x80 feet. The company have accepted the offer.

SUCCESSFUL trials of electric street railways are continually made in different parts of the country. But this form of motive power has not yet been adopted in the larger cities. A person who has a tendency to indulge in sportive humor suggests that these great communities are content with being able to electrify their people through their statesmen who chiefly congregate in the city council halls.

How unfortunate for Cutting that he was released from a Mexican dungeon. After his discharge, and before he was allowed to breathe the free air of Texas, some naughty officials tried to trump up a charge of a new offense, when an American horse car, which seems to have invaded even this remote region of the world, opportunely arrived, and the would-be national martyr was hurried to a seat and, rapidly as a Kentucky mule could trot, driven across the border. No prancing steeds, no Mexican saddles, no sombreros, no clanking spurs—only the jingle of a horse car bell. How unromantic; but how practical!

DO NOT ask a conductor what he thinks of the reigning dramatic star, the new prima donna, the last great painting by Whistler, or the new series of grand symphony concerts. It is cruel to thus remind him of the halcyon days before the bell-punch was invented.

Grappling the Grip.

The objection of the members of the legal fraternity to the construction of the cable road by the North Chicago City Railway Company has taken practical form. A barrister and certain property owners of that city have filed a bill against the railway company, the City of Chicago, Charles Y. Yerkes, F. L. Threedy, H. Crawford, T. H. Wentworth, Sr., James M. Clifford, Warren T. Furbeck, Edward C. Markham, and William D. Meeker. The defendants are restrained "from tearing up, removing, or in any manner interfering with North Clark street north of the north bank of the Chicago river, or the roadbeds or pavements thereof, for the purpose of constructing, maintaining, or operating any system of cables, to be used in moving, or from running or operating cars in said streets moved by any such cables, or other animal power, or from excavating or constructing any trenches, or running any cables therein, or from constructing any machinery, grip-cars, or other appliances for a cable system, in, upon, or under the surface of said street."

The bill upon which this injunction was granted, is a remarkable one. It sets forth that Clark street has repeatedly been torn up by gas, electric light, telegraph and telephone companies. After stating this rather irrelevant fact, the complaint follows with a highly technical description of the construction of the proposed cable road, in which the rails and the subterranean trenches which form part of the cable road are particularly objected to. One would think, on reading this famous document, that the persons who survived the obnoxious gases emitted from the roadbed, would only live to be destroyed by the vast juggernaut of cars which would traverse the streets at a dangerous speed.

The bill goes on to allege that the laying of the tracks now upon the street was only permitted by the complainants, grantors, and other proprietors, and by the common council, upon certain conditions contained in the ordinance of May 23, 1859, which provided, among other things, as follows:

"The cars to be used upon said tracks shall, within the limits of the city, be propelled by animal power only, and the said tracks and railways shall be used for no other purposes than to transport passengers and their ordinary baggage, and the cars or carriages used for that purpose shall be of the best style in use on such railways."

It is claimed that the owners of property along this line acquired certain rights that would be taken away by any use of the streets inconsistent with such conditions; and that a horse railway having once been authorized, that it would be illegal ever to change the motive power. The gravamen of the complaint seems to be that the common council had no authority in June, 1886, to grant any new privileges to the present company, and because the original charter of the North Chicago City Railway Company only authorized that corporation to construct and operate a horse railway, that it is bound under its charter to use animal power only.

The barrister who instituted this suit has made it a very personal one. He is one of the plaintiffs; he is his own counsel (violating a well known adage among lawyers) and his wife kindly goes on the bond as surety in order to allow the temporary injunction to issue. His property is on Clark street, and when he is so fortunate as to build upon the south part of it, the front entrance of his domicile will be on this street. Life, he thinks, will be scarcely tolerable with the bells of the cable cars continually ringing in front of the house which now remains a *chateaux en Espagne*. It seems difficult how the courts are going to treat the part of the bill that deals with this imaginary and subjective hamlet, as a material allegation. When this injunction, which is correctly called a temporary one, shall have been set aside, the baseless vision of the over confident barrister's new home dissolved, the cable road with its perfected intramural transit completed; then the practical and sensible people of Chicago will realize, that \$10,000,000 have been added to the assessed value of the real estate of that city.

Ex-Presidents.

The Roman generals and senators returned to the experiences of farming and agriculture after they had completed the performance of their duties on the battle-field or in the council hall. They did not resume this simple life as superintendents, but actually held the plow in the furrow. They believed that while the temple of Janus remained closed, the best way to serve their country was to cultivate the fields. This example of virtuous and frugal life encouraged sturdiness, honesty and heroism among the people. This simple city of life, accompanied by a high regard for the development of the human form, constituted the foundation of a superior race of men.

Under our form of government the President has imposed upon him the exercise of great power, but when he steps down from his high station he must generally resume the humble walks of private life. Several of our ex-Presidents have followed the example set by the Roman, and retired to their farms to participate in the cultivation of the soil. Others have sought retreat in pleasant suburban homes where they have occupied themselves with their books and correspondence. President Hayes is said to spend his time in true simplicity, by superintending the natural and artificial incubation of eggs in his model henery.

The public will not be troubled with the question as to what use to put ex-President Arthur.

Notwithstanding the conflicting rumors that have been circulated concerning the connection of ex-President Arthur with the Arcade Railway corporation, it is now definitely stated that this gentleman will occupy his time in the completion of this great work, which, when completed, will constitute a lasting monument to his memory. His name is painted on the door of the handsome offices in the Boreel building, where he is recognized as the President, but for many weeks he has been out of town and incapacitated by illness for the duties of the position. Vice-President Smith went up to New London to see Mr. Arthur. He says: "I was highly gratified to find President Arthur gaining. He looks perfectly well, though by the advice of his physicians, he will remain at Newport a while longer before he returns to active work. When the Presidency of this road was offered him, he declared that if he accepted it would be on the understanding that he was to perform the duties of the office in person, and not act as a mere figurehead. He further said that if, by reason of ill health, he should be prevented from serving as an active executive, he should resign. He is looking forward with no little pleasure to the time when he can come back to the city and assume control of this corporation."

The ex-President is a hearty believer in the Arcade project, which contemplates a railroad following the course of Broadway underground. It is meeting with opposition just now from the Astors, Lorillards, and other owners of Broadway property, but the company is going ahead under its charter as if nothing had happened. The officers expect to begin construction before winter. Mr. Arthur said of the scheme, before his election to the Presidency of the company, that it was one of a few enterprises with which he should care to be connected. He will be interested in it in other respects than as a salaried official, but to what extent cannot be stated. It is certain, however, that more money will be put into Arcade stock by friends of the ex-President's than by himself. And it is safe to say that this money would not be invested in the enterprise if Mr. Arthur were not at the head of it.

"WELL, JOHN," said the judge to a pig-tailed Celestial, "what can I do for you?" "Want to getee name changed." "What's your name now?" "Sing Sing. No goode. Too muchee adelman. Getee changed to Walble Twicee." "To Warble Twice?" "Yep. Alle samee Sing Sing."—*N. Y. Times.*

WHEN A 250-pound man treads on your corns in getting in and out, do not call attention to the size of your feet by making a fuss about it.

Industrial Education:

It is quite well known that only about two per cent. of the children who attend public schools go to college. The question that naturally arises is, whether we shall educate these children as if they were to be prepared to lead literary lives, or to work for their livelihood. There can be little doubt in the minds of thinking men that the whole system of public education should be revolutionized. It seems to be agreed that some new form ought to be adopted. The question is how practically to carry it into effect. There is no argument about the advisability and efficiency of this means of education. Boys from 10 to 12 years of age and upwards ought to be taught, in addition to their regular studies, the use of tools, working in clay, wood and iron. The great object to be attained is so to familiarize the boy with the use of tools of every description that he may be able to reduce the period of his apprenticeship about four years. Girls should be taught sewing and needle work as well as cooking.

Industrial education should not be introduced into the present school buildings, but new buildings should be erected for this special purpose. The pupils could then be sent to the new from the regular schools a certain number of hours each week.

When we consider the number of commercially educated men who may be found in any of our large towns and cities, vainly seeking employment, it need hardly be argued that some salient change is necessary in the training of the youth of the country. Manual labor is in disrepute with the American boy. He does not like the farm or workshop of his father. He does not like to follow the sea. The consequence is that the land is not properly tilled—the factory is filled by foreign born, and the ship is manned and officered by every nationality save the American. A nation to be truly great must not import its farmers, its workmen and its sailors. This people must not fail to educate its youth in all the arts of manufacture and commerce and thus avert the fate that has overtaken other nations which have fallen into effeminacy, corruption and decay.

Labor Legislation.

Many noteworthy changes in statute laws on points of general interest were made in the several states and by congress during the last year. It need hardly be said that this legislation ought to be interesting to cultivated business men whose operations extend beyond the confines of a single locality, and whose commercial and business relations are directly affected by the changes in the law. It is quite natural that legislation exclusively on the labor question should have been stimulated by recent occurrences. Tribunals of arbitration to settle disputes between employer and employees have been authorized in Connecticut, Iowa, Kansas, New York and Massachusetts. Another statute provides for the weekly payment of wages by corporations. A Rhode Island statute requires a like notice of intention on the part of an employer as the employer requires of the employee in respect of an intention to quit work, as a condition in either case of a forfeiture of wages. In New Hampshire the offensive intermeddling of strikers with other laborers is prohibited.

By a Massachusetts law, corporations employing labor are authorized to issue special stock to be held only by their employees. A Connecticut statute permits corporations to distribute a portion of their profits among their employees. The recent laws of Michigan and Massachusetts provide for the protection of employees on railroads and in manufacturing establishments. These statutes go further in the direction of making profit sharing an accomplished fact than anything that has hitherto been done. If the ideas which lie at the foundation of this legislation are pursued, the dream of a rather imaginative writer that the employed "should be, as much interested in, and as much a part of the corporation or company he works for as its road-bed, rolling stock, mill or machinery," may be realized.

Bomb Murderers.

Anarchists, who strike blindly at innocent persons with whom they have no quarrel, in order to destroy law and society, are fiends in human form. They are guiltier than the railway wrecker. They should be put out of the way as one kills a poisonous snake. Let the law stand between the bomb murderer and the lives of public officers and private citizens. The honest workmen who compose the great body of the population is as much interested in the enforcement of the law which protects their homes and their families as the capitalist.

"As a cause celebre, likely to exercise a lasting and favorable influence upon the administration of our criminal law, the importance of the Chicago trial can not be over-estimated. But its crowning importance lies in its educational value. It has taught the American people to hate the loathsome doctrines of the social destructionists, and it has killed the exotic plant of anarchism before its roots had spread widely and fastened it firmly in our soil. It has furnished an impressive object-lesson, and has thereby accomplished what thinkers and writers on social questions might have labored long and vainly to effect. A marvelous clarification of popular ideas will follow as its immediate outcome. It has aroused the people to a realization of the nature of the rabid socialism preached in our large cities, and they will not countenance it or trifle with it any longer. The legitimate labor movement will shake itself clear of all suspicion of sympathy with the odious doctrines of Most, Schwab, Spies and that class."

A New York paper, which takes a more international view of the subject, says: "The conviction of the bomb-throwers, bomb-makers, and bomb-teachers at Chicago will probably assist even the senate of the United States to a clearer perception of the status of dynamite in the list of things extraditable between nations."

New Street Car Motor.

St. Louis *Republican* says Mr. Henry Silvester has received a despatch from the Patent office at Washington, announcing that his application for letters patent had been granted. Mr. Silvester has been at work these many months arranging and perfecting a motor for street cars, and is now satisfied that he has the best invention of the age, far eclipsing electricity, combustion engines, and the different cable and grip patents. The new claimant for honors is called by the inventor and patentee the Automatic Motor for the propelling of all kinds of rolling stock. The motor is a very simple and cheap contrivance, being run by compressed air, the air being placed in five small pumps. The power is contained in these pumps, which are suspended between the axle and car body. The air being pumped in by the vertical oscillation of the car is entirely self-acting. The pump is peculiar and is said to be unlike any other pump in existence. Besides being very sensitive it consists of four telescope chambers. The telescoping motion is constantly going on, and the power, *i. e.*, the compressed air, collects in one end—the large end of the pump. Mr. Silvester has shown his model to the various street car magnates, and they have decided to experiment with it. There will soon be a meeting of the street railway men, and Mr. Silvester will be called upon to explain to them its workings. In a few weeks a working model is to be gotten out. This motor can be applied to the present street cars without altering the track, the rail, or the car. It occupies but little space, and that under the car. The cost per car is estimated at \$400. Mr. Silvester says that his invention is the result of pure accident. He was working upon a model for a patent automatic railroad brake, and he found the power of this pump so active that he let the brake scheme go and perfect ed the present motor.

WHEN the conductor yells: "A little closer, please," pay no attention to him unless a pretty girl is sitting next to you.

American Street-Railway Association.

President—Julius S. Walsh, President Citizens' Railway Company, St. Louis, Mo.

First Vice-President—William White, President Dry Dock, East Broadway and Battery Railroad Company, New York City.

Second Vice-President—C. B. Holmes, President Chicago City Railway Company, Chicago, Ill.

Third Vice-President—Samuel Little, Treasurer Highland Street Railway Company, Boston, Mass.

Secretary and Treasurer—William J. Richardson, Secretary Atlantic Avenue Railroad Company, Brooklyn, N. Y.

Office of the Association, cor. Atlantic and Third Avenues, Brooklyn, N. Y.

The fifth annual convention of the association will meet in Cincinnati, O., on Wednesday, October 20th, 1886.

Personals.

J. B. HANNA.

We regret to learn that Mr. J. B. Hanna, Secy. of Woodland Ave. and West Side road of Cleveland, will not be at the convention, having made arrangements to leave for Dakota early in the month, for a well-earned vacation.

JOHN KILGOUR.

Mr. John Kilgour, Pres. Cinti. Consolidated St. Ry., who has been spending several weeks by the sea, after a long siege of sickness, has returned to resume his official duties.

A. H. HAYWARD.

Mr. A. H. Hayward, who operated the Daft road at New Orleans, and has had charge of the Daft street railway at Baltimore, has gone to Los Angeles to install a Daft plant there for electric street railway purposes.

V. C. TURNER.

V. C. Turner, late president of the North Chicago City Railway Co., contemplates building a handsome residence on the Lake Shore drive, just north of Franklin MacVeagh's new mansion.

HENRY ROOT.

Henry Root, of the engineer corps of the Central Pacific Railroad of California, who has charge of all the cable traction street roads in San Francisco owned by that road, passed through Chicago, Aug. 4, en route to New York City.

L. SNIFFEN.

PUBLISHERS STREET RAILWAY GAZETTE:—Gentlemen: An item in your issue of August (copy of which you sent me) is entirely without foundation.

The same item was published in the Railway Register in June, and I wrote them contradicting the report. The whole matter is a huge joke on me. I am not interested in railroad matters at all, but am a drug clerk. Know nothing of railway matters at all.

Please give me the benefit of as large an edition to show the error, as the one containing the item. I do not care to get so much uninteresting mail matter as I have had lately.

Yours etc.,
LOU SNIFFEN.

[We regret that we are compelled to state that a street railway is not to be built between Valatie and Niverville, N. Y., and that so much free advertising has been lost. It is hoped, however, that our item, so innocently printed, will bear good fruit, in exciting he enterprise of Mr. Sniffen, or other public spirited citizens of that place, to construct a road for the good people of Valatie, if they really want one.]

H. H. LITTELL.

H. H. Littell, Supt. of the Louisville City Ry. Co., who has been on a "chicken-hunt" in Dakota and Minnesota, has returned, browned and sun-burnt, having had a glorious time.

C. S. GOODRICH.

C. S. Goodrich, Supt. of the Minneapolis St. R. R., has returned to headquarters from an extended trip to the sea shore.

TOM L. JOHNSON.

Mr. Tom L. Johnson is still in Brooklyn, N. Y., on business.

CHARLES HATHAWAY.

Mr. Charles Hathaway and Mr. Frank D. H. Robinson are both East, on a combined business and pleasure trip.

W. E. HAYCOX.

W. E. Haycox, Asst. Supt. of the East Cleveland St. Ry., feels good—Aug. 12th,—girl—7 lbs.—mother and child doing well.

H. A. EVKRETT.

Mr. H. A. Everett, Sec. of East Cleveland St. Ry., is still honeymooning it away down Maine somewhere, and seems to be enjoying himself hugely.

Pointers.

ALABAMA.

Birmingham.

The Milner Spring & Birmingham Street Railroad Company, capital stock, \$25,000, has been incorporated.

In the case of the Birmingham & Pratt Mines Street Railroad Company against the Birmingham Street Railroad Company, the Supreme Court has dissolved the injunction. In 1832 the city granted the latter company the right of way on several streets and afterward granted the other similar powers. As some portions of the route were coincident, litigation ensued. The court has decreed that under the constitution, no exclusive power can be granted, and therefore that the city had a right to give its consent to both corporations, neither of which can claim an exclusive ownership.

The Western Valley Street Railroad Company, capital stock \$50,000, has been incorporated.

ARKANSAS.

Pine Bluff.

The Citizens' Street Railroad Company, capital stock \$30,000, has been incorporated and has commenced work. President, V. D. Wilkins; vice-president, H. S. Bradford; treasurer, H. H. Hunn; secretary, John O'Connell.

CALIFORNIA.

Los Angeles.

The managers of the two-mile street railroad will experiment with electric dummies and cars fitted with electric motors, and will operate the line with whichever proves most satisfactory. They have given orders to the Daft Electric Co. for two dummies and two Brill cars fitted with the Daft motor. This is a regular commercial order, as the Daft Company has refused to experiment any more, but is ready to equip any road, either with overhead, surface, or underground conductors.

FLORIDA.

Gainesville.

A street railroad is shortly to be constructed and a company is being organized.

Jacksonville.

The contract for building the Belt Railroad around the city has been awarded to John Stewart.

Sanford.

At Sanford a movement is on foot to establish a street railway.

GEORGIA.

Columbia.

Work is progressing rapidly on the new street railroad. Main street is being double tracked and the line will shortly be completed to the depot.

Dublin.

A charter for a street railroad has been granted by the city to Capt. J. M. Smith and Dr. R. H. Hightower; they are required to have a portion of the line in operation within twelve months.

Thomasville.

Several prominent citizens have taken up the question of establishing a street railroad, and

the prospects are good for the materializing of the scheme.

ILLINOIS.

Chicago.

Licenses to incorporate were issued by the secretary of state, Aug. 13, to the Illinois Cable Transit Company, of Chicago, capital stock \$400,000; incorporators, Louis C. Wachsmuth, H. W. McNeill, DeWitt C. Creiger, and Forbes Trochilich.

An improvement to the village of Hyde Park, to cost in the neighborhood of \$1,000,000, is now being discussed by the village authorities. It consists of the extension of the cable system of the Chicago City Railway Company from the city limits south to Sixty-seventh street on Cottage Grove avenue, and on Fifty-fifth street from Cottage Grove to Lake avenue, the route now occupied by the company's steam dummy. The officials of the company state that the work will be commenced as soon as they get the necessary permission. In connection with the laying of the State street cable the trustees have passed the following:

Resolved, That the center between the tracks of the cable railway on State street, between Fortieth street and Sixty-third street, be a straight line, the terminus of which shall be one foot west of the center point at Fortieth street and Sixty-third street, the town of Lake concurring therein.

The Cook County Rapid Transit Company has been incorporated to build a suburban line from the southern city line of Chicago, at Vincennes avenue, to the Indiana state line.

The Chicago Passenger Railway Company notified the street department recently that the work of laying track on Western avenue from Harrison to Twelfth street would be commenced and probably be continued to Twenty-first street and from Western avenue to Blue Island avenue, and thence eastward to Centre avenue. The Western Division also gave notice that it would lay tracks on Eighteenth street from Ashland avenue to Wood street. After this work is done the city will pave the street.

Judge Tuley issued perpetual injunction upon petition of Byron L. Smith and Reid, Murdoch & Fischer, restraining the Chicago Passenger Railway Company from maintaining more than two tracks upon that part of Michigan avenue in front of the complainant's premises, and from using that portion of the street for any other purpose than the continuous passage of cars. The company consented to the issuance of the injunction, which was entirely amicable. Contracts were made by the company with the owners of property upon Michigan avenue binding the company to use that portion of the avenue between Adams and Washington streets for no other purpose than the continuous passage of cars. It was in pursuance of these contracts that the injunction was entered to make the agreements inviolable.

The West Side Railway Company, August 6, paid to the city collector \$2,988, as license fees for the last quarter. From the returns made by the company 285,987 trips have been made during the last three months, which averages 239½ cars with a daily average of thirteen trips.

The Mayor, on Aug. 7, authorized Frederick G. Wheeler to run a new motor, to be called the Lillie, to propel the cars of the West Division Railway on Ogden avenue, between the stables of the company and Douglas Park. The permission granted is for the purpose of testing the feasibility of running a dummy train on the West Side road west of Western avenue, and will only continue until Dec. 15. The new motor will be propelled by a new mechanical method which will utilize compressed air instead of steam.

The West Division Railroad Company will relay their track on Madison street with steel rails while the city is improving the street. The city has given the company permission to experiment with a new cable system on Madison street, west of Homan avenue.

The North Chicago City Railway Company has accepted the ordinances passed by the board of trustees of Lake View, Aug. 2.

The North Side Street Car Railway Company on August 9, paid to the city collector the

amount of its license fee for the past three months. The rather unique statement was made that 122,374,1000 cars were run, averaging thirteen trips daily, which aggregated 146,359 trips in all. The amount of the license fee paid was \$1,529 67.

The residents of the West Division are getting very uneasy over the delay attending the erection of the proposed double iron bridge at Jackson street, for which there is an appropriation of \$505,000 lying idle in the treasury. Ald. Wheeler headed a delegation of West Side wheelmen, who called upon Commissioner Purdy in the matter, and to find out why something was not being done. They claimed that the appropriation had been made before a bridge at Twelfth street had been thought of, which was now well under way, and that the city authorities had been simply guilty of neglect, or else the Jackson street bridge would now be far advanced. Mr. Purdy explained that the only thing in the way of the Jackson street improvement was, the city had been unable to get the railroad companies to come to terms about the land necessary to swing it over, and showed them the correspondence already had on the subject, wherein the promise had been made as much as a month ago that the matter would be determined at an early day. They were inclined, however, to think that the city had been a little remiss as to Jackson street, and correspondingly zealous as to Twelfth street, and the interview ended with Mr. Purdy promising to write the railroad people in the matter at once. When the Jackson street bridge was first talked of, a proposition was pending to keep the street cars off of it, which had the effect to kill it, but the appropriation was finally made. Since then there has been no activity on the subject except on the part of the friends of the bridge in clamoring for it. If the city had pushed the negotiations as it should, there is no doubt but the necessary land would have been secured long ago.

The North Chicago City Railway Company has a large force of men at work preparing the old barns on Clark street for the cable machinery, but it has not as yet accepted the tunnel ordinance. There are various rumors in reference to the delay about the tunnel, one of which is that the company proposes to confine the cable system to the North Side, and another that it is waiting for the council to meet, when it will ask that the tunnel ordinance be so amended as to have the land damages at the bridges adjusted by the city as a condition of its acceptance. These reports are given for what they are worth, but the facts probably are that the company has been unable to get the property owners at the bridges, on account of non-residence or absence from the city, to agree to relinquish all claims growing out of any change of present grade. This is known to be the condition on the north side of the river at Clark street, but on the south side it is contended that the city owns all of the "abutting property," and has no possible objection to the new bridge. At Wells street there is said to be no opposition, but it has been almost impossible to get an agreement in writing. In the meantime the company is powerless to go forward with the tunnel scheme, hence the delay in formally accepting the ordinance.

One of the gentlemen active in opposing the cable system on the North Side was around making inquiry on Aug. 12, about the future of the project and complaining that nothing was being done. He inquired in vain for information on the subject. The status of affairs appears to be that the railway company has not yet formally accepted the tunnel ordinance or taken any other action in the matter, except that President Yerkes asked, a few weeks ago, for drawings of the approaches for the proposed new bridges, but has never put in an appearance to claim them, though they were completed some days ago. The company, however, has ninety days to accept the ordinance and its own time to put down the cable.

The dispute over the improvement of Indiana avenue, south of Twenty-second street, has been settled, it is said, to the satisfaction of all concerned, and the work will be pushed early in the spring. The street is to be widened by setting back the curbing, and instead of one there will be two railroad tracks, and instead of horse-

power the cable system is to be extended through that thoroughfare. The latter proposition is new to the public, but it was given out by one of the property owners that it was by no means new on the street, for the necessary petitions had been circulated some time ago.

President Yerkes called Aug. 26 in reference to the grade of Halsted street in the vicinity of Willow street, where he is laying tracks. The new grade, it appears, is eight inches higher than the present street level, and laying the tracks to it makes them an obstruction, which he desires to avoid. The question was talked over, and it was finally agreed that, instead of his paving outside of his tracks, he should fill in the space with crushed stone, and grade the same so as to make the crossing of the tracks by teams an easy matter. The street ought to be paved, but the council omitted to order it, and the above is the best that can be done. Mr. Yerkes said to Commissioner Purdy during his call that he would in a few days ask for a permit to tunnel Clark street from the company's old barns to Division street, to put in certain machinery to be used in connection with the new cable system.

Sup't Cregier says the work on the experimental cable, which is being laid in West Lake street, is proceeding satisfactorily, and he expects it will be in working order very soon.

The North Chicago Railway Company notified the department of public works recently that it would commence the laying of its tracks on North Halsted street, between Fullerton and North avenues, which is the carrying out of the project of some months ago of uniting the tracks of the North and West side companies on that street. When the improvement has been perfected a person can take a car at Fullerton avenue and Halsted street, and go through to the stock-yards for one fare—a distance of about eight miles.

The city has an agreement with several street railway managements by which it issues tickets to its employees, which are accepted and subsequently redeemed in cash. The system is quite expensive, and of late has been greatly abused. The tickets are issued in books, and the intention is that they shall be used only during business hours and on account of city business, but it appears that they are being used at all times, and by almost anyone; in other words, there is a suspicion abroad that some of the persons to whom they were given have been selling them, and to correct the abuse an order has gone forth to the companies to take up all of the old books, and in their place new ones are to be issued, of a different color. The order has gone into effect.

East St. Louis.

A charter was yesterday obtained at Springfield for a company with a capital of \$1,000,000 to construct a cable road in East St. Louis.

Freeport.

The city council has granted a franchise to build a street railway to Messrs. Platt & Clinger, of Waterloo, Iowa. They are expected to begin the work of construction immediately.

Jacksonville.

The Jacksonville Street Railroad Company has recently received two new summer cars built at the Andrew Wright works, St. Louis, Mo.

Springfield.

The Springfield Belt Railroad Company has been incorporated. Capital stock, \$10,000. Frank W. Tracey is interested.

* * *

IOWA.

Clinton.

The street car line has cut down fares from 10 to 5 cents.

Ordinances are being prepared for the city council of Lyons and Clinton granting the right of way to J. W. Hartzell, of Moline, Ill., to construct and operate a steam or grip street car line in the two cities. The line, if built, will run nearly parallel with the horse railway.

* * *

KANSAS.

Dighton.

The Dighton & Watson Street Railroad Company has recently been incorporated in Lane county. The directors are G. E. Long, Digh-

ton; A. B. Horton, C. P. Lynn and J. W. Rice, of Ness City, and A. M. Kelsey, of Bizine. Capital stock, \$25,000.

Salina.

Mr. Herrington has the franchise for a street railroad.

Wichita.

The Riverside & Suburban Railroad Company has been incorporated to build a line from Wichita to Riverside, and to operate the same by steam or electric power. Directors, J. O. Davidson, William Innes, H. G. Lee, C. L. Davidson and W. E. Stanley. Capital stock, \$100,000.

Winfield.

The street railway company at Winfield has placed orders in St. Louis for the rails and cars for the new road. About two and a half miles of track will be built this season.

* * *

KENTUCKY.

Owensboro.

George Fletcher and John M. Bass, of Nashville, Tenn., are prospecting in the city with a view to building a street railroad.

* * *

LOUISIANA.

New Orleans.

Sealed proposals will be received at the office of the Comptroller of the city until October 4, for the purchase of the Orleans Railroad, which is already established and in running order.

* * *

MARYLAND.

Baltimore.

The Baltimore and Hampden Electric Railroad Company will soon extend its system over a branch to West Hampden and Sweet Air, which is now worked by horse power. The branch, however, will have overhead conductors instead of a center rail, and the superintendent, Mr. T. C. Robins, reports that the overhead system will shortly be applied to the entire line and the center rail taken up.

* * *

MASSACHUSETTS.

Boston.

The Metropolitan Horse Railroad Company has voted to introduce electric or cable traction, and President Calvin A. Richards will appoint a committee to visit New York, Philadelphia, Chicago, and other places to inspect the working of both systems, and report upon the one most suitable for the long lines of the company. A recent legislative act authorized the use of cable traction.

The Boston Consolidated Street Railroad Company is to be organized by the Highland and Middlesex companies. Capital, \$1,700,000—the aggregate of the capital stock of the two companies.

The West End Street Railroad Company has been organized to build a line extending from Marlboro street, through West Chester Park, and Beacon street, to Chestnut Hill avenue, Boston; with branches from Beacon street through Washington street to Harvard Square, Brookline; and to Cambridge street, Boston; and from Beacon street along Harvard street to Allston station (Boston & Albany R. R.). The length of the line will be eight miles, and it will be laid to standard gauge. Capital stock, \$80,000. Henry M. Whitney and Charles U. Cotting, of Brookline; Ezra H. Baker, Wm. D. Forbes and H. D. Hyde, of Boston; and Isaac T. Burr, Newton; Asa P. Potter, Cohasset, Mass.; Grenville T. W. Braman, Cohasset, Mass.; James H. French, Gloucester, Mass., are the directors. Besides the directors, these gentlemen have subscribed for stock: Jarvis D. Braman, M. F. Dickinson, jr., Grenville D. Braman, Elmer P. Howe, N. W. Jordan and Dwight Braman. There are 800 shares of stock issued, 375 of which are owned by Mr. Henry M. Whitney.

The reports that reach us from Boston are conflicting on the subject of the proposed consolidation of the Highland and Middlesex street railways.

Full River.

The Globe Street Railroad Company is making rapid progress. A double track will be laid on Bedford street instead of a single one, as originally intended. The company has been authorized to extend its tracks on South Main street to the stove mill. The rails and switches are now being laid, and then the city will pave the streets with granite blocks.

Fitchburg.

The Fitchburg Street Railroad Company opened its line—3 miles long—on July 1. The directors and members of the city government made the first trip, and a collation was served at West Fitchburg.

Holyoke.

The street railroad company will soon extend its lines from the Beach street depot to Pleasant street, along Appleton street. It will be further extended, probably, on Pleasant street to Fairfield avenue.

Lawrence.

A meeting of the Lawrence merchants interested in the Lawrence & Haverhill railroad between the two cities named was held in the common council room in City Hall on August 12. The plans were shown and many questions answered by Mr. Charles Corliss, of Haverhill, one of the committee having the matter in charge. It was ascertained from one of the gentlemen that the number of shares already subscribed for was 1,462; the number remaining unsold, 533. The capital stock is \$200,000. Considerable interest was developed in the meeting, and several parties agreed to take stock in the enterprise.

Lowell.

The Lowell and Dracut Street Railroad Company has been incorporated. Capital stock, \$15,000.

New Bedford.

It has now been settled that the New Bedford & Fairhaven Street Railroad Company may run its cars on the Acushnet Street Railroad Company's tracks on Cedar street.

North Adams.

The Hoosac Valley Street Railroad Company is using its steam motor where the line runs through a meadow to cut off a mile of the road. The opposition is dying out. An extension to Pittsfield is on the cards.

Springfield.

The Citizens' Street Railroad Company will commence work immediately on the Plum street line to Ferncliff cemetery. It will require from 10,000 to 12,000 feet of oak ties and about thirty tons of rails.

The street railroad company has obtained permission to lay tracks on Walnut and King streets on condition that they lay granite paving between and eighteen inches outside its rails, all macadam excavated to belong to the city.

Taunton.

The Taunton Street Railroad Company is negotiating for the recently granted franchise of the Central Company. It has also applied for permission to lay several extensions.

West Springfield.

The West Springfield Horse Railroad Company has been incorporated. Capital stock, \$20,000. Directors, J. L. Wortley, Mace Southworth, Geo. H. Hill, L. P. Strong, Aaron Bagg and John Dorn. They expect to have cars running in three months. A hearing as to the location will be heard by the selectmen on August 16.

Worcester.

The Citizens' Street Railroad Company's line, from Franklin square to South Worcester, was opened July 29. Four cars were run and no fares collected.

**

MICHIGAN.

Grand Rapids.

The following are the members of the new board of the street railroad company: President, William J. Hayes; Vice-President, L. H. Withey; Secretary, I. M. Weston; Directors, Samuel Mather, J. H. Outhwaite, John J. Shipherd and A. B. Watson. The superintendent is A. Bevier.

Detroit.

A company has been organized to build a street railroad from the terminus of the Congress street line in Detroit, Mich., to the suburban town of Springwells. The road is to be worked by electric motors. Work on the line will be begun at once.

**

MINNESOTA.

Minneapolis.

The Minneapolis Union Railroad Company has elected the following board: President, James J. Hill; Vice-President, A. Manvel; Secretary, H. V. Dongan; Treasurer, E. Sawyer.

St. Paul.

It is reported that Mr. Lowry has placed 80 per cent. of the stock of the St. Paul Street Railroad Company with a syndicate of Boston and St. Paul capitalists. The price paid amounts to nearly \$1,000,000. The franchise gives the company the right to lay tracks on every street except Third, and to extend their system through any part of Ramsey county.

**

MISSISSIPPI.

Vicksburg.

The street railroad company of this city has it in contemplation to operate by electricity. It is tired of mules.

**

MISSOURI.

Kansas City.

The work of condemning the right-of-way for a cable line on South Broadway is now progressing. The proposed line will extend south on Wyandotte street to Fifteenth street, thence to Broadway, and south on Broadway to the city line.

The sale and transfer of the Corrigan Street Railroad stock has been completed. Of the 10,000 shares, or \$1,000,000 of stock, 1,500 are held in Kansas City, 200 are yet unsold, and the balance are held by Boston parties interested in Kansas City property. The following compose the new board of directors: President, Col. Moore; Treasurer, A. W. Armour; Secretary, W. J. Terry; Directors, C. F. Morse, Wallace Pratt, Geo. H. Nettleton and W. H. Holmes. Mr. E. J. Lawless is the superintendent, and Mr. Corrigan will superintend the construction of the cable lines on Fifth and Twelfth streets.

The Metropolitan Street Railway Company has been organized to build and operate street railroads in Kansas City and vicinity. Horse or cable traction to be used. Capital, \$1,250,000.

The war between Kansas City and the Metropolitan Street Railway Company, which was inaugurated by Mayor Kump, has ended. The company refused to pay its car taxes, on the ground that it was operating under its cable franchise, by the terms of which the tax was not due until January. After giving notice, Mayor Kump stopped all the cars on the Metropolitan lines. The company applied for a temporary injunction, which was granted. Both sides yielded a point or two in the interest of harmony. Mayor Kump's original position was that the company should pay all its taxes, amounting to some \$7,500. The company, on the other hand, claimed that the tax was not due until January 1. By the terms of the compromise the city agrees to wait till January 1 for the taxes on the lines covered by cable railway ordinances, the company taking out licenses for cars run on the other lines. While the company has made a concession in this latter respect, it has scarcely departed from its original position. It never sought to evade the payment of the tax, but refused to pay it until it was due. Civil action will be begun against the old Corrigan company to recover the back taxes due from it.

St. Louis.

The bill has been passed granting to the Iron Mountain Railroad Company the exclusive right to build an elevated railroad from the bridge to the Union Depot.

The city has the prospect of a change from horse to cable traction over its entire system. An experimental half mile will first be built.

The St. Louis Cable & Western Railroad Company has negotiated the last \$100,000 of the \$600,000 bond issue for the construction of the

line. This last \$100,000 will be used on the locomotive section of the road.

The St. Louis Cable Car Company are receiving bids from several electric light companies for a 100 incandescent 16 candle, and also 30 candle plant, with all appurtenances for lighting their power house, offices, etc., having decided to use electric light, as they have plenty of power to spare.

**

MONTANA.

Helena.

The work on the Helena Street Railway is progressing rapidly. Two rails were placed in position on the 11th of August, and Master Willie Cannon, son of the President of the Street Railway Company, was honored with the invitation to drive the first spike. After this President Cannon made a few remarks, and thereafter the assemblage dispersed for their homes, the blows of the busy workmen, their successors at track laying, ringing in their ears as they drove off.

Too much praise cannot be bestowed upon Mr. C. N. Cannon, the projector of this road, for his energetic public spirit.

**

NEBRASKA.

Kearney.

The city is to have a street railroad, and will build three miles of track before the end of the season.

Omaha.

The Omaha Horse Car Company has secured a temporary injunction restraining the Omaha Cable Company from proceeding with its construction. By an old act of the Territorial Legislature, the Cable company claims exclusive rights to all streets.

**

NEW JERSEY.

Newark.

The stable of the Newark and Irvington Street Railway Company, at Newark, N. J., was burned August 9; also the car sheds and a few tenements. Fifty horses were burned to death. Total loss about \$20,000.

**

NEW YORK.

East New York.

The East New York, Bay Side and Ozone Park Railroad Company will apply to the Supreme Court, September 6, for an order to assume the name of the Brooklyn Avenue Street Railroad Company.

President Richardson, of the Atlantic Avenue Railroad Company, has received permission to lay a car track on Park avenue, from Washington street to Broadway. The Johnson system of the Cleveland Cable Company will be adopted. The conduit will be only six miles deep and can be put down after the tracks are laid. This system has been recommended by President Hazard. The cable consists of double strands, with cross bars, and the grip is fitted with a cog wheel to engage with the cable.

Flushing.

The Flushing and College Point Street Railroad Company has been organized to build a horse car line from Sandford avenue, Flushing, (L. I.) to the Ninety-second ferry at College Point.

New York.

Suit was filed July 28 in the Supreme Court of New York to vacate the charter of the New York Arcade (underground) railway. The plaintiffs include John Jacob Astor, William Astor, the Chemical National Bank, the Western Union Telegraph Company, the Lorillard estate, Miss Wolfe, the Park Bank, Orlando B. Potter, the New York Life Insurance Company, Elias S. Higgins, Judge Hilton, William D. Sloane, the Methodist Book Concern, J. Pierpont Morgan, James M. Constable, Edward S. Adams and many others, representing over \$60,000,000 of abutting property. They allege that the company's charter long since expired, and that the new legislative act is unconstitutional and void.

Justice Ingraham, of the Superior Court, on Aug. 17, denied the motion made in behalf of Joel W. Mason to make permanent the tempor-

any injunction obtained by him restraining the Chambers Street and Grand Street Ferry Railroad Company from constructing or operating a railroad on that portion of its route running through Madison street from New Chambers to Grand streets, where the ex-Commissioner owns property. The Judge holds that although the Board of Aldermen did not reconsider and vote upon the ordinance giving consent to the building of the road within the time specified in the Consolidation Act after the Mayor had vetoed it, yet its action afterward in passing the ordinance was valid because it had been restrained by an injunction from acting within the specified time.

He also holds that the consents of the owners of one-half in value of the property were given in proper form, although some of the consents were signed by their attorneys and proved by subscribing witnesses, but not acknowledged. The temporary injunction is vacated with \$10 costs to the plaintiff.

New York City.

The Forty-second Street and Grand Street Ferry Railroad Company has filed plans for a new depot and stable on Twelfth avenue, between Forty-second and Forty-third streets. Estimated cost, \$160,000.

The Chambers Street and Grand Street Ferry Railroad Company will hold its annual meeting at its offices, 274-286 Broadway, on September 21st.

The St. Nicholas Avenue and Cross Town Railroad Co. proposes to extend its lines. The extensions are principally between 116th and 131st streets.

New York and Brooklyn Bridge.

The following are the bridge receipts for the month of July: Promenade, \$1,659.05; carriage ways, \$5,429.77; railroad, \$51,091.37; total, \$58,179.19.

When the last car on the Broadway & Seventh Avenue Railroad was run into the stable at Seventh avenue and Fiftieth street early on the morning of Aug. 23, drivers, conductors, hitchers, and stablemen went into the street in a body. It was then publicly announced that a tie up had been ordered on three lines operated by the Broadway & Seventh Avenue Company. Superintendent Newell, who went to the stable soon after four o'clock, was told that the men refused to work under the new schedule of trips. The schedule increased the number of trips to be made by each man without increase of pay and put a number of regular men on the extra list. Mr. Newell said that he had no authority to change the schedule, the rearrangement having been ordered by the company. The men claimed that the new schedule was a direct violation of the agreement made between the company and the men last February, by which the number of working hours had been limited to twelve a day. They refused to take out a car until the old schedule had been put back. As a measure of compromise, Mr. Newell said that he would run the cars on the old schedule for two days, or until a conference could be held with the officers of the company. The men refused to accept this offer, however, and remained on strike. They wanted a permanent arrangement. Mr. Newell then closed the stable and got together a small force of inspectors to take care of the horses.

The 24th of August was occupied in negotiations between the company and the strikers. Riotous demonstrations were also made. A conductor seeking work was brutally assaulted.

The 1,100 employees of the Broadway & Seventh Avenue and Surface Road were paid off Aug. 25. Superintendent Newell has advertised for new men.

Early next morning fifteen non-union men from the extra list of the Third Avenue Surface Road started for the stables of the Broadway Road to apply for work. They were intercepted by the strikers and assaulted and driven away. Master Workman James P. Graham hastened to the stables and ordered the men to refrain from all violence.

The employees of the Belt Line left work at 4 a. m. They complain of discharges on frivolous pretexts and also increasing hours of work with a reduction in wages. The employees of the three roads known as the Forty-second street

lines complain of a new time-table issued Aug. 23. They claim that they will have to work ten hours daily without eating or rest.

On the evening of the 27th of August a compromise was effected, but as soon as the gates of the stables were opened on the evening of Aug. 28, the union men made an onslaught upon the new comers, who were overpowered and driven away. In the fight, Lewis Kochler, one of the new drivers, fell down going out of the depot. He was set upon and beaten until he was unable to speak. In Roosevelt Hospital it was ascertained that his skull was fractured. He is likely to die.

The Broadway road regained its normal appearance on the morning of Aug. 29. The men are all at work, have got their regular runs, and appear to be contented. Under the new arrangement they feel that they are better off than they would have been had there been no strike. They have the old schedule, with the exception that they run only five trips on Sunday instead of six trips as heretofore. They get 25 cents a day less, but then one of the men are laid off, as they would have been under the six-trip schedule. One of the main troubles, the fact that the company would not discharge non-union men who were satisfactory, has been successfully overcome by the non-union men voluntarily resigning. They were brought to take this action by the arguments of the union men, who took every occasion to convince them that it would be neither pleasant nor safe for them to stay at work on the road. All the new men having disappeared, one of the members of the Executive Board of the Empire Protective Association said that he did not think there would be any further tie-ups for the present, though some of the Brooklyn roads are much dissatisfied and are anxious to try to force better terms from the companies. "If, however," he continued, "there is any attempt made to reduce wages on October 1, when the companies may reduce fares to three cents in consequence of the reduction on the elevated railroads, you may look out for war. These last two tie-ups were premature and against the advice and the wishes of the Executive Board, but after the men were out it was our duty to make the best we could out of it, and I am glad to say the men are somewhat better off than they would have been if there had been no fight. We had to work like beavers to keep the thing from spreading. I hope that the next company that wishes to alter its time-table will give its men ten days' notice at least, so that they may have time to make known their objections and avoid a tie-up."

Syracuse.

The Burnet Street Car Company has been incorporated by Le-Grand Sherwood and others, with a capital stock of \$12,000.

The Third Ward Railroad Company is to extend the lines planned, from East Genessee street along Quince, Fifth South, Pear, and Sixth North streets, touching Burnet Park. Total length of road, six miles.

NORTH CAROLINA.

Charlotte.

The city wants a responsible company to build a street railroad, and would grant a liberal franchise to such a company. Particulars may be obtained of the mayor, M. W. Johnson.

OHIO.

Cincinnati.

Construction on the Sycamore Hill cable line will be commenced in the early spring, under a grant made to the Cincinnati Cable Railway Company (incorporated last June). The drafting and office work is now in progress.

The cable line to Cummingsville, under grant to the Cincinnati Consolidated Street Railway, will be built at once, and route 18 will be continued by cable to the same point, via Colerain Avenue. This will give the public two separate cable lines to Cummingsville, each four miles long.

The Committee on Organization of the Vine Street Cable Road, of Cincinnati, has reported a constitution, which was adopted. It provides for an association to be known as the North Cincinnati Cable Road Association, its object is

the construction of a cable road from Fountain Square to Vine street and McMicken avenue, thence up Vine street to Mollitor, thence either to the Zoological Gardens or to Burnet Woods. The amount of admission fees and monthly dues, which were left blank by the committee, were filled in at the meeting by twenty-five cents for admission fee and ten cents monthly dues.

A large representation from St. Bernard was present, who wanted it extended to that place, and agreed to co-operate with them. The following officers were elected: J. J. Abbihl, President; John Fehrenbach, Vice-President; A. D. Rover, Secretary, and Wm. Schneider, Financial Secretary. The trustees were elected as follows: Messrs. George Gerke, A. E. Burkhardt, A. E. Erkenbrecher, W. C. Caldwell, George Moerlein, Thomas G. Hickman, W. A. Hopple, Adolph Pluemer, and Henry Knorr. They will also act as an executive committee and employ men to canvass the property holders for subscriptions for the right of way. The following gentlemen will act as incorporators of the road: Messrs. George T. Dieterle, John Van, Sr., W. A. Hopple, F. J. Ahlers, Thos. Bishop, W. A. Gray and John Finn.

Cleveland.

A judge by way of a reminder was given the Broadway & Newburg Street Railway Company by the Board of Councilmen Aug. 2. The property owners, who urged the building of the viaduct, based their plans upon the idea that the railroad would run over the bridge, and give them quick and comfortable transportation to the city. The company also worked hard for the bridge, appreciating the advantage of being no longer compelled to run up and down the long Broadway hills at the Standard Oil Works. The first cloud upon the clear sky of the company's prospects was the difficulty in obtaining the right of way through Davies street, the southerly approach to the bridge. The company were willing to pave between their tracks, but the property owners demand that for the privilege of passing through the street, pavement must be laid from curb to curb. The company are unwilling to do this, and the affair has been at a standstill for several months. A solution of the problem now presents itself to the company in the street that is to run from Davies street, at the end of the bridge, to Forest street, which was strongly urged for the location of the southerly approach. The company hope to be able to pass through the new street at a moderate expense. But on Aug. 2, the Councilmen demanded that the company declare whether or not they would accept the right of way through Davies street, as it is necessary for the city to begin the paving if the company will not. The northerly approach of the bridge will be by way of Pittsburg street. The property owners of this little thoroughfare are enterprising, for they have sent in a formal declaration that they will not give the right of way unless the company will pave the street from curb to curb. Superintendent Stanley, of the company, has made the statement that if the railroad cannot pass over the bridge without exorbitant expense it will continue to run up and down the hills as at present.

Engineer Force, Mayor Gardner, and Mr. Morison, of the Board of Improvements, inspected the cobble stone pavement being laid between the tracks of the St. Clair Street Railroad Company, recently. This was in conformity with a request made by president Hathaway, of the street railroad company, on account of the protests of the property owners on the thoroughfare. The members of the board were satisfied with the pavement and the manner in which it was laid.

The property owners on St. Clair street have been endeavoring to prevent the street railroad company from laying cobble stone paving. The case was recently decided in favor of the company, and an appeal will be taken to the circuit court.

Woodland Avenue & West Side Railroad are building two new horse cars, and have recently added 20 horses to their equipment. They recently placed an order of 175 tons 45 lb. steel rails with the Cleveland Rolling Mill Company.

Limd.

The Street Railroad, Motor and Power Com-

pany has been incorporated with a capital of \$50,000.

Springfield.

The Citizens' Street Railway Company, Springfield, Ohio, will construct a line on East High street to East Springfield; and another on North Plum street to Ferncliff cemetery.

**

PENNSYLVANIA.

Allegheny

Is to have an electric street railway on Federal street, beginning at the city market house, running up Federal street to Perrysville plank road, and on that to the second toll gate. The directors in this company are: O. P. Scaife, President; Arthur Kennedy, Secretary; Wm. Thaw, Jr., J. B. Scott, J. A. Parke and C. Caldwell. It is the intention to extend the line to the corner of Market and Liberty streets, Pittsburgh. The name of the company is the Observatory Hill Street Railway Company.

Oil City.

The city wants a street railroad down Spring street.

Philadelphia.

Henry Root, of San Francisco, Cal., has filed a bill asking that the Philadelphia Traction Company be restrained from infringing on his patented gripping and carrying apparatus. The invention is in use in Chicago and elsewhere, and it is claimed that the Traction Company has no authority to use it. An injunction and accounting of profits is asked for.

Pittsburgh.

The Allegheny County Motor Company has applied for a charter to build and operate electric cables, motors and other appliances for electric railroads. Several electric street railroads are projected for the city.

An electric railway is to be constructed on the south side. The route extends from South Thirteenth street to Mt. Oliver, passing through Allentown and Knoxville. The total length of the route is two miles, with grades up to 14 feet in 100 feet. The parties at the head of the enterprise are: Thos. Evans, President; Henry Stamm, Treasurer; James W. Patterson, Secretary. The company is named the Pittsburgh, Knoxville & St. Clair Street Railroad Company.

It intends to run five motors simultaneously, so as to start a car every five minutes.

The Second Avenue Street Railroad Company has been granted permission to build a line from Grant street along Third, Ferry, and Fourth to Water street, with a branch from Ferry on Fourth avenue to Grant street and Third avenue, and a branch on Market from Third to Fourth avenue. The single track lines are to be laid within and parallel to the present tracks. Horse, cable or motor power may be employed.

Scranton.

The Scranton Suburban Railroad Company has let a contract for 2.75 miles of road with an electric equipment to the Van Depoele Electric Manufacturing Company. The cars will be built by Pullman, under the Van Depoele Company's directions.

**

RHODE ISLAND.

Pawtucket.

Track-laying has been commenced on the new street railroad, and the car shed and stable is being built.

**

TENNESSEE.

Clarksville.

The Madison Street Railway, of Clarksville, is completed; it was said that the people were too poor to ride, and that the scheme would never pay; as it proves, however, the cars can hardly run fast enough to accommodate the traffic. The line was commenced six months ago, and extensions are projected.

**

TEXAS.

Marshall.

A street railroad company has been organized by Chas. Cobb, W. L. Cobb and G. A. Ginchio.

**

VIRGINIA.

Danville.

A company has been formed to build a street railroad. Captain Robertson may be applied to for information.

Richmond.

The Street Railroad Company has petitioned for authority to extend its line on Ninth street to

Leigh and Brook avenue, and for its terminus on Main street to the corporate limits.

Hampton.

A street railroad is projected from this city to Old Point Comfort.

**

WISCONSIN.

Janesville.

The street railway at this place is about completed.

Business Notes.

MR. JOHN O. MAYNARD, of 12 Cortlandt street, New York, is representing the Ober Car Ventilating Co., whose system for ventilating passenger cars on steam surface and elevated railroads, is described in this issue.

THE Brill Car Company shipped two cars to the Daft Company's works Monday for the purpose of having meters attached, to be used at Los Angeles, Cal.

THE Woodland avenue and West Side Railroad Co. is using the Haycox Door Fasteners on all the new cars they are now building.

STATEMENT of the amounts of the various proposals for engines and driving machinery for cable for New York & Brooklyn bridge.

FOR THE ENGINES COMPLETE.

| | |
|---|-------------|
| William Wright, of Newburgh, N. Y. | \$14,010 00 |
| Dickson Manufacturing Co., Scranton, Pa. | 14,150 00 |
| Phoenix Iron Co., Trenton, N. J., 1st proposal | 17,350 00 |
| Phoenix Iron Co., Trenton, N. J., 2d proposal | 17,000 00 |
| Hewes & Phillips Iron Works, Newark, N. J. | 17,500 00 |
| Southwark Foundry & Machine Co., Philadelphia, 1st proposal | 18,150 00 |
| Southwark Foundry & Machine Co., Philadelphia, 2d proposal | 24,700 00 |
| Southwark Foundry & Machine Co., Philadelphia, 3d proposal | 2,000 00 |
| Buckeye Engine Co., Salem, Ohio | 19,000 00 |
| Fishkill Landing Machine Co., Fishkill on Hudson | 21,300 00 |

FOR REMAINDER OF THE PLANT COMPLETE.

| | |
|--|-------------|
| Southwark Foundry & Machine Co., Philadelphia, Pa. | \$17,836 25 |
| Phoenix Iron Co., Trenton, N. J. | 26,300 00 |
| Poole & Hunt, Baltimore, Md. | 27,815 00 |
| Dickson Manig. Co., Scranton, Pa. | 28,110 00 |

THE Daft Company is in receipt of a great many applications for estimates to equip street railways with its system of electric locomotion.

J. G. BRILL & CO., PHILADELPHIA, Builders of

Railway and Tramway Cars.

GOLD MEDAL For Best Closed Car AT CHICAGO EXHIBITION OF 1883.

GOLD MEDAL For Best Open Car AT NEW ORLEANS EXHIBITION OF 1885.

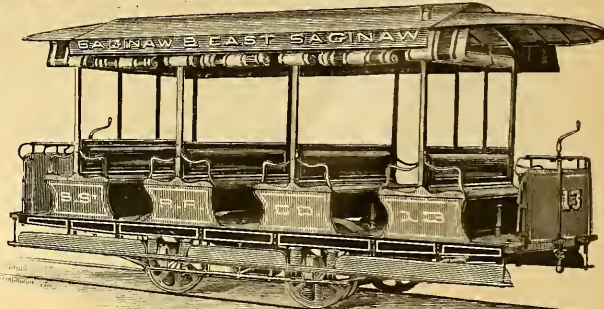

WANTED; FOR SALE; EXCHANGE.

This department has been established as a medium of exchange and bureau of general information, for the convenience of those connected with street railway industries. Street Railway Companies wishing to dispose of or buy cars, appliances or stock, or having contracts to let; persons having vacancies to fill, or wishing situations, etc.; etc., are invited to use this department without charge, being requested only to notify us when the object desired has been accomplished.

WANTED: POSITION.—By a practical Street Railroad man of 10 years experience in the management of employees and office details. Also several years experience in handling money and tickets. Strictly temperate and can furnish best of references from past and present Street Railroad Officers and others. Age 43. Address, S. LAMBERT, 177 Bank st., Cincinnati, Ohio.

WANTED.—A Street Railway, in Nevada, Missouri. A liberal franchise will be given. For particulars, address "Nevada," care of this office.

FOR SALE.—Street Railroad connecting two live manufacturing towns. New road. Population 22,000. Good business. We have exclusive franchise. Address, HORSB RAILROAD, care STREET RAILWAY GAZETTE.

WANTED.—A thoroughly competent Foreman, experienced in the details of street railway construction. Address "A," care STREET RAILWAY GAZETTE, giving experience, references and salary expected.

FOR SALE.—A number of second-hand "bob-tail" cars. Description and price will be furnished on application to "CLEVELAND," care STREET RAILWAY GAZETTE.

*I offer For Sale SIXTY-TWO SHARES
of the Capital Stock of the*
Madison Street Railway Company.

FOR FURTHER INFORMATION ADDRESS

CHAS. F. TUTTLE, MADISON, IND.

Cheap Excursion to Duluth and Return.

On August 10th, 20th and 31st, and September 10th, the Chicago & Grand Trunk Railway will make a round trip rate of \$34.60 from Chicago to Duluth and return, via Ft. Heron and the elegant passenger steamer "Wisconsin," running from there to the Northwest Transportation Company's Line. This rate includes meals and berths on the steamer, which stops at Sault Ste. Marie, Marquette, Ashland, Washburn and Bayfield, giving passengers an opportunity to visit the points of interest at these noted summer resorts, and one day at Duluth. Those desiring may remain at Duluth and return on any of the company's steamers within thirty days. The continuous round trip can be made in about eight days.

CHAS. H. MITCHELL,

Attorney and Counsellor at Law.

Practises in all the Courts. **Railway Litigation a Specialty.** Special attention to Patent Cases and Collections. Prompt attention to Correspondence outside the City. Refers by permission to THE ENGINEERS CO., THE WRIGHT, MONROE CO., and others.

161 La Salle Street, - - CHICAGO, ILL.

Barnum & Richardson Man'g. Co.,
64 South Jefferson Street, CHICAGO.

CHILLED STREET CAR WHEELS
FROM PURE SALISBURY IRON.

Curves, Frogs, Switches, Crossings, Etc.
To Any Pattern.
Light and Heavy CASTINGS for all purposes.

W. H. BARNUM, ALBERT ALLING, WM. E. BEST,
Pres., Lime Rock, Conn. Gen. Mgr. & Treas., Chicago. See'y, Chicago.

HORSE and MAN.

Their Mutual Dependence and Duties.

By the Rev. J. G. Wood, M. A.

Author of "Homes without Hands," etc., with illustrations. 8vo. extra cloth, \$2.50

"Certainly he has written one of the most valuable books on the horse and his proper care that have ever been issued from the press, for it makes very explicit statements concerning conditions that most books of its class fail to treat with anything approaching fulness, while it antagonizes in the most direct and positive manner common practices of the stableman and blacksmith. Some idea of the scope and method of Mr. Wood's book and of his manner of handling his subject may be gained when we say that eleven of his seventeen chapters are devoted to the foot of the horse, its construction, its proper usage, and so on. Mr. Wood not only finds plenty to say about horses' feet and their treatment, but says it very entertainingly; indeed, the book is a remarkable one for its entertaining qualities. It is not only full of information and important suggestions, but it is most charmingly written."—Philadelphia Evening Telegraph.

For sale by all Booksellers, or will be sent by mail, postage prepaid, on receipt of the price by

J. B. LIPPINCOTT CO., Publishers,

715 and 717 Market St., Philadelphia.

The Industrial South, Richmond, Va.

JAMES McDONALD,
BAKER P. LEE, } Editors.

JED. HOTCHKISS, M. E., Editor of Mining and Mineralogical Department.

THE INDUSTRIAL SOUTH is a first-class weekly paper (24 pages quarto) devoted to the Mining, Manufacture and General Industrial Interests of the South. Every business man, North, South, East and West, who desires to inform himself fully as to Southern resources, industries and developments will find it indispensable. Subscription price only \$2.00 in advance.

Advertisers who desire to increase their business relations in new and rapidly developing sections will find this one of the best and most economical means of reaching the substantial and buying classes.

Sample copies 6 cents; rates furnished on application. Address

INDUSTRIAL SOUTH, care of B. F. JOHNSON & Co., Business Managers, 1013 Main St., RICHMOND, VA.

A NEW AND IMPORTANT WORK.

Poor's Directory of Railway Officials and Railway Directors.

The First Annual Number Published in June, 1886.

PRICE, \$2.00 PER COPY.

1 A List of Officials of every Railway Company in the United States, Canada, Mexico, Central and South America, West Indies, Great Britain, etc. 2 A List of Officials of Street Railroads (Tramways) in the same countries. 3 A List of the Directors of all Railway Companies and Auxiliary Companies in North America, alphabetically arranged, with their addresses. 4 A List of the Officials of organizations auxiliary to the Railway System—such as East Freight Lines and Transportation Companies, Bridge and Union Depot Companies, Packet, Steamship Companies, Parlor and Sleeping Car and Equipment Companies, Express and Telegraph Companies, etc., etc. 5 A List of the Officials of Industrial Enterprises dependent on Railways—such as Locomotive, Car and Bridge Builders, Mill Mills, etc. 6 A List of Officials of leading Exchanges and Commercial Associations throughout the country. 7 A List of the leading Contractors of the country, whose speciality is the construction of Railways. 8 A List of Officials of new Railways now in progress. 9 An Alphabetical List of the Officials of all American Railways, with convenient system of reference showing the lines with which they are connected, and other interesting features now first presented in any publication.

H. V. & H. W. POOR,

70 Wall Street, New York City.

AUGUSTINE W. WRIGHT,

Consulting Engineer.

HENRY RAEDER,

Architect and Engineer

SPECIALTIES:

**Plans for Stables,
Car Houses, Etc.**

Specifications therefor and for track laying. Having had many years experience in these special branches, we solicit correspondence with Street Railways proposing to build.

Address, Room 7, 185 Dearborn Street,

CHICAGO, ILLINOIS.

Anti-Fever Medicine.

A SAFE and CERTAIN

Remedy for all Diseases of an inflammatory character in

Horses & Cattie.



Send for Pamphlet containing

Testimonials.

Samples FREE upon application and

Mentioning this Paper.

Dr. William Somerville & Sons,

127 ERIE STREET,

BUFFALO, N. Y.

The Street Railway Gazette.

VOL. I.

CHICAGO

OCTOBER, 1886.

NEW YORK

No. 10

G. B. Kerper.

G. B. Kerper, president of the Mt. Adams & Eden Park Inclined Railway, Cincinnati, Ohio, was born at Reading, Pa., August 20, 1839. Attended the public schools of that city, because he was compelled to. At an early age he regretted that he had been born, but, being here, he concluded to stay and make the best of it. Since then he has been continually getting his full share of the good things of this world, and has not been averse to sharing them with his friends and his family.

He enlisted during the war as private in Company A, 128th Pennsylvania Volunteers, was not well pleased with his situation, and was promoted to the position of quartermaster-sergeant of the regiment, attended faithfully to his duties—the pleasantest duty he had to perform was on the eve of battle when ordered to the rear. At the battle of Chancellorville he captured General Slocum's headquarters team, and, after relieving it of two demijohns of whisky, he kindly permitted the driver to proceed. For this service he would have been promoted had General Slocum known to whom he was indebted for the relief. The driver of the team was elevated to the ranks, sent to the front, and died a hero. The demijohns, marked General Slocum, 12th Army Corps, can be found in the Rapidan, a short distance below the ford where the 12th Army Corps crossed at the close of the engagement. At the close of the war, Mr. Kerper went into the tanning business in Fulton County, Pa. In the winter of 1874 and the spring of 1875, he visited England, France, Austria and Russia, in the interests of the Pennsylvania Tanners' Association. In July, 1875, he took an interest in the Mt. Adams & Eden Park Inclined Railway, and has since then been president of the company. The Inclined Railway connecting Mt. Adams with Cincinnati was completed in March, 1876. The Eden Park Railway was completed in 1878.

The company purchased the Walnut Hills and Cincinnati Street Railroad in 1882. This road, four miles in length, has just been changed to the cable system, and is now in successful operation. Pending the legislation for the right to adopt the system on this route, Mr. Kerper

addressed the following letter to the Board of Aldermen, and it had the desired effect.

TO THE HONORABLE BOARD OF ALDERMEN,
Cincinnati, Ohio.

GENTLEMEN—For the past three months we have had pending in your Board an application from our company asking permission to extend the Gilbert avenue cable line to Fountain square via Sixth street, instead of by Fourth street, or by double tracking Fifth street, both of which rights we now have. Had your honorable body acted promptly on this matter, in accordance with the wishes of the property-owners on the line of the proposed change, and in accordance with the wishes of the patrons of the line, we would have had in operation a complete cable line to Fountain square before the winter set in.

Appreciating the wisdom of your action, I now, in behalf of our company, most respectfully withdraw the application. The people and companies having enterprise are becoming reckless and extravagant in their demands, and must be curbed. Hundreds of them are laying out subdivisions and planning to improve them by seeking legislation to permit them to build drives and avenues, thereby increasing the tax duplicate and giving employment to thousands of idle men. They, like ourselves, are checked in their wild career, as you, in your far-seeing wisdom, justly discriminate and make it a rule that nothing should be done to-day that can be done by the next generation. Those who are idle must wait for work. The people who want rapid transit have ample time in these dull days to linger on the road, and our company, in its reckless desire to extend the cable system to the city, not only must, but can wait.

I am heartily in sympathy with your action, and believe it will result in much permanent good at an early date. Your conservatism is worthy of the ruler of a hamlet, and if strictly adhered to we will, in a very short time, be able to contract ourselves into a space so small that it will only take a few thousand feet of timber to fence the city in. A guarantee fund can be raised on this point. I will head the list. With much respect, yours very truly,

G. B. KERPER,
President Mt. Adams and Eden
Park Inclined Railway.

P. S.—These compliments are not intended for the reckless minority, who favor all improvements, regardless of discrimination.

The foregoing sketch was written by a gentleman who has had a more continuous and intimate acquaintance with Mr. Kerper than any person living; hence the facts rehearsed may be safely received as truth in every particular. As truthful chroniclers of the history of men who benefit humanity by their life work, who add to the wealth and prosperity of their generation by their energy, enterprise and far reaching sagacity, we desire to say that no man more enjoys the confidence and esteem of his fellow citizens than the subject of this sketch. Cincinnati is indebted to him for



G. B. Kerper

a system of rapid intra-mural transit that has made it possible for the business and working people of that city to enjoy the health and pleasure incident to a residence upon the elevated ground known as Walnut Hills. To Mr. Kerper are they indebted for the cable road, and we predict that this enterprise will not end his career as a benefactor of that city. We shall look confidently to see him inaugurating other and larger projects having for their object the dispersion of a rapidly growing population over territory that only needs the enterprise and skill of men of this kind to permit cities to grow and avoid the ills incident to crowded, ill ventilated, unhealthy homes for those who help on the great movement which distinguishes this century.

Mr. Kerper is in the prime of life, healthy, robust, and is equipped with a head capable of quick, correct judgment, untiring energy, and is known as one who never fails, and is recognized as a successful, honorable business man.

Cheap Fares to Healthy Localities.

Any one who would make a tour of the upper end of Manhattan Island would be astonished to see the improvements made along Madison and Fifth avenues, in the vicinity of Lenox hill, Seventeenth and Eighteenth streets. Rapid transit facilities have made habitable those parts that were mere wildernesses only a few years ago. Houses are not only being erected for the accommodation of the rich, but habitations are being prepared for the workingmen and wage earners in more salubrious and accessible regions. There is

Cable Construction of the Mt. Adams and Eden Park Inclined Railway.

The Mt. Adams & Eden Park Inclined Railway Company, of Cincinnati, was incorporated in 1874; the work of constructing a passenger incline began early in that year, and was completed and put into operation in March, 1875. The same year the line known as route 15, connecting the incline with Fountain square, was completed.

In 1877 the company secured the grant for building route 16, known as the Eden Park Route, connecting the incline with Walnut Hills. This line was completed in the spring of 1878. It is beyond question the most attractive street railway route in the world, running at an elevation of 300 feet above the level of the city for a distance of over a mile through Eden Park, affording a series of beautiful views of the city and suburbs and the Kentucky Hills.

In 1879 the demands of the public were such that the company determined to change the incline from an ordinary passenger incline to one that would carry both horses and cars, so as to enable them to operate the line without change between Fountain square and Walnut Hills. This work required an entire change in the machinery and construction, and necessitated the shutting down of the entire line from October, 1879, till May, 1880, and an expenditure of over one hundred thousand dollars. In January, 1881, the company purchased the competing line known as route No. 10, *i. e.*, the Gilbert Avenue & Walnut Hills line.

In 1885 the traction on the hill division, a mile and a half in length, was changed from horses to cable, and oper-

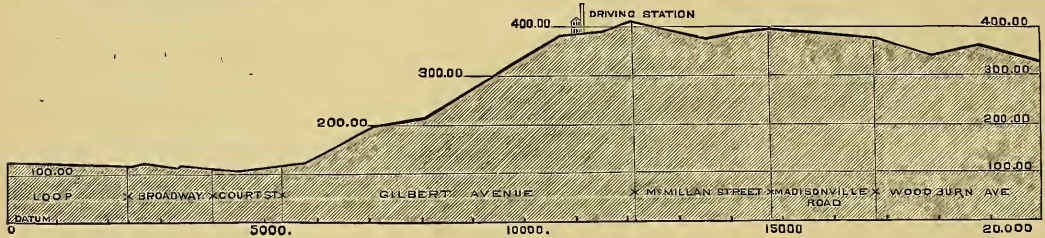

no cessation to those improvements, which constantly creep northward. The elevated roads have been a potent agency in opening up this part of New York and in giving the first impetus to this development, but the Tenth avenue cable road and the new Boulevard surface road greatly increased the movement after it had once been commenced. It is to be hoped that all the "L" roads will see that it is in their interest to reduce the fares and this way complete the good results already worked by the rapid transit system in building up the west side of the American metropolis. At the present rate of building, every lot south of 155th street, from the East to the North River, will be covered inside of ten years. In the absence of rapid transit this section would not have been built up in fifty years. While these forces are operating on the south, the new bridges are developing the city on the north side of the Harlem, lots which were selling at \$200 now being \$700, and in some instances \$1,000. In the more favored localities farther south lots now bring \$10,000 which would not sell for \$2,000 six years ago. The proposed further reduction of fares has already brought about a marked activity in the real estate market, especially as regards property above Fifty-ninth street. And if the increased facilities in question be accomplished it will prove a great boon to New York, for it would break up the miserable tenement house system and fill up all of the Twenty-third and Twenty-fourth wards with small houses, whereby the physical and moral condition of the masses would be ameliorated almost beyond estimation. If the elevated and surface roads cannot meet the requirements of the growth incident to increased facilities of transit that we have referred to, then an underground road must be built. Let it always be borne in mind that the people want cheap fares to healthy localities.

ated with such good results that the work of changing the entire line into a cable route was begun in April, 1886, and has just been completed. This line, as shown by its profile, in Fig. 1, presents a route with more curves and difficulties to overcome, in its operation, than any cable road in existence; it is nearly four miles in length, and double tracked, except the short loop at the city end. It cost thirty thousand dollars (\$30,000) per mile of single track for street construction, and twenty-five thousand dollars for machinery. The entire work has been done under the immediate supervision of H. M. Lane, constructing engineer, who has made cable traction a special study for several years, and the simplicity and ingenuity of the entire construction is shown in the great work that he has accomplished on this line.

The portion first constructed on Gilbert avenue, having five curves (see Fig. 2), was in operation for a period of fifteen months without change of cable. This of itself shows how perfect the machinery and how complete the street construction. In the completion of the additional five miles during the present year many valuable improvements have been made in the construction. The method of concreting by means of a double and single track machine has made the system of concreting perfect, and enables the work to be done at about one-third the cost of the old way.

The method, as represented in Fig. 3 (the single track machine), is briefly as follows: The skeleton iron work being suspended, aligned and leveled within the trench, a platform about 100 feet long and 7 feet wide is laid crosswise on top of the rails; loose sides, about ten inches high, are held in position by angle blocks; sand, dumped from carts on to this platform, is struck off on top by a gauge board, which leaves exactly the proper depth of sand; cement is then thrown on the sand and struck off by another



FIG. 2.

gauge board, leaving the proper depth of cement. Broken stone is then dumped on top of the cement until even with the top of the side boards, forming a continuous bed 100 feet long, with the materials in layers, and each in requisite proportion without dependence upon the counting or measuring of ignorant or careless men. Two men shovel from the end of this bed into the hopper of the machine, which communicates with a rotating screw conveyor, thoroughly mixing the materials dry, conveying them the entire length of the machine and depositing them on a platform on the track at the rear; they having been properly moistened by a spray of water shortly before reaching the end of the conveyor, all is ready for shoveling into the trench and ramming around the yokes. The bed ahead of the machine is so proportioned as to contain the exact amount of material per running foot required in the trench. Then, as each successive plank of the platform is uncovered, it is drawn out endwise, carried forward, and laid to extend the bed in advance, men at this point being engaged in making it at one end while it is being used at the other. The machine is provided with a simple winding gear by which it and the rear receiving platform are drawn forward continuously as the work progresses without interruption of any of the processes.

Touching the general construction of this (the Lane) system of cable traction, it will be noticed that the street surface presented to view possesses the general features common to all cable roads. The $\frac{3}{4}$ inch slot is in the middle of the 5 ft. $2\frac{1}{2}$ in. gauge track, and the upper surface of the slot rail $1\frac{1}{2}$ inches above the rail head, to insure drainage from, instead of into, the slot. The yoke tops and the extremely neat cast iron carrying pulley curbs, curb covers and grip traps are visible at intervals, the details all being arranged to receive any of the usual forms of paving. It is a rather remarkable fact that on the line no less than five different kinds of paving are used—*asphalt, granite block, wood block, boulders and macadam.* Beneath the surface, however, radical departures have been made with good results, as has been proven after fifteen months' actual

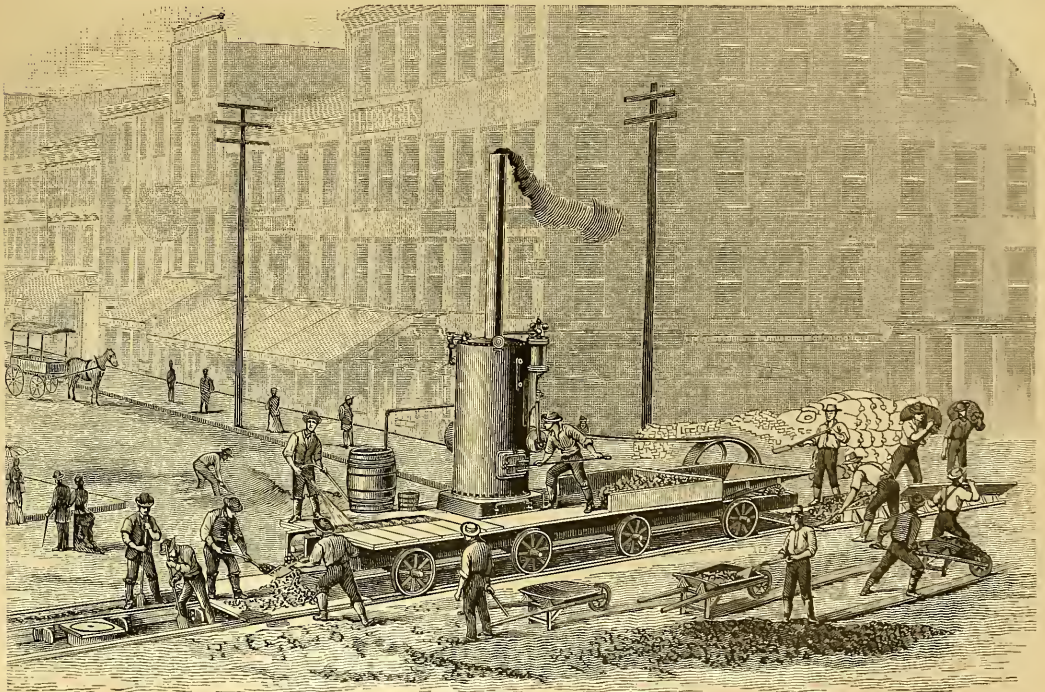

FIG. 3.

experience, during which the temperatures have reached the highest and the lowest recorded by the U. S. Signal Service in Cincinnati, viz., $103^{\circ}+$ and $20^{\circ}-$, Fabr.

The central feature of the underground construction is the yoke (Fig. 4) which consists of a central casting, which supports the slot rails directly and the track rails through the medium of wrought iron brackets or arms. This combination of the two kinds of metal for their respective purposes seems desirable, for while rigidity should characterize the yoke center, owing to the small variation permissible in the slot, the track supports should not be absolutely unyielding, if we would obtain the best results with reference to smooth and noiseless riding. The yoke casting consists of a web of U form, with deep ribs on both outer and inner edges, this form being best adapted to resist the tendency to open the slot by reason of loads on the rails or to closure from frost or traffic pressures. The gap in the casting determines the form and dimensions of the tunnel, the depth being 24 in. in the clear by $8\frac{3}{4}$ in. in width. The notches near the top of both inner edges are provided for the insertion of the narrow dovetailed foot of the slot rail which is keyed therein. Bolts near the extreme top secure the top of the slot rail. The slot formed by the slot rails thus rigidly secured, top and bottom, to opposite inner faces of the rigid casting, has in no instance been known to yield.

It has heretofore been customary to bolt the bottom flange of the slot rail to the yoke and depend upon an adjustable tie to so secure the top as to maintain the desired slot opening. The efficiency of a tie rod depends somewhat upon what it is tied to, and when it is considered that a variation of $\frac{3}{16}$ of an inch on each side of a $\frac{3}{4}$ inch slot would effectually pre-

vent the passage of the ordinary $\frac{3}{8}$ inch thick grip shank, the sufficiency of the track rails for purpose of anchorage may be questioned. When it is remembered that the requirement of rigidity in the fastening of the slot rail exists in connection with the top only, the grip having abundant clearance below the slot edge of the rail, the superiority of

extending the main stay, the yoke, to the top of the slot rail and securing the rail rigidly and directly at that point seems evident. In this connection the form of the slot rail (which, unfortunately, is not satisfactorily shown in any of the cuts, but with sufficient accuracy for the purpose in the representation of the right hand rail in Fig. 5) is of interest. The concentration of metal at the top of the rail, in order to provide lateral stiffness where required, and the almost total absence of the usual broad lower flange at the bottom, where stiffness is not essential, will be noticed. The web is not uniform in thickness, but below the bolt, at which point the necessity for the thickness of metal to that point ceases, it is much reduced. The very narrow flange at the bottom is dovetailed, and when keyed into the notch in the yoke, with soft iron keys, costing but seventy-

five cents per hundred, is as secure as if fastened with more expensive bolts, and the metal which would be required in a flange of sufficient width for bolts is saved. A mile of double track road would require four miles of flange in order to provide sufficient width for a $\frac{3}{4}$ inch nut at intervals of 5

feet. The key requires no holes through the rail, but may be used on any portion of the rail coming within the yoke. The substitution of the key is thus shown to save the bolts and nuts, rail flange and the drilling, and to be a real saving, out of all proportion as compared with its apparent

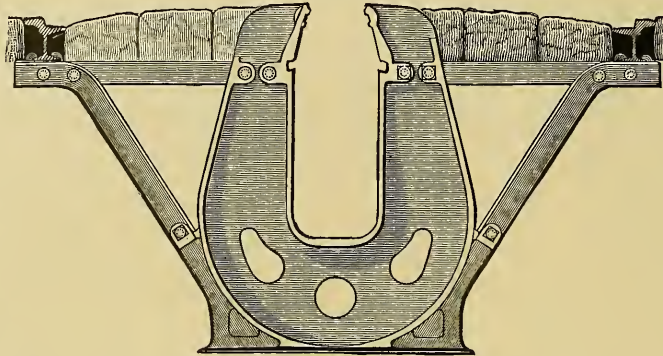

H.M. LAKE CONSULTING ENGINEER.

FIG. 4.

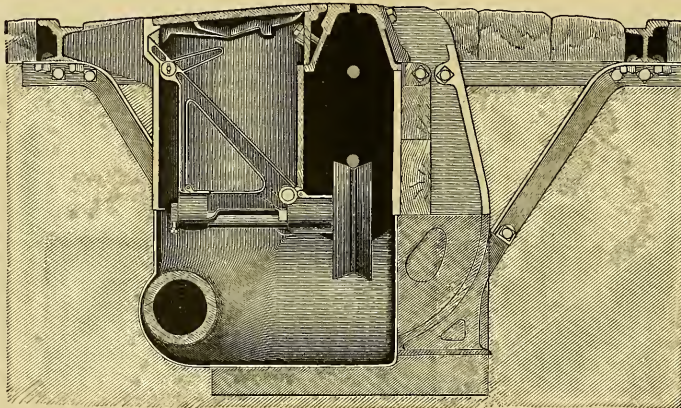

FIG. 5.—CARRYING SHEAVE.

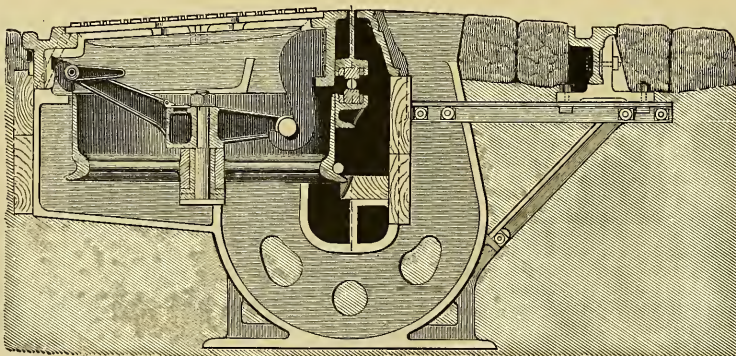

FIG. 6.—THE CURVES.

importance. The wrought iron brackets for supporting the rails are each composed of two members, one tension and one compression. The horizontal or tension member is rectangular in form, and but $\frac{1}{2}$ inch thick, and fits nicely in paving joints; the compression or inclined member is of angle iron, as best adapted for transmitting the thrust of the rail load to the yoke near its base. The strut does not lead to a point directly under the rail, but is united with the

tinued at each side of the gap $2\frac{1}{2}$ inches higher, forming an imperishable water way in the tunnel bottom; the space from the top of the concrete to the bottom of the slot rail is closed with creosoted wood, two pieces being used on each side, each 4 ft. \times 3 in. \times 8 in. There is no constructive obstacle to the use of concrete for the sides as well as for the bottom of the tunnel, but there are several reasons which lead to the conclusion that creosoted wood is prefer-

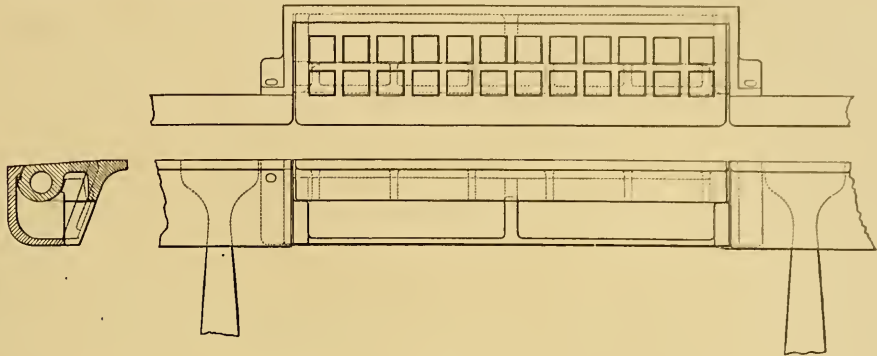

FIG. 7.

tie by rivets slightly within the rail; the rail rests upon the overhanging horizontal portion, which gives a very desirable flexibility to the rail support without encroaching upon the required strength. The 52 lb. Johnson girder rail rests upon and is bolted to the outer end of the bracket with hook bolts, making a cheap, yet extremely strong fastening.

The yokes are imbedded in cement concrete, which extends from a point 6 inches beneath each yoke, up to the bottom of the gap, a total depth of 18 inches, and is con-

able, for there is greater freedom for expansion and contraction of the slot rails than if the yokes were imbedded to their tops in the unyielding concrete, this freedom being of the utmost importance in connection with cast iron yokes. In laying the rails on this road the most delicate means were adopted for accurately spacing the rail joints according to the actual temperature at the time of laying, an ingenious graduated wedge, spacing gauge and thermometer being used. The means employed were so simple and practical that,

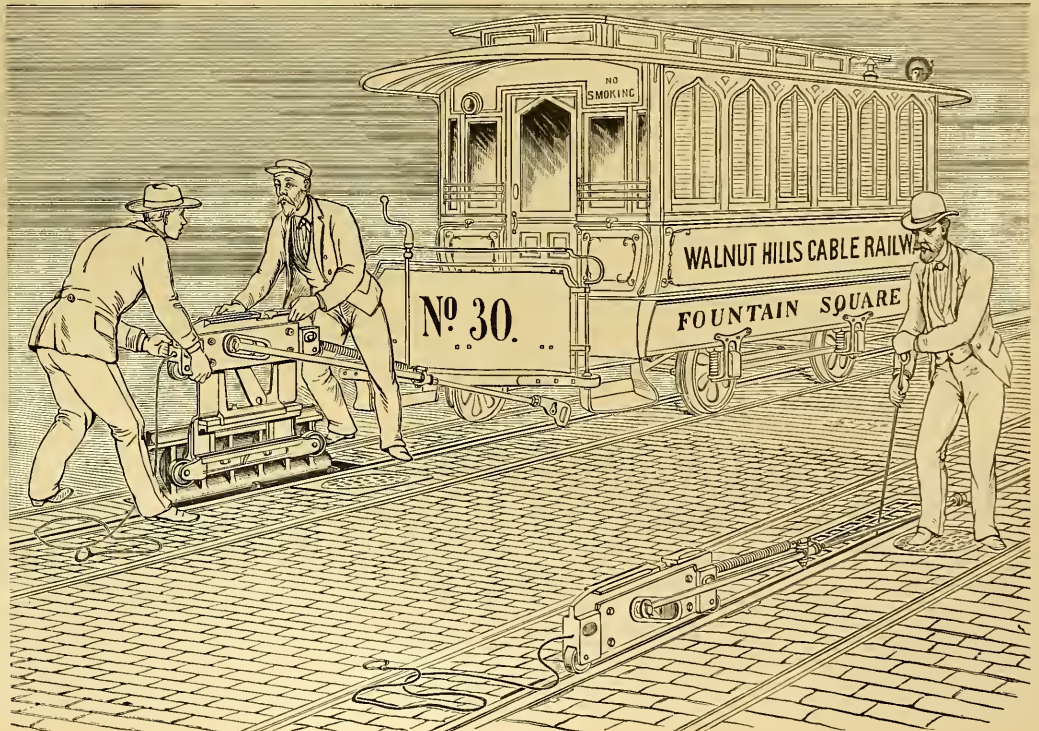

FIG. 8.

although the results obtained were admirable, the cost was inappreciable; secondly, it affords a ready means of access to the tunnel, should that, from any cause, become necessary. By digging 22 inches deep, and lifting out the two pieces of wood forming the sides, an opening 16 inches deep by the distance between yokes is obtained. In other systems the carrying pulley openings are made of sufficient size to admit a man, but are separated by distances of from 30 feet to 35 feet, and, though of ample size to admit a man, they are rather close quarters in which to handle tools, or to perform any very extensive operations; and it is doubtful if, in case of stranding, breaking and wrapping around grips, or other damage so serious as to require access at a particular point, the damage would locate itself, with reference to the access openings permanently provided; thirdly, it is cheaper. This advantage would disappear should it prove less durable than the paving. During re-paving its renewal would be inexpensive.

In systems heretofore constructed, it has been customary to provide a pit or man-hole around each carrying sheave, sufficiently large to admit a workman for the purpose of oiling, adjusting or repairing the sheaves. The arrangement for the purpose designed for this line, shown by Fig. 5, is considered, by those competent to judge, one of the most valuable improvements that have been made in cable construction. The sheave which supports the cable is secured to the end of its shaft, the sheave overhanging, and the shaft being supported in bearings, both of which are on the same side of the sheave, wholly without the tunnel, and both directly under the cover plate, thus rendering them easily accessible for inspection and oiling from the street surface by simply removing the circular cast iron cover, which is but 16 inches in diameter. This is, without an exception, we believe, the only road yet constructed in which it is not necessary to reach over the pulley

slot and lift and hold the cable from the wheel, the cable meanwhile rubbing through the hook laboriously held by one man, while another gets into a close, filthy hole and removes the wheel. In the Cincinnati device the center on which all the parts rotate is so located that the sheave is guided downward and away from the cable, the pressure of which, when the cam handle or latch is released, is sufficient to throw the whole device around on the center ready for removal. To replace the ordinary sheave, the lifting hook must again be resorted to, while, with the improved device, the sheave is swung, guided always by the center up

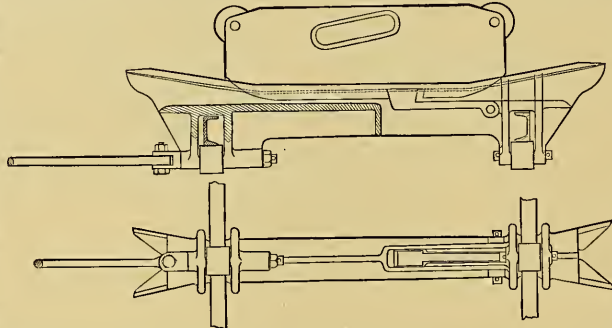

FIG. 9.

under the cable in its deflected position, owing to the removal of its support, and gently raises it to its proper position, when the frame is locked by a trifling movement of the cam handle, all of which may be accomplished by one man. In this simple manner, without a tool of any description, every movable part connected with the cable support may be removed and, if necessary, a new one inserted in a fraction of a minute, and with no part of a man, excepting his hand, going below

the street surface.

This device is contained in a circular cast iron curb, open on the tunnel side, with a cast iron cover on top and a catch basin of the same metal on the bottom. The catch basin extends considerably below the bottom of the tunnel, and thus serves to collect the sediment at points from which it may be readily removed; and it is in connection with the removal of this sediment, and that scraped from the tunnel bottom, that the removable carrying sheave has proved desirable beyond expectation. With the cover and sheave removed, it becomes a simple matter to remove sediment and scrapings with scoops of large capacity, and therefore quickly and cheaply. These catch basins, extending below the general grade of the tunnel bottom, require supplemental drainage, which is obtained by a 6-inch pipe extending from

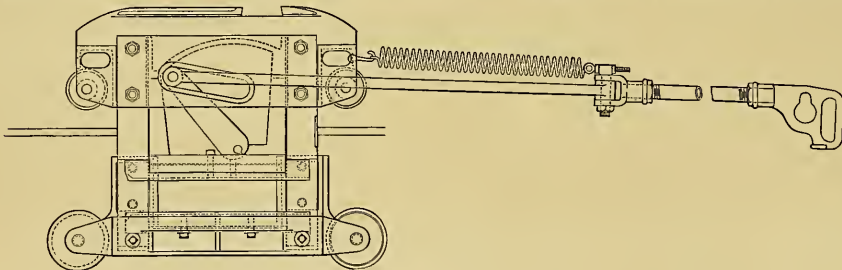

FIG. 10.

and running cable to oil or otherwise attend one of the two bearings supporting the sheave. This arrangement will commend itself to those who have had experience with former arrangements. Should it be desired to remove the sheave, a slight pressure of the hand releases the cam handle near the top of the triangular frame, when the downward pressure of the cable on the top of the sheave causes the frame or hanger to rotate on a center shown to the left of Fig. 2, and slightly above the center of the sheave and carrying sheave shaft, and boxes together until the sheave is horizontal and immediately below the 16-inch circular opening, through which all may be drawn out. In order to remove the ordinary carrying sheave, owing to the cable resting on its top and pressing the cable and its shaft downward in the boxes, it is first necessary to insert a hook through the

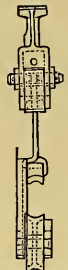

FIG. 11.

catch basin to catch basin, all along the line, with a sewer connection in each depression. This pipe leads into one side of the basin and out of the other, there being, therefore, a break equal to the width of the basin at each sheave; this is very desirable, as there is at no point a greater continuous length of straight pipe than 32 feet to become obstructed; there are catch basins for the drain pipe at intervals of 32 feet, and by removing a cover at any point the flow of water may be seen into the catch basin from the pipe on one side and out of it on the other, and any obstruction definitely located; when having but 32 feet of straight pipe, open at both ends, to deal with it may be removed without difficulty.

A glance at the map of the line (Fig. 2) will show that the great amount of labor expended in simplifying and perfecting the curves was justified by their number, there being

more of them than on any line or system in the world, viz., thirty single track curves in $3\frac{1}{4}$ miles, twelve of which are practically right angles. We will describe the peculiarities only, all of which are shown in Fig. 6; the first is the substitution for the ordinary steel slot rail on the inside, of a cast iron rail somewhat deeper and with a vertical inside face, which rail answers perfectly four different requirements peculiar to the inside slot rail on a curve. First, it forms one side of the slot; second, the vertical face serves most admirably for a grip guide, which is necessary on all curves, owing to the horizontal force exerted by the cable at these points; third, a recessed seat in the upper left hand corner supports the curve pulley cover, making a neat flush finish with top of slot rail; fourth, the flange projecting to the left at the bottom supports a hook, in which one end of the curve pulley hanger rests, and in which it revolves, the curve pulley

lower right hand view of Fig. 8 represents the trap closed, with the grip resting on top of the slot rail, while the operator is represented just in the act of inserting his hook to raise the trap, for its removal. In the upper left hand corner the open trap is shown while the grip man and conductor are represented as just lifting the grip through the opening afforded by raising the trap. This view represents one of the most important improvements in connection with this line, viz., the detachable grip shown by Fig. 10.

A framework beneath the car supports a grip housing or receptacle (Fig. 9), which is provided with all the devices for lateral motion, draught attachment, etc., common to the ordinary grip. Through the housing, from end to end, extends a T shaped opening, with an open slot at the bottom. The top of the grip is provided with a T shaped head, so that when the detached grip rests upon its rollers, on top of



FIG. 12.

and all of its appendages being removable by swinging around a center in the same general fashion as has been already described in case of the carrying sheave. It is only necessary to attempt to remove a curve wheel of the old type, while the cable is running, in order to appreciate removal by simply releasing a latch, or cam, and rotating the wheel and frame on trunions. The cut (Fig. 6), as is usual with sectional drawings, conveys the idea of complication where, in reality, the most rigid simplicity has been attained. In fact, excepting the wheel gear and cover, and a chair under the outer rail, rendered necessary by the Johnson rolled steel curve rail having no lower flange, there are the same number of pieces per section as in the straight track.

One of the neatest bits of design on the road is the grip trap shown in plan, side elevation and vertical cross section, in Fig. 7, and two views, in perspective, in Fig. 8. The

slot rail, as shown in Fig. 8, the T head stands at such a height that the bottom of the car axles will pass over it and it will enter the opening in the housing until, upon reaching the proper point, a heavy latch drops automatically and the grip is secured. All that is necessary then is to hook the handle, shown at the right in Fig. 10, to the lever projecting downward through the front platform, and all is ready for starting. The grip may thus be dropped and pulled from under the car at any point on the line without disturbing the passengers. During the first fifteen months of operation, and before the cable portion was constructed to its terminals, the operation to these points by horses rendered it necessary to convert a horse car to a grip car, and *vice versa*, twice every trip; and this was accomplished by the method of detachable grip just described, the operations having been performed in the neighborhood of 1,440 times

each day. The change from horses to cable has been made without stopping the car, the usual time required being twenty to thirty seconds. Although this feature was designed solely to fulfil the peculiar requirements mentioned, it has proved so satisfactory that it is retained for the convenience of removal in case that becomes desirable.

Neatness of design and extreme simplicity characterize the machinery at the driving station. There are two driving engines, 28 in. X 54 in. (see Fig. 13), on opposite sides of the building; they are of 500 horse-power, and both connected to the same shaft. On this shaft is one pinion for each line gearing, with the main driving gears, one of which is located on either side of the pinion. The rope passes directly around the extended rims of these gears, the usual rope drums being dispensed with. There are but two wheels and one pinion used for driving each line, and the liability to derangement or breakage is correspondingly reduced. The tension carriage is held taut by wire ropes leading to the weights. The winding apparatus being stationary, and not, as is usual, on the tension carriage. The removal of the weight of this apparatus reduces momentum in the carriage and prevents surging. When a chain is used and the adjusting gear is on the carriage, the slack chain must be carried in a box underneath, which, owing to the necessity for oiling the chain, soon becomes filthy. By substituting the wire rope for the chain and winding the slack on a stationary drum, neatness of appearance and perfect cleanliness is obtained. The exterior of the building, which is of brick, is shown in Fig. 12.

The cars are from the works of the Pullman Palace Car Company, and are of the now celebrated Broadway, N. Y., and Passenger Railway, Chicago, type; 16 feet long, cherry finish, center and side lamps, and extra French plate windows, which reach from seat back to car deck.

In the purchase of material for the cable road, local industries were largely patronized, as will be seen from the following list of contractors, whose bids secured the work:

Cast track rails; curve slot rails, pulley covers, grip traps, grips and grip gear for cars; driving machinery; tension apparatus; terminal machinery, elevating wheels, etc.; carrying pulleys, shafts, curves, covers and catch basins—The Lane-Bodley Co., Cincinnati, Ohio.

Yokes—Hoefinghoff & Laue, Cincinnati, Ohio.

Sand—The Cincinnati Sand and Gravel Co., Cincinnati.

Cement and drain pipe—L. H. McCammon, Cincinnati.

Bolts—Post & Co. and L. M. Dayton, Cincinnati, Ohio.

Curve pulleys—Eureka Foundry, Cincinnati, Ohio.

Slot rails—Cambria Iron Co., Johnston, Pa.

Steel track rails—Johnson Steel Rail Co., Johnston, Pa.

Creosoted ties—Carolina Oil & Creosote Co., Wilmington, N. C.

Furnaces—Butman Furnace Co., Chicago.

Pumps—Gordon & Maxwell Co., Hamilton, Ohio.

Engines—The Hooven, Owens & Rentschler Co., Hamilton, Ohio.

Cables—John A. Roebling's Sons Co., Trenton, N. J.

In a recent interview with "the Napoleon of the cable system," a reporter of the Cincinnati *Evening Telegram* becomes eloquent in a description of the cable circuit of eight miles which "runs through one of the most beautiful and thriving suburbs that the sun ever shone upon;" and, in response to his query, President Kerper said that "the excellence of the mechanical part of the work is attributed to H. M. Lane, son of Col. P. P. Lane, of Lane & Bodley.

He is thirty-two years of age, and is a young man of energy and brains. It is to his credit that the city end of the machinery works so well, without a jar or the least obstruction."

In reply to the question, How many people do both routes, ten and sixteen, carry? Mr. Kerper said, "Last year we handled three-and-a-half millions of people. With the increased facilities we expect to exceed over four millions the first year, and even more if necessity requires. There are great expectations in these two lines running to Walnut Hills, and we don't believe the facilities for quick, continuous and cheap transit will be exceeded by any other line in the country."

Street Railway Building.

The enlargement of the street railway service is at present a notable feature of the growth in population and wealth of the more enterprising towns in the neighboring State of Kansas. Certainly at no other time in the history of that State was there ever such activity witnessed in the laying of new lines of street railway as at present. With scarcely an exception, we believe, the flourishing young trade centers in Kansas previously provided with street railways have placed contracts for extensions this year, while at a number of points arrangements have been made for the introduction of the horse car. Wichita may be mentioned among the towns first referred to. Here about three miles of extensions will soon be completed. At Wellington an additional mile of track will be laid.

Winfield will immediately equip her first mile of street railway, to be supplemented during the summer by an extension of one and a half miles. At other towns in the State similar improvements are in progress.

A little nearer home, at Kansas City, street railway construction has assumed the form of a "craze," and large supplies will go forward to that point during the

summer. Between the Union depot and Wyandotte an elevated road will be built, presumably at an early date, as the necessary contracts for supplies have already been awarded. Instead of one, as at present, there will be three cable lines to compete for the city's passenger traffic. The existing cable service will be extended two miles south from Troost avenue to connect with a small steam road, ten miles in length, but as yet unbuilt. The other two lines that have arranged for cables are the Corigan Consolidated and the Grand avenue, both of which are using horse cars at the present time. The first will reconstruct two and the other two and a half miles of double track.

The contract for these various improvements in the street railway lines at Kansas City have already been awarded, and St. Louis has carried off a considerable share of them. One of our local firms in particular has profited to the extent of a quarter of a million dollars in track supplies. At Omaha contracts were also recently given out for two miles of double cable track.—*The Age of Steel.*

WHEN you find yourself wedged in between two old toppers who have been drinking heavily, contrive to breathe as little as possible until a lady comes in, then jump up and offer her your seat. This will be sure to give the impression that you are a polite young man, and at the same time get you out of an unpleasant location.

THE motto of the Socialistic mechanic—Hate hours' work.

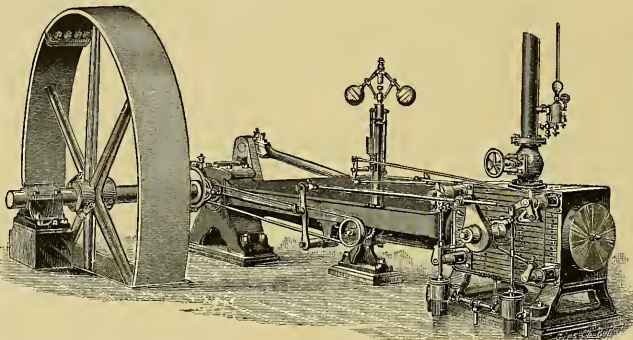

FIG. 13.

THE
STREET RAILWAY GAZETTE

OCTOBER, 1886.—MONTHLY, \$2.00 PER YEAR.

COPYRIGHTED OCTOBER, 1886.

PUBLISHERS:

THE WRIGHT-MONROE COMPANY.

Augustine W. Wright, - - - - - President.
E. V. Cavell, - - - - - Secretary.
S. L. K. Monroe, - - - - - Treasurer.

GENERAL OFFICES:

CHICAGO, - - - - - NEW YORK, - - - - - BOSTON.

CHICAGO,

43 LAKESIDE BUILDING.

P. G. Monroe, - - - - - General Manager.
G. G. Minor, - - - - - }
William Hughes, - - - - - } Editors.

NEW YORK,

181 BROADWAY.

Henry C. Lockwood, - - - Resident Editor and Manager.

BOSTON,

198 WASHINGTON STREET.

T. P. Pemberton, - - - Resident Editor and Manager.

BRANCH OFFICES.

PHILADELPHIA, Pa., 24 N. 4th St., A. G. Judd, Manager.

ATLANTA, Ga., Chamber of Commerce Bldg., Wm. Minnigerode.

Manager.

SAN FRANCISCO, Cal., 1322 Pine St., G. W. Fairchild, Manager.

Announcements.

We have been requested to announce that the proposed exhibit of street railway appliances, in the hall of the Burnet House at the forthcoming Convention, is to be held under the direct auspices of the Reception Committee, and that any representations to the contrary made on the part of outside parties are wholly unwarranted. The Reception Committee consists of

John Kilgour, Pres. Cincinnati Consolidated St. Ry. Co.
G. B. Kerper, Pres. Mt. Adams & Eden Park Inclined Ry.
Albert E. Clark, Vice-Pres. Cin. Consolidated St. Ry. Co.
Jas. M. Doherty, Supt. Mt. Adams & Eden Park Inclined Railway, Cincinnati.

Col. H. C. Lockwood, senior associate editor of this paper has assumed charge of our eastern office, 181 Broadway, New York, as resident editor and manager.

Mr. T. P. Pemberton, hitherto our associate editor at New York, has assumed charge of our Boston office as resident editor and manager.

THE entire cable division of the Mt. Adams & Eden Park Inclined Railway (fully described in this issue) was opened up from end to end on Sunday, the 10th inst. and was a complete success. There were only 3 or 4 stoppages during the day, due to minor causes, and President Kerper was highly elated; over 30,000 passengers were carried over the line in the course of the day.

THE North Side cable road, Chicago, will be proceeded with energetically; President Yerkes having formally accepted the LaSalle Street Tunnel ordinance, October 12th, when he and his company were bound by City Clerk Plautz to comply with all the conditions of that important legislative enactment. All the street tracks are to be laid before the work in the tunnel shall be commenced.

THE great storm around the Gulf of Mexico has done serious damage, *inter alia*, to the street railway tracks at New Orleans; the tracks are twisted and out of shape, and carried out of their regular path for many hundreds of feet.

A PETITION was submitted to the Trustees of Hyde Park, Illinois, October 11th, accompanied by an ordinance to grant a franchise to the Consolidated Rapid Transit and Elevated Railroad Company, Chicago, to construct and operate a double track elevated railroad from Forty-second to One Hundred and Twenty-fifth street. The ordinance provided that the road is to be constructed in the middle of the street on substantial wrought iron or steel columns. It must be completed within two years from the date of the passage of the ordinance. The penal bond is fixed in the sum of \$100,000. The ordinance and petition were referred to the Committee on Judiciary with the attorney added. The new road is to be ten miles in length, and will cost \$700,000 per mile, or \$7,000,000 for the entire road.

THE SCANDAL of the Broadway (New York) railway franchise has been a standing disgrace long enough; and it is gratifying to those who have the honor of street railways at heart, to observe that the disgrace in question is being wiped off—slowly, but surely—by the punishment of, at least, one of the boodle aldermen, with some prospect of further prosecutions. The Court of Appeals, on October 5th, promptly confirmed the sentence of ex-Alderman Jachne. We hope that the District Attorney will now vigorously push the cases against the other indicted aldermen, and trust that the offenders will be punished without further delay. As a contemporary well says, it is high time that the disgraceful scandal of the Broadway railway franchise should be finally dealt with as justice would seem to demand.

The Convention.

"The fifth regular annual meeting of the American Street Railway Association will be held at the Burnet House," Cincinnati, on the 20th instant, and following days. Nearly 150 street railways will be represented. What of the other 400? The National Secretary (Mr. W. J. Richardson), has issued a circular desiring "that delegates, so far as practicable, may be in the city on the previous evening, in order that the meeting may commence promptly at the hour named," (10 o'clock A. M.) Matters of great importance, to street railway companies, are to be discussed; which will arise from the reports of the various committees on the following subjects, viz:

"Cause, prevention and settlement of accidents;" "Sanitary condition of street cars;" "ventilation, lighting and care of cars;" "Progress of cable motive power." "Progress of electric motive power." Either of these subjects may be found well worth the most earnest consideration of the street railway kings that are expected to meet in conventional dignity in the Queen City on this occasion; and if the Convention will manage to thoroughly "thrash out" any one of them, this annual meeting will not be in vain.

Even street railways are not free accidents—to begin with. We have before us a case of collision between a street car and a buggy (down in Kentucky). The buggy contained a druggist and his wife, and the latter was thrown under the vehicle; but, just as the horse was about to run away with it, a colored man who had witnessed the accident stopped the horse and rescued the lady from her perilous position.

Another street car collision recently occurred at Lexington, Ky., on a line under the superintendence of Mr. Bert Cross. While a street car was coming down the South Broadway hill, the brake broke and the car ran over and killed the mule, and then ran into another car. The collision injured several persons. Mrs. W. S. McChesney had her arm broken and Mr. Thomas Mitchell was badly bruised.

Chicago, of course, must not be left, when anything of national interest, like this, may be on the tapis; and in the nick of time it furnishes a "miraculous escape." A prominent citizen of the Garden City, Jacob H. Swart, vice-president of the J. M. W. Jones Printing Company, was dragged some distance under a street car, and miraculously escaped instant death. About half past six o'clock, on the evening of October 5th, it appears that Mr. Swart was riding in the front part of a Garfield avenue car going north on State

street. Opposite Bellevue place he jumped off on the west side of the car just as another car was approaching from the north. Seeing him get off, the driver of the south bound car put on the brake, and Mr. Swart straightened himself up with the intention of standing between the cars as they passed each other. In throwing himself back his head struck one of the roof supporters of the summer car he had been riding on, and he was knocked down in front of the car going south. By mere chance he escaped being trampled on by the horses, and after being dragged along by his head and shoulders a short distance by the car-platform was found lying quite insensible, with his neck directly across the inside rail in front of the wheel of the car going south, and so tightly wedged in that the car had to be backed up before he could be released from his dangerous position. Had the car gone a few inches further the wheel would have passed over his neck. The escape was considered marvelous by all who saw it. No blame seems to attach properly to the conductor or driver of either car. Mr. Swart did not signal the conductor of the north-bound car to stop, and the driver of the south-bound car put on the brake the moment he saw the passenger jump off. If the south-bound car had been in full motion when Mr. Swart was knocked down nothing could have saved his life. As it was, he owes his escape to the very vigorous application of the brake in the nick of time by the driver of the south-bound car.

A far more serious—fatal—accident occurred, October 12th, when the head of Isidore Macoladgy, an employé of the Chicago City Railway Company, was cut off by a grip-car on Twenty-fourth street, at the junction of Cottage Grove avenue, Chicago. The man was at work in a hole between the rails. And, about half-past ten o'clock on the morning in question, he raised his head above the surface of the ground, and not being aware of the swiftly approaching cable-car, it suddenly caught his head and tore it from his body. The driver of the car was placed under arrest, and orders were issued to arrest any person found in those holes. That shows great wisdom—after the event. What is wanted is more wisdom to prevent accidents, and it is none to soon for the Street Railway Convention to take the matter into consideration.

Next to accidents, perhaps, the progress of cable motive power may be the most interesting subject at this fifth annual convention of street railway men. No place on earth is more appropriate to discuss this matter than Cincinnati, and no time more opportune than this, when Mr. Kerper has just finished his remarkable cable construction of the Mt. Adams and Eden Park Inclined Railway. And, moreover, the air is full of new projects for the improvement of the cable motive power, as well as electricity. In our contemporary, *The Master Steam Fitter*, it is pointed out that there may be a "soul of goodness in things evil," when speaking of strikes. An illustration is there given of the method of "Scotching" a strike adopted by the great English inventor, James Nasmyth, who, however, came to the conclusion that strikes "have served to stimulate invention in an extraordinary degree. Some of the most important labor-saving processes now in common use are directly traceable to them. In the case of many of our most potent self-acting tools and machines, manufacturers could not be induced to adopt them until compelled to do so by strikes. This was the case with the self-acting mule, the wool combing-machine, the planing-machine, the slotting-machine, Nasmyth's steam-arm, and many others." And the strikes and "tie-ups" which have recently paralyzed some of our street railways have inspired the spirit of invention, which cannot fail to bear lasting fruit, in the near future. Anxious men have done much thinking recently. Even St. Paul's cathedral, in London, originated in a thought—an idea. So did St Peter's in Rome, for the matter of that. And when a number of intelligent thinkers come together, in convention assembled, there is no knowing what may be the ultimate result—no one can tell what new improvements may become matured and perfected by mutual discussion; and we wish this Convention of street railway men all the success that the signs of the times show to be necessary for the security of intramural passenger traffic.

Street Railway Stocks Assessments.

The following is an abstract from the official statement issued October 11th, at Springfield, Illinois, showing the assessments upon capital stock of corporations made by the State Board of Equalization for the year 1886:—

| Name of Company. | Amount Assessed. |
|--|------------------|
| Quincy Horse Railway Company | \$22,427 |
| Cairo Street Railway Company | 1,523 |
| Cairo City Ferry Company | 2,433 |
| Chicago City Railway Company | 373,185 |
| Chicago Passenger Railway Company | 10,392 |
| Chicago West Division Railway Company | 128,512 |
| North Chicago City Railway Company | 191,581 |
| Pullman's Palace Car Company | 243,345 |
| Street's Western Stable Car Line, Chicago | 19,878 |
| Lasalle and Peru Horse and Dummy Railway Co. | 6,000 |
| Citizens' Street Railway Company, Decatur | 3,689 |
| Central City Horse Railway Company, Peoria | 19,532 |
| Fort Clark Horse Railway Company, Peoria | 6,464 |
| Moline and Rock Island Horse Railway Company | 8,267 |
| Union Street Railway Company, Rock Island | 1,000 |
| Springfield City Railway Company | 5,633 |
| Citizens' Street Railway Company, Danville | 1,134 |
| Rockford Street Railway Company | 4,532 |

Defeat, Not a Failure.

Since writing the biographical sketch of Mr. G. B. Kerper, in this number, we have seen the *Cincinnati Enquirer* of September 21st, and learn, with no regrets, that Mr. Kerper has made what some might call a failure. As truth is useful, sometimes, we give the facts of this (so called) *failure*. Mr. K. was induced by over sanguine friends and admirers to become a candidate for the position of vice-president of the Chamber of Commerce, and engaged in the contest, as he would a business transaction. The result might easily have been foreseen; he was beaten, but we deny that it was a failure. As a strong confirmation of this, we reprint Mr. Kerper's speech to the Chamber of Commerce, with its 2,400 members, after the battle.

MR. PRESIDENT AND GENTLEMEN OF THE CHAMBER OF COMMERCE: The speech that I expected to make on this occasion is not the speech I am making now. I am here to-day to pay a tribute to the gentlemen who defeated me in this contest, and to say to you and to them that all honor and credit is their due. I was not selected to make this contest on personal grounds, but believe and feel that I was chosen as the representative of an enterprise which has greatly added to the welfare and prosperity of this great city—an enterprise which will revolutionize the transit between this prosperous valley and the beautiful hill-tops that surround it. To you, gentlemen of the Independent party, I return my sincere thanks for the honor you have conferred upon me as such representative.

To you, gentlemen of the Chamber of Commerce, I extend my hearty congratulations for the men of your choice, knowing that they will honor you and themselves in their respective positions.

To you, gentlemen who, like myself, have met with defeat, we can return to our respective places of business and look for our reward in the sweet by and by. It is enough to say that we have done our duty, and I have no doubt you will indorse my sentiments when I say:

That duty is my first command,
Which I always shall obey.
And, if I jump the traces now and then,
'Tis because I am built that way.

It will be observed that the members are well punished for not electing him; they now must wait a year for "The speech that I expected to make on this occasion." While they wait, and longingly anticipate the sweet by and by, they will learn to be more careful, in the future, how they overlook modest merit or genuine worth.

Franchise without Bidders!

Bids were receivable up to noon on October 4, for the franchise of the Orleans Street Railway, New Orleans, but no offers were made. And the *Daily Picayune* states that no bids will be made under the present specifications. We publish a copy of the appraisal thereof in another column. It is also republished in the local newspapers. The assessment for 1886 against the company is \$61,050, and against the stockholders \$75,550.

History of Street Railways.

I. INTRODUCTION. THE OMNIBUS.

"The vast amount of capital about to be invested in street railways throughout the great commercial cities of this country, renders every information connected with their history and construction a subject of the deepest interest to municipal authorities, to capitalists, and to the community at large." That was written twenty-seven years ago, by a painstaking and efficient street railway engineer. "Street or horse-power railways" had by that time "come to stay" in New York, Boston and Philadelphia—but not without opposition, which was then serious and threatening, although now it looks more amusing than edifying. To-day we have over five hundred street railway corporations in the United States, and additional ones are continually forming.

As it was in the beginning, so it is now—with regard to the vast amount of capital invested, and to be invested; and also concerning the ever present opposition of vested interests. The main consideration, however, is money—"Money makes the mare to go," and the sparks to fly. It is no longer asked whether street railways pay—unless it be to satisfy the curiosity of a newspaper reporter. And then the answer is similar to that given to a representative of the *Chicago Herald* recently, and reported in our daily contemporary as follows:

MONEY IN STREET RAILWAYS.

"An immense amount of money has been made in the street railway business in this country and other countries," said Representative Negley, of Pittsburg, to the *Herald* correspondent this morning in discussing the efforts now being made to secure the right of way for a traction or cable street railway in Washington. "I knew a New York man a few years ago who went to Rio Janeiro and built a street railroad. He borrowed \$50,000 and put it into the pool as his share. A street railroad in Rio Janeiro was a great novelty, and the patronage was enormous, not only from the start, but has continued so. Some time ago the man died. His widow has just sold one-half of the share bought by her husband, for \$50,000, for \$500,000. The other half of the stock was sold for \$1,500,000. The road is known to this day as the 'Bond Road,' because the money raised to build it was all secured by the issuance of bonds. It not only paid up in ten years, but, as you see, made \$5,000,000 besides. I am told by men interested that the street railroads in Bogota pay as high as 30 and 35 per cent. interest on investments. I see that a recent statement of a company there shows that they paid 40 per cent. dividends during the last year, but of course a street railroad in Washington, where there is so much extravagance, and people so generally patronize conveyances, is a very enviable piece of property. I do not think that Washington ought to be cut up any further by these lines, and it does not occur to me that a charter will be granted."

Street railways have paid well from the commencement. The authority of twenty-seven years ago, already quoted, says: "These statistics [which he had collected, of street railways then existing] show that the business of street railways is of steadily increasing importance, and that the enterprise has been, so far, unquestionably successful. The investments have yielded large and regularly paid dividends. even on amounts of capital charged to construction, which was partly consumed in the purchase of imaginary omnibus rights, and other expenses, amounting in total to nearly treble the actual cost for which roads without grading or bridging can now be built."

It may be interesting to compare the expenditures and income of street railways now with what they were over a quarter of a century ago. We will do that, as far as possible, in due course. First, let us glance at the facilities for intramural traveling antecedent to street railways, and the progress (if it is all progress) made since. The lessons admissible from figures may then be more appreciable. But, although the construction of street railways, and their maintenance and operation, have become more feasible and simplified, and although great amounts are no longer advanced to "buy up the omnibus interests," yet preliminary costs are sometimes very great. And, during recent years, street railways have not been confined to the surface, but have in some instances been elevated; and the more recent tendency is to place them under ground. And while this is taking place with the street railways themselves, their financial operations are not always so much "on the surface" as at first.

The idea of a street railway arose naturally from the contemplation of other means of conveyance, particularly the

omnibus—which was the special fore-runner of the street railway car, but which it opposed "tooth and nail."

The invention of the omnibus is indisputably attributed to the author of the "Provincial Letters." Blaise Pascal, after his second conversion, was drawn toward the monastery of Port Royal, where his sister Jacqueline lived (and prayed for him). That lasting conversion took place in the autumn of 1654. During the previous three years Pascal had been allured by "worldly vanities" through his intimate acquaintance with the gay Duc de Roannez, with whose sister (Charlotte) he seems to have fallen in love.

After pulling the Jesuit doctrines to pieces, in the Provincial Letters, Pascal became ill and feeble, and did nothing for the remainder of his life (of which there is any record) beside managing Roannez's omnibuses, which he (Pascal) had invented.

Pascal died in 1662 (August 19), and, as the first English newspaper was started, by Nathaniel Butter, on the 23rd of May, that year, the omnibus originated just at the beginning, or slightly in advance, of the newspaper era.

To be continued.

Street Cars in the City of Mexico.

The District Railway company operates 150 kilometers of track, or about 93 miles English measure. Its rolling stock consists of about 139 first-class cars, 65 second-class cars, 46 platform cars for transporting furniture, merchandise, etc., 26 funeral cars, and 26 wagons for transporting material and fodder. The company owns 1,500 mules, eight estates in the city, and twelve in the suburbs. It transports nearly 10,000,000 passengers yearly. Fares range from 3 to 23 cents, according to distance and class, but in the limits of the city proper the first-class fare is 6¼ cents, or a medio equal to 5 cents American money.

The divisions of the cars into first and second classes will be noted. This is an excellent idea, for people who want good company pay double what those not particular are charged. The first-class cars are painted yellow and the second-class green. These cars run in "trains" of two or three. There is always one first-class and one second-class car in a "train." On long distances sometimes two first-class and one second-class cars are run, and sometimes four cars.

The hours for running cars are from early morning until 9 P. M., and on some lines stopping at 7 P. M. There is no all-night service anywhere.

There are a few short open cars, but the great majority are closed cars, with the windows down, except in cold or rainy weather. Everybody smokes as much as he pleases on any car, from conductor to driver. Smoking is so universal here that a prohibition of smoking would make the people rise in revolt. Sometimes, I regret to say, the conductor has a novel, and reads slyly, to the neglect of passengers hailing his car from the sidewalks. The conductors do not take up tickets, but these are gathered by inspectors, who board the cars at regular stations, and after collection, make a comparison of books with the conductor. This system is said to work very well.

Conductors are paid from \$1 to \$2 per day; inspectors, \$1.50; drivers, 75 cents. Deduct from this 20 per cent. to get the equivalent in American currency. This would make the pay of a driver 60 cents.

The city lines are 14 in number, and there is a system called the "circuit" system—not exactly a belt railway, but a system of narrow-gauge tracks running away through the city, up one block and down another. These lines go east, west, north and south, and really form a useful feature of the system. There are seven narrow-gauge circuit roads.

A novel and very useful feature is that of platform, and even box cars, in which furniture or goods are moved from point to point. Pianos are largely carried in this manner, and costly mirrors and such fragile goods. A platform car, to a point four miles out, costs but \$3 or \$2.40 American money. Six dollars pays for a service to the distance of 12 miles. Not over 7,000 pounds are allowed on a single car. I should think this feature might advantageously be

introduced into the street car service of the United States, especially in cities where the lines are not crowded with passenger cars.

The tourist in Mexico frequently sees, slowly traversing the city streets, black, lugubrious-looking platform cars, and the canopy of the same somber color. This is a funeral car, and following it there will be one or two cars filled with mourners, all on their way to some neighboring cemetery. The coffin is in plain sight on the funeral car. In the case of young children, white cars are used. This service costs from \$4 to \$12 per car, according to the class, and is the usual mode of conducting a funeral here.

Although the etiquette of a Mexican street car is free and easy, and men smoke inside or on the platform, women are invariably treated with respect, and a half dozen men will get up and give place to any women, young or old, rich or poor. The Mexican gentleman has all the courtesy for which the Latin races are famous, and life is smoothed and its angles rounded by the constant courtesy of this most polite nation. Do not imagine that because people smoke in the street cars their interior resembles the American railway smoker—all filth under foot and the air befoiled with rank cigars and old pipes. The windows of the car being generally open, a constant current of air drives the smoke out of the car, and one hardly notices that smoking is going on.—*Cor. Boston Herald.*

Haddox Car Driver's Stool.

Touching upon the present necessity of a car-driver to be always standing, while on duty, it was asked, in the August issue of the *Gazette*, "Why does not inventive genius produce a seat that will relieve the driver of his tiresome position, and, at the same time insure the safety of the riding public?"

The answer comes from a Louisville man, J. O. Haddox, who has an appliance that appears to about fill the bill, and of which the following is a fair illustration:

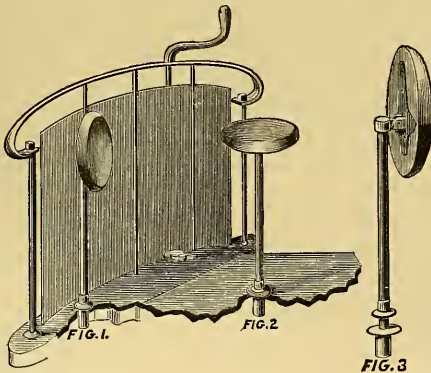

Fig. 1 shows the stool not in use, but folded and placed against the dash out of every one's way.

Fig. 2 shows the stool in position, ready for use.

Fig. 3 shows the stool apart from the car.

The folding up arrangement is for the combined purposes of being kept fairly dry in wet weather, and of being readily put out of the way when not in use. The Louisville City Railway Company have applied it to all their cars—about 212—and both the officers and employés appear to be well satisfied therewith.

Mr. Geo. H. Barbour, Sec., of the Michigan Stove Co., will be on hand during the Convention (in room 22), with two specimens of the Garland Car Heater, and will be pleased to have all the delegates pay him a visit.

R. T. White's "L" Road.

This newly patented elevated railroad claims superiority over all others with regard to safety, durability, economy, and practicability.

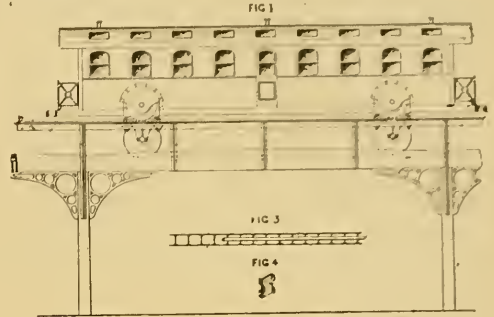

Fig. 1 is side elevation of structure and car, with idle or safety wheels on side of car, with main carrying wheels under idle safety wheels in center of car, as shown in Fig. 2.

FIG. 2.

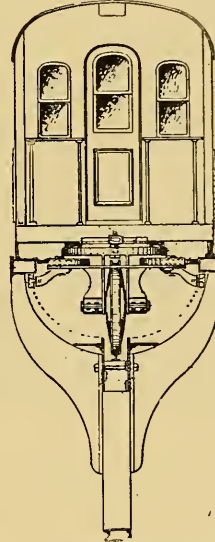

Fig. 2 also shows brackets from main girder to upper rails or box girders; thus binding the whole structure together, "making the same very economical, strong and safe," as declared by the patentee.

Fig. 2 shows end view of structure, with main wheel running over center post, and brackets running from post and main carrying girder, up to box girders under each side of car and on the inside of upper box girders. A small flat rail is to be used, and the inventor has on top and on each corner of truck frame a small wheel to run against small rails to steady and guide the car. There is also an arm projecting from bottom of truck frame out and under box girders, carrying a small wheel, as shown, to prevent the truck from jumping the track.

Fig. 3 shows main carrying box girder and rail looking down; and Fig. 4 shows plate for holding sides of box girders together.

Mr. R. T. White, of Boston, is the inventor of this scheme for an elevated railroad. We have applied for further particulars, for the information of our readers, which the inventor promises to furnish as soon as foreign governments to whom he has applied for patents will issue them. In the mean time Mr. White is constructing a model continuous railway of iron, on his new plan, with parallel sides 16 feet long, and rounded ends about 5 feet long, on which two cars are to run, to demonstrate the peculiarities and advantages of the White "L" road.

It is claimed that cars on this railway will turn a corner of 10 feet radius, as easily as it runs on the straight line; and the switch also seems as simple and safe as possible. It is further declared that the wheels will be noiseless, that the "setting of the posts cannot be beaten," and that the structure and stations can be built of steel for \$125,000 per mile—all ready for rolling stock.

Fig. 3 represents a common rail in center of box girder, on which no dirt, snow, or ice can stop. The wheels on each side of the car are "idle" wheels, and are to be used, in case of a breakage, to avoid any delay or inconvenience.

New Orleans Street Railways and Morality.

The New Orleans City Council have killed two valuable birds at one shot! This warm city is well provided with intramural conveyances. It is, at the same time, troubled with laxity of morals.

On the 14th of September, Mayor Guillotte transmitted to the City Council the following for their consideration and action thereon, namely,

ORLEANS STREET RAILROAD.

The joint report of Appraisers T. S. Williams, on the part of the city of New Orleans, and R. R. Benson, on the part of the Orleans Railroad Company, embodying a detailed statement of the value of the property of the Orleans Railroad Company, as duly authorized by the respective parties in interest.

Inasmuch as the ordinance under which the privileges of the company were secured declares that the property shall revert to the city at the expiration of the privilege, at the valuation of said joint appraisers, I recommend that the specifications under which the new franchise will be sold be so modified by the Council as to require the purchaser to bid in cash the full amount of the appraisement as agreed upon by the appraisers, and in excess of the amount bid for the franchise or right of way as offered for sale.

As certain localities through which lines of cars are constantly passing are occupied by lewd women, whose public and shameless conduct in view of those whose business and home require them to use these public modes of conveyance, and with a view to the suppression of such open manifestations of vice, I would respectfully recommend the police committees of the Council to prepare an ordinance requiring the removal of all prostitutes from streets through which any line of street cars may pass to localities in rear of Rampart street.

Such ordinance when framed should be examined by the City Attorney so that when adopted by the Council it may be free from any legal objection, which might frustrate its enforcement.

Respectfully, J. V. GUILLOTTE, Mayor.

The following is the joint report of the appraisers appointed to value the property of the Orleans Railroad Company:—

The undersigned, appointed by the city of New Orleans and the Orleans Railroad Company, have after a very careful and close examination fixed its present value as follows, viz:

| | |
|--|---------------------|
| 28,005 feet of track on cobble-stone streets, 3415 feet of track on square block streets, 16,944 feet of track on dirt streets, wood tramway, 1020 feet of track in station and car house, turn tables, switches and iron bridge tops, at..... | \$106,258 00 |
| Thirty-two cars at..... | 15,200 00 |
| Sixty-six horses at \$40 and upwards, average \$85..... | 5,610 00 |
| Seventy-six mules at \$50 and upwards, average \$140..... | 10,640 00 |
| One square of ground, bounded by Laharpe, White, Lapeyrouse and Gentilly, with stables, station shops and other improvements thereon, at..... | 26,000 00 |
| Two lots of ground corner Laharpe and White streets..... | 250 00 |
| Office furniture and two safes..... | 454 50 |
| Three clocks, starters, stable watchman..... | 170 00 |
| Total..... | \$164,582 50 |

Respectfully submitted, New Orleans, Sept. 8, 1886.

Appointed by the city of New Orleans: T. S. WILLIAMS.

Appointed by the Orleans Railroad Company: R. R. BENSON

Five days later the City Council had the appraisement of another of its street railways transmitted to it, namely,

CANAL AND CLAIBORNE STREET RAILROAD.

We the authorised, appraisers on the part of the city of New Orleans and the Canal and Claiborne Street Railroad Company, hereby respectfully submit our valuation of the property of the said street railroad company.

0.65 mile track ground into square blocks, 0.42 mile single track in square block paved streets, 5.80 miles wooden tram track, 3.42 cobble-stone track, which stone was furnished by the railroad company, 2.80 miles cobble-stone track in paved streets, 0.05 mile track on iron plate.

| | |
|---|---------------------|
| Total miles 13, 14 at..... | \$99,236 00 |
| Common street car station, shops and appurtenances..... | 30,000 00 |
| Nine lots in square, Banks, Palmyra, Rocheblave and Tonti..... | 1,575 00 |
| Three cars..... | 159 00 |
| Triangular lot Lafayette Avenue..... | 200 00 |
| Lafayette Avenue Station and all appurtenances..... | 25,000 00 |
| 40 cars at \$750..... | 30,000 00 |
| 4 trucks..... | 100 00 |
| 200 mules at \$145..... | 29,000 00 |
| 1100 tons of stone at Lafayette Avenue station, and in lot, Girod near Foucher..... | 1,650 00 |
| Lumber, upper and lower stations..... | 401 00 |
| Old rails, wheels, axles and scraps, upper and lower stations..... | 1,655 00 |
| Stock of feed at upper and lower station..... | 2,596 00 |
| Stock horse shoes and horse shoe iron..... | 511 74 |
| Harness in use and in stock..... | 1,240 00 |
| 2 clocks, 4 Babcock extinguishers..... | 350 00 |
| Grand total..... | \$223,664 74 |

On September 21st this was submitted to the regular

weekly Council meeting, with the Mayor's official report, saying,

Herewith are transmitted for your consideration and action thereon.

1. The report of the City Treasurer for the week ending Sept. 18, 1886.

2. Report of the appraisers on the part of the city of New Orleans and the Canal and Claiborne Street Railway Company, submitting under their individual signatures as appraisers, their valuation of the property of the said street Railroad company, the same in conformity with section 6, article 140, page 426, Jewell's Digest of City Ordinances. Ordinance No. 1805, Council Series, directs that the appraisement thus made be deposited in the office of the Comptroller, and at all times to be subject to public inspection. The same having been referred to your honorable body for information, the Council is requested to direct the clerk to deposit the instrument with the Comptroller, as provided for by ordinances. The recommendations made to the Council in my weekly message of the 14th inst., relative to the joint reports of the appraisers of the Orleans Railroad, applies also to the specifications under which the right of way of the Canal and Claiborne Railroad Company is to be sold, the clauses relative to reversion to the city after the expiration of term of franchise being the same in both instances.

The City Council merely referred the matter to Committee No. 8. Those interested in the street railways in New Orleans have been not a little excited over the franchise of the Canal and Claiborne Street Railroad Company. It was kept too much "in the dark" for a considerable time. The specifications, upon which bids were asked, "were simply kept on file in the office of the clerk of the Council" until the ordinance No. 1805, above mentioned, was brought to the surface. Then matters proceeded more smoothly. "Mr. Collins, the highest bidder, who offers \$54,000 for the franchise, states that he has solid financial backing, but he is not communicative on the subject."

The mayor's recommendation to the police committees, to suppress exhibitions of lewdness, also caused surprise—almost amounting to a sensation, it is said. The general public were under the impression that the public streets belonged to everybody, and that sinners (if entitled to any freedom at all) had as much right as saints to walk along a railway street, or to ride in street cars, upon payment of fares. There is a law, however, which was referred to in THE STREET RAILWAY GAZETTE for June, to protect passengers from painful feelings (as well as from pain to their limbs) and that railway companies are liable to be sued for damages if they permit "the nuisance of indecent language and conduct"—after notice has been given "of any facts which justify the expectation of such wanton and unusual outrage to passengers." In the New Orleans case, the City Fathers, while availing themselves of the general legal provision referred to, expressed (practically) their righteous indignation against a sin which easily besets inhabitants of warm climates, and at the same time (and thereby) they improve the character and enhance the value of their franchise—by anticipation of the moral improvement mentioned.

The Crescent City is well provided with street railways, which are becoming of increased value, period after period. Besides those mentioned, there are the New Orleans City and Lake Railroad, the Crescent City Railroad, New Orleans and Carrollton Railroad, and the St. Charles Street Railway Company. These half-dozen companies, between them, operate 131 miles of road (108 miles being within the limits of the city boundaries), running 527 cars, and employing 489 horses and 1557 mules.

THE manner of stopping a car or alighting from one is often regulated by the person's age or sex. In notifying the driver or conductor that she wishes to ride, the young lady is mincing and undemonstrative; the young man is forward and consequential; the middle aged woman is dignified and firm; the middle aged man is bold and commanding, while old men and women frantically wave all the umbrellas, canes and bundles they can get hold of; and they "look daggers" at the conductor if the car is not stopped precisely to comply with their wishes.

In getting off, the young man alights while the car is moving rapidly, the middle aged man steps down just as the car is about to stop, and the old man waits until the car stands still. Women of all ages are very apt to get off backwards, and are, therefore, subject to falls and accidents.

Hilly Railways, in Cincinnati, Etc.

NEW AUTOMATIC BRAKE FOR CABLE CARS.

In an article on "Inclined Railways and Elevators," *The American Engineer* observes that the word "elevator" has come to be used to designate what might be regarded as a vertical railway. It is the first cable railway. But the cable or rope is not now confined to the vertical railway, prominent examples of which are well known, including various degrees of inclination.

Our contemporary proceeds to enumerate several of such hilly railways, the first mention being concerning the cable construction of the Mt. Adams and Eden Park Inclined Railway, Cincinnati, which we illustrate in this number of the GAZETTE. Such is the official designation of this interesting inclined railway; but it is more often called the Walnut Hills Railway colloquially (Walnut Hills forming the base of Mt. Adams), and still more frequently is it styled the Highland Incline, the Highland House being the rendezvous to which the votaries of wine, beer and merry-go-round amusements resort by means of this popular railway. There are three other

inclined railways in the Queen City, which (partly like Jerusalem) is half surrounded by attractive hills on the tops of which are alluring groves and pleasure resorts, full of altars to the "queen of heaven," and these railways are also named by the "giddy multitude" after the names of the houses to which they lead, viz.: the "Look Out," which elevates

its passengers to the Lookout House, at the top of Mt. Auburn; the Bellevue Incline, which also goes up Mt. Auburn, but inclines towards the Bellevue House; and the Price Hill Incline (the most westerly one). Two of these railways are known by other names by the most devout portion of the community (who do not "lift up their eyes to the mountains"), the Look Out being called the Mt. Auburn Incline, and the "Bellevue" is officially designated the Cincinnati & Clifton Railroad, or the Cincinnati Street Railway.

We need not say any more about the Mt. Adams and Eden Park Incline than has been already stated in this number of the GAZETTE. Concerning the other three "of these inclined plane railways or inclined elevators in the city of Cincinnati, which connect the chief business portion of the city with the elevated lands about it," our contemporary points out that all of them are for people, and have car bodies, like street car bodies, except the Price Hill Incline, which has a set of cars for persons, and a set for freight and vehicles, but not street cars. The length of these inclines range between 790 and 975 feet, and the total rise between 275 and 325 feet. There are also several similar inclines in Pittsburgh.

"In each working system there are two trucks and tracks; one truck descends as the other ascends. Steel wire ropes are exclusively used to pull the trucks. A 'safety' rope passes from one truck up around a safety wheel, and thence down to the other truck. A draft rope or ropes pass from the car to a winding drum, two drums being on a common

shaft, and driven by a duplex steam engine. The safety rope is what its name indicates, in every sense; that is, it takes no part in hauling the cars, and works comparatively slack, the draft ropes being adjusted to take the weight of the trucks, rather than the safety rope, and should the draft ropes fail, the safety rope is for the rescue. The safety wheel is usually provided with brakes, by which, if the trucks should be unbalanced in load at failures of draft ropes, the trucks could be retained in position. This brake is sometimes arranged to be applied by the operator or pilot and sometimes automatically, as is the case with the inclines at Cincinnati.

"The machinery of such inclines should be ample, substantial, and first-class. The motion must be reversible. The drum should have two brakes, one a reserve. A pilot-room should be placed in a position commanding a view of the tracks, the latter being illuminated at night. The machinery and tracks can all be operated by one man in the pilot-room, by levers and pedals connecting by rods with the engine and brakes.

"Experience with these inclined railways has shown that they approach very near to absolute safety, even nearer than ordinary railroads, and yet there remains at least one element of danger which may be avoided. For instance, suppose a pilot should become unaccountably frustrated while the cars are moving on the inclines. This is known to have occurred in at least one instance within the personal knowledge of

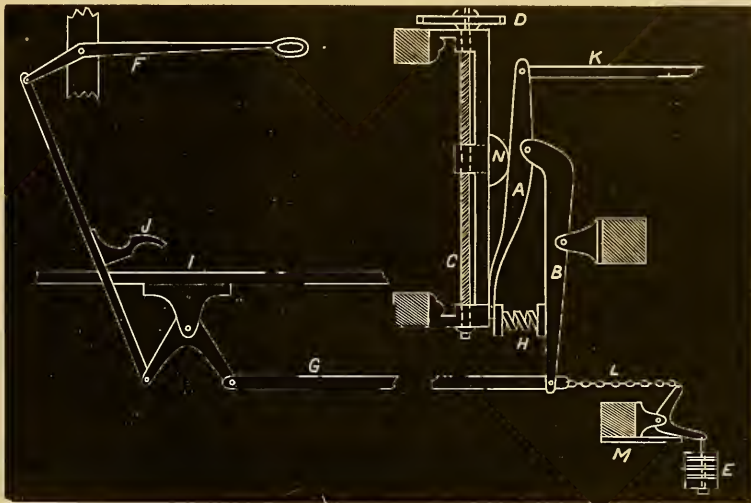

the writer, in which the cars or trucks were thrown forcibly against their stops, when the top one was torn loose and went down with a fearfully accelerating motion and terrific wreck below. Again, it is possible that the pilot might fall disabled from heart disease or otherwise. To avoid serious consequences in such events, it is necessary that the machinery should automatically put on brakes as the cars approach their landings, and stop them before striking. Then, for ordinary stops, the pilot has simply to ease off the excess of brake power in bringing the cars properly to their landings, instead of pulling on the whole resistance for stopping. With such an arrangement all could be done that can now with the brakes, while possessing the greater advantage of automatically applying plenty of brake-power should the operator from any cause fail in his duties." Such an automatic brake appliance is shown in the cut, first published in the Annual Report for 1883, page 152, of the Hon. H. Sabine, Commissioner of Railroads for Ohio, and was invented by Prof. S. W. Robinson, of Columbus, Ohio, who furnished these details to the *American Engineer*, to whom we are indebted for the accompanying illustration of this new automatic brake.

A is a lever which may, at a certain place, be moved by the sliding block N, and so move the brake-rod K.

B is a lever to operate brake-rod by means of treadle J or hand-lever F.

C is a screw moving sliding block (three or four feet long), the block moving one way for the cars, and vice versa.

D shows the gear, which is geared with drum. The screw works sliding block while car moves over inclined track. The sliding block presses lever *A* at, say, 200 feet from landing of cars, and puts on brake. Brake thus put on should be able to stop cars in any case before reaching landing. Then to make landing the excess of brake is eased off by pilot.

E is a knife keeping spring *H* stretched.

F is a hand-lever to operate brake. To apply brake any time, lift up this lever or press down pedal or both. When sliding block applies too much brake, push down on this lever to ease off the excess of automatic brake, and thus bring car gently to landing.

G is a stiff rod, for tension or compression.

H is a spring, which is simply to make brake work easier. Unless of proper strength and yielding capacity it will not work satisfactory.

I is floor of pilot-room.

J, pedal to aid in applying brake any time.

K, rod to brake.

L, chain connecting weight *E*.

M, stop arresting action of weight *E*.

N, sliding blocks, which may, if desired, be made to cut off the steam at the desired point.

This system of levers and screws may be in any position, according to convenience; one for each track. Or one sliding block, *N*, and two sets of levers, *A*, may be employed.

It may not be inopportune to mention here that the inclined plane on the Pennsylvania Railroad, at Pittsburgh, is a gigantic engineering structure of its kind, built according to the most advanced scientific designs, and without regard to cost. Teams, freight, and passenger cars are hauled up by means of steel cables, the plane having a total length of 840 feet, with a rise of nearly 43 feet to the hundred. It is built on arches, the longest span being 232 feet, another is 120 feet, and the rest are 60 feet each. The cables for hauling the cars are entirely of steel, and the largest ever made in this country. The engines furnishing the power are of 700 indicated horse-power.

Patents.

The following list of recent patents relating to inter-mural traffic is specially reported for THE STREET RAILWAY GAZETTE by William G. Henderson, Solicitor of American and Foreign Patents, 925 F street, Washington, D. C. A copy of any of them will be furnished by him for 25 cents.

Issue of Sept. 21st, 1886.

349,479 Grip for cable railways, H. Casebolt, San Francisco, Cal.

349,624 Rack rail for railways, R. Abt, Bunzen, Switzerland.

349,344 Safety device for cable roads, L. Goddu, Winchester, Mass.

349,846 Cable car grip, J. J. Endres, New York, N. Y.

349,620 Car starter, O. P. Wivel, Baltimore, Md.

Issue of Sept. 28th, 1886.

350,028 Cable grip, L. B. White, New York, N. Y.

349,738 Car brake, H. S. Park, Henderson, Ky.

350,091 Cable railway car, L. B. White, New York, N. Y.

350,090 Track gripping device for railway cars, L. D. White, New York, N. Y.

349,797 Electric subway, J. M. Jagel, Brooklyn, N. Y.

349,926 Circuit closer for rails, W. Davis, Cranstons, N. Y.

349,846 Railway, E. C. Jones, Kansas City, Mo.

349,868 Conduit for cable railways, L. B. White, New York, N. Y.

349,867 Grip for cable railways, L. B. White, New York, N. Y.

349,913 Part of the permanent way of railways, J. H. & W. Tozer, London, England.

349,689 Slip rail frog for railways, I. Burnett & E. Folliot, Joliet, Ill.

350,079 Traction device for cable railways, J. H. Pendleton, Brooklyn, N. Y.

350,017 Driving mechanism for street cars, N. Rogers, Terre Haute, Ind.

The "Reliable" Sand Box.

Numerous patents have been issued, from time to time, and several expensive contrivances have been tried to provide street cars with sand—and sand boxes are not new to street railway men—but hitherto no satisfactory arrangement seems to have been devised. And if the Car Track Friction Appliance Company's "Reliable" sand box is as useful as it is represented to be, it may become very valuable. Some of the peculiarities of these appliances to street car operations may be gleaned from the accompanying illustrations of the lever and of the sand box. The box is constructed with a hopper, and as the end vibrates, a gate formed thereby can be made to open any desired space (from 1½ inches to 6 inches), and may be operated either by the driver's knee or foot. In these appliances a chute is used, open at the

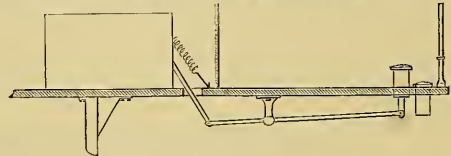

LEVER.

top, to guide the sand, gravel, or salt to the rail, thus obviating, it is claimed, the trouble hitherto experienced with boxes constructed with a pipe. The "Reliable," it is declared, will run wet sand, coarse gravel, or salt, and when the sand or gravel freezes the motion of the gate will break it up. In pointing out the reasons why every street car in the country should be provided with these sand boxes, the

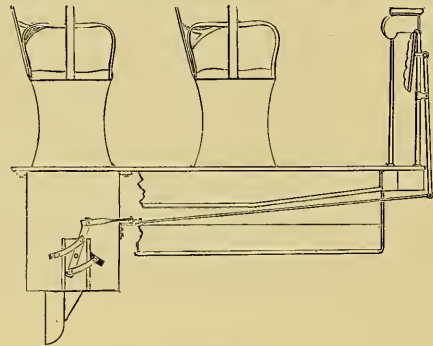

SAND BOX.

inventors and manufacturers declare that they give to the driver complete control over his car, will save much expense and provide a degree of insurance, to companies using them, as a preventive against accidents. Moreover, they can be applied to a car without interfering with any break, or appliance for cleaning snow from the rails, etc.

Railroad Leases.

Unless specially authorized by its charter, or aided by some other legislative action, a railroad company cannot, by lease or other contract, turn over to another company for a long period of time its road and all its appurtenances, the use of its franchises and the exercise of its powers; nor can any other railroad company, without similar authority, make a contract to run and operate such road, property and franchises of the first corporation. Such a contract is not among the ordinary powers of a railroad company, and it is not to be inferred from the usual grant of powers in a railroad charter, according to the decision of the Supreme Court of the United States, in the cases of The Pennsylvania Railroad Company vs. The St. Louis, Alton and Terre Haute Railroad Company, and The St. Louis, Alton and Terre Haute Railroad Company vs. The Indianapolis and St. Louis Railway Company.

Personals.

FRANK H. ANDREWS.

We regret an error in our last number, stating that one of the sweepers illustrated on page 259, Fig. 38, in the article on "Construction, Equipment and Maintenance of American Street Railways," is manufactured by F. H. Clooney; whereas, Frank H. Andrews (successor to Andrews & Clooney) of New York City, is the manufacturer thereof, as well as of the numerous street railway appliances specified on one of our advertising pages.

HOLROYD SMITH.

Mr. Holroyd Smith, the engineer of the Blackpool Electric Railway, hopes, it is said, shortly to pay a visit to this country.

ROBERT LUCE.

Mr. Robert Luce, of the Boston *Globe*, the author of "Electric Railways and the Electric Transmission of Power," has just published a manual called "Writing for the Press," which has won the commendation of some of the leading editors of the country. The Cincinnati *Enquirer* complimented it by reprinting nearly six columns from it in a recent issue.

LAWSON N. FULLER.

Mr. Lawson N. Fuller is about to revive his scheme for seventy miles of cable railway for the city of New York.

Pointers.

ALABAMA.

Birmingham.

This comparatively small city shows much activity, in street railways especially. It has two corporations already, operating 10 1/4 miles of road, with two new companies recently incorporated (as stated in the last GAZETTE) while Mobile, with about ten times as many inhabitants has but three systems of street railways, operating 26 1/2 miles.

The East Lake Land Company will build a street railroad from the city to a new town laid out on its property, a distance of five miles.

The Birmingham & New Pittsburg Street Railroad Company has been incorporated to build a two-and-a-half mile line to the furnaces of the Pioneer Manufacturing Company; capital stock, \$100,000. Incorporators, Enoch Enslay, William A. Walker, Thomas D. Radcliff, Rufus H. Haygood and Thomas S. Smith.

Montgomery.

The Capital City Street Railroad Company will hold a meeting on October 18th to consider the question of increasing the capital stock from \$60,000 to \$75,000. The company is negotiating for rails for three miles of additional track, and two 150 horse-power engines; a two-story brick building, 70x100 feet, is to be erected for the electric plant.

CALIFORNIA.

San Francisco.

Warren Dunham, of Igo, Shasta county, has recently obtained a patent for a grip for cable roads, for which he claims many advantages over those now in use. The grip is a combination of eccentric levers and pulleys. The grip can be held fast on the rope and it is claimed, by reason of the pulleys, can be employed to run at any rate of speed less than that of the cable, as well as with the cable, without stranding the rope. There is a lever to raise the grip entirely, with ease. There is also connected with the device a split-depression pulley, which, by a contrivance attached to the grip, is forced open to let a car pass and closes immediately after. The claim is also made that turn-tables can be dispensed with and that the method of crossing a cable is preferable to any other.

COLORADO.

Central City.

The Gelfini Tramway Company, of Central City, has been incorporated. Capital stock, \$50,000. Andrew N. Rogers, Henry C. Balsinger, B. H. Locke, Robert A. Campbell and Henry J. Hawley, incorporators.

Denver.

A successful experiment has been made to run the street cars by electricity. The wires are laid in a conduit between the rails with a circuit-breaker every twenty-five feet; each car has a copper-bound hickory pole, which slides in the conduit, and is long enough to be always in contact with a circuit-breaker, and so conducts the current to the motor.

CONNECTICUT.

Ansonia.

The papers are grumbling because the often talked of street railroad to Birmingham does not materialize.

Danbury.

The Danbury & Bethel Street Railroad Company has been in trouble. Haines Bros., the contractors, put a gang of men at work in this city, and were shortly after ordered by the city officials to stop work, as it was not being done according to the resolutions adopted. Mr. Frank Works, the company's engineer, ordered the men to resume work, for which he was arrested, and released on bonds.

New Britain.

A stock company is being formed at New Britain for the purpose of building a horse railroad. Capital, \$25,000. Lorin F. Judd is interested.

DISTRICT OF COLUMBIA.

Washington.

A company has been incorporated to run an electric railroad from here to a point five miles northeast of Bladensburg, Md., a distance of eleven miles.

GEORGIA.

Atlanta.

The Metropolitan Street Railroad Company will extend the Washington street line on Ormond and Prior streets to the East Tennessee, Virginia & Georgia R. R. This will open up some desirable property for suburban homes, and will help to build up the city.

Thomasville.

A street railroad is projected.

ILLINOIS.

Chicago.

The Chicago & Hyde Park Railway Company, with the principal business office at Chicago, and a capital stock of \$1,000,000, has recently been incorporated. It is proposed to construct the road, an elevated line, from Chicago with one or more branches, to Hammond, Ind., and from the east line of the town of Hyde Park to a point on the east line of Lake View, with other tracks to points in Cook county yet to be determined.

The Rapid Transit Car Company has been incorporated by James M. Whalang, Chicago; F. A. Woodford, Milwaukee; Jesse W. Starr, Philadelphia; and George F. Archer, Camden, N. J.

The Chicago City Railroad Company has obtained the consent of a sufficient number of property owners and will soon lay double tracks on Indiana avenue, from Eighteenth to Thirtieth streets, and pave it with cedar blocks between curbs.

The Illinois Cable Transit Company has been organized by DeWitt C. Cregier, Louis C. Wachs-smith and H. W. McNeil to lay the McNeil-Rasmussen cable in Illinois. This cable is to be experimented with by the West Division Street Railroad Co., of which Mr. Cregier is superintendent.

About 100 indignant property holders of the Sixth Ward, of Chicago, held a meeting at No. 783 Blue Island avenue, the last week in September, to see what could be done to have the railroad tracks on Twenty-second street removed. The sixty days' time which the company received expired September 25, and nothing had been done towards removing the tracks. Ald. Callerton, Hildreth and Doerner were invited, but "for some unaccountable reason" they didn't turn up. Callerton got the bulk of the abuse, and the language used was expressive. J. J.

O'Kelly said that the mover of the motion for the removal of the tracks (Callerton) went to the people of the west end of the ward and attempted to get their permission to let the tracks at the other end of the ward remain. "It is about time to shut down on any man who wishes to sell the rights of the people," he said. "The tracks are going to be removed whether the Commissioner of Public Works likes it or not."

Owen Coyne thought there was some underlying motive which made the company fight for the tracks. Luke Coyne said that at Callerton's own suggestion the Alderman visited the company. After the visit the company offered \$500 per lot to be allowed to move the tracks nearer the curb-line. Attempts had also been made to bribe him, and he could prove it. A petition with the names of over 200 property holders was placed in the hands of a committee of thirty to be presented to the Mayor.

President Yerkes has been victorious in "the domain of justice," and the permit to the North Chicago Railway Company to commence work on their new cable line was issued October 4, by the Department of Public Works. The company is bound not to excavate more than one-half of any street intersection at any one time, and to maintain a free passageway for teams. All the main pipes, sewer, gas, and other pipes now laid in the streets are to be preserved and protected, and all excavations are to be guarded by day and night in order to protect the life and property of travelers. The company is to have the right to lay side tracks for three blocks during the progress of the work, so that travel will not be interfered with, and the entire work is to be done under the inspection of officers appointed by the Commissioner of Public Works. The company set a small force of men to work at once removing the street car tracks at the corner of Clark street and Fullerton avenue, preparatory to beginning the work of excavating the cable channel.

An elevated railroad for Chicago is being talked of and seems in a fair way to be constructed. J. D. Jennings, of the South Side, and Mr. Huidekoper, of Philadelphia, are among the interested parties.

East St. Louis.

The Continental Cable Way and Grip Company at East St. Louis was organized recently capital stock, \$1,000,000; incorporators, Joshua Brown, H. L. Fox and T. A. Smith.

Jerseyville.

Abraham A. Shobe, of this place, has invented a new cable railway.

Moline.

The Union Street Railroad Company has increased its capital stock from \$21,000 to \$30,000.

Ottawa.

A street railroad company of this place has been incorporated by Frederick A. Sherwood and others; capital stock, \$30,000.

Peoria.

The East Bluff Peoria Horse Railroad Company has been incorporated. Capital stock, \$15,000. Julius S. Storr, L. F. Somers, D. L. Brown and R. R. Pourland, incorporators.

IOWA.

Clinton.

The city council, Clinton, propose to build a new street railway.

Des Moines.

At this city, on October 4, Judge Henderson of the Circuit Court, decided the very important case that had been pending in his court for a week regarding the rival street-car company. The old company (the Des Moines Street R. R. Co.) claimed exclusive rights to all the streets of the city under a charter granted in 1866. The new company (the Des Moines & Sevastopol Street R. R. Co.) received a charter from the present council to lay tracks on several streets not occupied by the old, but was stopped by injunction from the old company. Judge Henderson holds that the old company has not exclusive right to the streets, and if it has exercised it, it was only by toleration of the public. The decision is regarded as knocking \$100,000 off the value of the old, or narrow-gauge company, as the new broad-gauge will commence at once to complete its lines.

KANSAS.

Geuda Springs.

The Geuda Springs Street Railway Company has been incorporated. Capital stock, \$100,000. Joseph M. Young, George W. Hoffman, Chicago, Ill.; L. D. Latham, E. P. Green, H. E. Asp, Winfield; M. M. Towle, Hammond, Ind.; and C. R. Mitchell, Geuda Springs, incorporators.

Hutchinson.

The Hutchinson Street Railway Company has been incorporated. Capital stock, \$50,000. A. L. Forsha, S. W. Campbell, John F. Smith, H. Raif, F. H. Forsha, John Peterborough, Hutchinson, and John Severance, Axwell, incorporators.

Ness City.

The Ness City & Sidney Street Railroad Company has been incorporated by C. B. Lynn and others. Capital stock, \$25,000.

Salina.

The Salina Street Railroad Company has been organized. Directors: M. D. Harrington, of Harrington; Oscar Seltz, M. D. Teague, O. L. Dodge, and E. W. Ober, of Salina. Capital stock, \$50,000.

Scott City.

The Scott City Street Railroad Company has been incorporated, with a capital stock of \$27,000. Directors: Charles Noel, T. J. Smith, N. R. Sawyer, W. R. Gibbs, T. H. Quinstead, and A. J. Ferguson.

Wichita.

The Wichita & Winfield Railway Company, of Wichita, has been incorporated. Capital stock, \$1,000,000. James H. McCabe, Lafayette, Ind.; G. S. Manser, C. J. Forsyth, P. H. Albright, and P. A. Hoffman, Winfield, Kansas, incorporators.

**

LOUISIANA.

New Orleans.

An experimental run to Carrollton and back was made recently with the Ammonia motor of the Standard Fireless Engine Company. The run was very satisfactory. The motor is placed underneath the car, and is the invention of a Canadian, Mr. P. J. McMahon, now a resident of New Orleans.

**

MASSACHUSETTS.

Boston.

The Boston Consolidated Railroad Company has given notice to the public that cars will be run on pleasant Sundays from Charlestown to Franklin Park. The fare from all points north of Causeway street to the park will be 8 cents, and from all points beyond Grove Hall station to Charlestown 8 cents. For all intermediate points the fare remains at 5 cents.

The Metropolitan Railroad Company has been given permission to lay additional tracks on Webster and Orleans streets.

Cambridge.

The stockholders of the Cambridge Street Railroad has passed a vote favoring the early consideration by the directors of the cable or other mechanical system for this line.

Onset Bay.

The Onset Bay Street Railway Company has declared a dividend of 5½ per cent.

Salem.

The Naumkeag Street Railway Company appoints one day in the fall, each year, as a "benefit day" for the employes; all the receipts being divided among the men. Large numbers of people ride on this day in order to make up a good purse.

South Framingham.

At South Framingham, on the 30th of August, an agent of an electric cable railway concern appeared before the board for the purpose of presenting the plan of connecting South Framingham and Framingham Centre, distance two miles, with his railway. On the 7th of September, the court room was crowded at the hearing on the petition of the Suspension Transportation Company for permission to build an electric cable road to carry passengers and parcels between South Framingham and Framingham. Chair-

man Adams, of the board of selectmen, said the selectmen were ready to hear anything for or against the scheme. A. D. Chandler, solicitor of the Electric Suspension and Manufacturing Company, of Philadelphia, said he would answer any questions any one might ask. Rev. L. H. Eastman, Jr., wanted to know whether the patents controlled by the company covered surface cable roads? Mr. Chandler replied that they did not. David Fisk wanted to know how high from the ground the cars would run? Mr. Chandler said they would be run at any height necessary. R. L. Day proposed the appointment of a committee to examine the system where it was in practical operation. E. W. Chandler said the citizens would not be asked to take any risk in the matter. W. C. Wight said that inasmuch as no plans or surveys had been submitted, and as a new petition is to be presented, and that the probability was that a surface railroad company would also present plans and estimates for horse car service, he would move that the meeting be dissolved. This was unanimously carried.

Referring to the above, a South Framingham dispatch of September 17 says: The agitation of the electric cable road scheme, the object of which is to connect this village with Framingham Centre, has been renewed, as the Suspension Transportation Company of Boston, which abandoned the proposed Union avenue route on account of serious interference with the shade trees, has prepared a second survey, the details of which will soon be made public, probably at a hearing called by the selectmen and road commissioners. The new line commences near the westerly end of the Common at South Framingham, running on the easterly side of Franklin street and through the well known Harmony grove to Lake street, and thence over several estates, a portion of the route being on the line of the old Agricultural branch railroad, until Framingham Centre is reached, the terminus there being Central square. The distance between the two villages by the new route is about 1½ miles. The advocacy of a horse railroad line between the two villages is still heard from some of the prominent citizens.

**

MICHIGAN.

Lansing.

The Lansing Transit Railway Company has been incorporated. Capital stock, \$50,000. A. O. Bement, E. F. Cooley, F. Thoman and T. W. Bement, incorporators.

Port Huron.

The Port Huron Electric Railroad Company has been incorporated by W. F. Botsford and others. Capital stock, \$25,000.

**

MISSOURI.

Kansas City.

Work is progressing towards completion on the Inter-State Elevated Railroad from the Union depot, across the river to Wyandotte, Kan. It is claimed to contain many improvements on the New York "L." The engines are being built by the Baldwin Locomotive Company. Sixteen cars, of elegant finish, with the latest improvements, have been delivered from the Pullman works; their capacity is forty passengers, the floors are carpeted, and they will be lighted by electric light.

St. Louis.

The Cable road is carrying a daily average of twenty thousand passengers; large orders for equipment have been placed, to accommodate the increasing business.

**

NEW HAMPSHIRE.

Manchester.

The Manchester Horse Railroad Company has filed a petition for leave to construct a branch on Park street from Elm street to Massabesic street.

**

NEW JERSEY.

The New Jersey Legislature has passed an act enabling street railroad companies to increase their facilities by erecting elevating railroads, providing such elevated roads are operated on the cable system.

Jersey City.

The work of constructing the extension of the Jersey City & Bergen Railroad to Bergen Point is approaching completion.

Orange.

Preparations are being made to build a cross-town electric railway at Orange, N. J., which promises to surpass in many respects anything of the kind in this country, says the *Electrician*. Especial attention will be directed to the track which is to be of a superior character, and will be furnished by the Johnson Steel Street Railway Company, of Johnstown, Pa. The new road will be in a location where it is believed a very large traffic may be developed, passing all the stations of the railroads in Orange, also the hat factories employing 3,000 hands, and the Rosedale Cemetery. The granting of permission to use electricity as a motive power, has been laid over by the City Council, until its merits can be investigated. The attempt of the Schuyler company to obtain a free franchise in Newark, has stirred up a hornet's nest in the City Council, and efforts are being made to inaugurate a new policy by which the city may derive some benefit from its street privileges, instead of giving them away for the sake of encouraging competition.

The Orange Cross Town & Orange Valley Horse Railroad Company has organized, with the following Board of Directors: President, Francis Eppley; Treasurer, Henry W. Lope; Secretary, James E. Brown; Directors, Peter A. Embury, E. A. Pearson, Edwin W. Hine and George Spottiswoode. The work of construction will be done under the supervision of Mr. Eppley, who is a civil engineer.

An electric railroad is to be built here. W. H. W. Pope is interested, and will equip the road.

**

NEW YORK.

Albany.

The street-car conductors and drivers of Albany, N. Y., have each been presented with a \$2.50 gold piece by the company for which they work as a token of their faithful services during the recent bicentennial week.

The Albany Street Railroad Company has decided to adopt the Fairchild's iron cable system for its State street line. The system is in use at Binghamton. It consists of a large and a small cable; the large one revolving a series of drums in the conduit; and the smaller one, which passes over three wheels under the car, is kept in motion by coming in contact with these drums. To stop the car a brake is taken off the three wheels on the car, and the cable expends its energy in causing them to revolve; there is, therefore, no grip.

Bath Beach.

The old shore road in front of the Military Reservation at Fort Hamilton is to be closed, and Church street is to be extended across the parade ground, so as to make a direct road to Bath Beach. It is understood that the Brooklyn City Railroad Company will lay tracks over the new thoroughfare in order to convey Bath Beach residents to the new ferry at the foot of Thirty-ninth street. The residents of the beach do not view the proposed alteration with favor.

Brooklyn.

There is a prospect that the Bergen street cars will not run to South Ferry any longer, most of the passengers going to Hamilton Ferry, and President Richardson does not think the cars pay expenses. The conductors on the three routes of the Bergen street line have been taking statistics of the number of passengers to the three termini on the river front.

The accounts are found to be correct in all particulars, and every voucher filed in a careful and proper manner.

The South Brooklyn Street Railroad Company, of Brooklyn, has been incorporated. Capital stock, \$200,000. Thomas H. McGrath, John Curran, Joseph A. Pool, John H. O'Rourke, L. L. Bergen, Charles V. Van Doren and Francis F. Underhill, incorporators.

The South Brooklyn & Flatbush Railroad Company of Brooklyn, has been incorporated. Capital stock, \$500,000. Thomas H. McGrath, John Curran, L. L. Bergen, Charles H. Van Doren, Francis F. Underhill, John H. O'Rourke, Jeremiah L. Phelan, Stewart McDougall, Henry

G. Clarke, Francis H. Bergen, Heermans B. Hubbell and I. C. Smith, incorporators.

Lockport.

Surveyor Frehsee of Lockport, is preparing the grade for a new street railway.

Melrose.

The Melrose and West Morrisania Railroad Company has been incorporated. Capital stock, \$300,000. Wm. Cauldwell, Matthew B. Wynkoop, 121 Fulton st., New York City, John J. Hallenback, Monclair, N. J., Henry Spratley, Edwin Bedell, Alb. B. Witney and Jas. T. Tompson, incorporators.

Newburg.

The contract for the construction of the Newburg Street Railroad has been awarded to John Graham, New York City.

New York.

Contracts for the construction of over a mile of the Suburban Rapid Transit R.R. have been let, aggregating about \$270,000. Smith and Ripley have the foundations; the cast-iron bases of the columns, The Colwell Iron Co.; and the superstructure, Keystone Bridge Co.

Niagara.

A company was organized some time since for the purpose of constructing a street railway at Niagara Falls. The directors are Messrs. John H. Mooney, A. W. Platt, N. S. Hayward and William H. Kelley, and M. M. Buckley, Thomas Ward and John H. Bache, of Niagara Falls.

President Mooney told a *Herald* reporter:—"The road for the present will be three miles in length. One half of the line has been laid, and cars will be running very shortly. An extension to Drummondville and Chippewa is contemplated. The cars will run from the Michigan Southern Railroad depot through the principal streets of the village to Falls View, near the convent. The fare will be five cents. We think it will be to the interest of the bridge companies to let us run our cars across these structures at the nominal fare of ten cents for each passenger. At present every foot passenger is charged twenty-five cents on the bridges."

Nyack.

A street railway will soon be built between Nyack and Piermont, a distance of three miles along the bank of the Hudson.

Utica.

The Utica Belt Line Street Railroad have made a contract with Hathaway & Robinson, of Cleveland, O., to lay about five miles of track for this road.

Yonkers.

The Yonkers Railroad Company began operations on the 20th of September. This is the first street railroad in Yonkers. It begins at the Hudson River Railroad depot and runs up Main street, Ashford and Yonkers avenues to the depot of the New York City and Northern Railroad, a distance of about two miles and a quarter. The road is double tracked, with thirty-two cars twelve feet long. The chief promoters of the scheme were Messrs. O. Stahlnecker and D. M. Stanton. The capital stock of the company is \$200,000, and bonds have been issued for \$300,000.

The contract for the construction of the Yonkers Surface Railroad has been awarded to James Stewart, of Yonkers.

OHIO.

Cleveland.

Cleveland is to have a much needed horse-car belt line, which will take passengers within one block of the Union depot. The cars will leave Superior street at Bank, down Bank to Lake, Lake to Water, Water to Superior, and thence radiating to the East and West sides. Ever since the rails of the old Bank street line, which ran from the entrance of the depot to Superior street, were taken up, a carriage, or walk of ten minutes has been necessitated before the principal car lines could be reached.

The employes of the various street railroad companies have decided to organize an association to be known as the Street Railroad Employes Benevolent Association, and to include every class of men. The East Cleveland Railway Company made the men a most liberal

offer; it tendered a large room, or hall, rent free, wherein to hold meetings, agreed to chip in one dollar for each dollar paid in for initiation, and twenty-five cents for each 25 cent assessment. The matter is now under consideration, and, as no material obstacles appear to be in the way the offer will, undoubtedly, be accepted.

The East Cleveland Street Railway Company is just building two new box cars that will compare favorably with any in the city. To save the inconvenience incidental to transferring, and for the accommodation of its patrons, the East Cleveland Street Railway has spent \$15,000 in building three-quarters of a mile of side track around a bad fill on Euclid avenue, opposite Wade Park. The fill is being made by the city, and will not be completed much before July 1, 1887.

Delaware.

C. F. Guncle and G. E. Phipps, of Middleton, contemplate constructing a street railway at Delaware

PENNSYLVANIA.

Allgheny.

An electric railroad is to be laid on Federal street, with Pittsburgh as its ultimate terminus. It is projected by the Observatory Hill Street Railroad Company; President, O. P. Scarfe; Secretary, A. Kennedy; Directors, Wm. Thaw, J. B. Scott, J. A. Parke, and C. Caldwell.

Philadelphia.

William Wharton, jr., 330 Walnut street, Philadelphia, has been awarded the contract to build an extension to the Chester Street Passenger Railway.

The North Eastern Railroad Company has been organized to build an elevated railroad on the Delaware river front to Frankford and Jenkintown. The proposition pledges five cent fares during commission hours. George H. Boker, Frederik B. Esler, Charles B. Wright, and others, are interested.

Pittsburgh.

An inclined plane railroad is to be built from Spring Garden avenue, across Troy Hill, to Pine street. Freight and passengers are to be carried, and the motive power is to be electricity. John H. McCreery, R. F. Ramsey, C. A. Cooper, Wm. M. Thorn, and Wm. A. Stone, are interested.

RHODE ISLAND.

Providence.

The Union Railroad Company will have to postpone work till next spring in consequence of delay in the selection of a site for the cable plant.

TENNESSEE.

Clarksville.

A street railroad has been surveyed recently.

Chattanooga.

The Rossville Street Railroad Company has been incorporated here to build a road from this city to Rossville, Ga. Incorporators, J. C. Roberts, S. E. Green and E. B. Warner.

Memphis.

The negotiations for the sale of the two street car lines to a syndicate has fallen through, owing to the refusal of a small stockholder to sell.

TEXAS.

Galveston.

The city council having passed a resolution requiring the mayor to have certain tracks of the Gulf City Street Railroad Company taken up, that company procured injunctions on the mayor, restraining him—as representing the city—from interfering, and at once proceeded to effect the denied connection. The city claims that the company's franchise does not cover the disputed points.

VIRGINIA.

Richmond.

The Richmond & Manchester Street Railroad Company has applied for permission to extend its tracks from Ninth street, along Canal, Clay, Seventh and Lombard, to Main street, with a line to Monroe Park; also, from Main street to

the New Reservoir, with a branch to the Soldier's Home. Work will be commenced as soon as the petition is granted. President, Joseph Bryan.

The Richmond Street Railroad Company has applied for leave to construct lines on Ninth and Leigh streets and Brook avenue; and for the privilege of extending the Main street line to the Western limits.

WISCONSIN.

Ashland.

The Ashland Street Railroad Company has been incorporated by Edwin Ellis, W. R. Durtee, J. H. Knight, and others. Capital stock, \$50,000.

Business Notes.

PULLMAN'S Palace Car Company supplied the new cars with middle doors recently placed on the New York & Brooklyn Bridge Railway.

The new cars and all the elegant equipage for the Mt. Adams & Eden Park Inclined Railway, Cincinnati, with which President Kerper is said to be highly pleased, were supplied by the world-famed Pullman's Palace Car Company.

THE Cable Railway in Cincinnati, of which we give a fully illustrated description in this issue, was constructed under what is known as the Lane system, to push which a company has been incorporated under the name of the Lane National Cable Railway Construction Company, officers of which are as follows: President, S. M. Lemont; Secretary and Treasurer, A. G. Clark; Engineer, H. M. Lane; and the directors consist of George B. Kerper, John Kilgour, S. M. Lemont, A. G. Clark and H. M. Lane.

The Birmingham Street Railway Company, of Birmingham, Ala., has added eight new cars to their equipment, built by the Brownell & Wright Car Company, St. Louis.

THE Brownell & Wright Car Company, St. Louis, is now finishing a number of new cars for the Mt. Gavock & Mt. Vernon Horse Railroad Co., Nashville, Tenn.

THE St. Louis Malleable Iron Works have just turned out 10,000 of the Dickson brace for use on the Cass Avenue line.

The following letter refers to the cable construction of the Mt. Adams and Eden Park Inclined Railway, Cincinnati—

TRENTON, N. J., August 16, 1886.—As near as we can judge, you have the best cable in existence to-day. The life time of cables is a considerable item in the expense, and where they are worn out in a few months, it becomes a question which seriously effects profits. We cannot do better than advise those contemplating the building of cable roads to give your road a careful examination.

Very truly yours,
J. A. ROEBLING'S SONS CO.

THE W. A. & W. Side St. Ry., of Cleveland, Ohio, has adopted the Haycox door fastener, and will have it adjusted to all their cars.

THE Citizens' Railroad Co., Memphis, Tenn., has recently ordered ten cars from the Brownell & Wright Car Company, St. Louis, making forty cars altogether that the company mentioned has built them.

THE Cream City Railroad Co., Milwaukee Wis., is having fourteen elegant cars built by the Brownell & Wright Car Company, St. Louis.

EIGHT new Pullman cars have arrived for service on the Brooklyn bridge. More side door cars will soon be ordered.

REVERSIBLE CAR SEATS—The Gillilan Car Seat Company, of Fort Scott, has been incorporated. Capital stock, \$100,000. J. F. Westervelt, C. N. Gillilan, James G. Ogden, Jacob Rumburg and J. M. Wright, incorporators. This company will manufacture seats for elevated and street cars, as well as steam cars.

HATHAWAY & ROBINSON, Case Building, Cleveland, Ohio, have the contract to lay about five miles of track for the Utica Belt Line Street Railroad Company, of Utica, N. Y.

J. G. BRILL & CO.,
PHILADELPHIA,
Builders of

Railway and Tramway Cars.

GOLD MEDAL
For Best Closed Car
AT
CHICAGO EXHIBITION
OF 1883.



GOLD MEDAL
For Best Open Car
AT
NEW ORLEANS EXHIBITION
OF 1885.

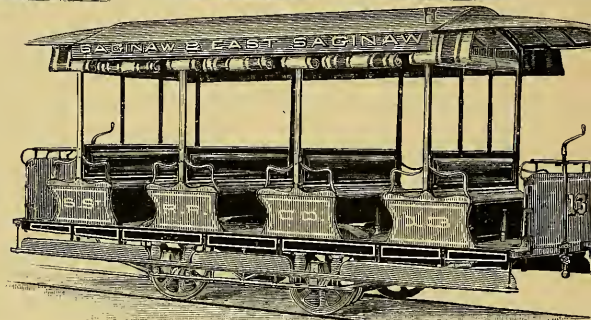
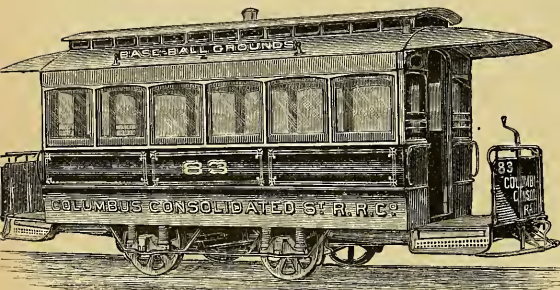
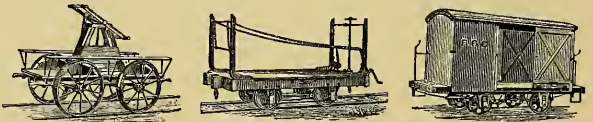

Railway Register Manufacturing Co.

JAMES McCREDIE, *President*, Buffalo, N. Y.

ALARM REGISTERING PUNCH

FOR STEAM AND STREET-RAILWAYS.

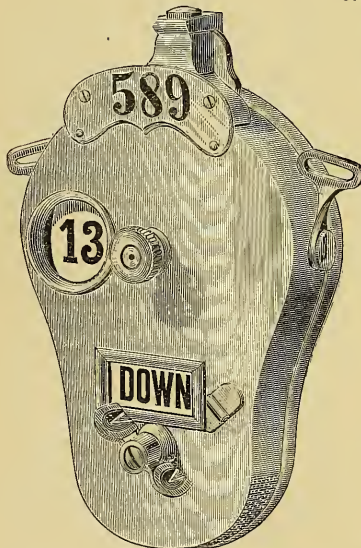

INDICATORS,
ENUMERATORS,
STATIONARY
REGISTERS

And Classifiers
of all kinds for
Registering Fares
on Steam and
Street-Railways.

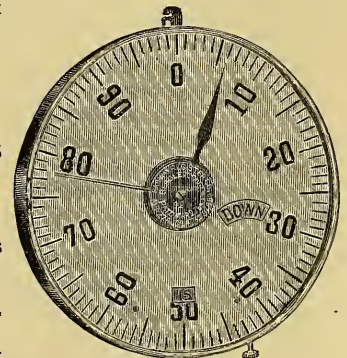

BEADLE & COURTNEY, Gen'l Agents, 1193 BROADWAY, NEW YORK.
Philadelphia Office Removed to 423 WALNUT ST.

The Street Railway Gazette.

VOL. I.

CHICAGO

NOVEMBER, 1886.

NEW YORK

No. 11

Thomas W. Ackley,

PRESIDENT OF THE AMERICAN STREET-RAILWAY ASSOCIATION.

This gentleman was born in Camden, N. J., of American parentage. At an early age he attended the common schools of his native town, and when but fourteen his business career commenced, in a retail dry goods store in Philadelphia, where good habits, integrity, and faithfulness to the interests of his employers secured for him promotion. But in 1843, desiring to change, he entered the wholesale house of Reed Bros. & Co., of the same city, where he remained four years, when he became a junior partner.

In 1853, at the request of friends, he was induced to interest himself, or with others, take part in the management of the Thirteenth and Fifteenth Street Railway Company, of Philadelphia, and was made a director in 1869. The following year he was elected president, and has retained that position to this time.

That Mr. Ackley's management has been profitable to the company is shown by the fact that, when he took charge of its business, the shares were selling at \$13, whereas his tact and energy has enhanced the value of the stock until, at this time, \$152 is freely offered, but none can be had.

Mr. Ackley is president of the Board of Presidents of the Street Railway Roads of Philadelphia, and has large interests in other surface roads in the Quaker City. His company was admitted into membership with the American Street-Railway Association at their third annual meeting, and he was appointed on their Executive Committee last year. He was married in 1849, and has two children, a son and daughter; the son is a member of the law firm of Ackley & Thomson, of New York City.

In conclusion we will say that this gentleman has a pleasant, genial manner that attracts, is in full, robust health, and bids fair to continue for many years the active, useful life which has secured for him the prominent position to which he was elected at the Cincinnati Convention—president of the American Street-Railway Association.

THE variation in load on the Brooklyn Bridge Cable Road, amounts to 200 H. P. in a minute. If this be true, mechanical engineers have a serious difficulty to overcome, for such variations in load mean a short life for the whole plant.

The Reduced Fares in New York.'

Our pointers, in this issue, contain very contradictory statements as to the increase or decrease of the receipts of the New York elevated railways since the increased reduction of fares to five cents. It is probably an enmity that has set afloat the discouraging reports. At all events, outside Gotham itself, the specials say that "the stupendous increase in travel makes it almost impossible to secure seats, and new roads are contemplated." And the following is a fair sample of the "special correspondence" from New York:



NEW YORK, Oct. 11. — People who have not been in New York for some time can hardly realize the immense growth in the upper part of the island and the consequent increase of travel on the elevated roads. Added to this is the reduction of fares on the Third Avenue Elevated. The traffic on the road is now stupendous. Trains after trains of five cars each, only one minute apart, are completely filled here at the City Hall station alone. Passengers a few stations further up must frequently see several trains pass before they can get one with room to take on more passengers. Women are shown very little courtesy, but are shoved aside by the pushing and scrambling men. The latest dodge of the impatient and selfish is to climb through the car windows while passengers are getting off, and so secure the seats which the outgoing passengers have just vacated. The young men and boys, of course, are the ones who engage in this, and they hold on to their seats after they get them, while the women and old men must stand.

On November 1 the Sixth Avenue will, as has been announced, reduce the fare to five cents, and the same scheme may be enacted on that road. Two companies anxious to build an underground railroad in Broadway are fighting each other, while the property holders are fighting both. Now the property holders and the underground roads have another scheme to fight. For the Metropolitan Transit Company, claiming to be organized and sanctioned under some law in 1872, proposes to construct and operate various lines of railroad, both elevated, underground or depressed, and suspended. Exactly what kind of a railroad is intended by a "suspended" railroad does not distinctly appear from the papers in the case.

FIFTH ANNUAL CONVENTION

OF THE

American Street-Railway Association

The Fifth Annual Convention of the American Street-Railway Association was held at Burnet House parlor, Cincinnati, Ohio, on Wednesday, October 20, 1886. Promptly at ten o'clock, President Julius S. Walsh called the Convention to order, and Secretary Richardson called the roll of members, to which 90 of the 137 members responded. After the calling of the roll, the President announced that an opportunity would now be given for other companies to join the organization, and the following companies responded and acquired membership:

E. J. Lawless, Supt. Metropolitan St. Railway Co., Kansas City, Mo.
Harvey T. Weeks, President Chicago City Railway Co.
Geo. S. Clayton, Secretary College City St. Railway Co., Galesburg, Ill.
Walter A. Jones, Vice-Pres. Utica, N. Y., Belt Line St. Railway.
R. E. Turner, President Citizens St. Railway Co., St. Joseph, Mo.
L. P. Young, Supt. Lincoln Street Railway Co., Lincoln, Neb.
E. G. Mosher, Supt. Augusta and Summerville (Ga.) Railway Co.
W. H. Sinclair, Galveston, Tex., Street Railway Co.

The President then read his annual address, which was as follows:

PRESIDENT'S ADDRESS.

Gentlemen.—The annual meeting of the AMERICAN STREET-RAILWAY ASSOCIATION has been convened to-day, the fifth consecutive year, and I beg to express my sincere pleasure in meeting you, and congratulate you upon the large attendance and influential accession to membership. It is an indication that there has been no misconception about the benefits flowing from an organization whose members meet and confer in the spirit of justice, fairness and enterprise, fully recognizing the several relations of the public, the shareholder and the employé.

The business of the past year has been generally prosperous, interrupted occasionally by labor disturbances, and it is to be regretted that many grave problems pertaining to that system still remain unsolved. The scale of wages and hours in the Street Railway service has been regulated by the financial ability of each individual company, and in no other unskilled business has there been paid such a uniformity of high wages. It has come within the observation of all that mechanics frequently abandon a profitable but varying trade to engage in a service where wages are promptly paid, with the occupation steady. Designing men have attempted to estrange the loyalty of our employés, and have succeeded in many cases in arraighing them against the companies. The weakness and inaction of constituted authority has permitted doctrines to be enunciated and disseminated, so monstrous that, if practiced, the perpetrators would be convicted of the grave crime of felony. To remedy the apathy of authority, it behooves us to exercise in every legitimate manner the full vigor of the franchise of American citizenship, and I feel confident that if we called our employés to assist in the work of purification, from the ranks of the thoughtful a generous response would be heard.

With regard to progress in motors as a substitute for animal power, and other pertinent topics, your Committees have consented to submit in writing to the Convention their conclusions, and I feel that if I make any extended remarks upon such subjects I would be trespassing upon their domain.

Gentlemen, I commit the business of the Convention to your hands, and trust that when the hour of adjournment arrives we will be amply repaid, instructed and enriched by the free interchange of thought and experience. [Applause.]

The Treasurer's report was read, by which it was shown there was a balance on hand of \$1,118.07. The report was approved and ordered to be spread on the minutes.

The Convention then proceeded to hear the report of the Executive Committee, who submitted the following, which was adopted and ordered to be placed on file:

EXECUTIVE COMMITTEE'S REPORT.

Cincinnati, O., October 20, 1886.

THE AMERICAN STREET-RAILWAY ASSOCIATION.

Gentlemen.—The Executive Committee respectfully submit the following report:—

APPOINTMENT OF COMMITTEES.

Directly upon the close of the last meeting of the Association, the Executive Committee met and selected the following subjects, upon which papers should be prepared for consideration at the next meeting: "Cause, Prevention and Settlement of Accidents;" "Sanitary Condition of Street Cars;" "Ventilation, Lighting and Care of Cars;" "Progress of Cable Motive Power" and "Progress of Electric Motive Power." Committees were duly appointed, and are, doubtless, ready with their papers. Although there are not as many subjects this year as formerly, the range of topics is broad enough to serve as a very generous basis for the interchange of thought, relative to important branches of our business, and sufficient to make this meeting of great interest to us all.

NEW MEMBERS.

The Association entered St. Louis last year with a membership of 123 companies. At that meeting, and since, 18 companies have joined, as follows:

Dayton Street Railroad Company, Dayton, Ohio.
Newburyport and Amesbury Horse R. R. Co., Newburyport, Mass.
Washington and Georgetown R. R. Co., Washington, D. C.
Kansas City Cable Railway Company, Kansas City, Mo.
Union Depot Railroad Company, St. Louis, Mo.
Cass Avenue and Fair Grounds Railway Co., St. Louis, Mo.
St. Louis Railroad Company, St. Louis, Mo.
Cream City Railroad Company, Milwaukee, Wis.
South Boston Railroad Company, Boston, Mass.
Des Moines Street Railway Company, Des Moines, Iowa.
Knoxville Street Railroad Company, Knoxville, Tenn.
Metropolitan Railroad Company, Washington, D. C.
Duluth Street Railway Company, Duluth, Minn.
People's Railway Company, Baltimore, Md.
Pawtucket Street Railway Company, Pawtucket, R. I.
Milwaukee City Railway Company, Milwaukee, Wis.
Reading City Passenger Railway Company, Reading, Pa.

The total number is now 140 companies, and embraces most of the largest in America, as well as many of the smaller roads.

MEMBERS' NAMES CHANGED.

During the year two companies in the City of Boston, prominent members, have consolidated, forming one company under a new corporate name. The following correspondence in reference thereto explains itself:—

Boston, September 28, 1886.

WILLIAM J. RICHARDSON, Esq., Secretary.

Dear Sir.—I desire to officially inform you that on the 21st of August last, the Middlesex Railroad Company of this city, of which I was the President, was consolidated with the Highland Street Railway Company, under the name of the "Boston Consolidated Street Railway Company," the said new company acquiring all the powers, privileges, rights, franchises, property and estate held, possessed or enjoyed by the old Middlesex and Highland Companies. Will you please therefore strike from the list of members of The American Street-Railway Association the Middlesex Railroad Company and the Highland Street Railway Company, and substitute the name of the new company, the "Boston Consolidated Street Railway Company" in place of the former companies.

Very truly yours,

CHAS. E. POWERS, President.

THE AMERICAN STREET-RAILWAY ASSOCIATION.

Brooklyn, September 29, 1886.

CHARLES E. POWERS, Esq., President Boston Consolidated St. Ry. Co.

Dear Sir.—In reply to yours of the 28th inst., would say, that the names of the "Middlesex Railroad Company" and the "Highland Street Railway Company" have been struck from the roll of members of this Association, and the name of the "Boston Consolidated Street-Railway Company" has been substituted in lieu thereof.

And I remain, very truly yours,

WM. J. RICHARDSON, Secretary.

Three other companies have changed their names during the year, as follows:—(1.) The Easton and South Easton Passenger Railway Company, of Easton, Pa., to the Easton, South Easton and West End Passenger Railway Company. (2.) The Orange and Newark Horse Railroad Company, of Newark, N. J., to the Essex Passenger Railway Company. And (3.) The Street Railroad Company of East Saginaw, Michigan, to the East Saginaw Street Railway Co.

LEGAL OPINIONS.

The following legal papers have been issued during the year, namely:—

November.—Brooklyn Crosstown R. R. Co. *vs.* the City of Brooklyn.
December.—John B. Connor *vs.* the Citizens' Street Railway Company, of Indianapolis.

January.—Timothy Dixon *vs.* the Brooklyn City and Newtown R. February.—Edwin P. Griswold *vs.* the N. Y. & N. E. R. R. Co.
March.—John Scheid *vs.* the 3d Av. R. R. Co., N. Y. City.

April.—John A. Stewart *vs.* the Brooklyn Crosstown Railroad Co.
May.—John Dunn *vs.* the Cass Av. and Fair Grounds Ry. Co.

June.—Mary Laughlin *vs.* the St. Ry. Co. of Grand Rapids, Mich.

July.—Jersey City and Bergen R. R. Co. *vs.* John Costigan and Thomas Egan.

August.—Mary Coddington *vs.* Brooklyn Crosstown R. R. Co.

It will be seen that no opinion has yet been issued for either September or October, none having yet been received thereof by the Secretary. We take occasion to urge upon the members the importance of forwarding promptly opinions in reference to suits against the companies, as the latest law concerning our business is what we are anxious to obtain.

FIRE INSURANCE.

In our last report we dwelt at considerable length upon what had been done relative to the formation of the American Street-Railway Mutual Insurance Company, setting forth the broad basis upon which the projectors of the company had planned to do the business of insuring street railway property substantially at cost.

Inquiries have been made during the year as to whether the company was in a position to take risks. From the lessons gained through losses sustained by some companies during the past year, usually but

trifling, and the vexatious delays and annoyances resulting from the adjustment of the losses, it is to be hoped that the scheme which had been so carefully planned and wisely undertaken will not fail of realization by lack of courage on the part of the companies to embark in the enterprise.

We commend, therefore, mutual street railway insurance as worthy of earnest consideration as a means of reducing a costly department of our business, and at the same time of avoiding intensely annoying delays and difficulties in the adjustment of losses, when losses occur, and which, in case of loss, will inevitably result.

STREET RAILROAD TAXATION.

A very important subject, which closely and deeply concerns the street railroad business, is the taxation by the government in many varied forms of our property and business. Upon the subject of street railroad taxation a very valuable paper has recently been prepared by the Hon. G. Wilson Scribner, President of the Central Park, North and East River Railroad Company, of New York City, and now President of The Street-Railway Association of the State of New York. This paper is accessible to all. Owing to the ingenuity of the government to unjustly tax and increase the burdens of corporations, it behoves us to oppose, by every honorable means within our power, further aggressions, which, though according to law, are thoroughly lawless in conception.

KNIGHTS OF LABOR.

Our business is a perfect financial meter by which to measure the prosperity of the country, there being no industry that is affected more delicately than our own, according as is the business of the country prosperous or depressed.

At about the same period in the spring, all over the country, "strikes" occurred on street railroads, causing in many cases an entire stoppage of the business. This was brought about by an organization called the "Knights of Labor," a secret society, which required absolute obedience to the mandates of the few who controlled it. The injustice of the orders that our employes were required to obey was in many cases admitted by them, but so powerful was the organization at that time that no slavery could have been more abject, and, it would seem, more humiliating than that to which the employes of the street railroads had become the willing subjects. The tyranny of the order was manifestly so un-American that the absolute power which it had shown at the outset soon waned. Exceedingly unwise and even foolish action followed their first efforts: and as a result, what little respect the order had enlisted in the minds of the people was materially lessened by reason of its reckless disregard of public convenience in the wholly unwarranted stoppage of the great business of city passenger transportation. We believe that the public would not tolerate a repetition of its discomforting experiences by the stoppage of our cars; and we are personally assured that only the most foolhardy in the organization would attempt to repeat the strikes of last spring-time. In this connection we can but commend that principle in our relations with our employes which is embodied in the maxim,—"Do unto others as you would that they should do unto you." When a man treats his employes in such a way as he would wish to be treated, were their places changed, his action cannot be far removed from fair, honest and upright dealing. In this, we contend, the managers of street railroad companies will compare favorably with any of the other great business enterprises in the country. The year which had opened so promisingly was, therefore, beclouded, the strikes extending to all branches of business, until, in the aggregate, many millions of dollars were lost to the laboring classes. We believe that the lesson learned by our employes will be lasting; and that they will not soon again attempt to do what could have been so much better obtained, in less time, by direct, personal and manly application to their employers, and without loss to themselves.

REDUCED FARES TO MEETING.

The Central Traffic Association and the main trunk lines from the East having last year generously granted to the delegates of this Association reduced rates to attend the annual meeting at St. Louis, for which due and ample acknowledgment has been made by the Association in the report of the Executive Committee and in the published proceedings of the Association, it was believed the same privilege would be extended to the delegates this year. For some reason the concession this year was refused by the Central Traffic Association. We desire to acknowledge appreciation of the kindness of the Trunk Line Passenger Committee in their desire to secure us the reduced rates; and we trust that the Central Traffic Association will next year extend the courtesies of last year, if for no other reason than that of the natural sympathy which exists between our businesses.

INVITATIONS TO MEETING.

Invitations to this meeting have been sent to all the street railway companies in the United States and Canada; and we believe that the attendance will be sufficiently large to make this meeting one of unusual interest.

OBITUARY.

In closing we are called upon to record the death of the President of one of our members—Mr. John B. Slawson, at the time of his death President of the Central Crostown Railroad Company, of New York City. Mr. Slawson was for many years prominently known as a leading street railroad inventor and business manager. It is with deep regret that we are called upon to make this record of the loss of an esteemed friend. Respectfully submitted,

JULIUS S. WALSH,
C. S. RICHARDS,
THOMAS W. ACKLEY,
WILLIAM J. RICHARDSON.

C. B. HOLMES,
JOHN KILGOUR,
C. C. WOODWORTH,

Letters of regret were read from absent members deploring their inability to attend.

The reading of the paper entitled "Cause, Prevention and Settlement of Accidents," by ex-President Calvin A. Richards, occasioned a lively and lengthy discussion among the delegates. His masterful review of the subject received the unanimous endorsement of the Convention. He claimed that the percentage of accidents had increased since the introduction of open cars, and that the most claims come from those who allege "they were getting on or off, and the conductor rang the bell before I got on or off." He argued that most accidents occurred through the fault of the injured party or the employes, and that conductors should be taught that time is of no consequence when accidents to their passengers are liable to occur, and that safety lies in taking time to make a trip. He charged that professional damage-seekers, dead-beats, lawyers and doctors were in league to defraud the car companies, and that this sort of dishonesty should be exposed, so that the public may know of these gigantic schemes to systematically rob the street car companies. He advocated arbitration as the best method of adjudicating damages between the company and the party injured, and to pay reasonable damages, but in no case encourage bulldozing and fraud.

Mr. Lawless, of Kansas City, related the methods of his company in treating such cases; and Messrs. Richardson, Merritt, Cleminshaw and others added to the general discussion.

Following is a summarized report of an article entitled "Progress of Cable Motive Power," by Mr. E. J. Lawless, of Kansas City, which was read at the convention:

Mr. President and Gentlemen: Your committee respectfully offer the following report: Not many cable lines have been added to the list since our last meeting; but considerable preparatory work for the construction of them, as well as additions to those already built, have been completed; and many franchises have been granted for cable roads in different cities throughout the States.

In San Francisco, two miles of double track have been added to the Market street system. This branch line, with power house and fully equipped for operation, cost about \$400,000.

In Los Angeles, two cable roads have been built; They are single track, each $1\frac{1}{2}$ miles long, with three intermediate and two terminal turn-outs, upon which four trains are usually operated. Each road cost about \$100,000.

The St. Louis cable road was completed and put in operation last spring.

In Cincinnati, four miles of double track, in addition to those already operated, are in course of construction.* No material changes were made, except some improvements to amplify construction in curves.

In Chicago the City Railways are adding several miles of cable to their present system, which works very satisfactorily, the cables running very steadily for weeks at a time, without a break or interruption, although taxed severely with ever-increasing business.

New York and Philadelphia also contemplate extensions to their present systems.

In Omaha several miles of cable road are in course of construction, the plans adopted in Kansas City having been very generally followed.

In Melbourne several miles of cable road have been laid and more are in course of construction. They are built on the same principle as those in San Francisco; a sample grip and grip-car having been sent from that city. The system has proved very successful there.

In Kansas City, however, more work has been done toward the extension of this system than anywhere else.

In this line two companies now running horse-cars are contemplating changing to the cable system, and the cable company is extending its system. Last July they built one mile of double track extension to their present line, constructed on the existing plan and are now building two more branches, one of which is nearly completed. One of these branches differs slightly from the main line, being a copy of the Market street line in San Francisco, except that the yokes are of cast iron; and concrete piers are dispensed with. The yokes weigh 375 pounds each, laid four feet apart on concrete foundation. The conduit is also of concrete. Track rail is bolted directly to the yoke without stringers or chairs. Stone paving is placed between the slot and track rail. The carrying sheaves are twelve inches in diameter, placed thirty feet apart. Another branch two miles long is being built. The following is extract of test of engine and boilers made in July:

Engine cylinder, 24x48; nut coal burned. Duration of trial, 17 hours. Coal burned, 1,400 lbs. Coal per H.P. per hour, 5.1. Water evaporated, 7.37. H.P. engine, 159.7. Power for cable engine and machine, 119.06. Power for cars and passengers, 40.64. Yokes of cast iron 385 lbs. each, laid 4 feet apart on concrete foundation. Slot rail is of angle steel, with a friction service of $1\frac{1}{2}$ inches for grip shank weighing 38 lbs. per yard, bolted to yoke with counter-sunk bolts, pieces of sheet iron being placed between slot rail and yoke for adjustment. Center bearing track rail resting on steel chairs bolted to the yokes. Conduit is formed by concrete connections from conduit to main sewer, made when necessary for drainage.

Three branches of the Metropolitan, of Kansas City, will convert their horse into cable traction in the near future, on which the yokes will be of cast iron with a 4 foot 2 inch base, 340 pounds weight, laid 4 feet apart on a concrete foundation, the slot rail being of Z shape

*As stated in the October issue of THE STREET RAILWAY GAZETTE, the Mt. Adams and Eden Park Inclined Railway (referred to by Mr. Lawless) was opened a few days before the Convention met.

fastened to yoke by bolts and $\frac{1}{4}$ -inch bolt rods, the top of the slot rail slightly inclined from the outer edge to prevent horse shoes and buggy rails from entering it. Conduit of concrete 6 inches thick, where background is solid 12 inches thick, elsewhere of Portland cement; cast iron chilled carrying sheaves 12 inches in diameter laid 30 feet (?) apart, at hill summit diameter of carrying sheaves is increased to 3 feet, to provide for angle and cable strain, and there special sewers are made draining the pits containing the large sheaves, as also at the front of all inclines. These pits being connected with the city sewer by 12-inch pipes. An idea of the work done and material used on this line may be gained from the following table:

| | |
|---|-------|
| No. of yards of earth excavated per mile of single track..... | 4,055 |
| Yards of concrete..... | 3,000 |
| Yards of paving stone..... | 3,130 |
| Yards of sand..... | 2,050 |
| Yards of gravel..... | 175 |
| Number of tons of yokes..... | 225 |
| Number of tons of track rail..... | 98 |
| Number of tons of slot rail..... | 98 |

No. of brace rods for slot rail $\frac{3}{4}$ in. \times 2 ft. 5 in., 2,640 = 10,890 lbs.
No. of slot rail bolts for fastening slot rails to yokes $2\frac{1}{2}$ in. \times $\frac{5}{8}$, 5,280 = 2,508 lbs.

No. of bolts for fastening slot rail splices $1\frac{1}{2}$ in. \times $\frac{3}{4}$ in., 704 = 264 lbs.
No. of bolts for fastening track rail to bolts $2\frac{1}{2}$ in. \times $\frac{5}{8}$, 7,920 = 6,336 lbs.
Carrying sheaves and frames, 4 tons.
Curve pulleys and frames, each, 175 lbs.
Estimated cost per mile single track, \$50,000.
Driving stations will contain 2 Corliss Engines, with heater, pipe fittings, etc., estimated at \$25,000.
Machinery, \$18,000; boilers, \$13,000; building, \$15,000.

Last winter it was found that one trip of the cable with plow sufficed to clear the track of all snow, sufficient slack being allowed for contraction of the cable at a temperature below zero. Your committee is of opinion that experience has demonstrated the fact that the building of cable roads has increased the value of adjacent property fully 100 per cent.

Motion made and adopted that the above report be placed on record.

Mr. Holmes, of the Chicago City Railway Co. (cable), was called upon for remarks in connection with the foregoing article, and stated that they have no trouble with their cable road now; that they make an average speed of 10 miles an hour through the densest part of the city, and 10 $\frac{1}{2}$ miles through the southern half of the city, and that they couldn't think of carrying the millions who patronize the road with the aid of horses only; that the people of Chicago feel they can rely upon the cable system.

Mr. Cregier, of Chicago, was introduced. He concurred in Mr. Holmes' opinion of the cable system.

The afternoon session opened at 8 o'clock. The Convention after being called to order, proceeded to hear the report of the Committee on "Ventilation, Lighting and Care of Cars" by Walter A. Jones, of Brooklyn, N. Y., vice-president of the Flatbush and Williamsburg Railroad Company. The ventilation of cars, the paper stated, was a subject worthy of careful consideration. There is a growing demand on the part of the public for heated cars during the winter season, and as a consequence the evils of impure air must be provided against. The only method of ventilation hitherto employed was to have the ends of the cars open and side ventilation when the weather made it permissible. Until electricity is made applicable to street cars the lighting of street cars can only be rendered effectual by moving lamps at either end or in the middle. In the care of cars, renovation at stated times with paint and varnish was recommended, and with proper care would last 14 years. It is difficult to regulate heat in a street car, it is liable to run up to 75 or 80°. Pure air on a cold day is far more preferable than the foul odors which arise from the impure air in heated street cars in districts where contagious diseases exist.

Mr. Woodward stated that the constant opening and shutting of the doors kept the temperature down.

Mr. Sage: "We put stoves on our line and our patronage increased 25 per cent. More poor people ride on cars in winter than there are rich."

Mr. Richardson: Our road was the first to introduce stoves on street cars in Brooklyn and we have had a marked increase in the number of passengers carried. We have had a number of devices for heating cars but our experience is that stoves are the best for that purpose; it takes up but one seat in a car—it makes one more passenger stand, while it costs but 10 cts., a day. It is an absolute fact that the ladies will come out in large numbers on a cold day when our cars are heated. It is a race between us and a parallel line as to which will get stoves in the cars first in the winter. If we take our stoves out there would be a marked falling off in the receipts of the company; that probably is the best evidence.

Harper, Peoria: Our receipts increased four hundred and fifty dollars over the preceding year after putting stoves in our cars.

Littell, Kentucky: Has the death rate increased any in your city?
Harper: None that I know of.

Merrill: Not only is this question a local one but it is still more localized (if I may use the term) in the localities where it is to be used. In densely populated districts the heating of cars is impracticable. In suburbs where the population is sparse it would be practicable.

Mr. Kilgour asked if there was any legislation, municipal or otherwise, in any States on this subject. Mr. Williamson stated the question was brought up in the Kentucky legislature, but no action was taken

in the matter. If it was compulsory in all cities to supply them with heated cars it would operate very badly on some.

Letters were read inviting the delegates to visit the Chamber of Commerce, the Moerlein Brewing Co., and the "Zoo" which were received with the thanks of the Association.

A committee of seven members was appointed to report on list of officers for the ensuing year and also to fix place for holding the next meeting.

An informal discussion was then had on the different methods employed in engaging conductors for street cars.

Mr. Richardson thought the method of holding money back or requiring a fixed amount to be deposited before engaging a conductor, as one that did not do any good.

Mr. Holmes stated that when his company engages a conductor, the latter pays \$25 and a driver \$50 for the privilege of employment, and it remains optional with the company when a conductor or driver quits their employ, whether the company pays this sum back to them or not. This method has had a salutary effect upon both. The driver can do more damage than the conductor; the latter can ring his bell too quick, for this or any other fault it is agreed that he forfeits his deposit.

Mr. Littell, of Kentucky, stated that they hold amount deposited in case of any damage done the company. Employés who remain longer than one year are paid 10 per cent over first year.

Mr. Rugg, of Boston, thought there was no necessity for deposits; companies doing so should pay interest thereon.
Adjournment had until 10 A.M. Thursday.

THURSDAY, Oct. 21, 1886.

Convention opened at 10 A.M. A letter was read from Mr. T. C. Robbins regretting his inability to attend. A paper entitled "Progress of Electricity as a Motive Power," by Mr. Robbins, as chairman of committee was read, of which the following is a summary: The report began by detailing the difficulty experienced in the field of electric locomotion due in a great measure to the great number of visionary experimenters which it attracts.

The experiments of Prof. Page in 1860, who was enabled to drive a car load of passengers through the streets of Washington with an electric locomotive traveling twenty miles an hour was cited.

Nothing however of sufficient importance was achieved until 1879, when Messrs. Siemens and Halske, of Berlin, operated a small electric railroad of about one-third of a mile in length. Passing over a number of minor experiments which followed the achievement of Siemens, the first notable example after that of Prof. Page in this country, was the motor of Thomas A. Edison in 1882, which is said to have attained a speed of nearly 40 miles an hour on a level track. Later in the year 1882, Leo Daft constructed a number of small electric locomotives, which were the first recorded example of locomotives running on the same track, at the same time, from the same generating apparatus.

In the fall of 1882 an experiment was made at Chicago with a motor consisting of a Weston machine placed upon a platform car, and driven by a second Weston machine by means of two copper conductors placed near the track.

In February, 1883, a motor constructed by C. J. Van Depoele operated a car which is stated to have been capable of carrying twenty-five people.

In May, 1883, an electric motor towed a car weighing over ten tons, loaded with 68 passengers, over the Saratoga and Mt. McGregor railroad, including a gradient of 93 feet per mile. Though several difficulties were here experienced, sufficient was accomplished to prove the possibility of commercial electric traction.

In August, 1885, Messrs Knight & Beutley of Cleveland, O., operated a small road in that city with subterranean conductor, which may be said to be the first serious attempt at that form of conduit in this country.

In 1885 C. J. Van Depoele constructed and operated a locomotive which is said to have done excellent work.

The Baltimore and Hampden Electric Railway is the only commercial plant which has been operated for a sufficient period to allow of a proper statistical comparison, not only with horses, but other mechanical tractors. This road is operated by the Daft system, and in refutation of the charges made that electricity is unsafe, the experience of a year's constant running, 18 hours per diem, has demonstrated that so far as life is concerned it is absolutely harmless. Regarding its uncertainty, again quoting experience, the committee state that it is as certain as any other form of mechanical tractor in all welters.

For the year ending September 11th, 1885, the road carried with three cars propelled with horses 227,155 passengers at 5c each, making \$11,357.75. For the year ending September 1, 1886, the road carried with two cars propelled by the Daft Electric Motor 311,141 passengers at 5c each, making \$15,557.05, an increase of 83,986 passengers with two cars propelled by electricity against three cars propelled by horse power for the same corresponding time, and an increase of money of \$4,199.30.

The average cost of horse power per day is estimated at \$6.50. The average cost of electric power per day on this road is:

| | |
|------------------------------------|--------|
| 13 Tons of Coal at \$3.50..... | \$5.25 |
| Engineer..... | 2.00 |
| Fireman..... | 1.50 |
| Oil and Waste..... | .50 |
| Interest on Plant and Repairs..... | 2.75 |

Making a total of \$12 per day. The power furnished at this cost is ample to run three motors and cars on this road, making electric power per car per day \$4. Under favorable conditions, such as

cheaper fuel or water power to drive the dynamos, and more favorable gradients and curves, cost would be proportionately reduced.

(Signed) T. C. RICHARDS, *Chairman*.

At the close of the reading of the report, a discussion took place among the delegates.

Mr. C. A. Richards compared man's knowledge of that majestic power called electricity, to that of an infant child who was born and being led, and as one man dropped the feeble hand, another took it up.

Mr. Holmes wished the delegates to extend a cordial greeting to every man who is striving to harness the mysterious force of electricity and make it applicable to the necessities of man. His company has expended \$6,000,000 on its present cable system, but when a better system appears, he would adopt it.

Mr. Moxham referred to electricity as "a tough old maid." In its application to street railway propulsion, the electric scheme had not prospered as it should. He thought very little advance had been made, and doubted the practicability of its success in a city.

Mr. Wharton was surprised at the results attained by the electric railroad in Baltimore. He had examined the system, and while he thought it would prove of infinite value to suburban roads, in its present crude state it was not applicable to cities. This system is of the three rail kind. Ice and snow had no effect upon the friction between wheels and rails, and he gave an interesting description of the ease with which it surmounts the steep grades.

Several other members gave their views on the matter, and the general opinion expressed was, that there was a lack of practical fruit about the performance of electric motors, and that, as a substitute for the present motive power, it would require more investigation before its adoption could be recommended. Mr. Wharton, with a view of testing its practicability, stated that he has applied for a franchise to operate a gravity road in Fairmount Park, which will be propelled by electricity. Electricity, he said, is now an infant, but it's destined to grow to a Hercules. He opined that the method of using storage batteries would be ultimately successful.

The paper of Mr. E. C. Lusher, of Montreal, entitled "Sanitary Condition of Street Cars," was read by the Secretary. In the writer's opinion, every one, from the superintendent down to the driver, should be vaccinated. Although no danger from epidemics is feared from the car itself, the cars should be washed and sprinkled with chloride of lime as often as possible. The public should be assured that the cars are absolutely clean; but as the average passenger fears the odor of chloride of lime as much as he would a death's-head and cross-bones, they should be kept in ignorance of how the work is done. After citing the liability of contagious diseases being propagated in street cars, the report suggested the removal of all woolen cushions and the substitution of leather-covered ones instead; and also the substitution of wooden matting for carpets as a preventive of the spread of contagious diseases.

The report, on motion, was accepted, and ordered to be placed on file, after an informal discussion was had, and Mr. Wharton and Mr. Moxham briefly sketched the various sorts of roadways in use.

The Committee on Nominations reported the following selections of officers for the ensuing year:

President, Thomas W. Ackley, Philadelphia.
1st Vice-President, Albert G. Clark, Cincinnati.
2d Vice-President, William H. Sinclair, Galveston, Texas.
3d Vice-President, Prentice W. Cummings, Cambridge, Mass.
Secretary and Treasurer, W. J. Richardson, Brooklyn.

Executive Committee, Julius Walsh, St. Louis; Henry Hurd, Washington, D. C.; C. D. Wyman, New York; Dr. E. Everitt, Cleveland; S. S. Spaulding, Buffalo.

Philadelphia was selected for the place of holding the next meeting on the third Wednesday in October, 1887. Messrs. Schoolcraft, Kerper, and Watson were selected as a committee to escort the newly-elected President to his official chair. He was received with applause and made a brief address, thanking the Association for the honors conferred upon him, and stated that he would perform the duties of his position to the best of his ability. The thanks of the Convention were tendered the retiring officers, and the Convention adjourned *sine die*. At 2:30 the delegates, on invitation from Mr. G. B. Kerper, made a tour of inspection of the cable line.

THE BANQUET.

The famous Gibson House never furnished a more elaborate affair than on Thursday Oct. 21st. The fame which heretofore has attached to this house did not suffer on this occasion. When the guests marched into the spacious and elegant dining hall, they were agreeably surprised at the beautiful display. Flowers in profusion everywhere, music from a select orchestra, and the long tables were elegant in their furnishing and adornment.

There was a pleasant change from the engrossing deliberations of the Convention, when one hundred and fifty of the members of the Association and a few prominent guests sat down to one of the most elaborate banquets known in the history of the Gibson House. The management is deserving of praise in the highest terms for the manner in which the details were carried out. Promptly at half-past eight o'clock, the procession, headed by Mr. A. R. Clark and the invited guests, took up the line of march from the parlors to the large dining rooms. The tables extended on either side of the room, crossed at the west end by another, at which sat Toast-Master Clark, officials of the Association and the distinguished speakers of the evening. Among these latter were Hon. Moody Merrill, of Boston;

Prentiss Cummings, of Cambridge; Thomas W. Ackley, of Philadelphia; Calvin A. Richards, of Boston; Hon. M. Ryan and Lewis Seabrook, of Cincinnati; M. Halstead, of the *Commercial Gazette*; Allen O. Meyers, of the *Engineer*, and Col. G. G. Miner, of *The Street Railway Gazette*.

THE BANQUET BOARD

Was profusely but artistically decorated with flowers and evergreens, some of the designs being very ornate. Hidden behind an immense mass of tastefully-arranged evergreens, and immediately in the rear of the presiding officer of the occasion, was Currier's Orchestra, which, during the serving of the courses, rendered operatic and popular airs. The guests exercised their own discretion in selecting companions for the feast, and in consequence a general feeling of acquaintanceship prevailed, everybody seemed at ease and social intercourse waited upon the appetite, or accompanied the dispatch of the good and substantial things offered by the local committee.

The menu cards were marvels of the printer's art. On the back was the picture of a street-car laden with hilarious mules, and underneath the motto, "Let Us Rest From Our Labors and Be Gay." At the top, in colored letters, was the inscription: "Fifth Annual Dinner to the American Street-Railway Association," and beneath, "Given at the Gibson House Oct. 21, '86." An ingenious arrangement of spikes made out the year "1886." Within was a humorous cartoon of a street-car dashing along at full speed, and an old lady wildly waving her umbrella. Then followed

THE MENU.

Blue Points on shell.
Haut Sauternes.
Primitane Royale.
Filet of Sole.
Sauce Beurre.
Celery en Mayonnaise.
Supreme of Chicken.
Chateau Lafite.
French Asparagus.
Terrapin.
Southside.
Champagne Punch an Burgundy.
Cigarettes.
Filet of Pheasant.
Pommero Sec.
Lettuce.
Ice Cream en Forme.
Cake.
Black Hamburg Grapes
Roquefort and Brie Cheese,
Coffee, Cigars.
Liqueurs.

LOCAL NOTABLES PRESENT.

The officers and members of the Association in the city were out to a man. Among those of the city notables who graced the occasion with their presence, besides those mentioned above who occupied the seats of honor, were noticed Mr. J. E. Bell, Thomas Zimmerman of the Burnet House, Captain G. N. Stone of the Telephone Company, E. V. Cherry of the Board of Aldermen, City Clerk Ed. Henderson, and J. M. Doherty, President of the Mount Auburn road.

THE SPEECH-MAKING.

It was ten o'clock before Toastmaster Clark announced the first event on the programme of speech-making. He had endeavored in vain to avoid the duty of presiding. Unfortunately a draft had struck his voice and somewhat impaired its silvery ring. On behalf of the people of Cincinnati he expressed the hope that their guests had enjoyed their visit, and if they went away saying so it would be the greatest compliment that could be paid to Cincinnati. The first toast is, "Our Guests." It is our sincere hope that their remembrance of Cincinnati will be measured by the same degree of pleasure which it affords us to greet them. He called upon

MR. MOODY MERRILL, OF BOSTON,

To respond. Mr. Merrill was very warmly greeted, and said that no one present felt more delighted than he to be the guest of the railroad management of Cincinnati. He asked indulgence for what was his first effort at after-dinner speaking. In Boston they had an organization called the Presidents' Association, and one of its principles was that the presiding officer (Mr. Richards) should do all the talking and the others all the listening. It was the greatest honor of his life to have been President of the Association which has just concluded its labors. The older members knew with what care and anxiety he had watched its course. It made him feel proud to look upon this assembly of intelligence—this gathering of railroad managers. He pleasantly alluded to the kind feelings engendered by these banquets, and suggested that the Executive Committee should take some action to insure their perpetuation. Philadelphia, he knew, was quailing when she thought of what was before her. To the people of Cincinnati he would express the visitors' high appreciation of the generous hospitality accorded them. There was, however, a more serious subject to be dwelt upon. It was probably the last time he should address them as an important railroad official. [Cries of "No."] He had passed through in his career what few had experienced. He then detailed his entering into the street railroad business in Boston fourteen years ago on what was known as the Highland route. After dwelling upon the dividends paid by the roads in Boston, the inauguration of

the system of consolidation and the advantages that had accrued, notwithstanding that great doubt had at first been expressed as to the result. Street railroads, he said, were run solely for the purpose of making money, and consolidation had increased the revenues of the companies and redounded to the advantage of the public. He closed with the heartfelt wish that the day would not be long coming when the visitors from Boston could return the generous hospitality of the good people of Cincinnati.

"OUR RETIRING PRESIDENT."

Mr. Clark then announced the second toast—"Our Retiring President—whose gentlemanly and intelligent administration has increased the respect which we already felt for him as a fellow-member."

Three cheers and a tiger were given for Mr. Julius S. Walsh, of St. Louis, who referred to the fact that last year he had assumed the duties of presiding officer with trepidation, and expressed the wish that the same kindness and consideration extended during his incumbency would always continue. To all the members he returned his sincere thanks. Their deliberations at the present Convention had been momentous, of the deepest interest and effect on the future prosperity of the companies belonging to the Association. They had been of such a character as to be instructive, and to afford the greatest amount of benefit. As to this social entertainment, it was nothing more than he had expected from Cincinnati. He must say that it came up to the full measure of his expectation.

"OUR PRESIDENT."

"Our next toast," said Mr. Clark, "is to our President. May he bear the cares of office lightly, and upon his retirement have the satisfaction of knowing the good work has gone bravely on."

Three cheers and a tiger also greeted Mr. Thomas M. Ackley, of Philadelphia, as he arose to respond to the sentiment. He had attended the convention for a double purpose.

First, he had come to receive information, and then he was delegated to invite the next annual Convention to meet in Philadelphia. He brought with him the warm invitation of every street railroad in Philadelphia, and cordially wished all to join them in that city in October, 1887, and he would guarantee to each and every one the heartiest of welcomes.

"PUBLIC OPINION."

For the next sentiment, said Mr. Clark, he had found few anxious to respond, but the selection had fallen on Mr. C. B. Holmes, Superintendent of the cable roads of Chicago. His subject would be "Street Railroads and Public Opinion." Mr. Holmes said that in turning the subject over he was reminded of the time when the ice broke with him, and he found the water very cold and very deep. The subject intrusted to him he had found to be fathomless, and before taking the fatal plunge he wished to express his deep gratitude and sense of obligation for the efforts of the people of Cincinnati to make their stay delightful. Passing along the streets, he had noticed the lofty architecture, the numerous educational institutions, the Public Libraries, and when he learned what Cincinnati had done for music, science, and the arts he had concluded it was a good thing to be a Cincinnati. He referred to the Roman patriot at the plow. The name of Cincinnati had come down through centuries, but years had only added glory and brightness to the name, because his thoughts were not of himself, but to his country and posterity. This city was well worthy to be called after that grand old Roman statesman, for her acts had been for the good of her children and coming generations. If he remembered rightly it was seventy years ago when the first steamboat that ever plowed the Ohio was launched at Cincinnati, and not long after the pack-horse gave way to the steam-horse. Since then other scenes had been enacted here scarcely less notable. He pleasantly alluded to Mr. Kerper and the cable road, applying the anecdote of the child that had found a new beetle, and was told to put it down, as it was a plant that would revolutionize the world. Sometimes the public looked on their schemes with an inverted view. Managers should always pay attention to enlightened public opinions. The effect of these meetings on public opinion was like the irresistible force of an immense hammer.

The orchestra played several national airs, "Dixie" and "Yankee Doodle" being greeted with rounds of applause.

"OUR HOMES."

Mr. Calvin Richards, of Boston, then eloquently and touchingly spoke to the sentiment, "Our Home and the Ones We Left Behind Us." He urged all to bring, next time, their wives and children. He had found here the whitest souls and the finest men he had ever seen.

General M. Ryan, in a characteristic speech, spoke to "Our Passengers," ingeniously taking the vein that Mr. Kerper had transformed our woodlands into a great city, replaced the cow-bell with the gong of the cable car, so that where land formerly sold per farm, it was now sold per front foot. He neatly coupled Mr. Kilgour's name with that of Mr. Kerper.

MR. HALSTEAD ON THE PRESS.

For the toast, "The Press," Mr. Clark presented a gentleman who needs no introduction, Mr. Halstead. That gentleman dwelt in interesting terms on the importance of the street railroad interest, the good it had done for the city, and how, with the press, it was engaged in building up Cincinnati and placing it in the rank of leading American cities.

Col. G. G. Minor of the STREET RAILWAY GAZETTE, responded to "The Outside Press," as follows:

The notice to respond to this sentiment, gave no sign as to what was meant by the "Outside Press;" there are many and various journals, and while we know that the press generally contrive to be on the inside when news are to be had, we have yet to see the first specimen of the "Outside Press." If the gentlemen who prepared this programme, intended the press outside the City of Cincinnati, then we feel at liberty to say a few words, that we hope will be received without criticism.

"The Outside Press" embraces a great variety of publications that forage for matter in various fields. Did they intend that we talk about the technical press? The "No seat no fare press"? The Outside Daily Thunder, The One Cent Daily Tickler, or the modest monthly that seeks to aggregate the experience and practice of gentlemen like these assembled here, who are doing their level best to give the denizens of crowded, pent-up, busy cities, oxygen, space and cleanliness, and, better, freedom for a part of the day from the ravages of sewer gas.

Speaking for that modest and nowise numerous class, it can be said that while they restrict themselves to the task of reporting your triumphs, your failures, your improvements, your discoveries and your needs, and sometimes your dividends; they bespeak your patience, and ask that you consider the difficulties that beset them. Now conventions are a prolific theme to help fill the columns of a journal, but you manage to have but one a year. Then, again, the motors for street railroads are soon counted, mules, horses, cables, electricity, caustic soda, with an occasional spasmodic attempt to switch off to ammonia, compressed air or some chemical compound that promises well to the projector, but when the horse sense of such men as are gathered here is applied, the inventor has nothing but kind words and good wishes to pay him for his trouble.

The modest journals that essay to serve the men who do so much to enhance the value of suburban property, who ruin the business of medical gentlemen and pharmacists, who are, or have been, the horse breeders' best customers, who have learned to their sorrow or cost what is the price of an average municipal legislator—the men who have so much business in courts of record as defendants—have an idea that you are certainly entitled to some consideration at the hands of journalism. They are making it possible for the gregarious animal to follow the instinct which nature has implanted in him; they make it possible for millions of humans to daily gather upon a few acres, trade chaffer and cheat one another till they are tired, and then, as night comes on, swiftly hurry them to homes where comfort and family cares await them. Gentlemen, you need journals that shall correctly inform an intelligent public of your grand work, journals that shall bring the "no seat, no fare" mosquito to his senses, journals that shall show that your roads cost every cent enumerated in your capital stock, journals that shall hold up to scorn the envious galoot who rides on your cars, and, forsooth, because he has paid four cents for a five mile ride, takes the liberty to tell innocent passengers that they are paying fare to enable dividends to be declared on water; while your polite, faithful conductor is powerless to abate this vile, peripatetic slandering nuisance, who will not, or can not see that water is a *sine qua non*.

You require journals, with skillful artists to publish from time to time elegant portraits of those among you, who were born very early in life, of poor but honest parents, who commenced as sweepers in car barns, and by honesty, sobriety, and an eye for the main chance, have achieved fame, fortune, and the confidence of the stockholders.

The moral effect of these portraits, and the well written plausible fiction which surrounds them, will in time totally abate the "*Bro in Lav*."

You need journals to portray and describe new inventions and devices that cheapen traffic, lessen liability to accident, and increase the comfort of your patrons, and above all, you require journals to tell you where to get the supplies that you are always needing to maintain your property. Of course those who have goods that are meritorious, goods that have a commercial value, always advertise in the journals devoted to your special business, hence it follows logically that the journal that essays to chronicle your doings is the one for certain manufacturers and dealers to patronise—(terms for space can be had by applying at the office, etc.)

You need journals to chronicle the joy of that ubiquitous organization known as the S. P. C. A. when you lay aside the black snake whip and take up the shovel, slice bar or poker.

You need journals to record the satisfaction which is expressed by your patrons who have nerves, when you relegate your animals to green pastures or the glue factory, and compel "stored up sunlight" to move your cars.

You need journals to impress upon you the solemn fact that you cannot get something for nothing, and thus fortify you against the insidious assaults of would be inventors.

You need journals to inform you of the advances being made in applied science, such as may supplant or take the place of the known sources of power or their practical application.

You need journals to protect you from the insidious assaults of cranks, who with little knowledge fancy they are competent to "revolutionize, etc.," who with wrong ideas as to the conservation of energy, attempt to introduce to your notice and bank account strange devices that are expected to suspend the operation of the law of gravity.

You need journals to notify you promptly when the electric motor has grown to be a Hercules.

You need journals to promptly notify you when a rival line is projected that proposes to capture your traffic.

You need journals to enable you to compare the different values or forms of carbon, the source of all kinetic energy—and help you to intelligently determine whether you will buy oats, zinc or coal.

You need journals to report and preserve the wise sayings, replete with good sense and practical value, uttered by Richards, Holmes, Kerper, Walsh, Richardson, Everett, Johnson, Cregier, Kilgour and many others found among your members.

Gentlemen, the journals we mention are doing all they can to serve you in the hope to secure your confidence, gratitude and ——— I was about to say your money—but we will pass that—and fall back on the gentlemen who advertise.

Finally—Let us hope that cities will grow in population; that the human race will increase rapidly; that houses for trade or commerce will climb higher and higher; that the area devoted to business grow proportionately less; and the area for homes may be wonderfully increased; that the price of the municipal legislator may be lessened—that the gregarious animal may crowd or thicken to his heart's content; that the "welcome news may be telephoned to your hungry ears, as you are attending to the frugal economical dinner you are all accustomed to share with the loved ones about 1:30 p. m.—"25¢ OFFERED FOR CONSOLIDATED, 25¢ ASKED"—then may you wrap the mantle of success about your careworn forms, and exclaim with the old Hebrew—"Truly the good time has come."

This ended the regular programme, but several gentlemen were called upon and made happy impromptu remarks.

Much of the success of the affair is due to the Reception Committee, composed of James Doherty, General George B. Kerper, A. G. Clark and John Kilgour.

Here They Are!

Through a sense of duty, and a desire to gratify our patrons, we take pleasure in announcing that we are able to reproduce, in this issue, the elegant, life-like portraits of some of the magnates who were conspicuous during the convention by their talents, ability and good sense, which were published by that enterprising journal, the Cincinnati *Enquirer*.

We will not say much about the enormous expense which was incurred, or words which it cost us to secure permission to republish this beautiful collection of pictorial triumphs; suffice it to say, that Allan and Mac, yielded to the seductive appeals of the Colonel, gracefully and liberally, for which we here extend our hearty thanks, with the promise that we shall hail with joy the time when they shall grant us the opportunity to reciprocate.

THE PRESIDENT.

Julius S. Walsh (No. 1), President of the American Street Railroad Association, is President of the Citizens' Railroad Company of St. Louis. Mr. Walsh is largely interested in street railroads, and contemplates during the present year changing his line into a cable road. He is one of the youngest members of the association, and is well known by the mercantile community of this city. He is one of the solid financial men of the Mound City, and has a National reputation for energy and business ability.



No. 1.



No. 2.

WILLIAM WHITE.

William White (No. 2), First Vice-President of the American Street Railroad Association, is President of the Dry Dock, East Broadway and Battery Railroad, of New York City. Mr. White takes a great interest in everything pertaining to the street railroad interest, and will not be behind the age on his line. It will in a very short time be reconstructed into a cable railroad. He is a typical New Yorker, and his influence is materially felt in the association. He is an able assistant to President Walsh.

CHARLES B. HOLMES.

Charles B. Holmes (No. 3), Second Vice-President of the American Street Railroad Association, is President of the Chicago City Railroad. Mr. Holmes is the handsomest man in the Association. He built the

finest and most complete cable railroad east of San Francisco, and became so popular that his photographs were on sale in all the book-stores in Chicago. The demand on him to have his pictures taken became so great that he had no time to attend to any other business, so for self-protection he bought up all the negatives and the stock of pictures and used them for fuel on his cable road. They kept the road in operation for fully one month. Since then it has been impossible to procure his picture, hence the blank space below.

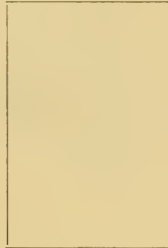

No. 3.



No. 4.

SAMUEL LITTLE.

Samuel Little (No. 4), Third Vice-President of the American Street Railroad Association, is Treasurer of the Highland-street Railroad Company, Boston, Mass.

Mr. Little is largely interested in street railroads and in the manufacture of white lead. He has many friends in this city, who will recognize his pleasing face and welcome him during his stay. He also is a self-made man, and is in no sense a little man, although he is Little by name.

JOHN KILGOUR.

John Kilgour, (No. 5) member of the Executive Committee, is President of the Cincinnati Street Railroad Company. Mr. Kilgour is well known in this city as one of the ablest street railroad managers in the country. He is progressive and aggressive. He will undertake the construction of several cable lines during the coming year. He has closed a contract with H. M. Lane, Esq., to construct under his system of cable railroads, the same as now in operation on the Walnut Hills line. Everybody will recognize his handsome coat in the accompanying cut, which was built especially for the occasion. He will wear it for the first time at the banquet on Thursday night.



No. 5.



No. 6.

THOMAS W. ACKLEY.

Thomas W. Ackley, (No. 6), of the Executive Committee, is President of Thirteenth and Fifteenth Streets Railroad Company, Philadelphia, Penn. Mr. Ackley, with Mr. J. B. Parsons, President of the Lombard and South Streets Passenger Railroad Company, are the only representatives belonging to the Association from the Keystone State. They will be heartily welcomed, and will no doubt bring additional delegations from Philadelphia with them. He has many of the characteristics of a Quaker City citizen, and is one of the solid men of the Association. A combination of brains, energy and thought has forced him to the front ranks of street railroad men of the United States.

THOMAS LOWRY.

Thomas Lowry, Esq., (No. 7), of the General Committee, is President of all the Minneapolis and St. Paul street railroad lines. He began life as a driver, working fifteen hours a day. The balance of the twenty-four hours he devoted to the study of law, being so constituted that he required no sleep. He became noted as the most wide-awake man in the West. From this habit, by rigid economy, he gradually advanced to the head of the road. There being no more room to advance, he branched out for himself and built all the lines in Minneapolis. By living in a hut on the bank of the Mississippi, and con-

fining his diet to fish of his own catching, he saved up enough to buy up the lines in St. Paul. Mr. Lowry was a great friend of our respected fellow-citizen, Charles W. West, Esq., and is well known here. He is now in Europe enjoying life and taking a much needed rest.



No. 7.



No. 8.

MR. SECRETARY.

William J. Richardson (No. 8), Secretary of the Association, is Secretary of the Atlantic-avenue Railroad Company, Brooklyn, New York. The American Street Railroad Association is fortunate in having Mr. Richardson as one of its members. He is thoroughly posted in the affairs of the association, and does all the hard work during its session, and devotes much of his time during the interim. He will be heartily welcomed by all the members and his many friends in Cincinnati, in order that he may be instantly recognized by his many admirers, the above cut of his features is made a part of this article.

C. C. WOODWORTH.

C. C. Woodworth, Esq. (No. 9), of the Executive Committee, is Secretary of the Rochester City and Brighton Street Railroad Company. He is an active member of the association, and is largely interested in street railroads in Rochester. His features show plainly that he is a man of force and character, and his success in life is the best evidence that his energy has been well applied.



No. 9.



No. 10.

JAMES DOHERTY.

The accompanying cut (No. 10), while it does not exactly represent Uncle James Doherty, manager of the Mount Auburn Line of this city, represents one or two of the weaknesses of that gentleman. If he loves anything better than a bottle of choice vintage it is a roast of beef, rare and juicy. He is too well known in Cincinnati to need any description. He first used water power, but forsook it on account of its weakness and went to steam, being the builder and operator of the first inclined plane in Cincinnati. Now he is considering the feasibility of dropping steam and adopting electricity as a motive power. He says he will soon have the best equipped electric railroad in the United States.



No. 11.



No. 12.

CALVIN A. RICHARDS.

Calvin A. Richards, (No. 11) of the Executive Committee, is President of the Metropolitan Railroad Company, Boston, Mass. Mr. Richards is an orator, a scholar and a thorough-going man. When he

speaks the members of the Association must laugh or cry, just as he wills. It is said of him, when his four thousand employees were on a strike, that he called them together, and, mounting a barrel, he spoke with such eloquence of the miseries that followed a strike that at the close every man was ready to return to his work, and would have done so had it not been for a young Irishman who shouted out: "Say, Mr. Richards, if you only paid half as well as you spoke, you'd do —d well." This broke the spell, and the strike went on.

GEORGE B. KERPER.

But this galaxy of railroad magnates would not be complete without the smiling face of President George B. Kerper (No. 12), who is presented in the act of saying to Cincinnati, "All aboard for Walnut Hills via the Cable road." Mr. Kerper has been a citizen of Cincinnati since 1875, and during eleven years has accomplished wonders in the way of rapid transit. He came from Reading, Penn., and is called General, not because he served with distinction during the war, but because he showed his Generalship in resigning the position of high private in a Pennsylvania regiment to accept one as Quartermaster-Sergeant. He always obeyed with alacrity the command to get to the rear in the commencement of an engagement, and his devotion to duty in this respect won for him steady promotion. General Kerper has succeeded in always obtaining for himself a full share of this world's goods, and he has never been adverse to dividing them with his family and friends. He did much to enliven the stay of the visitors, and is invariably regarded as the right man in the right place.

Stop that Car!

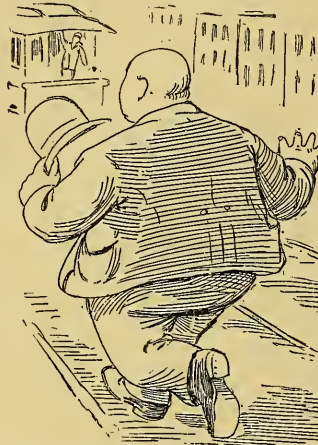

We can not close this truthful report of the convention without reproducing from the *Enquirer* an instantaneous photograph of a well known "heavy weight" as he left the Burnet House, in the vain attempt to visit a friend. The street railways of this Union all know the gentlemanly urbane dealer or vendor of supplies. His elegant manly form is known and admired from the Aroostook to the Rio Grande, and this accurate likeness will

be at one recognised.

Convention Jottings.

A nice point was made by the local delegates at the banquet in distributing themselves among the guests. It was noticed, and the graceful compliment highly appreciated.

Whenever Mr. Calvin Richards took the floor he was listened to with close attention, and his mastery of language held his listeners to the end.

The graceful eloquence of Mr. C. B. Holmes of Chicago, won for him new encomiums as an orator, and his modest and unassuming demeanor made him admired by all.

General Ryan's speech at the banquet was replete with epigram and subtle satire.

The "wily" supply men (as they are called by our V. & S. contemporary of Gotham) were there in force, and seemed to be friends with everybody. Although many of them are rivals in business, yet nothing but good, cordial feeling was manifested, and we hope to have the pleasure of shaking hands with these gentlemen again upon many similar occasions. Long may they live and prosper, for neither the street railway men nor the GAZETTE can afford to lose them.

It would be a fatal error to talk about "inclined plains" to the big-hearted Sup. of the Cinti. St. Ry. Co.

The Local Committee feel more than gratified at the success of the reception and entertainment, also the exhibition of appliances given under their auspices.

The entertainment provided for the visitors on Friday, consisted of a delightful drive in carriages to the Highland House, Art Museum, The Zoo, etc., etc., nearly sixty availed themselves of the tempting invitation, and under the personal escort of that prince of entertainers, Geo. B. Kerper, enjoyed themselves hugely.

Mrs. Dudley Frayser, of Memphis, Tenn., was taken quite sick while at the Zoo, but returned at once to the hotel, and had recovered sufficiently to leave for home on the following morning.

Thanks are due to mine host Zimmerman for his assiduous personal attention to the comfort of the delegates, and if the Burnet House needed any advertising we would give it a clever word ourselves, but it is too well known to require more than a passing mention from us.

Pugh & Russell were well and ably represented by Mr. Pugh, Sr., and his son Mr. John Pugh.

The cable road (which was fully illustrated and described in our October issue) received a pretty thorough inspection, and many who are contemplating cable construction express their intention to adopt the system.

Mr. Simpson, of the Lewis & Fowler Co., was at home with almost everyone present.

The Hon. E. V. Cherry, Sec. of Post & Co., had quite a handsome exhibit of lamps, etc., etc., made by that well known concern.

The car heaters manufactured by the Mich. Stove Co., were much admired, the courteous Secy. of the Co., Mr. Barbour, having them in charge.

The beautiful car belonging to the Northern Central Ry. Co., of St. Louis, and built by the Brownell & Wight Car Co., was placed on the outside of the hotel, and was unanimously voted a model of beauty and elegance.

Our old friend Aug. Day of Detroit had some of his goods on hand.

Messrs. Beadle and Courtenay of New York were both present.

Friend Littlefield, who is too well known to require any introduction, had an amiable word for everyone.

The old familiar face of John Reynolds of New York adorned one end of the banquet table.

The Johnson Steel Street Rail Co. had two able representatives attending the convention.

Mr. H. A. Everett of Cleveland, accompanied by his charming bride, attended the convention, and, with a party of four or five, left for the Mammoth Cave on Saturday.

Our old friend Bowler, of Cleveland, was there with a new car wheel. To replace a worn out "tread" only requires a "Barn-land" with a monkey-wrench. It was appreciated.

Convention Notes.

\$125,000,000 of capital was represented.

Horse sense was perceptible in all that was done.

Every delegate went home with increased knowledge.

President Walsh is deservedly popular. He earned every compliment the delegates showered upon him.

Richards, of Boston, has a sure thing on conductors. He allows the Y. M. C. A. to fill all vacancies.

The Burnet House made everybody comfortable.

The supply dealers were there in force; the halls and billiard rooms were a young exposition.

The banquet was a complete success.

Henderson, Stone and Kilgour did their part in fine style at the eastern end.

The beautiful smile that illuminated the beard and features of Bolly Lewis when he entered the dining hall, was evidence that the prince of caterers knew that he had achieved another victory.

The ubiquitous Kerper was there.

The dignified Kilgour was there.

The general Clark was there.

The venerable Doherty was there.

The field marshal was there.

The line corporal was there.

P. G. was *not* there—alas!

That distinguished military orator, Gen. Ryan, will soon emigrate to Alaska, to avoid becoming one of "our passengers."

Philadelphia will next entertain the Convention.

The good sense and eloquence of Holmes was enjoyed by all.

No one will forget the "invite" of President Ackley, it means that Philadelphia intends to do something in 1887.

"Cincinnati Soots," said Richards of Boston, "but beneath the smoke, cinders and fog of your city are the whitest souls I have ever met."

Chicago has Holmes, Cincinnati Kerper, two Napoleons.

Merrill of Boston voiced the real sentiments of "Our Guests."

Electricity was cautiously handled, all who took part in discussing it, were careful to *insulate themselves*.

"Grips" were as plentiful as autumn leaves, when it was time to separate.

Doherty prophesied, he gives the cable a short reign.

The Toast-master was in doubt at one time, as to which end was in front, Conductor Kerper gave him the information he called for—"Both ends!"

The remarks of the First Vice-President were not heard by our reporter.

The Hon. Allan O'Enquirer, beg pardon! we mean the Hon. Enquirer Myers—no—hang it! we mean the managing editor of the *Enquirer*, came near holding a "Democratic Rally," but he was switched off before any mischief was done.

That increase of \$17,000,000 traffic in one year was a surprise to the "mule drivers."

The trip over Kerper's Cable Line was a surprise to many.

H. M. Lane, the constructing engineer of the Cable Line, was highly commended for the valuable improvements and economy he had inaugurated.

Doctor A. A. Everett of Cleveland was observant and as usual watching for the new and meritorious devices.

The ease with which the cable cars turned the short curves satisfied the delegates that Lane, though young, has achieved a great success.

The carriage ride on Friday was enjoyable.

The call at the art museum was short, but Kerper "did not bring them there to *study* art, only to *see* it."

"A fellow feeling makes us wondrous kind." So thought some of the visitors at the Zoological Garden.

\$60,000 per mile double track *vs.* \$120,000—"we improve!"

Corporal O'Myers caused happiness to cover Cincinnati when they learned from his truthful lips that the hatchet was buried "blade, handle deep." Sweet peace reigns once more. Hurry up the Corryville cable!

A few invited guests, who buy by the acre, and sell by the foot, applauded Gen. Ryan with much vigor.

STEEL RAILWAY TIES.—In view of the rapid extension of the use of steel in this country, for street and other railways, the statement of the *Mexican Financier* of the experience of the Mexican (Vera Cruz) Railway Company during the past two years with steel railway ties is of special interest: "The road began using steel ties in 1884, and has now some 20,000 of them on its bed. So satisfactory has the experiment been that 40,000 more have been ordered from England for use this year, and it is proposed to put in from 40,000 to 50,000 per year hereafter. The 'life' of a steel tie is considered as indefinite, but it may safely be set at from thirty to fifty years, the former being an American estimate by a competent metallurgist. The steel tie is now produced in England—where the manufacture has been so extended as to make the production very much cheaper than formerly—for 5s. apiece, or \$1.25 gold. By chartering its own vessels the Vera Cruz Company can land its steel ties at a cost which permits their extensive use. It may be set down that the outside cost will not exceed \$2 each, Mexican silver. The wooden ties which the steel ties are replacing on the Vera Cruz line range in price, according to the quality of wood, from 90c. to \$1.62, silver. The latter price is paid for the zapote tie, a very hard and durable wood. The best white oak ties last from five to six years, the red oak about three years. In India the steel tie, sent out from England, is displacing even the teak tie, one of the best woods, and the change is being made on the score of economy. In using the steel tie the expense of spikes is saved."

THE
STREET RAILWAY GAZETTE

NOVEMBER, 1886.—MONTHLY, \$2.00 PER YEAR.

COPYRIGHTED NOVEMBER, 1886.

PUBLISHERS:

THE WRIGHT-MONROE COMPANY.

| | |
|--------------------------------|------------|
| Augustine W. Wright, - - - - - | President. |
| E. V. Cavell, - - - - - | Secretary. |
| S. L. K. Monroe, - - - - - | Treasurer. |

GENERAL OFFICES:

CHICAGO, - - - - - NEW YORK, - - - - - BOSTON.

CHICAGO,

43 LAKESIDE BUILDING.

| | |
|---------------------------|------------------|
| P. G. Monroe, - - - - - | General Manager. |
| G. G. Minor, - - - - - | } Editors. |
| William Hughes, - - - - - | |

NEW YORK,

181 BROADWAY.

Henry C. Lockwood, - - - Resident Editor and Manager.

BOSTON,

198 WASHINGTON STREET.

T. P. Pemberton, - - - Resident Editor and Manager.

BRANCH OFFICES.

PHILADELPHIA, Pa., 24 N. 4th St., A. G. Judd, Manager.

ATLANTA, Ga., Chamber of Commerce Bldg., Wm. Minnigerode, Manager.

SAN FRANCISCO, Cal., 1322 Pine St., G. W. Fairchild, Manager.

The fifth Convention of the street railway managers of the country at Cincinnati last week is only another evidence of the advantage to those engaged in a similar business or occupation—coming together occasionally and comparing views, experience and practice. At this Convention there was one feature that was prominently brought to the attention of visitors, namely the display of strong practical sense displayed by the delegates. When it is remembered that the delegates were men who had been selected by invested capital to fill their several positions, it is no wonder that the Convention was entirely made up of successful men, men who with correct views of business, having ability, with approved character and habits, and possessing capacity for administration, brought into the Convention all the qualities that have secured for them the confidence and esteem of the companies they represented.

It is not surprising that their session was a success, that the papers read would have been a credit to bodies who make greater pretensions to learning and scientific attainments, and the full report of the meeting is but additional evidence of the growing tendency to employ first-class successful men, where only economical and intelligent management will secure dividends upon invested capital.

Genesis of Street Railways in Chicago.

The business man who takes the street-car every morning at his door and is wafted with more or less celerity to the scene of his daily toil in the service of Mammon seldom gives a thought to the importance of the street-railway system and its value as a factor in the city's domestic economy. It does not require the memory of the oldest inhabitant to recall the time when a single track on State street was the city's solitary accommodation for public passenger transit, and the cars were not much superior to those in use in the smaller Southern cities, where a dry-goods box, a mule, and a Mexican driver comprise the paraphernalia requisite for public traffic and the cars run from one end of the town to the other three times a day. That was in the days when State street was paved with cobble-stones and the adjacent thoroughfares with mud of assorted hues and varying degrees of stickiness; when on most streets the

sidewalk before each house was graded at its own particular altitude.

But the public sentiment toward a corporation has not altered a great deal, and property owners on State street made in 1856 the same objections to invading tracks that would be raised by the present residents of Prairie or Dearborn avenues to a similar encroachment. When, in 1856, an ordinance was passed granting to R. B. Mason and Charles B. Phillips the right to lay a track or tracks from the corner of State and Randolph streets to the southern city limits, and from the corners of Kinzie and Dearborn and Kinzie and Franklin to the northern city limits, with connecting intersections, while general public sentiment favored the measure the residents of the streets on which it was proposed to lay the tracks raised many dissenting voices. The principal line was to be that extending down State street to the city limits. Little was accomplished, however, beyond the laying of a short section of track on the North Side. Then came the panic of 1857; business was at a standstill, and all enterprise was temporarily enervated. Col. Mason became interested in the construction of the Illinois Central railroad, and, tiring of the delay in accomplishing the work of putting through the city railway scheme, he sold out his interest in the charter to Mr. Phillips, who devoted his energies to the consummation of the original plans, although encountering in the establishing of his claim many opposing legal technicalities. Until the summer of 1858 the street railway matter remained in a state of coma. Then the Council revived the subject and passed a new ordinance, granting to Frank Parmelee, Liberty Bigelow, and Henry Fuller the right to lay tracks on State street, Cottage Grove avenue, Archer avenue, and Madison street to the city limits. The ordinance stipulated that at least one of the prescribed lines was to be commenced by Nov. 1, 1858, and that the State street line must be completed to Twenty-second street by Oct. 15, 1859. Twenty-second street, by the way, was then called Ringgold place. Other specifications provided for the finishing of the Madison street line by Oct. 15, 1860, and the Cottage Grove line by Jan. 1, 1861.

Work was then begun in earnest, attention being first directed to the State street line, and the first rail was laid Nov. 1, 1858, near the corner of Randolph and State streets. These initial labors were attended by considerable ceremony. Ex-Gov. Gross drove the first spike, and Henry Fuller and other well-known citizens participated zealously with spades and hammers. When the track was extended two blocks a couple of cars were brought from Troy, N. Y., and run between Randolph and Madison streets, to the satisfaction of the company, but the derision of the public.

In January, 1859, the Chicago street railway enterprise was confirmed by the Legislature, which, by an act approved in that month, incorporated the Chicago City Railroad Company, consisting of Franklin Parmelee, Liberty Bigelow, David A. Gage, and Henry Fuller, authorizing them to operate lines in the South and West Divisions for a term of twenty-five years.

State street, from Madison to Twelfth, was then a busy thoroughfare, and beyond Twelfth the street was undergoing transition from a residence to a business locality. Consequently the residents of that portion of the street were loth to give the company the required consent to the laying of the tracks, and exorbitant terms were frequently demanded for the necessary permission of property holders, who were not slow to recognize the hold given them on the company. This retarded progress somewhat, but the line was opened to Twelfth street April 25, 1859. State street was then paved with cobblestones to Twelfth street, and beyond that thoroughfare a plank road extended to Cottage Grove, which suburb was afterward known as Camp Douglas, and was the scene of many interesting incidents of the war-time.

In June, 1859, the track was extended to the city limits. Those who now complain that there is an insufficient number of cars would have had their patience much more tried by the then existing state of affairs, as cars were run only every twelve minutes; but the people were thankful for

small favors. Soon afterwards, however, the intervals between cars were reduced to six minutes. During the summer the line was extended on Cottage Grove avenue to Thirty-first street, and when, in the following autumn, a State Fair was held at Cottage Grove, rails were spiked down upon the plank road and cars run out to the fair. The new line met with such success that the Council passed an ordinance providing for additional tracks to be laid upon Lake, Randolph, and VanBuren streets and Milwaukee and Blue Island avenues, stipulating the time at which each of the new lines should be completed. No tracks were laid on Clark street, owing to the fact that below Harrison street Clark was occupied by the Michigan Southern railroad. Ten years' time was, therefore, allowed the street railway company to construct a line on Clark street.

Meanwhile work had been going forward on the Madison street line, which was opened to Halsted street May 20, 1859, and in August of the same year West Siders could ride as far as Robey street, while during the same summer the Randolph street line was made ready for use.

In 1861, the scarcity of silver coin made it necessary for the company to issue punch tickets, people finding it inconvenient to pay their fares in postage stamps. At this time the company constituted a sort of local mint, and in the dearth of small change the street car tickets made as good currency in Chicago and vicinity as coin of the realm. The most popular bit of scrip was an uncanceled ten ride ticket, which was gladly accepted at its face value—50 cents. They were received at all the local stores, and not infrequently found their way into the contribution plates of the churches. The simplicity of the designs of these tickets caused them to be extensively counterfeited, so the company called in all the tickets of 1861 and issued others of more elaborate and less-easily imitated pasteboards. For convenience in circulating, this second issue was made to include 10, 15, and 25 cent tickets, and they continued to be used as currency until the Government issued scrip and postal currency in 1862. For months after these tickets had ceased to serve as currency the company was made the recipient of tickets sent from neighboring cities, which were duly redeemed.

In 1863, Thomas Harless, H. A. Hurlbut, Charles Hitchcock, and others formed a company, called the Wabash Railroad Company, for the purpose of constructing city railway lines on Wabash avenue, Michigan avenue, and other prominent streets. This organization was incorporated in January, 1863.

The Chicago City Railway Company continued to extend its lines in the South Division. In October, 1864, tracks were laid on Archer avenue from State street to Stewart avenue, and the next year the line was finished as far as Bridgeport. At the beginning of the year 1870 the company owned and operated between seventeen and eighteen miles of track, and cars were run on State street, from Randolph to Twenty-second, every minute. The company was quick to recover from the losses sustained in the great fire, the loss being principally in the damage to tracks in the burnt district.

The next important move of the company was the introduction of the cable cars. Excavations for this introduction were begun in August, 1881, and the first train was run early in 1882.

Mr. Charles B. Holmes, the present Superintendent and President of the company, has been identified with the road since 1873, first in the capacity of Superintendent and then as President. Mr. Holmes is a native of Vermont, passed his early days in Massachusetts, and came to Chicago in 1856. He is a shrewd, practical, and far-seeing business man, and his influence has shaped the policy of the company of late years.

A PETROLEUM ENGINE.—An engine, specially constructed to use petroleum as fuel, is successfully operated between Alexandria and Cairo. It is estimated that a total saving of \$250,000 in fuel in a year would be effected by this railway by the substitution of petroleum for fuel.

A Steam Brake.

The North Hudson County Cable Railroad Company also maintain an inclined plane cable road for raising and lowering horse cars and road equipages.

In stopping the hoisting drum a reliable brake was found to be absolutely necessary, and, among other devices, an air brake was procured, which required a $1\frac{1}{2}$ " steam connection with the boiler to enable the brake to work properly.

Ordinary mechanical methods of applying the brake not proving satisfactory, and the air brake being too expensive, a steam brake was devised by Thomas Strickland, which has done and is doing the required work well and with economy, and only using such steam as can pass through a $\frac{1}{2}$ " globe valve, open $\frac{1}{4}$ of a turn.

This brake consisted of the usual strap, toggle joint and lever, the end which the steam operated having a movement of about 26 inches.

The cylinder was $4'' \times 28''$, perpendicular, and the stuffing-box was made $6''$ long in order that it might serve as a guide to the piston rod, and dispense with crosshead.

The connecting rod, about $8''$ long, was welded to the piston, and attached by a pin to a slot in brake lever.

A plain slide valve was used as a throttle, and was connected by a rod and lever, with the starter's room above.

When the brake is to be applied the piston must be lowered. The end of the slide valve, which governed upper end of cylinder, was cut in plan like the letter **V**, thus forming a simple graduated valve.

The center of the valve is cut back, thus permitting the edges to cover the port first; the ports are about $\frac{5}{16}$ " wide and $2''$ long.

The connection between steam chest and bottom of cylinder is through a very small pipe, less than $\frac{1}{4}''$, thus delaying exit of exhaust and forming a cushion as the piston is forced down when the brake is applied.

"THE SIDEWALK STROLLER" seems to dread winter, as Cæsar dreaded the Ides of March. As the fall approaches, my mind, says he, runs a good deal on the unpleasantness of street-car travel in cold weather; and one of the most needed improvements in these rolling instruments of torture concerns their doors. One of the things that shortens life in a city is the incessant banging of the street-car door in the winter. These doors are slid open by the conductor every time the car passes a corner, long enough to call the name of the street, and then shut again. This entails on passengers the double nuisance of the noise and the blast of cold wind. That this nuisance should have been endured so long and so meekly is a startling illustration of the slowness of the march of mind. It might easily be cured, as I have often remarked to Mr. Holmes, Mr. Hough and Mr. Yerkes, by moving the usual hand-hole and slide from the lower panel of the doors up to the point on a level with the conductor's mouth. If this trifling change were made, not only might the streets be called without opening the door, but the fares could be handed through the hole with double the ease that they are now. This change might reduce the amount of glass in the door somewhat, but this would be a very slight disadvantage compared with the comfort secured by the change.

New York and New England.

The following explains itself: There is not one word of truth in the report on the Stock Exchange that the Manhattan Railroad Company is going to consolidate or merge itself into or with the New York City & Northern Railway Company, or with New York & New England Railroad Company, or either, and these reports are started merely for speculative purposes. I know of no director of the Manhattan Railway Company who is in any way interested in the New York & New England Railroad Company.

(Signed) R. M. GALLAWAY,
Vice-President Manhattan Railway Company.

The great question.—Shall the cars be heated?

History of Street Railways.

(Continued.)

II.—RAILROADING. FIRST TRAMWAYS IN AMERICA.

The laying of rails, for wheels to run on, to convey heavily-loaded vehicles along a road or way, was the next development leading to the conception of street railways. They were at first called Outram-ways, and subsequently, *tramways*; the name being derived from Mr. Outram, a gentleman extensively connected with the collieries at Newcastle-on-Tyne, says Tomlinson. We have an account of road-rails or tramways dating as far back as 1670, when, on the introduction of coal as a substitute for wood fuel, great difficulties were experienced in carrying the black fuel from the mines to the ships, which was done in rude carts over rough roads, involving serious expense to the mine owners, and several hundred horses and carts were employed in conveying a comparatively small quantity of coal.

"The importance of adopting some plan of reducing the consequent expense occupied the attention of those interested, and, after serious consideration, the result was the construction of wooden tramways, consisting of straight pieces of timber imbedded longitudinally in the roadway without cross ties." The plan was soon adopted in all mining districts, and gradually those primitive railroaders learnt to level the road-bed, and to cut cross ties of large logs of wood into lengths to correspond to the width of the road, laying them across at short distances, firmly imbedded, to support the longitudinal pieces of timber which were connected end to end over the cross ties, and to which they were nailed or otherwise secured.

"The roadway was generally about six feet wide, the cross ties were laid two feet apart; the under rail was first laid with oak, but afterwards of pine fir, about six feet long, five inches broad, by four or five inches in depth; the upper rail was of the same dimensions, and generally of beech or plane tree; the under rail being properly secured to the cross ties, the road was ballasted with ashes or other material, packed firmly to the surface of the rail, upon which the upper rail was then placed, and firmly secured by wooden pins."

The wagons then in use were proportionately clumsy, very low, and with wooden wheels. "The passage of the wagons over the steep declivities, or runs, was regulated by rude brakes, the management of which, depending upon the dexterity of the wagoners, often produced very fatal results."

About the year 1767—after the wooden rails had been in use nearly a hundred years—it happened to be discovered that iron rails would render far better services. At the period in question the Darby's of the Coalbrookdale Iron Works (Shropshire, England) introduced iron rails into their service, somewhat in this fashion:

"It is said that, the price of iron becoming very low, and the works of this company being of great extent, the pig iron, instead of being stacked, was laid upon the wooden rails, on the supposition that the saving in repair of the rails would help to pay the interest, until the price of iron should rise, when it could be easily taken up and sent away as pig iron. These pieces of iron were about five feet long, four inches broad, and one inch and a quarter thick, with three holes by which they were fastened to the rails. The introduction of the iron rail so reduced the resistance in descending inclined planes that the brake was ineffectual in counteracting the force of gravity, and recourse was had to other modes of restraining the velocity of the wagons, which resulted in the employment of the surplus gravity of the load descending one plane to drag the empty ones up the ascending plane."

So reads the account, as quoted. It was not long until cast-iron tram plates with an upright ledge were adopted. That was about the year 1776. "Since then the subject has so occupied the ingenuity of mechanics and engineers that a great variety of patterns for iron rails have been patented and introduced"—to which further reference may be made in a subsequent chapter.

The idea of using tramways for the conveyance of passengers seems to have first occurred to a Mr. Edgeworth, in 1802. He published a pamphlet showing the practicability of rails being "laid along turnpike roads for the use of stage-coaches, which might be made to go at six miles an hour, with one horse." A certain Dr. Anderson also became very full of the subject, and passenger tramways became a familiar subject, in theory.

The next important advance toward the invention and adoption of street railways, and what, in fact, may be taken as the first street railway, without begging the question hardly at all, was the opening of the Stockton and Darlington Railway, in England, in 1825. On that occasion "animal power was principally employed, and the community was surprised at the wonderful superiority of railroads over the best of common roads; as a carriage containing twenty-six persons, with their proportion of baggage, was drawn by a single horse at the rate of six miles an hour, with comparatively little exertion." The first train, however, consisted of thirty-four vehicles, making a gross load of about ninety tons, which was drawn by one engine driven by Stephenson, with a signalman on horseback in advance. "The principal business of the new railway was the conveyance of minerals and goods, but, from the first, passengers insisted upon being carried, and in October, 1825, the company began to run a daily coach, called the 'Experiment,' to carry six inside, and from fifteen to twenty outside, making the journey from Darlington to Stockport and back in two hours," the fare being one shilling (equivalent to 25 cents).

It was in the following year (1826) that the first "tramway" was laid in the United States, according to one well-known authority. That was called "the Quincy Railway" (although it was not a railway, in the proper sense of the term, until 1871.) Charles Francis Adams (the younger) says that "This road, known as the Granite Railway, was built by those interested in erecting the Bunker Hill Monument, for the purpose of getting the stone down from the Quincy quarries to a wharf in Neponset River, from which it was shipped to its destination. The whole distance was three miles, and the cost of the road was about \$34,000. At the quarry end there was a steep inclined plane, up and down which the cars were moved by means of a stationary engine. From the foot of that incline the road sloped gently off to its river terminus. There was nothing in its construction which partook of the character of a modern railroad. The tracks were five feet apart. On this stone substructure wooden rails were laid, and upon these another rail of strap iron. Down this road two horses could draw a load of forty tons, and thus the expense of moving stone from the quarries to the river was reduced to about a sixth part of what it was while the highway alone was in use.

"Such was the Quincy railway, the construction of which is still referred to as marking an era of the first importance in American history. Such, also, it remained down to the year 1871—a mere tramway, operated exclusively by means of horses. In that year the franchise was at last purchased by the Old Colony Railroad Company. The ancient structure was completely demolished, and a modern railroad built on the right of way.

"Through the incorporation into it of the old Granite railway, therefore, the line which connects the chief town of what was once Plymouth Colony with the chief town of what was once the colony of Massachusetts Bay, has become the oldest railroad line in America. In this there is, so to speak, a manifest historical propriety."

It may be worth observing here that Dr. R. P. Robins read a paper on

THE FIRST PERMANENT TRAMWAY IN AMERICA

at a recent meeting of the Philadelphia Engineers' Club, wherein it is declared that a tramway was projected by Thomas Leiper, of Delaware County, Pennsylvania, in 1809, for the transportation of stone. That was 17 years prior to the Quincy Railway—which, indeed, is placed fourth as to date in Dr. Robins' paper,—and there is a strong corrob-

oration of the correctness of this statement in the fact that Leiper advertised in the *Aurora* of September 28, 1809, as follows:

"I wish to contract for the digging part of a railway, from my quarries on Crum creek to my landing on Ridley; the distance and level has been accurately ascertained by Mr. Reading Howell. The distance is exactly three-fourths of a mile, and an accurate statement of the quantity of digging required may be seen from the plot in my possession, calculated by Mr. Howell. I also wish to contract for making and laying the rail part of the same, consisting of wood, a specimen of which, as furnished by Messrs. Large & Wimpenny, may be seen by applying to them at their manufactory, adjoining the Bull's Head on Second street, in the Northern Liberties. The scantling for the above will be furnished on the ground. I wish to progress in this work immediately."

He had previously experimented as to the feasibility of such a tramway, in the yard of the old Bull's Head tavern, Second street, Philadelphia. And the roadway in question was completed early in 1810, in accordance with a draft prepared by one John Thompson, and continued in operation until 1828—about two years after the construction of what Charles Francis Adams speaks of as the first tramway in the United States. This Crum-Ridley tramway was superseded, in 1828, by a canal, and nothing remains of this "first permanent tramway" except the deep cross-tie cuts.

This, however, was not the first tramway in this country, according to Robins. As far as he "can arrive at any conclusion upon the subject," New England had one about a quarter of a mile long, on the western slope of Beacon Hill, designed and constructed by Silas Whitney, in 1807, which was used to carry gravel from the hill-top to fill up and grade Charles street, Boston. This road was also but temporary, and its occupation was gone, and its rails were taken up, as soon as Charles street had been properly graded. The next tramway, in the Robins paper, in point of date, was laid in Nashua, N. H., in 1825—the same year in which the Stockton and Darlington Railway was opened in England.

The modern tramway, or street railway, was first adopted in the United States, "where, owing to the badness of the roads, and the long distances to be traversed, a rapid means of transport was the first necessity to the pursuit of business," and thereby the practical application of the tramway system took place. And it is universally conceded that "America is essentially the land of tramways." England comes next. All the rest are nowhere; although a tramway had been laid down and put into operation, for goods and passengers, between St. Etienne and Andreziense, in France, as well as one between Budweis and Linz, in Germany, prior to 1830.

The New York and Harlem line was opened in 1832, but did not meet with favor, and was for a time suppressed. In 1852, however, M. Loubat, a French engineer, laid down a tramway in New York, consisting of rolled iron rails, placed upon wooden sleepers. The rails had a wide groove in the upper surface, and were similar to those afterward laid down by the same engineer in Paris. Tramways had by this time become so essential to New York that the objections made to them by the proprietors of other vehicles were disregarded, "and they multiplied rapidly, not only in the Empire city, which owes most of its amazingly rapid development to them, but in the principal towns of the States."

In 1856, a Mr. C. L. Light, an English engineer, laid an improved tramway in Boston, in which the depth of the groove was only $\frac{3}{4}$ inch, while the inner side of the rail formed a flat slope. The Philadelphia step rail was also an improvement, dispensing with a groove altogether, but having a ridge at one side against which the wheel-flanges ran. It answered its purpose well; but when introduced to England by Mr. Train it was speedily condemned, and the lines laid by him at Birkenhead and the Potteries were only saved from suppression by the substitution of flat-grooved rails of the kind with which we have since become familiar.

To be continued.

Form of Street-Car Bodies.

The remark recently made by a large holder in street-railway stock, that he saw no reason why the next lot of cars which he intended to purchase should not have the same shape as those of the new Broadway road, is very suggestive. These new cars have very straight sides, and even to an inexperienced person present a striking contrast to the more common form. The fact that so important a road has adopted such a style, has its influence in setting a fashion. This was, no doubt, the reason for the remark.

It should be generally understood that the straight body has been adopted to a certain extent under protest. Broadway is a comparatively narrow street, and is crowded with business. It was therefore necessary to give the traffic as much space as possible by crowding the car-tracks. This having been done, it was found that the standard body which had for years been used on most of the roads in the city, was so wide that a man could not stand between the tracks when the cars were passing. A narrower body was in consequence adopted, and the shape had to be modified accordingly. The new cars cannot be as strong nor as durable as those of the more common style, and they are certainly much less convenient and comfortable, on account of the reduced width.

The body of a horse-car is built upon principles similar to those applicable in coach-building. While both the street and steam cars were originally modeled upon the lines of a coach-body, the steam-car, in its framing and distribution of materials, has departed radically from the original pattern. The horse car has to resist twisting and racking strains coming from almost every direction, and is called on to carry loads greater than its own weight. The passenger-car on steam roads carries a load which is small as compared with its own weight, and has principally to resist severe endwise strains to which the street-car is never subjected. The load of an ordinary day coach on a steam road is rarely as heavy as that which may be found on almost any full-sized street-car in New York City in the "commission" hours of the evening. In one case the car is six or seven times as heavy as its load, in the other the load may be twice as heavy as the car.

To meet the conditions of street traffic, cars must be light and strong. Lightness is indispensable, because the motive-power limits the total load. After selecting our materials with a view to strength and lightness, it is found that the cylinder or globe present forms having the greatest strength in proportion to the quality of material employed. It is, therefore, best to add to material resistance of panels and posts that which may be gained by making the body convex or concave. The convex portions become so many arches to resist a change of shape. The panels are made concave or convex, as the case may be, to fit the frame. They are covered on the inside with a coarse, strong canvas or "scrim," glued fast to both panel and the posts to which the panel is attached. But this is not all. The panels are usually set in glue or lead in addition to the screws or nails by which they are held. Stays or strips of wood are glued upon them, which reinforce them and greatly increase their strength. Strong but light bracing, with rods and plates of iron and pockets for posts, hold these arches in place.

When, however, the peculiar shape of the car-body is abandoned, the advantages of the arch are lost. Straight panels have to depend upon the tenacity of the wood and canvas alone. The framing in the same way suffers a loss of stiffness. It can no longer withstand all kinds of strains without yielding. This is not a theoretical result, but one which has been taught by experience. Many years ago a road not far from New York City built its own cars, and fixed upon a form of body having almost straight panels. The bodies soon began to show signs of weakness, and, long before it was expected, the cars were fairly racked to pieces. As soon as the frames began to "work" or move, it was practically impossible to keep the roofs tight, and decay of the posts followed quickly. It is needless to say that the straight-sided cars were replaced by others of the ordinary form.—*American Railroad Journal.*

Noiseless Steam Motors for Street Railroads.

The annexed engraving represents a steam motor for street railroads which, in general form and construction, does not differ greatly from the ordinary horse car. Indeed, the body of the car is just the same, the forward part having a semi-circular form, gives a neat finish and appearance. It is here that provision is made for the motive machinery, which consists of two small horizontal engines connecting with cranks on the forward axle of the driving wheels. The boiler may be of the ordinary vertical type, or the Duval water-tube boiler may be used advantageously, as it is claimed that this boiler weighs less by one-half than any other of the same capacity. It will be noticed that there are a single pair of driving wheels of larger diameter than those on the rear swinging truck with four wheels. This, while giving a six-wheel base to the car, allows it to move easily round sharp curves.

Therefore, in introducing the mechanical arrangement which renders the motor noiseless when in motion, it is not necessary to construct new cars of a different design; the present horse cars can be retained with a slight addition in front, as shown, and provision made for the forward wheels and rear truck, which would be so simple as not to require explanation here. The device for rendering the car noiseless is found to be thoroughly practical and efficient. It is the invention of W. E. Pearson, president of the United States Pump and Valve Co., of Boston, Mass. The improvement consists in disposing of the exhaust steam in such a manner that it cannot be heard, and condensing it in such a way that it is used to feed the boiler with hot water of a high temperature. The arrangement is simple and economical. What is effected by circulation in a hot water apparatus is similarly done, in this case, with steam. The exhaust steam, as it leaves the engine cylinder, passes first into an injector, which throws it into a receiver, where the exhaust is absorbed.

By this simple arrangement of an injector with small tanks and pipe connections, the exhaust steam is condensed and utilized as feed water, and after accurate tests shows a gain, it is said, of 38.2 per cent. over the Hancock inspirator when used for feed water to boilers.

As iron sharpeneth iron so do the faces of friends.

Improved Lamps and Lamp-Holders for Railway Cars.

The improvements in lamps and lamp-holders for street and elevated, and surface railroad cars have received of late more than ordinary attention from superintendents and purchasers of railroad supplies and fittings; for the lighting of cars has become not only an important consideration to railroad companies, but also to the traveling public, who require and naturally expect a clear and bright light that will allow them the perusal of books or newspapers and add to the cheerfulness of the surroundings. To travel all night in a poorly-lighted car, or even to travel a short distance in a car having a flickering, feeble light and a smoky chimney, is the acme of unpleasantness for the senses. We most of us know what dull light and smell of oil and smoke will do for bad ventilation as well as bad temper and restless discontent.

The improvements illustrated here have been invented with the object of providing a strong, substantial lamp and

lamp-holder that can be strongly secured, handled easily, filled readily and nicely adjusted; free from vibration when the car is in motion, and that are also ornamental and unique in appearance. The principal and most excellent feature of the improvement consists in the form and placing of the reservoir which holds the oil. This is illustrated by Figs. 1 and 2. Fig. 1 shows a lamp and lamp-holder complete, secured to the roof of a Monitor roof car and the reservoir in place. This engraving shows also how the device can be suspended or hung from inclined or sloping surfaces, in a neat and simple manner. Fig. 2 shows the reservoir removed from the supporting frame or bracket, and how easily it can be slid in and out, how it can be filled and the wick adjusted. It can be re-filled and trimmed from the floor, without steps or getting on the car seats.

Fig. 3 represents two lamp bodies or lamps. It will be seen that the lamp-holders and bodies admit of the adaptation of the sliding reservoir. The stay-rods allow the whole device to be firmly fastened to the center of the roof of the car, and the lamps having shades, they throw a soft and pleasant light where most wanted.

Letters patent were granted for these improvements Sept. 14, 1886. They are of such a character that they will commend themselves to the attention of railroad companies,

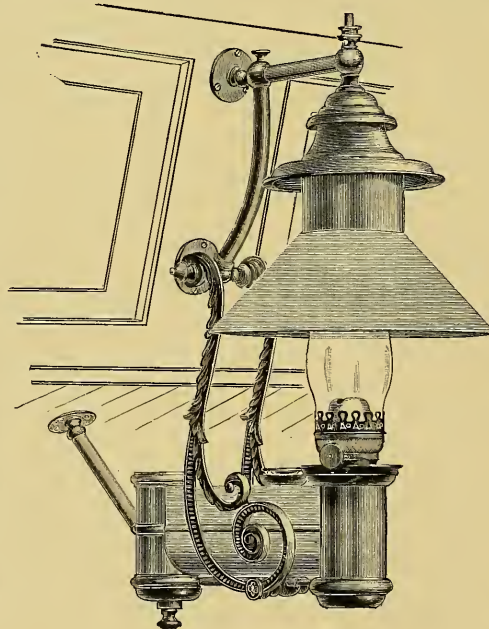
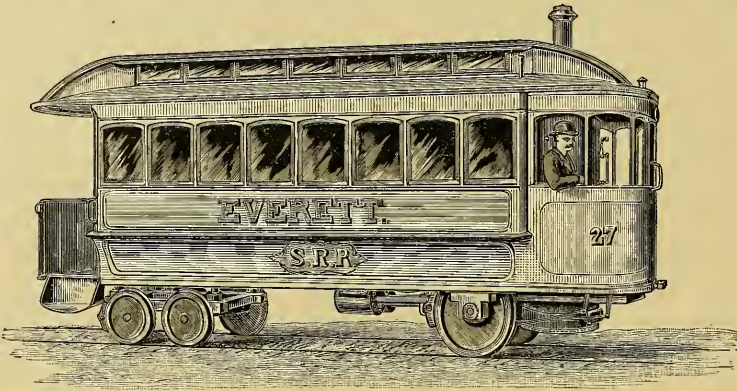

FIG. 1.

Save the Horses.

A USEFUL AND HUMANE IMPROVEMENT IN COLLARS, HARNESS-SADDLES, ETC.

We recently had our attention called to an improvement in the padding for harness-saddles and horse collars, now being introduced by The Vulcanized Pad Company of Boston, Mass. It is the invention of James P. Miller, an experienced harness maker, who has been granted, during the present year, letters patent in England and this country.

The object of the improvement is to prevent the skin chafing, and irritation and sore-making, so frequently caused by the present form of horse-collars and harness-saddles. Heretofore harness and saddle pads and linings have been made with a facing of india-rubber, or cloth, or leather stretched over some elastic material or filling behind it. This leather or cloth facing being porous, absorbs the perspiration of the animal so that when dry, the pad becomes hard and stiff, especially at the points where it absorbs the most perspiration, thus forming lumps or hard spots, more liable to abrade the animal than other parts of the pad, and causing the latter to bear unequally. When the india-rubber facing

is used with pads, endeavors are made to give the pad the form of the animal, on its bearing surface upon the latter, by stuffing it inside with some elastic material; but this involves the stretching of some parts of the india-rubber facing more than others, and although it does not absorb the perspiration, yet the parts of the facing the most stretched are not only less elastic in themselves than other parts, but they compress the elastic filling material behind them harder than at other parts, thus forming these parts of the pad into lumps which abrade the animal.

To overcome these and other difficulties, the inventor has introduced an elastic water-proof pad, substantially alike in elasticity over its entire surface, which bears evenly upon those parts of the animal it touches, and does not chafe or abrade the skin in one part more than another, thus avoiding all injury to it.

Horse Shoeing.

How to secure good "understandings" for a horse—especially the intelligent animal that draws the street railway cars—has been and is an important question, which many are endeavoring to solve. The West Division Railway

Co. of Chicago extends over forty miles of road, all double track, on which nearly seven hundred cars are running, and close upon four thousand horses are employed. It is, therefore, of the greatest importance to them to have their horses shod in the best manner possible. The foreman of their horse-shoeing department (Mr. Leggett) has explained to the readers of this journal (his communication was published in the GAZETTE for January last) the advantages of the Goodenough shoe; but we understand that further experiments are being made.

Many other companies, employing immense numbers of street railway horses, are extremely anxious

to find out the proper method of horse-shoeing, to secure comfort and long life to their beasts of burden, or, speaking more correctly, their draught animals. The same problem has agitated the minds of those interested in the welfare of the horse, on the other side of the Atlantic for a considerable time. "Impecunious" says there is too much sameness about all existing writings on the horse's foot, and that *original* ideas are wanted. And "Free-Lance" has declared that "Literary shoeing smiths do not frequently appear among us [in England]; but America, as usual, has been able to 'supply this long-felt want' in the person of Mr. Russell. He writes in 1879, a book of 140 pages, containing fifty illustrations, twenty-seven of which are on shoes of different pattern and form. Mr. G. W. Bowler, V. S., writes the introduction, and has 'carefully corrected the anatomical parts of the work.'

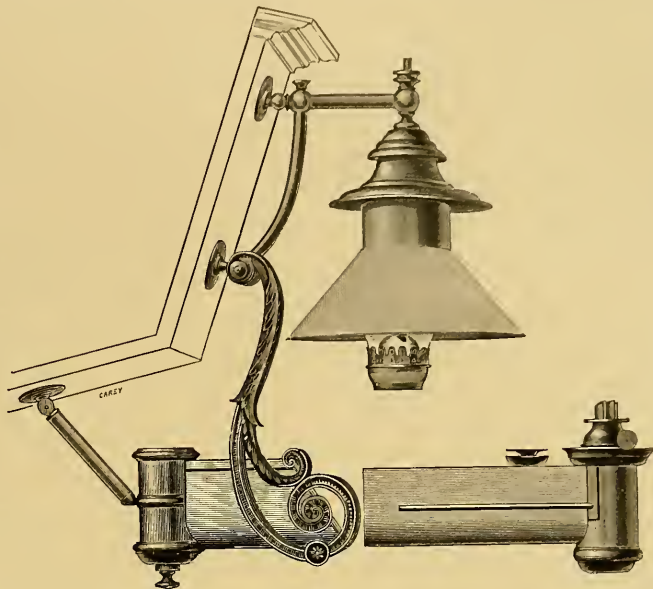

FIG. 2.

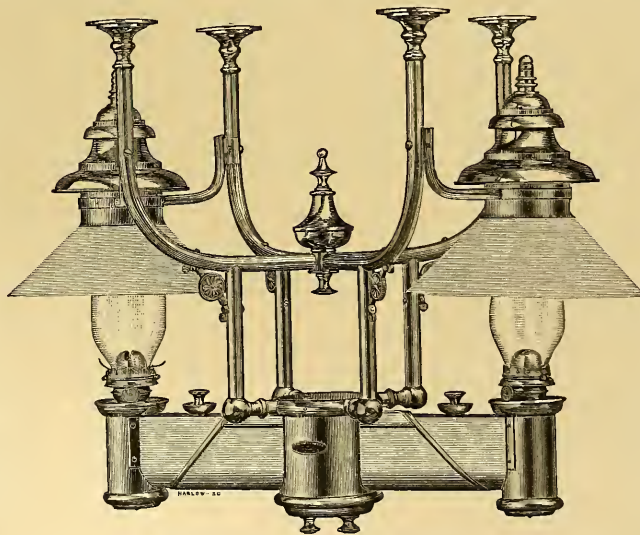

FIG. 3.

A man that has invented more than a score of shoes of different principles and shape, must have been of an inquiring turn of mind; but the fact that so many different kinds were thought necessary, seems to argue against the necessity of any of them. A great deal ought to be expected from

a 'scooped rolling-motion shoe,' if there be anything in a name—which is to be doubted in this case at least.'

Free-Lance becomes more serious where he observes that "this book, however, coming, as it does, from a farrier of forty years' experience, contains noteworthy remarks. Great stress is laid on the importance of paring the crust only, leaving the frog and sole to exfoliate of their own accord, and also taking the greatest care to pare down the crust perfectly level on all sides, so that the foot may stand quite upright. 'If we wish to examine a perfect foot, such as Nature made it, it is generally necessary to find one that has never been shod'; for the common mode of shoeing is so frequently destructive, that we seldom meet with a horse whose feet have not lost, in some degree, their original form, and this deviation from their natural shape is generally proportioned to the length of time they have worn shoes. From this circumstance, writers on farriery have been led to form various opinions respecting the most desirable form of a horse's foot; but had an ever provident Nature been consulted, this variety of opinion, it seems to me, would never have existed."

At that point *Free-Lance* opens a new paragraph, and lets out a flood of his keen sarcasm, saying, "It is strange that Mr. Russell, after expressing himself thus, should have come to the conclusion that more than a score of different patterns and principles were necessary to help Nature. The fact is, that these various kinds of shoes are only so many orthopedic instruments which he considers useful for 'cripples.' So all his inventive powers have been thrown away when 'four inches of iron curled round the toe' are found to answer better than all his far-fetched inventions. On the other hand, it is refreshing to find him speak thus: 'The practice of hot fitting and clipping,—that is, raising a clip on the toe, and sometimes also on both quarters—'is very destructive. Burning the sole will, in time, partially destroy the sensitive laminae, and impair the membranous lining underneath the coffin bone, as well as close the pores of the horn, causing the hoof to become hard, dry and brittle. It also impedes, as a necessary consequence, the healthy growth of the hoof.'"

Speaking of a certain American company, who "refer in their prospectus, to tramway and other companies in the chief towns in England as to their success in working horses with a cold-fitted shoe," *Free-Lance* quotes the following statement of a contemporary: "We hear that a new horse-shoe has been adopted by the North Metropolitan Tramways Company since they commenced to keep their own horses. The stud of the company numbers over 2,000 animals; and, with the view of easing the laborious traveling of the horses over stony roads, the new patent horse-shoe of Mr. —, of the United States, has been tried. This shoe weighs $1\frac{1}{4}$ lbs., or less than half the usual weight. (The Chartist three-quarter shoe weighs five ounces.) 'It is fastened on when cold, and, being without "clips" or calks, the frog is allowed to rest firmly on the ground. The cost of shoeing under the new system is ninepence (18 cents), instead of one shilling [nearly 25 cents], a week per horse.' It is not to be lost sight of that nearly a score of tramway companies employ thousands of horses each; and yet leading authorities have pronounced opinions utterly at variance with each other on the use of the shoe. But doctors always have differed. The statement that fifty cold-fitted shoes are lost to every hot one, certainly could not be substantiated; they stand at no disadvantage at all in this respect; the nails hold better in horn than has not been rendered brittle by scorching. The tramways have now [1886] been using them for nearly two years, and that looks as if they kept in their places pretty well. In Spain, where cold shoeing is universal, and forges very wide apart, shoes keep on until they wear out."

That was written, it may be observed, some six years ago. And, as far as we are enabled to consult "literary shoeing smiths," the cold system has become more popular since. But there are various methods of cold shoeing, and a thoroughly satisfactory system has not yet been discovered, although the Goodenough may be the best. As we intimated at the onset, street railway companies, employing large numbers of horses, are still experimenting and anxious-

ly hoping that a horse-shoe really good enough may soon be invented. And we invite further information from practical (or theoretical) horse-shoers. The literary shoer, from whom we have so freely quoted, writing six years ago, says, "Cold fitting by no means entails any necessity for 'fitting the foot to the shoe.' The shoe, whilst hot, is forged to the correct size and shape of the foot. The pairing of the crust to fit the flat surface of the cold iron takes longer than burning it down with a hot shoe, and the paring of the surface on the bottom is the only 'fitting the foot to the shoe' that has to be done when the latter is of the correct pattern. When it is not, hot and cold fitting stand just equal."

In conclusion let us make one other quotation from *Free-Lance*. He says, "Hear Mr. Fearnley upon this subject, and lay what he says to heart: 'There could be no better service rendered to the horse universe than the passing of an Act of Parliament rendering it a misdemeanor for any one shoeing a horse to reduce the thickness of his soles or frog'—he omits to state the evils of cutting out the bars—or to put under his heels or quarters iron exceeding a defined thickness, except under the certificate of a qualified veterinary surgeon, who should, after examining the horse, explain the need for the same. Horses, like every other property, are national property, and a man owning them mediately has no more right to deface them than he has to deface the coin of the realm, which he also owns only mediately. "What is mine is my own" is still the creed, not only of the vulgar, but of those who ought, at least, to know the rudiments of political economy.'"

It may be added that the horse-world looks to the United States for satisfactory improvements in the treatment of horses generally. An English paper, the London *Daily Telegraph*, says that "there is no nation upon the face of the earth which surpasses the inhabitants of the United States in their tenderness and consideration for horses. Throughout the length and breadth of the Union no such thing as a blinker or a bearing-rein is ever seen, except it be in the equipage of some foolish and fashionable New York lady, who blindly imitates her haughty sister upon this side of the Atlantic, even in the style of her carriage and harness." A report on Horse-Shoeing was presented to the second annual meeting of the American Street Railway Association, wherein it is urged that a horse-shoer "should bear in mind that he is protecting the foot the unnatural wear, * * * therefore, all prejudices as to opinions of how it should be done should be laid aside." And our contemporary, the *American Horse-Shoer*, observes that a fine horse is "a thing of beauty and a joy" while it is in good health and vigorous; and proceeds to urge the necessity of treating the horse with the greatest care possible. Such is the general American sentiment towards this intelligent animal. And, from some of those in this country who are endeavoring to solve the horse-shoeing problem, the theory comes that it is necessary to arrange a shoe that must be taken off when the horse is not at work, just as a biped takes off his boots when he goes to bed.

A Chinese Inclined Tramway.

Two long ropes for a tramway which is in course of construction at Hong Kong, China, are being made by Messrs. D. H. & G. Haggie, Wearmouth Rope Works, Sunderland, England. The incline where the ropes have to work is 4,800 feet long, laid with 35 pound steel rails on steel sleepers, the line being partly single and partly double; the gradients varying between 1 in 2 and 1 in 10, following closely the natural contour of the ground. The total height the carriages have to be raised is 1,300 feet. The ropes run on separate sets of friction rollers, the one a working rope and the other a safety rope. The carriages are attached to each end of the ropes, and as one pair of carriages ascends the incline, the other pair descends. Each car is to contain sixty passengers, the maximum load being seven and a half tons at each end of the ropes. The working rope is passed over a pair of drums eight feet in diameter, and the safety rope over one drum, the drums are driven by two compound steam engines, forty nominal horse power each. The speed of the cars is to be six miles an hour.

Pointers.

ALABAMA.

New Orleans.

Twenty-eight carloads of rails were shipped to Attala via the Northeastern Railway Oct. 20. The rails were those purchased by Mr. Carlisle for the Gadsden Railroad, in Alabama, and formed a portion of the World's Exposition Railroad.

**

CALIFORNIA.

Los Angeles.

Cars have arrived, and the electric railroad in Los Angeles will soon commence running.

**

ILLINOIS.

Chicago.

At a recent Board meeting of the Hyde Park Village Trustees, considerable time was taken up in a discussion of the proposed franchise of the Chicago City Railway Company on Cottage Grove avenue. The company now has a right of way on the avenue between Thirty-ninth and Fifty-fifth streets, and on Fifty-fifth street to Lake avenue, and operates a dummy line. In order to head off the Chicago & Hyde Park Railway Company and other railroad companies, actual and projected, which are endeavoring to get a right of way through the territory in question, the company proposes to remove the dummy line, which is more of a nuisance than a benefit, and lay down a cable on the route mentioned. It also petitions for a right of way on Cottage Grove avenue as far south as Sixty-seventh street. The company has succeeded in gaining the support of the property owners on the avenue between Fifty-first and Thirty-ninth streets, who have always bitterly opposed the granting of a right of way to a steam railroad. The property owners have been firm in their demands upon the company for favorable provisions in the ordinance, and on the following day an amended ordinance was presented in lieu of the ordinance hitherto before the board. It was supplemented by a set of resolutions in its favor, passed September 13, by a meeting of property owners on the avenue in which the amended ordinance was indorsed and the board petitioned to grant the franchise. The ordinance is amended in three particulars. Instead of twenty years the franchise is to run seventeen years. In the original ordinance the company agrees to lay the cable within eighteen months on the avenue and on Fifty-fifth streets, and to lay the cable to Sixty-seventh street within eighteen months after the avenue is severed between Fifty-fifth and Sixty-seventh streets. In the new ordinance it agrees to lay the cable on the south end of the avenue within eighteen months after drainage is provided sufficient to drain the cable channels. The rates of fare are also somewhat reduced, and commutation rates made more reasonable. Messrs. George W. Waite, E. S. Jenison and T. L. Patterson addressed the board in favor of the ordinance. A. B. McChesney, who owns a large amount of property on the avenue south of Fifty-ninth street, addressed the board on behalf of himself and others, remonstrating against the ordinance. The men in favor of it, he said, were all residents at the north end of the avenue. The property owners at the south end were opposed to the granting of the franchise for the reason that the company was getting much for nothing. A general system of drainage might be adopted for that part of the town, and in that case, if the avenue were not severed, the company would not lay the southern end of the cable until it got ready. The property south of Fifty-fifth street could, therefore, get no benefit from the cable for years to come. He knew that men of capital were preparing to buy a right of way just off the avenue and build a line to Kensington, which would be just what was needed by the territory, and he wanted the board to go slow.

A remonstrance signed by men representing 16,000 feet on the avenue was presented against the granting of the proposed right of way to the Chicago & Hyde Park Railroad Company.

Freeport.

On October 20, the Secretary of State issued a license of incorporation to the Freeport Street Railway Company; capital stock, \$45,000; incorporators, Jacob Krohn, J. B. Taylor, F. C. Platt, Walter G. Barnes and George D. Clinger.

**

IOWA.

Lyons.

The city council, Lyons, have a project on foot to erect a new street railway.

**

KENTUCKY.

Louisville.

The belt road connecting the Short-route and the Kentucky and Indiana bridge will shortly be completed. The ballast below the old bridge and the K. and I. is all down, and the trestle east of the Fourteenth street is completed. The iron girders across the cut at the southern end of the old bridge have been placed in position. There are to be stations at Preston, First, Fourth, Seventh, Twelfth, Eighteenth, Twenty-sixth and Twenty-ninth streets.

A petition was received by the City Council, October 7, from the citizens living on and about Fifth and Oak streets, asking that the Central Passenger Railway Company be required to take up its tracks on Oak street, west of Fourth, as no right of way had ever been granted there; and, further, that no right of way be ever granted there. The petition was referred to the Joint Committee on Railways.

**

MASSACHUSETTS.

Boston.

The Metropolitan Railroad Company ran the first car over its new East Boston branch on October 1.

A cable road to connect Cambridge with Boston was long ago talked of, and this method was especially urged when there was considerable agitation in Cambridge in regard to her poor railroad facilities. The talk, however, died out when the Charles River street railway was built, but was renewed about eight months ago when Mr. Charles E. Raymond, president of the Charles River road, visited Cincinnati, Chicago and San Francisco, the supposition being that it was his purpose to examine the method of cable roads in those cities and see if such a road could be introduced in Cambridge. Nothing was done about it, however, and the subject was again dropped, although Mr. Raymond intimated to a number of friends that he thought a cable road could be very successfully operated in Cambridge and Somerville to connect the two cities with Boston and with each other. The purpose to build a cable road is now renewed. We learn that Mr. Preston Cummings, president of the Cambridge railroad, with two of the directors, have proceeded to Cincinnati and Chicago, where they intend to examine the method of operation and style of construction used in the cable roads of those cities. Another fact that gives credence to the many rumors afloat was the appearance at Boston of Mr. Henry Root, the celebrated engineer of the cable road in San Francisco, and the author of the plans used in the construction of the cable road in Chicago. He proposes to have a talk with the presidents of some of the horse railroads in Boston and vicinity, and to take a look around to see if the natural advantages of the city and its suburbs will warrant the successful construction of a cable road. The people of Cambridge have for a long time been dissatisfied with their railway facilities on account of the time which it is necessary to take to reach Boston, and any improvement tending to increase the speed of the cars will be received with great satisfaction. "It certainly appears that Cambridge is to have the long-coveted cable road, and within a short time," says the *Boston Herald*.

Since the beginning of September, two new through lines of cars of the Boston Consolidated Street Railway Company have been running between Charlestown and Roxbury. The Highland cars that formerly ran from Grove Hall to Temple place now run through to Charlestown Neck, and the Middlesex cars which formerly ran from Charlestown Neck to Temple place

now run to Grove Hall. The Consolidated road petitioned the aldermen for a single track through Portland street, from Hanover to Market and through Market to Canal streets, with suitable connecting curves with other tracks, so that the Highland line depot cars may make a circuit by the Boston & Maine, Eastern and Boston & Lowell railroad stations. A movement is making in South Boston to induce the Metropolitan railroad to extend its facilities to that section of the city and thus give Roxbury people a chance to get to the park at City Point, and the South Boston people a chance to reach Franklin Park without paying two fares.

A number of meetings have been held at the West Newton City Hall, agitating for a street railway in Newton, which seems now in a fair way of becoming an accomplished fact. This enterprise is a line in a circuit which plans to use electricity, and become an extension of the present Brookline horse railway. It will run through Beacon street by the reservoir over Chestnut Hill through Centre street, from Newton Centre to Newton Corner, and there connect with the present Watertown and Cambridge horse cars. The plans contemplate branch lines that will also connect with the Jamaica Plain street cars and open up the stretch of country cornered in where Brookline, West Roxbury and Newton join. There has been a strong remonstrance from the Newton Centre people, who object to being sandwiched in between the crowds who each Sabbath flock from all parts of Boston and vicinity to the extensive Catholic cemetery near Chestnut Hill. Those wanting to extend Beacon street and Massachusetts avenue from the Back Day parks, subsequently set forth to Newton the advantages they offer.

There is a general impression that an elevated railroad is an absolute necessity to accommodate the heavy down town and up town traffic during the morning and evening business hours. The street railways are quite unable to afford efficient accommodation.

The board of railway commissioners went to Cambridge on recently to witness the operation of a model of the proposed Meigs elevated railway. The test was made with full-sized cars over 1,300 feet of road built with sharp horse-shoe curves and heavy grades. The trial proved satisfactory, and was pronounced by the president of the board to be wonderful. One mile of track will be built and operated in Cambridge, and then a franchise will be sought to introduce the system in Boston. The system is a unique one. Only a single rail is used. If it proves a success on a larger scale it is expected to revolutionize railroading.

The harbor and land commissioners have had under consideration the following petitions: Of the city of Boston, for license to build a wharf on the easterly side of Long Island; of the Boston & Lowell railroad, for license to widen the passenger railroad bridge across Charles river, to build other pile structures, and to fill in solid its docks in the river in Boston and Cambridge.

Springfield.

The Springfield Street Railway Company has received four new cars from the Jones Car Manufacturing Co., Troy, N. Y. They are fourteen feet long.

The West Springfield Street Railroad has been under consideration by the aldermen. They have adopted reports specifying the style of track and paving for streets and on the bridge. One report provides for "strap rails," not more than 2 inches wide nor $\frac{5}{8}$ inch thick, the planking to be chamfered to admit the wheel flanges. The other report provides for a steel grooved rail like that in the East Providence, R. I., bridge.

Woburn.

The North Woburn Street Railroad has been completed. It runs from North Woburn through the business part of Woburn to the Boston & Lowell R. R., with an extension thence to Winchester. The original road was built in 1867, but was not well managed. The road has had an appreciable effect on real estate, and next season there will be considerable building along the line. The track round the Common will be commenced forthwith.

MICHIGAN.

Ann Arbor.

The Ann Arbor Street Railway Company has been incorporated. Capital stock, \$25,000; Zena P. King, J. E. Beal and L. D. Taylor incorporators.

Detroit.

The convention of electric light people at Detroit, which spanned the breach between summer and autumn, was a rare opportunity for the discussion of two or three mooted points in the convention, and some outside the sound of the chairman's gavel, in the open air, concerning which the *Electrician* has the following "pretty tale":

Everything at Detroit was pleasant, profitable and gratifying. The papers were all of a class at once dignified yet unsifted, and showed the writers had well digested their subjects. Several of the delegates took part of a day off, and visited the two electrical railways. By a misunderstanding, in an attempt to reach the Van Depoele railway the party went north, and came upon the unfinished road of the Detroit Electrical Works Company. This being in no condition to furnish transportation for the crowd, steps were retraced to the Russell House, and a new start made to the westward. Mr. Van Depoele had but just got the road into operation, and was running at regular intervals, over a track one and one quarter miles, with perfectly satisfactory results. The time made varied from four to four and a half minutes over the route. The train consisted of one ordinary horse car, and the motor car, which had been made from a car similar to the first. There was no lack of passengers, and no end of boys who tried to catch on. One trip was made in a much longer time than the average. Some ten or fifteen cows were on their way up to town to be milked and spend the night, and they could not understand how a car could run without a horse. Either the cows or passengers came near being badly "collided." Just before we found out which it would be, Charley Van Depoele shut off the current, and stopped the sudden tide of emigration from the motor into the passenger car. We lost time, but we saved—well, the cows or the folks, and as before remarked, we never will know which.

.

MISSOURI.

Kansas City.

Trains commenced running over the surface portion of the Kansas City Elevated Railway, October 10.

.

NEW JERSEY.

Orange.

The meeting-room of the Orange Common Council was crowded on the evening of Oct. 4 by a large assemblage of citizens who had gathered to hear the decision to be given by the Board in the matter of granting a franchise to the new electric railroad to lay their tracks on several streets. The amendment to the Horse-Car ordinance permitting the Orange Crosstown and Orange Valley Street Railway Company to run their cars by electricity and relieving them of the obligation to pave between the rails came up on its second reading.

After considerable argument, participated in by aldermen Snyder, Epply, Barker and Garrett, the whole matter was stood over.

.

NEW YORK.

Albany.

The Albany Street Railroad Company has removed the Hamilton street and Madison avenue cars and horses from the South Pearl street stable to the new and commodious quarters on Quail street.

Long Island City.

A new corporation, to be known as the Riker Avenue and Sandford's Point Railway Company, has been incorporated with a capital of \$20,000. The proposed route begins at Riker av, Long Island City, at the intersection of the Canal between Kapelyca and Blackwell sts., and thence runs along Riker av, to the south line of Long Island City, thence south, near the shore of the sound, to a point near Bowery Bay,

thence east along Bowery Bay to Sandford's Point, and thence south-east to Flushing Bay; distance about two miles. The incorporators are William Steinway, George A. Steinway, Emil Rothgeber, Felix Kraemer, Oscar R. Steins, James H. Hempstead and Charles Froitzsch.

New York.

We are credibly informed that the average daily gain in the earnings of the Manhattan road for the first two days of the 5 cent fare on the Third avenue line, was \$3,333 over last year, and on Saturday (the second day) the system carried over 405,000 passengers. On Sunday the company's earnings increased \$5,700, or fully 25 per cent.

A New York dispatch of Oct. 9 also says: The reduction of fare on the Third Avenue Elevated line to 5 cents for all hours has been so satisfactory that it is proposed to reduce the fares on the Sixth avenue line to a uniform basis. Mr. Field says that, if necessary, he will fight the rest of the board until he gets this motion adopted. He is enthusiastic over 5-cent fares. Since Oct. 1, when the Third avenue reduction was made, the receipts of the Manhattan company have increased over last year an average of more than \$3,000 per day.

On the other hand, it is asserted that "the 5-cent fares at all hours on the Third Avenue Elevated road, has evidently not proved a conspicuous success. Col. F. K. Hain, the general manager of the elevated railways, was not as enthusiastic over this change as he has been over others which he has put in operation and refused to give any figures for comparison with receipts when 10-cent fares were in vogue. He says that he will be better able to judge of the success of the scheme later on. 'More people and less money,' said the ticket agent at the City Hall station, when asked as to the effect of the reduction. 'Less money and more people,' was the response of the down track agent at Sixty-seventh street to the same question. The cars were certainly better filled during the middle of the day, but the whole number transported was not sufficiently large, says an eye witness, to bring the daily receipts up to those prior to Oct. 1. 'There was some little diminution in the travel on our road yesterday and today,' said the secretary of the Third Avenue surface road when questioned; 'but not enough to cause any alarm. You may state positively that this company will not reduce fares to 3 cents, as has been reported, since at that rate each passenger would be carried at a loss. It costs us now about 3 3/4 cents to carry each passenger. If anything is done it is probable that the number of cars run during the middle of the day will be lessened.'"

At the Second Avenue surface road office it was said that there had been no perceptible difference in the travel on that road since Oct. 1.

Aldermen Cleary, Cowle and Lang, of the Railroad Committee of the Board of Aldermen, at a recent meeting, listened to arguments for and against the application to construct and operate a horse railway along St. Nicholas avenue to the Harlem River, and through various cross-town roads. Counsellor J. A. Beal was the mouthpiece of the opposition, which represented the Goelet and other large estates. Their main objection was that a railroad would destroy one of the finest drives in the city. Mr. Luke Cozans was the advocate of the proposed road. The road, he said, was a public necessity and would, when built, be a great public benefit.

Application was also made to the committee to build a new road, with branches, in Westchester. It comes from the Melrose and West Morrisania Railroad Company. There was no opposition.

The New York District Railway Company, which was organized last December to build a four track electric railroad under Broadway, is preparing plans for an extension of its tracks from the Brooklyn Bridge to the Grand Central Station. The District Railway Company has already one branch—the Fourteenth and Twenty-third Street District Railway Company—organized to operate cross-town railroads under the streets named, and a second branch will be formed to operate the new road.

The route of this new road, which has not yet been named, will be from a place near the Brooklyn Bridge, to Elm street and Leonard, running underneath the buildings, crossing Elm and keeping to the west of it to Marion street. There it will run under the street instead of under the houses to the head of the street, then beneath the block to Great Jones, up Lafayette place, under Poole's Theater and a corner of Denning's buildings, and thence up below Fourth avenue to the Grand Central Station. The plans are not yet finished, but as soon as they are completed the company will be organized and a charter applied for.

The New York Arcade R.R. is meeting with much opposition, and a number of property owners have appointed a committee to protect their interests. The committee will begin action to obtain injunctions, and will endeavor to have the company dissolved. They claim that if constructed on the adopted plans it will necessitate the rebuilding of the foundations of a number of large buildings. The officers of the company still insist on pushing their preparations, and will go right ahead.

A New York dispatch of Oct. 6 says: The New York District Railway Company, having been unsuccessful in getting the required number of consents of the property owners to its proposed railway under Broadway and Madison avenue to the Harlem river, has applied to the general term of the Supreme Court for the appointment of three commissioners to take testimony and report as to whether the railway should be constructed. The court, upon the application of Grosvenor Lowrey, has ordered that all property owners and persons interested should show cause, by the 15th inst., why the application should not be granted.

The people of Harlem are impatiently awaiting the completion of the cable road through 125th street, from the East River to Manhattan street, and thence to the North River, with a branch running along Tenth avenue to Fort George, above 11th Bridge, a total distance of about eight miles. The Tenth avenue extension since it was finished, has been in successful operation. On 125th street the road is now virtually completed from the East River to Eighth avenue, a little work only remaining to be done near Sixth and Seventh avenues. Between Tenth avenue and the North River there is a large force of men working, and it is expected that the entire roadbed will be completed forthwith. The work of putting in the pulleys and adjusting the cable will then begin, and it is probable that the road will be in full operation by the Christmas holidays.

The New York Cable Railway Construction Company has been incorporated by Charles S. Beardsley, Charles D. Ingersoll, D. Frank Lloyd, Henry L. Storke, William C. Reddy, G. Crighton Webb, Cornelius V. Sidell, Edmund Beardsley and John F. Shelley. The capital stock is \$200,000, and the objects are to construct, operate, manufacture, sell and lease rolling stock and machinery to be used on railways, and especially those operated by cable and stationary engines.

A large electro-motive engine (the largest yet made, as far as we know) has been constructed by Bentley & Knight, of Rhode Island, for the Underground Railway of New York. Two electro-motors coupled together give a joint power of 500,000 watts—equal to 670 horsepower. All the ordinary electrical appliances are employed on this engine, working automatically. The convenience of electricity for underground railways will now be demonstrated.

Experiments with electric motors are about to be renewed on the Ninth Avenue Elevated Road, where they were conducted last spring. During the summer Mr. Daft has been superintending the construction of a larger motor than the one that was then used. It will be the largest electric motor of this kind that has yet been built, and will represent about 125 horse power. The one used in the spring could exert about sixty horse power, and it weighed nine tons. Mr. Mitchell, president of the Safety Electric Railway and Power Co., says the experiments with it were entirely satisfactory, as showing the practical working of the motor, but it was not sufficiently powerful. It could pull

two cars as easily as any steam motor, but more than that weighed it down. It is expected that the new motor will draw four or five cars as readily as the present engines do. The motor will be placed in the cab Benjamin Franklin, and a series of experiments will begin at once.

The Board of Aldermen has come to the conclusion that the car drivers should receive back the amounts paid by them for licenses under the unconstitutional ordinance passed by the Aldermen over the Mayor's veto. The Board passed a resolution recently requesting the Board of Estimate and Apportionment to appropriate a sufficient sum to make the repayment.

Senator Evarts was in town on Oct. 7 and held an interview with Charles P. Shaw, Esq. relative to the appeal of the Cable Company, which came before the Court of Appeals on October 20.

The Arcade Railway controversy was up for a hearing recently in Supreme Court Chambers before Judge Andrews, in the shape of a motion, made on behalf of the railway company, to strike out certain parts of the complaint of John Jacob Astor and others, who have brought suit to restrain the building of the Arcade Railway, as being irrelevant, redundant, and having nothing to do with the cause of action, and also to make more definite certain parts of the complaint which were alleged to be vague, contradictory, and without sense. Robert Sewell, ex-Chief Justice Charles P. Daly, and Senator Thomas were present in support of the motion, which was opposed by ex-Judge John F. Dillon, Joseph Auerbach, Albon P. and William Man. The project, as alleged, will involve a loss to the city of \$1,000,000 per annum, because property on Broadway will be irreparably damaged by the passing trains, buildings will be made insecure while the road is being constructed, and access to them be interfered with, the streets will be made impassable, and great damage will accrue in changing the water, gas, and other pipes.

Mr. Sewell stated that the railway company was anxious to have an early hearing, in order that the question might be passed upon, so that it could defend the suit upon the ground that the legislation which permits the building of the road is constitutional in every respect. He urged that although the Legislature has said that the act authorizing the building of the road is for the benefit of the people, although it has said that private rights must be respected, and no damage done without compensation, nevertheless, the plaintiff's theory was that the work must not proceed, as the act is unconstitutional. The sole question at issue is as to the constitutionality of the act. Mr. Sewell declared that the plaintiffs must show some wrong before they can be heard. If, as alleged, the city would sustain a loss of \$1,000,000 per annum if the work was carried on, the city could sue for such damage, and not the plaintiffs. William Man replied by arguing that Mr. Astor and the others have a perfect right to come into court, and bring an action on behalf of themselves and others to test the right under which the railway company proposes to proceed. "We know what the property along Broadway and Madison Avenue is, and how it will be damaged. We are interested parties. We are parties who are peculiarly interested. The Legislature and the Governor certainly ought not to be peculiarly interested." He contended that the allegations in the complaint were proper and could not be made more specific. Ex-Judge Dillon supported the views of his associate. The Court took the papers.

The Union Electric Company recently made a trial of the electric motor on Ridge avenue. The wires are carried in a conduit as in the cable system. The trip was satisfactory. The electric current drives, lights and heats the cars and rings the signal bell.

**

NORTH CAROLINA.

Taylorsville.

This place is to have a new railway. Address R. Z. Linney or E. M. Stevenson.

**

PENNSYLVANIA.

Philadelphia.

The grand jury for the September term, in

their final presentment, call attention to the miserable condition of the streets, both as to paving and cleanliness, and urged that the street railroad companies shall be held to a strict observance of the terms of their charters requiring them to keep in repair the streets occupied by them.

At a meeting of capitalists recently held here, it was proposed to erect a number of elevated railroads in the city, reaching to the suburbs. A company was speedily organized representing \$6,000,000, and the following officers chosen: George H. Boker, president; Frederick B. Esler, vice-president; Ford C. Stevens, secretary and treasurer; George H. Boker, Charles B. Wright, Henry C. Gibson, James A. Wright, Frederick B. Esler, Samuel K. Shipley and Walter Wood, directors. It is proposed by the company to build an elevated double-track road from Jenkintown to Front and Westmoreland streets, thence along Front street to Snyder avenue, at the southern end of the built-up portion of the city. A branch elevated road, double-track, is projected along Emerald street, from Front to Franklin suburb, and thence a double-track road to Tacony. It is said that the entire road, equipped and ready for operation, would cost \$6,000,000. While the meeting was in session, Ford C. Stevens telegraphed from Harrisburg that he had obtained a charter for the Philadelphia and Northeastern Railroad, which is to be the name of the road. An ordinance granting permission to this company to lay its tracks on an elevated road over the route mentioned, was subsequently presented in Select Council and referred to the Railroad Committee. The ordinance states that the company agree to charge five cents for fare between 5 and 8 o'clock in the morning and 5 and 7 in the evening.

**

TENNESSEE.

Knoxville.

The Rutledge Pike Street Car Company will soon begin the construction of the road.

**

TEXAS.

Denison.

The Denison Street Railroad Company contemplate operating its lines by electricity.

**

WISCONSIN.

Appleton.

The Van Depoele Electric Street Railroad was opened recently. The cars were crowded, and the results were highly satisfactory. There are five motor cars, one open and four "bob-tails," which will require no conductors. On the open car the motor is placed on the front platform. The conducting wires are overhead, at the side of the track. Water power is used to generate the power.

Eau Claire.

The Eau Claire Street Railroad Company, operating the line transferred by the old company to A. G. Bradstreet, has been incorporated. Directors, Albin G. Bradstreet and Sydney W. Curtis, of New York City, and Weston Lewis, of Gardiner, Me. Capital stock, \$50,000. The South Barstow street line will be reopened, and several extensions built to the northerly portions of the city. New bob-tail, one-horse cars will be put on, and will run at ten, instead of twenty-minute intervals.

Green Bay.

F. J. Monroe proposes to build a street railroad here if the franchise is given him.

Business Notes,

As an evidence of the superiority of the wire cables manufactured in the United States we note a late sale made by the John A. Roebling's Sons Company, of Trenton, New Jersey, to the Cable Railway Company in Australia. An extensive system of Cable Railways now under construction in that country called for duplicate and triplicate cables to the extent of some sixty miles. With active competition from German and English manufacturers, the contracts were

awarded at a higher price to the American company. The buyers, after careful examination of the records made by the cables of various makers on the cable roads of this country, came to the conclusion that at a higher price, those of the above named company would be the cheapest in the end. The lengths vary from 14,000 to 30,000 feet, and the sizes from 1¼ to 1½ inches in diameter.

The United States Pump and Valve Co., who are manufacturers of straightway valves and gates, and also the Pearson noiseless steam motors for street railroads, have secured headquarters at 28 Oliver Street, Boston. This company is building a large factory at Saugus, which will be completed in a few days.

Those desiring further information concerning the patented improvement in horse collars and harness-saddles, described in another column, should write to, or call upon James T. Miller, 1247 Washington street, Boston, Mass. It is claimed that street railway companies can save a large amount of money annually, and keep their horses in better and more useful condition, by the use of the new pad referred to. For harness-saddles it appears to be an admirable device; and the frequent usage of many proves them to be invaluable.

Sherburne & Co., 53 Oliver Street, Boston, Mass., are the manufacturers of the improved lamps and lamp-holders illustrated on our 316th page; and they will furnish any further information desired, respecting sizes, capacities, and styles of plating.

Among the most prominent street railroad builders in Boston are Payson & Company, 593 Albany, and 354 Blue Hill Ave., Roxbury.

A. Holt & Co., of 38 Beach St., Boston, have a neat car heater, which is said to be effective in giving steady warmth.

Mr. H. M. Glines, of the Glines' Patent Car Brake Company, has working models on exhibition at rooms 7, 8 and 9, 104 Washington street, Boston. The brake is highly spoken of as an improvement on the present street-car brake, being easier to handle and operate, quicker in action, and more effective in efficiency. One of the chief features that deserves attention is that the levers are so connected that the pull upon the brake beam is direct, and in the center, thus avoiding the side thrust so often noticed in the ordinary or old-fashioned brake, and which causes such unevenness in the wear upon wheels and brake shoes, as well as the straining and breaking of brake beams.

W. B. Mack, 70 Federal St., Boston, the well-known inventor of "Mack's Injector," has a fine working model of The Mack Elevated Railway on exhibition at Boston.

Notes.

THE STREET RAILWAY GAZETTE is indebted to the publishers, H. V. & H. W. Poor, 70 Wall street, New York, for a copy of their new work, Poor's Directory of Railway Officials and Railway Directors. The Directory contains lists of officials of every road in the American continents and Great Britain and Ireland, and of street railroads, and of auxiliary organizations. The Directory may be considered an annual supplement to the well known Poor's Manual of the Railroads of the United States. It is a valuable work, neat and compact in compilation, handsome in typographical appearance, handy for reference, and is in every way highly creditable to the publishers.

A CONTRACT for 380,000 feet (5½ miles) of wire rope has been awarded to American manufacturers. The wire rope will be partly for the proposed new cable lines in Melbourne, Australia, where it has been decided to build twenty-six miles of cable road.

J. G. BRILL & CO.,

PHILADELPHIA,

Builders of

Railway and Tramway Cars.

GOLD MEDAL
For Best Closed Car
AT
CHICAGO EXHIBITION
Of 1883.



GOLD MEDAL
For Best Open Car
AT
NEW ORLEANS EXHIBITION
OF 1885.

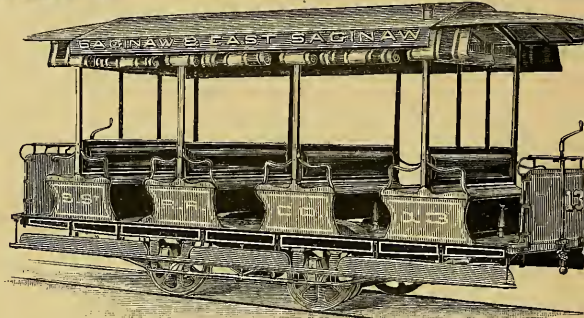
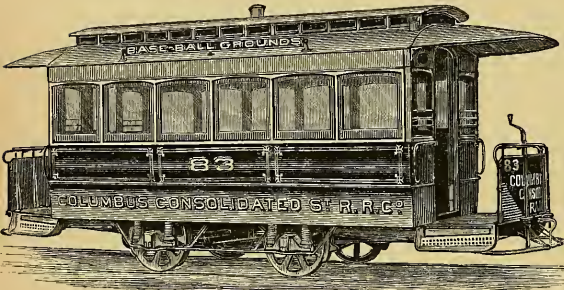
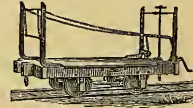

Railway Register Manufacturing Co.

JAMES McCREDIE, *President*, Buffalo, N. Y.

ALARM REGISTERING PUNCH

FOR STEAM AND STREET-RAILWAYS.

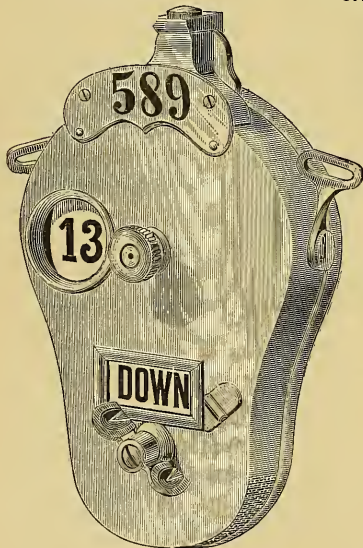

INDICATORS,
ENUMERATORS,
STATIONARY
REGISTERS
And Classifiers
of all kinds for
Registering Fares
on Steam and
Street-Railways.

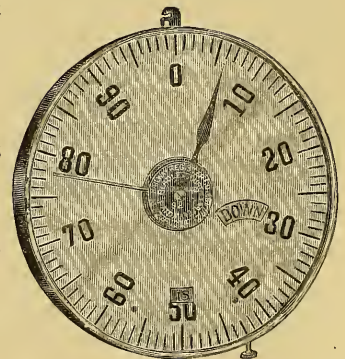

BEADLE & COURTNEY, Gen'l Agents, 1193 BROADWAY, NEW YORK.
Philadelphia Office Removed to 423 WALNUT ST.

The Street Railway Gazette.

VOL. I.

CHICAGO

DECEMBER, 1886.

NEW YORK

NO. 12

D. W. Stroud.

Mr. D. W. Stroud, the newly elected president of the Ohio Tramway Association is of American parentage, and was born in the village of Potter, Yates County, N. Y., in the year 1845; he attended the public schools until he was fifteen years old, when he entered the army as private in the 11th Michigan Infantry, but exchanged about a year later into the 9th Michigan Battery, serving under Generals Hooker and Meade in the Army of the Potomac, and under Sberman in his famous march to the sea. He was present at the battles of Gettysburg, the Rapidan, etc., and, by an honorable adherence to duty, managed not to lose either his head or his commission. At the close of the war, Mr. Stroud went to Cleveland, O., and entered the employ of the Woodland Ave. Street Railway Company, remaining with that company, either as driver, conductor, barn-foreman, or Assistant Superintendent, until, tired of being an employé; he took charge of the Dorr Street line in Toledo, then controlled by T. P. Brown, and, upon completion of the Monroe Street road, it passed under his rule. After remaining there four years, he purchased a quarter interest in the Central Passenger Railway of the same city, and became a director and the manager of the road in 1876. For another four years he stayed there, and then, disposing of his stock at a handsome profit, proceeded to Springfield, Ohio, and organized a company there, and founded and built the system of street railroads that spreads itself all over that city. He is President of the company, and has left nothing undone to popularize the Citizen's Street Railroad of Springfield.

Mr. Stroud is essentially a self-made man, his earnings having constituted his only resources, outside of a keen judgment and remarkable foresight. He is a married man, and the proud possessor of two children, the elder a girl, the younger a boy.

THE Manhattan elevated railways of New York City have a capacity for handling 700,000 passengers a day. Since they were opened, in October, 1872, the roads have carried an aggregate of 693,000,000 passengers, only one of whom was killed; and the total receipts to Oct. 1, 1886, were over \$48,500,000.

Sunday Law vs. Street Cars.

The polite inhabitants of Boston, Mass., were watching the street cars, and the movements of the police, last Sunday (Dec. 5), with a sort of curiosity somewhat akin to the anxiety of old England people, while watching the weather on St. Swithin's day. There was nothing wrong, but there was some under-current of anxiety lest the street cars should stop running. No answer could be elicited from Police Commissioner Whitney the previous day in reference thereto.

On Dec. 1, Judge Colburn, of the Supreme Court, declared that the street cars were trespassing against the law when running on Sunday, and Conductor Day lost his suit for damages because he was thus breaking the law when injured. The report of the Court's decision had been awaited with great interest.

A Boston contemporary observes that "The rigid enforcement of the Sunday law in Boston, a puritanical relic which is quite a revelation to a majority of our citizens, and to those who knew that such a law did exist, but supposed it to be a dead letter, a matter of surprise, is creating quite a sensation here, and causing a large amount of curious comment in all our large cities. It was supposed by those who knew of its existence, that a revival of its enforcement was quite as impossible as the putting in force the 'Blue Laws' of Connecticut. Here in Boston the idea of closing of barber's shops and apothecaries reminded many old citizens of the days when the 'Anti-Bell Ringing Society,' and smoking in the streets

ordinance was enforced, which created a vast amount of ridicule, and brought the city statutes into contempt. It is curious to look back upon the early records of our city, and compare its enactments 250 years ago with those of to-day. The 'Court of Assistants' was formed just after the arrival of Winthrop, and the following instances of its administration of justice (?) are quoted, to be used in comparison with those of to day: June 14, 1631—Philip Radcliff, for censuring the churches and government, has his ears cut off, is whipped and banished.' Oct. 3, 1630—'The court orders that no person shall take any tobacco publicly under a penalty of two shillings sixpence.' Nov. 9, 1630—'It is ordered that John Barker shall be whipped for shooting a fowl on the Sabbath day.'



The Sprague Electric Railway System.

Numerous experiments are being made, from time to time, with electricity in its application to railway propulsion, especially on elevated passenger railways, which now present the result of many years' careful thought in engineering study. The generating station is the first matter to be considered. The system offered by Mr. Sprague is the operation of a number of dynamos wound so as to generate at their normal speed, and with a full load, an electro-motive force of about 670 volts at their terminals; 600 volts being the potential with which a series of experiments have been operated on the Thirty-fourth street section of the Third Avenue Elevated Railway, New York.

Announcement was made some time ago that Mr. F. J. Sprague would make experiments with his system on this road. Car No. 293, which is a full-sized standard elevated passenger car, was placed at his disposal by the officers of the Manhattan Company, which was properly equipped, and it has been a thorough-going experimental car, in which many problems have been and are being worked out.

Mr. Sprague has been engaged for a long time in the elaboration of a system, and he expects ultimately to overcome all difficulties. A paper which he read before the Boston Society of Arts, some time since, was an elaborate

horse-power each) are in use at one and the same time. An efficiency of 80 per cent. for the motors means a current of 43,291 ampères when 100 volts are maintained at the terminals of the motors. The adopted standard of 600 volts reduces this to 7,215 ampères. And the problem to be solved is how to handle this force properly. The difficulty has been very much reduced already. The dynamos used, as at present arranged, are wound for constant potential circuits. They are of very low armature resistance and have high resistance shunt fields.

The dynamos may be built so as to maintain a constant potential under all loads at the junction of the mains with the track. There is one disadvantage, however, about this, as our contemporary, *The Electrical World*, points out, and that is, if the electro-motive force of the dynamos rises automatically, and there should be any very serious cross on the line, the machines might be burned out. Where they are wound with the field magnets in a simple shunt circuit, and no cumulative coil in series with the armature, any very bad cross on a line will lower the potential at the terminals of the machines, and while a very heavy load will come upon them for a brief interval of time, the drop of potential at the terminals will be sufficient to so far demagnetize the field magnets that the machines cannot be burnt out. In addition, however, to the ordinary shunt coil, Mr. Sprague employs a

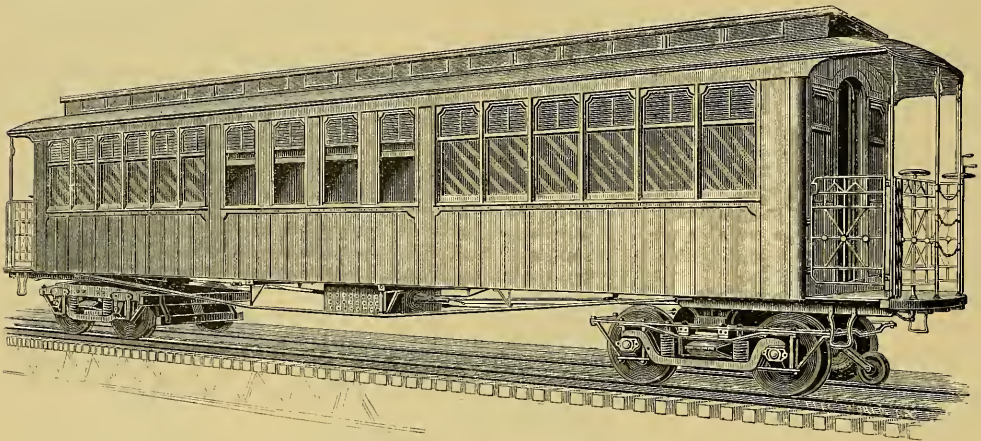

FIG. 1.—SPRAGUE ONE-CAR TRAIN.

technical article dealing with the application of electricity to propel the motors on the New York elevated railways. And when the Sprague, or any other system, may be sufficiently perfected it will be a great and gratifying improvement in railway traveling to get rid of the sparks, smoke and dirt continually emitted by the locomotive engines, whereby the seats are covered constantly and the eyes and faces of the passengers are endangered in no small degree. It is expected that the Sprague system will soon be sufficiently matured to enable the Manhattan Company to give all their locomotives a long leave of absence and let their numerous trains run by electricity.

On the New York Third avenue elevated road, for instance, the power of propulsion is expended in three different ways. (1.) Over one-half—59 per cent.—thereof is exhausted in overcoming the inertia of the train; (2.) about one-quarter—24 per cent.—is used in lifting the cars along up grades; and (3.) 17 per cent. is expended in traction. The engines on the railway under notice have a capacity of about 185 horse-power each, and the aggregate force necessary for the entire trip of $8\frac{1}{2}$ miles, including stoppages, is that of about 74 horses for each train of four cars. And the whole power exerted at one time, for all the cars in motion, is that of about 4,640 horses; or, to speak more correctly, and bearing in mind that there is a difference between the power of a horse and the technical or scientific horse-power, twenty-five engines (of about 185

special winding, one which now appears in his railroad motors. This special winding is a coil in series with the armature, whose polarity is exactly at right angles to the polarity set up by the shunt coils, and is so proportioned that it automatically maintains the point of non-sparking coincident with the line of contact with the brushes on the commutators. This series coil has not the effect of an ordinary cumulative coil. It does not raise the potential of the dynamos, but simply makes them non-sparking with fixed brushes under all loads.

Another conclusion arrived at is that it would be advantageous to have two central stations rather than one. By having two stations, each removed about a quarter of the distance of the length of the road from either end, the size of conductor which is necessary for the middle rail is only one-fourth that which would be required were there only one station in the middle. Furthermore, the points of supply of current from each station should be maintained at the same differences of potential, to obtain which Mr. Sprague runs an independent line wire from station to station, with suitable indicators in it, showing whenever there is any inequality of potential existing at the supply points. This is done because the highest possible economy requires perfectly equal differences of potential at all points of supply, no matter how many the trains, nor where they may be situated on the track. The combined capacity of the two stations would be something more than equal to the

highest total horse-power appearing at any one time on the road.

With regard to the question of distribution, it is pointed out that the main rails are grounded and form one side of the circuit, being connected to the structure of the road at suitable intervals. Four single rails, together with the superstructure and the ground connections, form a path of very low resistance, and there would probably be no need of any reinforcement at the fish-plates. Should such reinforcement be found to be advisable, a short connecting piece would be made from one rail to another, very much in the same manner as is now done where the track is used for electric signals, or, as with the middle rail, a main conductor would be used. The other part of the circuit consists of a very light rail of special construction, thoroughly well insulated in a simple manner, and raised so that its top is from three to four inches above the plane of the ordinary traffic rails. The main conductor, thoroughly insulated, is connected to both ends of each section by fusible plugs or cut-outs and a short branch circuit. The branch circuits of the cut-outs form a Y connection, the main conductor being secured to the stem of the Y and one end of each section to the arms of the Y. It will be seen now that in the normal condition of affairs if current is flowing from one part of the road to another part, and there is no train between these two parts, that this current is carried over a double ladder-

does occur, sufficient to break the safety catches of that particular section, a signal is set and cannot be replaced until the section is repaired. And, besides all that, the conductors of like potentials on different tracks and switches are connected by cross circuits, which tend to equalize the potentials on the line, especially where there are any bad joints in the rail, and also when one track is more heavily loaded than the other. Another great advantage of these cross connections is that the current generated by trains running on down grades and stopping, can not only be sent back to the conductor on its own particular track and circulate through the system, but it can take a shorter and more direct path to the opposite track where a train may be moving on the up grade, or just starting. It should be further stated that both tracks are supplied from the same source, forming one complete circulating system. All motors are run in parallel circuit with each other, the current in each being independent of the current in all others, and the motors on the one track are in parallel circuit with the motors on the other.

Touching the question of motor construction, and contrasting the same with the ponderous and puffing locomotive steam engine (which shakes an elevated road most dreadfully), the advantages of electricity become very striking. The locomotives now in use aggregate a weight of about 22½ tons. Of this weight only fifteen tons is available for

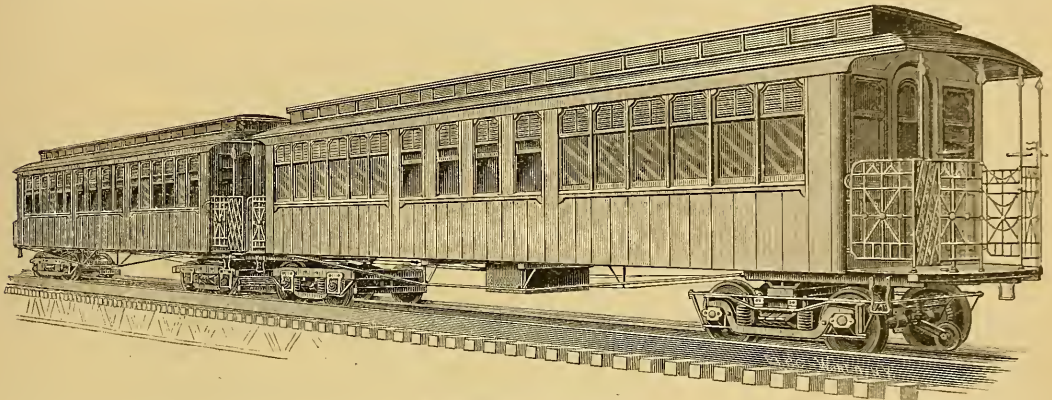

FIG. 2.—SPRAGUE TWO-CAR TRAIN.

like circuit. The main conductor carries the major part of the current and the sectional working conductors a smaller part. So long as there is no train on the sections adjacent to any connection, it is evident that there is no difference of potential existing at the two opposite ends of the connecting branch, and no current will flow over it, although very powerful currents are flowing past each end of it. These currents will, of course, be in the same direction. When, however, a train enters a section it does not make any contact whatever with the main continuous conductors, but only with the working conductor, and current is supplied to this working conductor from both ends, partially, it may be, through the working conductors next adjacent, but mainly through the branches connecting it to the main conductor; that is, there is a difference of potential set up in the different parts of this circuit, and parts which were inert before become active the moment a train passes on to a section, no matter whether the train be taking current from the line or giving it to it. The current that flows through these branches may be made to actuate any kind of special device which is necessary, and thus forms a perfect block system of signaling.

Such a system of main and working conductors afford an opportunity to cut out any section of the line on which an accident might occur. The rest of the road will not be interfered with, and the whole circuit will remain intact except the particular portion effected. And the signals, too, may be of such an automatic character that when a cross

traction, this being the weight on the drivers. There are dangerous strains, which cannot be avoided while steam engines are in use, especially on the elevated roads. And, furthermore, the vibration set up by a moving train, both vertical, due to the weight, and longitudinal, due to the motion of the train, has a shattering effect which is very great. It tends to loosen the bolts, and badly strains the whole structure. There is an additional vibration due to the reciprocal strokes of the steam locomotive and its consequent unevenness of pull. If an electric locomotive were applied to handle a train, and it was made of 15 tons weight, it would pull more than a steam locomotive of equal weight, since all of it could be put upon the driving wheels, and there would be no necessity of additional truck wheels. But a fifteen-ton electric locomotive properly constructed and handled, would pull even more than a twenty-two and a half ton steam locomotive with fifteen tons on its drivers. If the weight was distributed on four wheels, the wheels being on two perfectly independent axles, there would be absolutely equal pressure on each. This, however, is not the case with a steam locomotive. In addition to this, the strain could be simultaneously brought on all the wheels of an electric locomotive with such a perfect progression that they would adhere to the rail more firmly than an equal weight where the motion is derived from a reciprocal movement. Furthermore, there is a certain amount of increased adhesion of the wheels, just how much it is impossible to say, because it varies under different conditions, and this is

probably due to the heating effect of the current passing from the rail into the wheel.

Mr. Sprague has made considerable advance in this respect, namely, placing the motors underneath the cars and on the trucks which carry them. In this way at least one-half of the weight of the car and the passengers, as well as the motors, is available for traction. By thus placing the motors under the cars, each is made an independent unit, or a dozen cars can be operated in a single train by a small regulating truck placed ahead of them. This is the manner in which a single car is now being operated on the Thirty-fourth street branch of the Third Avenue Elevated Railroad in New York City.

Figs. 1, 2 and 3 of the accompanying illustrations show the car in one and two unit combination, and in end view, as it appears upon the track. The truck upon which the car is mounted is shown in perspective in Fig. 5, and in detail, plan and elevation in Figs. 4 and 6. For these cuts we are indebted to *The Electrical World*. Our contemporary published Mr. F. J. Sprague's paper, which was read before the Boston Society of Arts, and in its last issue for September a full account appeared of the progress made with the Sprague system. And we have much pleasure in placing a full account thereof specially before our clientage, which comprises the principal street railway men (surface, elevated and underground) throughout the United States and Canada particularly, and throughout the world in general. And we hope that steam may soon be superseded by electricity as a locomotive force.

Each of the two motors carried on the truck, in the illustration, is in the space between the axle and the center cross-piece. The field magnets, which are made of the finest selected scrap wrought iron, are built up of four segments, all forming parts of circles. Two of these form the pole-pieces, and to these are attached heavy bronze hangers. The latter carry the armature, which is wound on a special modification of the Siemens system, and has at each end

These differ in character. One is keyed and bolted directly on to the axle, which is first turned off, and is a fixture. The other is composed of four parts, two being inner webs which are keyed on to the axle; the two outer ones form the geared section and are bolted together and have corresponding webs projecting inwardly, and fit snugly both on the outer edge and on the face of the webs which are keyed to the axle. The outer and inner webs are held together partially by the method in which they are turned up, but principally by bolts passing through them which work in curved slots. These, then, constitute adjustable split gears, and are probably.

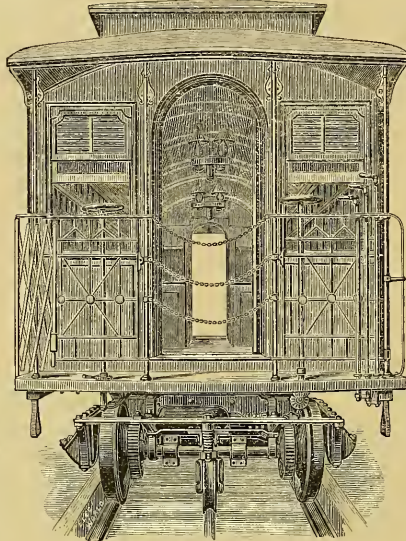

FIG. 3.—END VIEW OF SPRAGUE CAR.

A NEW THING IN MECHANICS.

The gear wheels are of an especially fine grade of cast iron, and are of the same face as the pinions which mesh into them. The number of teeth in these gears is sixty-six; they are of the involute cut, so that if the motor should be moved to or from the axles slightly, the gears will still run perfectly true, with only a little more or less closeness of meshing. The pinions on the armature shaft are set so that the one is half a tooth in advance of the other. Ordinarily, it would be a very difficult matter to get the splines on both the armature shaft and the axle and in the pinion and gears, so that they would mesh smoothly when running forward and backward, and it was for the purpose of getting rid of this trouble that the adjustable split gear was designed. It is now only necessary to key the two pinions, one fixed gear, and the web of the other gear in position without any regard to their meshing. The motor is then swung into position, the hangers made to engage the axle, the caps are put on, and the motor being moved forward and backward two or three times while the bolts of the adjustable gear are slack, this gear will assume a perfectly correct position. The bolts are now tightened up and there is thus a nest of double pinions and double gears all meshing with absolute precision, no matter whether the motor runs backward or forward. The method of mounting produces a concentric

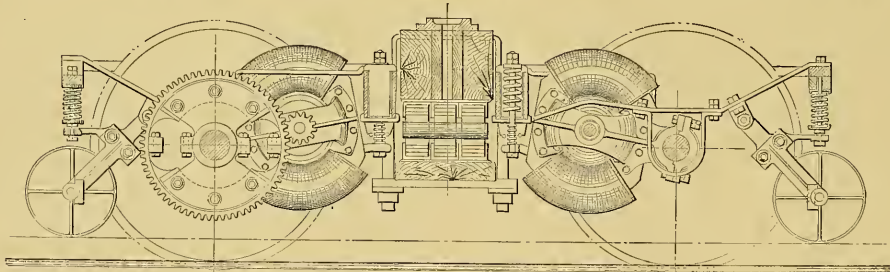

FIG. 4.—ELECTRIC RAILWAY TRUCK—ELEVATION.

forged steel pinions of 3 inches face and 3.7 inch diameter on the pitch line. There are thirteen teeth only. The hangers are extended and embrace the axle, which is turned off to a perfectly smooth surface, leaving a small shoulder at each side. Part of the hangers extending from the magnet pole-pieces embrace one-half of the axle, and the opposite half is embraced by heavy bronze caps, and inside each there are split liners to take up the wear. The armature shaft, as it passes through the hanger, is carried by two curved self-concentrating sleeves. On the axles, close to the hub of the wheels on each side, are two split gears.

motion, and by this means the driving and the driven axles are maintained absolutely parallel in two planes under all circumstances. To allow the motor freedom to follow all the movements of the independent axles over frogs and switches, and also for taking part of the weight of the motor off the body of the axles and to throw it on to the boxes, one end of the motor is suspended at its center by a bolt passing through the cross girders. This bolt is adjustable, and the upper part is held by a very stiff spring in a state of compression, which spring is in turn supported by a wrought iron saddle. The motor is then, so to speak,

weighed or flexibly supported from the body of the truck. There is also a smaller spring to take up any back movement or tendency to lift of the motor. This suspension is directly in the center of the pole piece, and the field magnets, which are grooved in the form of a circle, are independently detached from the pole pieces, one of them being put on after the motor is in place.

The operation of this mechanical movement, or method of mounting motors, has exceeded the expectations of its designer. Because of the relation between the teeth in the pinion and the split gear, it is necessary for the armature shaft to make sixty-six revolutions before the teeth engage in the same way, and each tooth of the pinion must in turn engage every tooth in the gears. It will be seen also, since the motor is suspended at one end by the truck axle and at the other by compression springs operating in both directions, that whenever the axle is in motion there is always a spring touch, so to speak, of the pinions upon the gears. Barring friction, a single pound of pressure exerted in either direction will lift or depress the motor a slight amount. It follows that no matter how sudden a strain, nor how great, it is impossible to strip the gears unless the resultant strain is greater than that of the tensile strength of

and the utmost precaution is taken in putting on the different coils of wire to insulate them, both from the body of the armature and from each other, by the use of a material which offers very high resistance to inductive discharges. The commutators are built of the finest copper, and no insulating material is used other than that just mentioned, and fine selected mica. One of the fundamental features of this system of electrical propulsion is to get rid of all adjustments and to reduce it to the simplest possible system of working, and at the same time to maintain as high an efficiency as possible of the motors themselves. For this purpose it was necessary, because of the limited space available, to make the motors of light weight, and yet capable of developing a very intense magnetic field. The form adopted for these motors has given these qualities. The motors themselves are built entirely of the finest selected scrap iron, specially forged.

A motor when running, it is observed, may be considered as a dynamo driven by a current. It generates an electromotive force dependent upon its resultant strength of field and the speed of the armature, and is independent of all other things. It follows that if the field magnet be under proper control, this counter electromotive force is

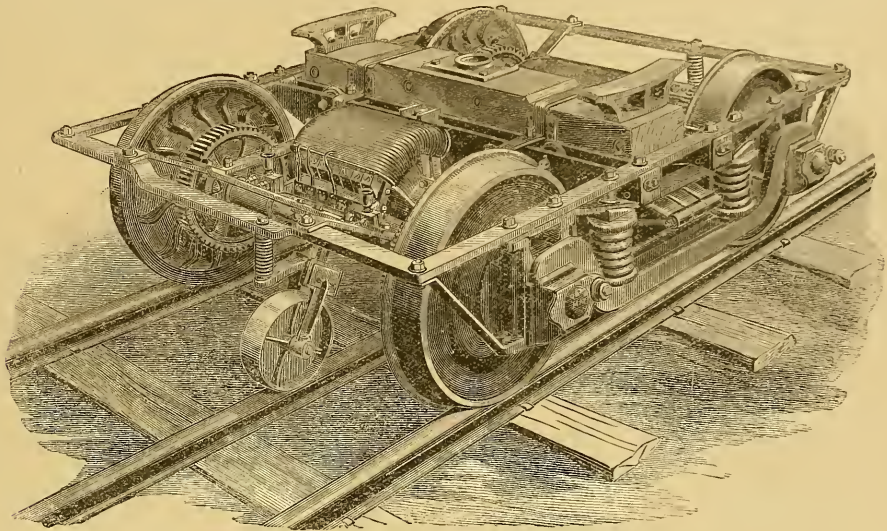

FIG. 5.—SPRAGUE RAILWAY MOTOR AND CAR TRUCK.

the iron; because the moment that the motor exerts a pressure upon the gears, at the same instant do the spring supports allow the motor to rise or fall so as to give somewhat, and no matter how sudden the strain is brought upon the gears it is always a progressive one. The result in practice has been, that with a weight equivalent to two tons upon each 30-inch wheel these wheels have actually been skidded in continuous rotation upon a dry track, and the strain necessary to do this amounts to from 1,500 to 2,000 pounds upon each gear. Strain has also been put upon these gears as suddenly as it is possible to close a circuit without injurious effect, across 600 volts. Designs for motors, mounted on these principles, of about 300 horse-power, are now being made; and such motors will soon be constructed, it is said, and forthwith put into operation.

The armatures shown in the drawing have a special modified form of the Siemens winding. The shafts are built up of the finest forged steel, and the body of the armature is built up with alternating layers of tissue paper and very thin iron discs, such as are used in the Edison machine, which reduces the heat loss due to Foucault currents to a minimum. The difficulties first experienced in dealing with currents of such high electromotive force and large volume have now been overcome, we are assured. The bodies of the armatures are thoroughly japanned and baked,

under perfect control under different speeds, and can be made greater or less in relation to the initial electromotive force, and consequently the motor can be made to do whatever work is desired of it. This system of handling a motor, which is an essential departure from previous methods, has been carried out to its logical conclusion in braking the train, which is done by partially detaching the armature from the main line when its motor electromotive force is equal to that of the initial, at which moment there is no current flowing through it, and closing it upon the same local regulating apparatus which is used for regulating the speed and power, and the first step of braking. By this means the train can be brought to a full stop. All these steps of braking are under the most perfect control, but if necessary the braking can be so sudden as to cause the wheels to have a continuous skidding rotation; not such a skidding as is caused when an air brake is put on too hard, but a rotating slip which will be just enough to relieve the armature when the strain on it has come to a certain point. And with the switch in position for the last step of braking, the car can be allowed to creep down the maximum grades at a snail's pace with a movement so slow as to be almost imperceptible.

At each end of a car, as shown in Fig. 3, there are three vertical switch rods, each connected by movable links with rods running through from one end of the car to the other.

These rods have projecting fingers which operate the levers of three very rapidly-moving switches; the movement of these switches is independent of the rapidity of movement of the hand, which simply stores up energy until a certain point is reached, when the lever is freed and the switch thrown over automatically. These three switches are employed as follows: One for breaking the main circuit; another for reversing the armature circuit; and a third for detaching the armature partially from the line and closing it upon a local regulating apparatus. The movement of the handles on the vertical rods are similar at each end. Forward motion of one means forward movement of the car; forward movement of another means closing the main circuit; and a forward movement of the third means also a throwing off of the break circuit. So that when a man stands at either end of the car, precisely the same movements mean the same thing as he looks up the track. In addition to these three vertical rods, there is a fourth rod which connects by a beveled gear with a rod running through

main circuits both run to fusible cut-outs before they reach the main braking circuit, and the armatures are also independently supplied at both ends with similar cut-outs. The armatures and the field magnets are all in parallel circuit with each other. Two independent motors are simultaneously controlled from the same regulating source; and, by the methods employed, it is perfectly possible to control 20 motors in the same way.

An interesting résumé of the distinctive features of the Sprague Electric Railway system, so far as it has been elaborated and developed, is given by *The Electrical World*, as follows:

A double-track system with motors working in parallel circuit with each other on a constant potential circuit, the two tracks being supplied from the same source and from the same main conductors.

A supply at two or more points by independent batteries of automatically non-sparking machines, the points of supply being maintained at the same differences of potential.

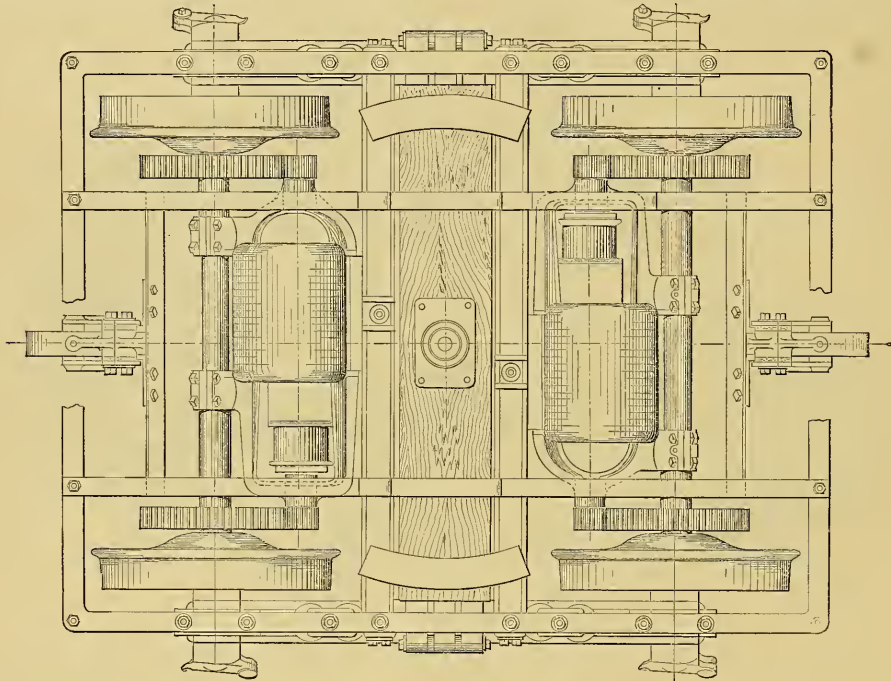

FIG. 6.—SPRAGUE CAR TRUCK PLAN.

underneath the car, and provided with universal joints so as to allow of any necessary adjustment. The top of this rod carries a wheel very much like a brake wheel, and it connects with a regulator which consists of a series of resistance coils. These are so arranged that by the continuous movement of the regulator handle they are first cut out of the armature circuit, while the field is maintained at a high saturation, thereby raising the armature potential, and then cut into the field circuit in reverse manner, thereby weakening the field. This regulator governs also both steps of braking the train.

The current is taken from the center rail by three conductors, two of which are bronze wheels working on pivoted arms under compression springs. They are provided with adjustable nuts to regulate the tension, and lock nuts to prevent the wheels dropping more than a certain limited amount when leaving the middle rail. The arrangement of contacts is such that the car will span 30 foot paces without breaking the circuit. The other part of the circuit comes through the wheels of the truck, so that one part of the apparatus is continually grounded. The collector and the

A system of continuous main conductors, intersected by switches, and sectional working conductors connected therewith through automatic safety devices.

Means of cutting-out, either automatically, in case of accident, or at will if desired, any portion of the circuit.

An automatic block signal system for day and night use.

Methods for the equalization of potential by cross connections between conductors of like polarity and on different tracks.

A very simple construction of the motor proper.

The centering of the motor upon the axles so as to maintain parallelism between the driving shaft and the driven axle.

The method of flexibly supporting a part of the weight of the motor from the truck so as to allow perfect freedom in following the motions of the independent axles.

The method of doing away with all shock and jar and danger of stripping the gears, and the maintaining at all times of a spring touch so as to prevent any backlash and to insure quiet running.

Double driving from opposite ends of the motor shaft.

The use of fixed and adjustable split gears.

The means for getting a very intense rotary effort in starting by having an intense magnetic field and raising the armature potential gradually.

The means for maintaining a continuous and equal traction until full potential has been reached.

The method of increasing or decreasing the mechanical effects, whether of speed or power, or both, by an inverse varying of the field magnet strength.

The method of controlling two or more independent motors simultaneously from the same source and by the same apparatus.

The use of a single resistance for both the armature and field circuits, each working independently.

The method of winding to maintain the point of least sparking at a fixed position, independent of the load, speed, or power.

The use of single sets of brushes for both forward and backward motion.

A system of braking consisting in converting the energy of the train into current, which is delivered back to the line through the same apparatus which propels the car without any reversal of contacts, whereby a saving of at least 40 per cent. would be effected in the size and capacity of the generating station, in the conductors, and in the coal and labor expended at generating stations.

The final step of braking by means of which the car is brought to rest through the same dynamic action of the motor while the field magnets are still connected with the line.

The method of lighting cars and stations from the main station.

The method of heating cars with a part of the energy of the momentum.

Such is the Sprague system as it is now being actively developed. It is the result of a long and careful course of study and experiment, and is justifying the confidence which has attended its progress.

It has received the most emphatic indorsement of one of the highest scientific authorities in the United States, that of Prof. Henry A. Rowland, of Johns Hopkins University, who closed a long report with the following significant statement:

"Altogether, there is no doubt in my mind that Mr. Sprague's method of working motors for electric railways is thoroughly scientific, and that it has many advantages from a practical point of view. It is also decidedly more economical than any other that has been brought to my notice, and will certainly accomplish what is required in such a case, namely, the moving of a train of cars from one station to another in the least time, with a given maximum speed, and with the greatest economy of power and least wear and tear of machinery."

A considerable assemblage of spectators was attracted during one of the experiments, and one of them describes the sight thus: A single passenger car on the Elevated road moved up and down the track on the line between the Third Avenue Station and the Thirty-fourth Street Ferry without a locomotive. The car was brilliantly lighted with a score of incandescent electric lights, and was occupied by a party of ladies and gentlemen. At intervals as it glided along the track a blue flash shot out from under the car, and a shower of sparks followed. Mr. F. J. Sprague, the inventor, stood at the regulator and directed the speed of the car, which sometimes ran at the rate of twenty miles an hour between the stations. The electric lamps were furnished from the same current, which was generated half a mile away. The trial was thoroughly satisfactory, though the weather was stormy. Among those on the car were General James Jourdan, of the Kings County Elevated road, Chief Engineer Sloan, of the Manhattan road, and E. H. Johnson, president of the Edison Electric Light Company.

THE drivers and conductors of the Lynn end of the Lynn & Boston Railroad have signified their desire of joining the Massachusetts State Order of Railroad Men, and an assembly will probably be organized in Lynn in a short time.

Legal Proceedings.

The North Chicago City Railway Co. President Yerkes has gained a marked victory against the lawyer (Allan C. Story) who petitioned for a quo warranto against his company, which was incorporated last May. The original North Chicago City Railway Company was incorporated under the act of 1859. The Chicago West Division Railway Company was incorporated under the act of 1861. But the first street railway of Chicago was ordained in 1856 (paralysed by the panic of 1857), and a new ordinance was passed in 1858, which was legislatively approved by the act of 1859; thus the south side system, under the name of the Chicago City Railway Company, was established by the same act as the aforesaid original northside company. An act was passed in 1865 amending the Charters of the Chicago City Railway Company (on the south side) and the Chicago West Division Railway Company. These enactments were set out in the petition in question, as well as the ordinance passed by the city council in regard to the new north side company, alleging that the old north side company has transferred all its rights to the new company, and that the latter has no right to operate a street railroad because the original charter of the old company restricted it to animal power, whereas the new company proposes to use steam-power. It also alleges that the statutes of the State of Illinois require the consent of a majority of the property-owners before any authority can be given by the Council to lay down or use a street railway track. It says the new company has never obtained permission of a majority of the property-owners, and also that no ten days' notice with a presenting of the petition to the common council was ever given. The summons was returnable Dec. 3, but the other side took out a summons to dismiss the petition, which secured a hearing sooner, and Judge Rogers made an order dismissing the proceedings Nov. 29. In the meantime the preparations for laying the cable system on the north side had been pushed vigorously.

Lessee and lessor at war. The New Orleans and Carrollton Railroad Company issued an injunction restraining Daniel Darms, saloon-keeper, from carrying on his business in the premises leased to him by the Carrollton Railroad Company, corner of St. Charles and Napoleon avenues. The defendant has filed an answer and reconventional demand. The answer denies the allegations of the petition that it was defendant's intention to carry on or conduct a gambling house, but admits that he fitted out the corner end of the premises for the purpose of carrying on the business of a bar room, a traffic legitimate and recognized by law. The defendant prays that the injunction issued be dissolved and set aside, and the demands of plaintiff be rejected, and in reconvention he prays that the railroad company be compelled to pay him the sum of \$10 a day for every day during which defendant's bar room remains closed and his business interrupted because of the injunction, for \$500 attorney's fees and for \$4,500 damages, punitive and exemplary, because of the wrongful issue of the injunction.

Corporation Counsel Lacombe has sent a reply to Secretary Smith of the Tax Department, who asked for an opinion as to how the personal property of the Broadway Surface Railway Company should be assessed. Mr. Lacombe says that, as the corporation was dissolved and its charter repealed by the legislature, and as its property is in the hands of a receiver who lives in Rhinebeck, it is clear that the Broadway Surface Railroad Company must be considered as not in existence, while the personal property which it owned is no longer its property and cannot be taxed or assed to it. So much of its personal property as is held by the receiver must be assessed to him in the county where he lives, and the taxes must be paid there.

A verdict for the company. The suit against the Second Avenue Surface Railway, of New York, brought by a Mrs. Daly, in the Superior Court to recover damages for injuries received by being thrown from a car which started suddenly before she alighted, as she alleged, has resulted in a verdict in favor of the defendant company. A motion has been made to set the verdict aside, and to have another trial.

An Improved Cable Gripping Device.

The accompanying engravings illustrate an improved "Gripping Device," recently patented, which will operate in a simple, practical and positive manner, whereby friction and cramping are avoided. A leading object arrived at has been to avoid any sacrifice of invested capital by making it applicable to the platforms of the present style of horse-cars with but little alteration of, or injury to the same.

As seen in figure 1, *A* represents the ordinary form of street-car, having the usual platform with brake-rod, etc., at its front end. In this platform a curved slot, *C*, is cut or formed, the curve being the arc of a circle struck from the centre of front axle. To the middle of this axle a collar or sleeve is fastened, within which the axle rotates, and to this sleeve is jointed the draft-bar, which extends and connects with the capstan *D*, carrying the gripper. This capstan vibrates in the curved slot as the car reaches the curves, and has suitable anti-friction rollers, resting between its flanges and the edges of slot. The object in making the curved slot in the platform is to permit the gripper to be put on the platform and be secured to the front axle by a draft-bar, and at the same time allow the gripper sufficient lateral play to compensate for the distance in advance of the wheels of the car in turning curves. When the capstan is in the middle of slot, and the car is traveling in a straight line, the rollers of the capstan bear against the edge of the platform, and a

part of the draft strain of the cable is transmitted to the platform direct. Within the capstan is arranged the grip adjusting mechanism. This consists of a sleeve *D*¹ having a hand-wheel *D*² and a concentric inner shaft *D*³ having a hand-wheel *D*⁴. The sleeve *D*¹ has a screw thread of considerable pitch on its outer periphery, which meshes in a spiral groove in the capstan, and the internal shaft *D*³ has also a screw thread meshing into an internal spiral groove in the sleeve, so it will be seen that when the outer sleeve is turned by its hand-wheel, both the sleeve and the internal shaft are adjusted together, up or down the capstan; but when the screw threaded shaft *D*³ is turned, it passes down within the sleeve and is independently adjusted. The lower end of the sleeve has a swiveled connection to the vertical bars *G, G*, attached to the lower section of the gripper, while the internal shaft has a swiveled connection to the bar *F*, connected to the upper gripper section. It will thus be seen that when the sleeve *D*¹ is adjusted about its vertical axis, the entire gripper is raised or lowered, and when the inner shaft is turned the two parts of the gripper are adjusted in relation to each other. The illustration of these devices will be clearly understood by reference to Figs. 2, 7, 8, 12, and 13 of the engravings.



the springs having arranged therein a headed stud which limits the movement). In Fig. 8 the bars are shown swung away from the cable, while in Fig. 7 they are shown forced under the cable. On the centre of the cross-bar a nose, *H*, is formed, which presses under and lifts the cable onto the carrying pulleys. The middle pulley is of a much larger diameter than the others. The object of this is to bring the cable into a gradual bearing with the gripper in closing, and also to make a large carrying pulley out of the same to allow the cable to pass freely over when the car is stopped, so that, in stopping it, it is only necessary to lift the upper section to a height sufficient to release the cable from the outer gripping pulleys without raising the bar *F* high enough to allow the bars *G*¹ to swing from under the cable.

The upper section consists of plate *I*, having the four pulleys, two at each end, and when the gripper is closed upon the cable, they seize it and bend it to a slight zig-zag line, thus getting a firm hold. The pairs of pulleys at each end are not in vertical planes, but are set diagonally and at a reverse inclination to each other, which prevents lateral displacement of the cable in turning curves—one pulley of each pair of the upper pulleys is in a lower level than the other, the object of this is to avoid bringing all the upper pulleys in contact with the cable at once, thus permitting the cable to be gradually seized by the pulleys as the gripper closes, the lowest pulleys binding against the cable

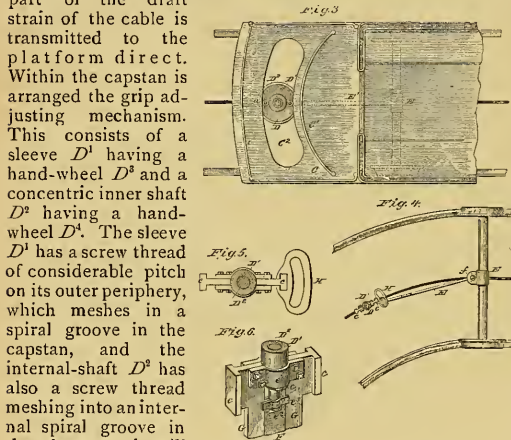

The lower portion of the draft-bar is loosely connected to a block, *H*, by a bolt, while the upper section is jointed to a collar on the capstan. This braces and strengthens the grip device, distributing the strain of the car, and serves to hold the bolt vertical. It will be seen that the gripper is capable of an axial motion about the middle and has also an articulate connection at the bolt *d* in the rear. This permits the greatest freedom from cramping or binding in turning curves, etc. See Figs. 5 and 6. As seen in Fig. 2, the bars *G, G*, are attached to the lower section *G*² of the gripper, and the bar *F* to the upper section, *I*, of the gripper. The operation of the two sections will be under-

stood from Figs. 7 to 11. To the side-bars *G, G*, are joined the hook-shaped swinging arms, which are connected by the cross-bar *G*², forming the lower gripping section. This gives the same a laterally swinging adjustment about a horizontal axis in passing beneath and from the cable. The slide-bar *F*, which carries the upper gripper section, has a cross head, having off-setting wings (Figs. 9, 10) which over-lap the upper ends of the swinging bars. (These bars have a limited, lateral movement, one of

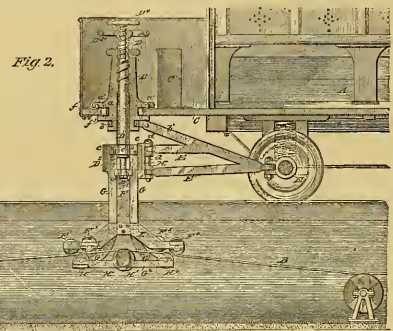

first, but still allowing the cable to slip through until finally, as the gripper closes tightly, the outer pulleys come into binding contact, and make a positive connection of the car. This prevents the cable and cars from being jerked by a too sudden connection, and avoids discomfort to the passengers, and also much injurious wear and tear of the cable.

By reference to Figs. 5 and 6 it will be seen that T shaped flanges are on both sides of the block *H*, this adapts

the gripper to be reversed and transferred from one cable to another as shown in Fig. 17. Figure 14 shows the device as adapted to dummy cars, etc. In this case the device is placed between the two wheels and connected to the two axles of same, or the device may be placed on a supplemental platform attached to axles as shown in Fig. 16.

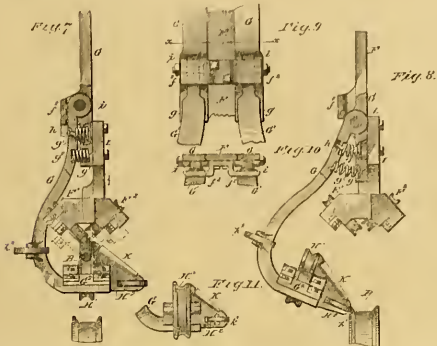

Safety and Success of the Manhattan Elevated Railway.

There can be no question now as to the popularity and success of the five-cent fare on the New York elevated railways. They have been in operation thirteen years. In the first year they carried 644,025 passengers and earned \$64,602. Last year the number of passengers was 1,151,095,91, and the earnings were \$7,426,216. The daily average of passengers carried last September was 315,369, but on June 5th of this year no less than 556,114 people were transported, the largest number ever carried in a single day, prior to Michaelmas last. "Considering this enormous traffic, the speed at which it is carried, and the rapidity with which trains chase each other up and down on the high trestle work, over the crowded streets of the city, the absence of accidents during the time the elevated roads have been operated is something extraordinary. It certainly shows clear-headed management and faithful and intelligent service in all departments."

During the first month since the reduced fare was adopted, viz., October, there were 12,488,198 passengers carried, being an increase of 3,080,946 over the month of October last year. It must be borne in mind that in 1885 the fare was five cents during six hours of each week-day, and ten cents for the remaining eighteen hours; on Sunday it was five cents all day. Last October the fare was five cents at all hours, day and night, over all the lines. And the increase of income, as well as the increased number of passengers, are clearly set forth in a statement, issued under the hand of Auditor Gaynor, of passenger traffic and

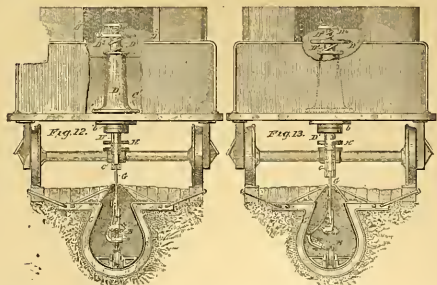

receipts for the first seven days of the past November, compared with the same during the first seven days of the same month last year. During first seven days of November, 1886, there were 3,134,806 passengers carried, and \$156,740.30 receipted; First seven days of November, 1885, 2,048,951 passengers, and \$134,787 receipted; increase,

1886, 1,085,855 passengers, and \$21,953.30. Average per day, first seven days November, 1886, 447,829 passengers, \$22,391.47; average per day, first seven days November, 1885, 292,707 passengers, \$19,255.29; being an average increase, per day, of 155,122 passengers, and \$3,136.18.

Among the "bulls" and "bears" of the Empire City, a false report was at first circulated that the reduced uniform fare did not pay. And after that was played out, advantage was taken of the crowds of passengers to insinuate that the "L." roads were in danger of breaking. The New York Sun published an alarming editorial to that effect, and emphasized "the possible danger arising from the vibration to which the structure is constantly subjected."

Col. Hain's reply thereto is interesting. He says: "The 'L.' lines consist of thirty-two miles of structure, all of which is double track. They are divided into spans about forty feet long, each span being independent, and the ends of the girders resting upon transverse girders supported by wrought-iron columns; in one type of construction the girders resting directly upon the columns. The material is the best refined iron for bridge purposes, and has a tensile strength of not less than 50,000 pounds per square inch, the Rapid Transit act requiring that the strains on the compression and tension members be limited to 9,000 pounds per square inch, the shearing strain on the rivets to be not more than 7,000 pounds per square inch, a maximum deflection of the girders to be not greater than 1-1500 of its length, the columns so proportioned as to have a factor of safety of 5, and the foundations not to have a greater weight come upon them than 2,000 lbs. to the square foot. With the increased weight of the engines now in use, necessary to draw five loaded cars, in no case is any portion of the structure strained anywhere near the limit above referred to.

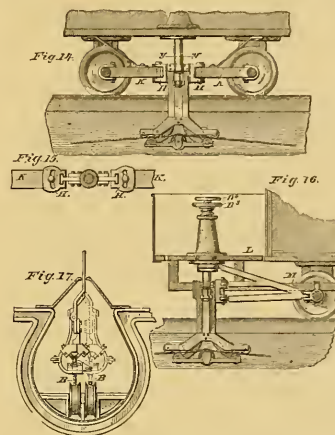

inspect the tracks and structure. Constant improvements are being made to relieve the structure from undue shocks, such as replacing fifty and fifty-six pound rail with steel rail weighing seventy pounds per yard, and the best devices for rail-joints are being tested." It may be fairly inferred that travelers by the elevated roads have no occasion, for the present at least, to be uneasy regarding the solidity of the structure or the care taken to guard against its deterioration. Still, it can hardly be said that the elevated road must be accepted as a permanency, and as the final solution of the problem of rapid transit. Increased facilities are yet urgently required. And it is still true that most of the inhabitants of the metropolis, who have given the subject any thought, look forward to the introduction at some future day of a still more secure, convenient and permanent system.

It is asserted that the street car of the future will have broad-tired paper wheels, running on asphalt pavement, and guided by wedge-edged guide wheels on the middle of the axles, running in rail with a V shaped groove. The cost of maintenance would be much less, and cars could be got back on the track again very easily. The only question is as to the behavior of asphalt with the car wheels constantly traveling over the same path.

THE
STREET RAILWAY GAZETTE

DECEMBER, 1886.—MONTHLY, \$2.00 PER YEAR.

COPYRIGHTED DECEMBER, 1886.

PUBLISHERS:

THE WRIGHT-MONROE COMPANY.

| | | |
|----------------------|-----------|------------|
| Augustine W. Wright, | - - - - - | President. |
| E. V. Cavell, | - - - - - | Secretary. |
| S. L. K. Monroe, | - - - - - | Treasurer. |

GENERAL OFFICES:

CHICAGO, - - - NEW YORK, - - - BOSTON.

CHICAGO:
43 LAKESIDE BUILDING.

| | | |
|-----------------|-----------|------------------|
| P. G. Monroe, | - - - - - | General Manager. |
| G. G. Minor, | - - - - - | } Editors. |
| William Hughes, | - - - - - | |

NEW YORK:
181 BROADWAY.

Henry C. Lockwood, - - - Resident Editor and Manager.

BOSTON:

198 WASHINGTON STREET.

T. P. Pemberton, - - - Resident Editor and Manager.

BRANCH OFFICES.

ATLANTA, Ga., Chamber of Commerce Bldg., Wm. Minnigerode, Manager.

SAN FRANCISCO, Cal., 1322 Pine St., G. W. Fairchild, Manager.

We regret being compelled, through the great demands on our columns, to hold over the continuation of Mr. Augustine W. Wright's article on the CONSTRUCTION, EQUIPMENT AND MAINTENANCE OF AMERICAN STREET RAILWAYS; as well as Chapter III of the HISTORY OF STREET RAILWAYS; together with an interesting paper on MECHANICAL TRACTION ON STREET RAILROADS, including "notes on experiments in Europe, 1870-1880," by E. E. Russell Traman, C. E. These, and an illustrated article on a "new crossing for street railroads," we hope to publish in our next issue.

THE history of the 5-cent fare in Cambridge, Mass., is interesting and instructive, especially in face of the city council's request for a reduction of the 6-cent fare to 5 cents, on the Cambridge (consolidated) street railroad, and the negative reply of President Cummings. The Charles River road was constructed to establish a 5-cent fare; "but, though it had the advantage of great economy in its construction and operation, though it started with road and equipment new, so that its expense for repairs was almost nothing, and though it was supported by a popular sentiment, leading to increased patronage and unusual privileges, still it never earned a dividend, and, in fact, made a very considerable deficit. The Union Railway Company maintained a 5-cent fare for one year, and made such a deficit that it threw up its lease of the Cambridge road. The latter road, on a 5-cent fare, paid an annual dividend of 3 percent. for the years ending September 30, 1883, and 1884, and since that time has paid 2½ per cent. semi-annually; the last of said dividends, however, on a 6-cent fare. The annual reports of the railroad commissioners show the extreme economy with which the road has been managed, the expenses being much less than those of the other Boston roads, and, in fact, the economy practiced was so excessive that large expenses for repairs have been, and still are, indispensable." Still the Cambridge road adhered to the 5-cent fare, hoping for an improvement in business, until it was subjected to an enforced rate of wages last spring, "and then it became a manifestly hopeless struggle if the road was to be properly repaired and any dividend paid whatever. Those facts led to the increase of fares, and subsequently led to the consolidation of the Cambridge roads, one great object of which was to save needless expense and hasten the time when 5-cent fares can be resumed. When and how

they can be resumed is the problem the present management are most earnestly trying to solve."

The eccentricities of the law have again been strikingly illustrated, in the case of Attorney-General Hunt against the Chicago Passenger Railway, or, as it is generally called, the Adams street line. This was an information filed by J. G. McConnell and others, owners of property at the corner of Fifth avenue and Adams street, charging that the Adams street company had no right to lay its tracks on Adams street, because it never had obtained the requisite consent of over half of the property-owners. The opinion, which was written by Judge Bailey, was a very able and elaborate one. He said there were only two questions to be considered—first, whether the Attorney-General had authority to bring such a suit as the present one; and, second, whether the company was obligated to obtain the consent of the property-owners. As to the first point, he held the Attorney-General, though having no statutory power to bring the present suit, undoubtedly had the right under his common-law powers. Secondly, the act of 1872 provided that a railway company must obtain the consent of the owners of a majority of the frontage along a street before it could lay its tracks on such street. The Horse and Dummy act of 1874, however, expressly provided that a petition to the Common Council only was necessary. Nothing was said about any petition or consent of property-owners. The object of the latter act was to have one uniform rule, applicable alike to cities, towns, and villages. The two acts were inconsistent and irreconcilable, and in accordance with well-known principles of law the latter act, as being the last exposition of the people's will, must be held to repeal the former where they clashed. The Horse and Dummy act evidenced the present will of the legislature, and, as it required no petition of property-owners, none was necessary. The information, therefore, presented no ground for equitable interference, and the decree of the court below, sustaining the demurrer to it, would be affirmed. The effect of this decision will be very far-reaching, says the Chicago *Tribune*; "Hereafter all that is required is the consent of the Council, and if that body chooses to grant a corporation the right to lay a track on Dearborn or any other street it can do it whether property-owners wish it or not. Heretofore there has been some check on the Council's granting rights of way, but now there is none, and probably within a short time a score of petitions for new street railways will be filed." THE STREET RAILWAY GAZETTE finds in the above decision, a great hindrance to the progress of street railways happily removed, and trusts that the *Tribune's* prediction may prove correct.

A decision which involves the immediate payment of \$49,000, and double that amount in a short time, by the Third avenue street railway of New York, has been made by the Supreme Court. Justice Lawrence has decided that that company must pay an annual license fee for each car run upon its route since December, 1852. There have been many suits pending against horse railways for license fees. One action against the Broadway and Seventh Avenue Company had been selected as a test case, and was argued in the Court of Appeals in October, 1884; and a decision was obtained in favor of the city. Under that judgment \$57,495 was paid by that road. Actions against the other roads are being vigorously pushed, and many of them have accepted the decision in the case mentioned, and settled the claims against them accordingly. In this way the Central Park, North and East River Railroad Company paid \$22,700, and the Forty-Second and Grand Street paid \$34,000, the Houston and West Street \$2,400, the Dry Dock and East Broadway \$77,000. Other roads, however, refuse to be controlled by the decision in the Broadway and Seventh avenue case and they continue to resist the collection of the fees in question; among these are the Eighth avenue road, against whom judgment was obtained by the city, in March, for \$43,000. An appeal against this judgment was argued Nov. 26, when Justice Lawrence directed the company to pay the \$43,861.28 (as per verdict) to the city.

THE formal opening of the Jersey City and Bergen Railroad Company's extension of their street railway across the Morris Canal into Bayonne, on Nov. 4, was hailed with enthusiasm by the residents of Greenville, Bayonne, and Bergen Point. A special open car, gayly decorated with flags and drawn by four handsome grey horses, resplendent in new harness and red, white and blue plumes, and containing President C. B. Hurston and Supt. T. M. Sayre, and several stockholders of the Jersey City and Bergen R. R. Co., J. H. Mulford, superintendent of the Bayonne division, and numerous officials and representative men, started from the Greenville car stables a quarter before nine in the morning, "amid the cheers of a large number of persons, who were unable to get on the car." There was a lively contest among the conductors and drivers who were there, off duty, for "the honor of paying the first fare on the new road." Conductor Joseph Brady was the successful one, and he also blew the first whistle. He refused a dollar, offered him by Judge Besson, of Bayonne, for transferring his privilege to his honor. Crowds of sight-seers lined the track, and as the car passed over the new bridge over the Morris canal "a great shout went up from the passengers." The horses, however, became frightened as they passed beneath the Central Railroad bridge, and almost pulled the driver (George Bowly) off the car. On arrival at the terminus of the road, at Kill von Kull, the party had to pass through a large and enthusiastic crowd to reach McDonald's Riverside Hotel, where the event was celebrated in a befitting manner. On the down trip the car stopped to take on two ladies, and arrived at the stables at 10:15. The trip gave entire satisfaction to the officials. The line was opened to the public the following Saturday, when "seven handsome and commodious jiggers" were put on.

The New York District Railway Company's case was before the Supreme Court (in General Term) since our last issue, on an argument against the motion for the appointment of commissioners to determine whether the company should be permitted to construct its proposed railroad from the Battery to Harlem River through Broadway and Madison-ave. G. P. Lowrey and Charles F. Stone represented the company. They were opposed by the New York Arcade Railway Company, the New York Underground Railway Company, and the Broadway Underground Connecting Railway Company, as well as representatives of property-owners. Decision was reserved.

The Court of Appeals has sustained the original position of Attorney-General O'Brien in his suit against all parties in the New York Broadway Surface Railroad matter wherein he sought to have the suit tried in Albany County, where he brought the action. A motion was made in behalf of the city for a change of venue to New York city, and this was denied by Judge Landon. The General Term, on appeal, reversed the decision and the highest court now sustains the original ruling. According to one of the provisions of one of the Broadway Surface Railroad bills, the Attorney-General was empowered to bring suit to wind up the corporation in an any county he might choose.

A motion which, it is said, has been pending since December, 1875, for the appointment of Commissioners of Appraisal to determine the amount of compensation to be paid to the city of New York for the right to use such of the streets and avenues as are proposed to be occupied by the lines of elevated and other railroads projected by the Metropolitan Transit Company, came before Judge Donohue Nov. 19 in Supreme Court Chambers. Many lawyers were present representing the city, the elevated railroads, the Broadway and Seventh Avenue Railroad, and the New York District Railway Company, and the New York Arcade Railway Company. The Metropolitan Transit Company claims to be organized under chapter 832 of the laws of 1872, and chapter 636 of the laws of 1881. It proposes to construct and operate various lines of railroad, both elevated, underground or depressed, and suspended, as already mentioned in the GAZETTE. No decision has been pronounced yet.

"ACCIDENTS" are sometimes very significant. While President Richardson (Atlantic Avenue R. R. Co., Brooklyn), and party were proceeding to "a lovely part of Greenville, N. J.," Nov. 11, to experiment with electric propulsion, a horse-car in which they rode thither broke down—thus demonstrating the unreliability of horse-cars; "so that the minds of the occupants were in a receptive mood when the electric railway was finally reached." And when President Richardson and party sat in a suspended car "shot back and forth through the air" by means of the Daft electric motor applied to the Enos System, they were inclined to feel that electric railways are the most superior. An amazed spectator describes the structure from which the car was suspended as "the elevated road cut in half." There were two rails, the motor being on the topmost. "The car was run up and down the track, around a sharp turn on a steep grade. It was easily controlled and stopped at any point by turning something that looked like the key of a music box in the forward end."

"By way of Beacon street" is one of the latest street railway projects which greatly exercises the minds of Bostonians. It is proposed to construct the best street railway "known to inventive skill, fitted with the best appliances known to modern times," to connect Boston and Brookline, by way of Beacon street. The project "is in the hands of men of character, competency, enterprise and generosity." There is also a respectable remonstrance. When the West Street Railway Company's petition came before Boston's Board of Aldermen, it was stated that the proposed road would be two and a quarter miles long, and that it was intended to widen Beacon street, and make it "the most beautiful avenue in America." The people living on the line of the proposed improvement have very largely promised to give their land gratuitously. The whole cost to the city of Boston, if the plan is carried into execution, will be \$34,000. The cost to the town of Brookline will be several hundred thousand dollars. If the location is granted by the city for the road, the West End Land Company promises to deed to the city all the land free of expense which it will be necessary to take in widening that portion of Beacon street which will come within the limits of the city of Boston. A number of remonstrances were presented. One strong objection to the scheme is the fact that the railway is to go over the Milldam road for a distance of 2,200 feet. The Milldam road is a popular pleasure ground, and strong objection is made to building a railroad upon it by those who use it. Mr. Welch said the only objection he had to make to the scheme referred solely to building the railroad over the Milldam. Mr. W. W. Vaughan, for the remonstrants, said if Mr. Whitney would make a proposition to widen that portion of the contemplated railway line which is to pass over the Milldam, all remonstrance would be withdrawn. Dr. Ira L. Moore appeared as a remonstrant, and characterized the whole matter as a land scheme. He thought that one street should be left where a man could drive a fast horse within the limits of the city. The most peculiar circumstance connected with this project is that the city councilmen do not seem to know exactly how they stand in reference thereto. The matter has been referred to a committee, but Mayor O'Brien claims that that committee has no right to consider the subject intrusted to it, but that it is solely the duty of the street commissioners. Therefore, whatever report the committee may make will be inoperative. This opinion is based upon the Acts of 1871, Chapter 96, which statute provides that the street commissioners, with the concurrence of the city council, "may widen Beacon street westerly from Gloucester street, Brighton avenue northwesterly from its intersection with Beacon street, and Brookline avenue southwesterly from its intersection with Beacon street, to such width as they in their judgment shall deem to be for the common benefit of the inhabitants of said city, and said city shall pay for the land and property so taken, which highways and streets said city of Boston shall not be obliged to complete sooner than the city council of said city may deem it expedient so to do."

Ohio State Tramway Association.

The fifth annual convention of the Ohio State Tramway Association was held at the Beckel House, Dayton, Ohio, on Wednesday, November 17th, Mr. Charles B. Clegg, of Dayton, President of the Association, in the chair; and the following members present:—A. G. Clark, B. F. Haughton, John Kilgour, J. M. Doherty, J. Harris, and A. Everett, Cincinnati; C. Hathaway, H. A. Everett, A. G. Hathaway, J. B. Hanna, and M. S. Robison, Jr., Cleveland; A. D. Rodgers, and C. Hayden, Columbus; A. A. Thomas, C. B. Clegg, A. M. Lewis, A. W. Anderson, H. Perrine, R. I. Cummin, W. Jones, John Harris, M. P. Moore, C. J. Ferneding, and J. Stoddard, Dayton; D. W. Stroud, Springfield; J. A. Watson, A. E. Lang, and T. T. Shipherd, Toledo.

The President welcomed the Delegates to Dayton, and expressed satisfaction at the interest shown in that Convention, and the good work that had been accomplished, concluding with the hope that much might be effected in the future. The Treasurer's report showed a balance on hand of \$14.20. Mr. A. E. Lang, of Toledo, read an interesting paper on

THE STREET RAILWAY PATRON.

He said: The disinterested patron, who is satisfied with the working of the road, has not yet been heard from, nor the man who does not know just how the road should be run to benefit the public, instead of a "grasping monopoly." Our patrons are divided into two classes:—those who become such of necessity, and those who ride for pleasure or convenience. We give to all the same invitation, but we do not fulfill our highest duty, unless we give to all the best facilities we can afford, viz., speedy transit and clean and comfortable cars. Poor track, irregularly laid switches, and cheap horses, are inconsistent with speedy or proper transit; unclean, ill-ventilated, hard seated, poorly-lighted and unpainted cars, are incompatible with comfort. All these we promise to our patrons, and if not given to them, have they not just cause to complain? If we do not expect to give the public a properly constructed and equipped road, then it should not be built. Once built, no effort should be spared to fulfill all our promises, and meet the expectations of the public. Mr. J. Kilgour, Mr. Robison, Mr. Doherty, and Mr. Clegg, related their various views of the "patron," and the discussion was very amusing and suggestive.

Upon invitation of the President, Mr. A. G. Clark, of Cincinnati, spoke on the

CAUSE OF ACCIDENTS,

giving it as his experience that a large percentage of accidents on Street Railways was ascribable directly to the injured parties being under the influence of liquor. He said that his company could almost always effect a satisfactory settlement with claimants if they could treat directly with them, and as soon as possible after the accidents, but not when considerable delay had taken place, and the matter handled by attorneys. Mr. Kilgour held it of vital moment that the conductor should always be provided with printed blanks, and to be instructed to take the names of all parties present at the time of the accident, for witnesses. This proposition was endorsed by Mr. A. A. Thomas, of Dayton, who emphasised the importance of having the exact spot, where an accident occurs, marked at the time by the conductor or driver. Mr. Stroud related some of his experience and advocated the fighting out of all claims—unless confronted with a preponderance of damaging evidence. Mr. Rogers (Columbus) thought that the main trouble was with juries, it being a matter of impossibility to get an impartial jury, and advocated seeking legislation to remedy the evil by providing for special juries for such technical cases. It was a remarkable fact, he said, that his road had had no accidents ascribable to parties being under the influence of liquor; but the greater number occurred to parties riding on the front platform.

In answer to Mr. A. G. Clark, Mr. Harris said that they had just as many accidents to parties riding on the rear, as on the front platform. Mr. Lang considered it im-

portant to personally interview the complainant and witnesses as soon after the accident as practicable. Mr. Stoddard, of Dayton, said that 75 to 90 per cent. of accidents were due to awkwardness of parties getting on or off a car, and to the carelessness of drivers in starting their cars prematurely; he advocated the careful training of such employes, and depreciated the hurried adjustment of cases by compromise. He related an interesting and peculiar case of a lady who "settled" with the company but re-sued them on the grounds that she was not aware of the full extent of her injuries at the time, and obtained judgment for \$2,000. Mr. Anderson, of Dayton, stated that he believed the cause of the above result was that the party did not fully understand that the first "settlement" was intended as a "final" one. Mr. Clark remarked by way of explanation of his preceding statement, that the majority of the accidents on his road were traceable directly or indirectly to liquor, that the stock on his road were familiar with the bell, and rarely started till the conductor gave the signal. Mr. Clegg had but one accident traceable to liquor. Dr. Everett, of Cleveland, thought the subject had been pretty well exhausted, but stated that his road had never yet been compelled to pay a judgement: he personally investigated all accidents, the majority of which, on his road, occurred to parties riding on the front platform; his conductors were all provided with blanks for names of witnesses, and several instances of hypothecated cases were related in which suit had been entered for damages sustained by parties in the dim past, and of which no possible trace could be obtained. Mr. J. B. Hanna, of Cleveland, said that his company always obtained the most satisfactory verdicts from a "struck" jury. Mr. Chas. Hathaway said that his experience demonstrated the fact that the plaintiff in a damage suit could always find enough witnesses to prove anything he or she wanted. He never knew an accident to occur on his line with "closed front" cars, and thought that riding on the front platform was conducive to accidents, and he advocated the abolition of the rule permitting passengers to smoke on the front platform, or in substitution therefor, to have gates placed on either side of the front platform. He discouraged the building of tracks in too close proximity to each other, and related the particulars of an accident to a lady and gentleman in a buggy in which the man lost his suit, but the lady recovered \$2,700 it being held that the man, while driving, was guilty of contributive negligence, but the lady was not.

Mr. Shipherd had a case in which a lady got injured in a car; her doctor recommended a settlement of \$5,000, alleging that the injuries received would kill her in a week; but upon a personal interview, the case was compromised for \$200, and within a few minutes afterwards the old lady was discovered washing dishes.

Upon motion, duly seconded, it was decided to publish in full (embracing same in Secretary's report), a tabulated statement of accidents, compiled by Mr. Collins, Secretary of the Cincinnati Street Railway Company.

After recess, the Secretary of the Association (Mr. H. A. Everett) read an interesting paper on

MUTUAL BENEFIT ASSOCIATIONS,

in response to the desire of several members of the Association to ascertain the *modus operandi* of the Employes' Independent Mutual Benefit Association, which has been in operation upon the lines of the East Cleveland R. R. Company for some time. The said company undertook to pay dollar for dollar to the general fund, and provide a meeting-room free of charge, subject to certain conditions which have already been recorded in THE STREET RAILWAY GAZETTE. It is managed by nine directors, only one of whom is appointed by the company. It has 94 active members, and its treasury possesses \$235. The initiation fee is \$1.00, and monthly dues \$.25. The allowance being \$1.00 per day during sickness, or when disabled. It is proposed to apply a portion of the funds to supply newspapers and magazines for the meeting-room. It has also been voted that a member should be allowed a rebate of all moneys paid in, in the case of dismissal or resignation, provided that

such member has received no benefits while belonging to the Association, and minus his proportion of expenses paid by the Association.

A very excellent and scholarly paper, entitled "The unpopularity of Corporations; their clause and Remedy," was then read by Captain A. A. Thomas, of Dayton; and it was listened to with deep interest. This closed the reading of prepared papers, and, upon motion of Mr. Stroud, a vote of thanks was returned to the gentlemen who had, in the preparation and reading, added so much to the interest in the convention, and the instruction of the delegates.

It was resolved, upon the recommendation of the Executive Committee to make an assessment of 25 cents per car, to cover expense of printing and publishing reports of Convention, etc. The Nomination Committee, consisting of Messrs. Lang, Stoddard, and Thomas, announced the names of the following gentlemen as their choice for offices of the Association for the ensuing year, who were formally elected:—President, D. W. Stroud (Springfield); Vice-President, J. M. Doherty (Cincinnati); Secretary, H. A. Everett (Cleveland); Treasurer, J. B. Hanna (Cleveland). And for Executive Committee (with officers), T. F. Shipherd, Toledo, Ohio. The next meeting is to be at Springfield, Ohio, the third Wednesday in November, 1887; and the following gentlemen were appointed to prepare papers for next year:—(1.) The purchase and disposition of horses, including relative value with mules, Mr. J. Harris. (2.) The detection and punishment of dishonest employes, Mr. J. B. Hanna. (3.) Present and needed legislation in Ohio, Mr. A. A. Thomas. (4.) Uniforms, rules, and discipline, Mr. A. D. Rodgers (Columbus). (5.) Eccentricities of members of the O. S. T. A., Mr. Geo. B. Kerper (Cincinnati).

The newly elected President (Mr. Stroud), having been officially escorted to the chair, acknowledged the honor paid him. So did Mr. Doherty. Mr. A. G. Clark suggested that, on account of the unpropitious weather generally prevailing at this season of the year, the time for holding their Annual Convention should be changed. But after considerable discussion the matter was left *in statu quo*. In response to Mr. Lang's inquiry, it was announced that several of the roads represented charged passengers less than the fares they were legally entitled to.

THE BANQUET.

At half past eight o'clock in the evening, the business part of the programme having been completed, the delegates, and a few invited guests, assembled in the ladies' parlor of the Beckel House and proceeded to the dining room to partake of the Banquet tendered to the visitors by the street railway companies of Dayton. Horace Fox, the proprietor, is one of the best known hotel men in the State, and never did he so thoroughly show his proficiency in his art to such a degree as upon this occasion. The floral decorations were most charming, and boutonnières were laid upon every plate. The menu, which was prettily gotten up, was as follows:—

MENU.

Blue Point Oysters on Half shell. From Sac. Consomme. Celery, Boiled Halibut, Orleans Sauce, Parisienne Potatoes. Olives, Fresh Lobster Farcis in Shell, Saratoga Chips. Broiled Quail, with French Peas, Creamed Potatoes. Pineapple Sherbet. Mumm's Dry Verzenay. Chicken Salad. Assorted Cake, Vanilla Ice Cream, Fruit, Nuts, Raisins. Roquefort, Crackers, Cigars, Coffee, Cognac.

The viands were good, the wines irreproachable, the services excellent, and those present furnished the wit, laughter and appetites. The Hon. Samuel Craighead, in a brief, but well chosen speech, bid the guests welcome to the Gem City, and regretted that it was not the right season to see the city in all its glory. Mr. J. M. Doherty responded on behalf of the visitors, and assured the hosts that their hospitality was most heartily appreciated. Mr. Stroud (the newly elected President) extended a cordial invitation to all present to honor Springfield with their presence at the next convention, and promised to entertain them royally.

Mr. E. V. Cavell, Sec. of the STREET RAILWAY GAZETTE, at the request of the Toastmaster, spoke for the

railway press, showing many reasons why it should meet with the heartiest co-operation at the hands of the street railway fraternity. He briefly referred to the imperfect detective system at present in vogue, and advocated the establishment of a central detective, or inspection bureau, for the exclusive use of the street railways; by which means, competent men could be secured in lieu of the present "go as you please" set that now apply for such work.

Mr. Charles Hathaway said that the last words he heard prior to leaving home were, "Now, don't, pray don't try to make a speech, for you know you cannot," from his daughter; he thought it was an imposition on him, this "speechifying," as he had not even tried to make one since '62, his last being on the occasion of the street railway banquet in London, England, in that year; and when the news thereof reached his Philadelphia friends they all thought that he must have been drunk at the time, etc., etc. The following gentlemen also helped to entertain the gathering with "wit and wisdom":—Mr. A. G. Clark, of Cincinnati, Mr. R. M. Nevin; John W. Stoddard; A. E. Lang; Fred. Brownell; Henry Everett; T. F. Shipherd; A. D. Rodgers; etc.

Ohio Convention Jottings.

Universal regret was expressed at the absence of Geo. B. Kerper, whose wit and geniality have always done so much to "Keep the pot a bilin'" at past conventions.

Mr. Chas. B. Clegg presided, both at the convention and the banquet, and he handled each gathering with grace, dignity, and universal courtesy.

Mr. Fred. Brownell, of the Brownell & Wight Car Co., drifted in "promiscuouslike" and seemed at home with every one.

Fulton Foundry, Cleveland, O., was well represented by its able Secretary, Mr. Chas. Langdon.

In spite of his "game leg" (that would have made most men "boil" with irritability) the Supt. of the Cincinnati St. Ry. Co. took an active part in all the proceedings, and bore his pain like the man he is. Mr. Harris is a Stoic.

A wise move, that of the Association, in re-electing its most efficient Secretary for another year. The best man for the position is considered good enough for the O. S. T. A. Friend H. A. E. "Here's tae ye."

Mr. D. W. Stroud, in whose city the next annual gathering will be held, declares that he won't be out-done in entertaining the delegates next year, and will open negotiations at once with the proprietor of the Louvre with a view of engaging his chef de cuisine for the Springfield banquet. The Champion City is proverbial for its hospitality, but it will have to hump itself to get away from its lovely sister—Dayton.

Mr. A. G. Clark always commanded attention whenever he had the floor.

Need we say that the smiling face of Mr. Chas. Hathaway graced the occasion?

Why, oh why did the gallant Toastmaster fail to respond to the many calls for "The ladies?" That delightful subject is always a welcome one when handled by Mr. C. B. Clegg.

THERE are no less than 36 street railway corporations in the State of Ohio, of which 20 are members of the O. S. T. A.; and these 20, as shown by the assessment sheet, own 5,424 horses and 1,965 cars. The "outside" 16 companies have 671 horses and 162 cars.

A new warmer for street-cars and other vehicles, is on the *taps*, which would seem to be simple, economical and unobjectionable. It consists of fixing a tank under the car filled with compressed gas, and of sufficient capacity to carry a day's supply. To this tank is attached two ½-inch pipes running in two corners of the car and up inside an iron tube six to eight inches in diameter, under the car seat, and therein a couple of Bunsen burners are fixed, and the product of combustion is carried off at the other end of the car. This, it is said, warms the car, and can be easily regulated.

Accidents.

John Richards, a molder, of Cleveland, was run down and killed by a street car at Youngstown, Ohio, on the night of Nov. 20.

A young man, named Matthew Lambert, was run over by a street car at Louisville, Ky., on the night of Oct. 27, and died of his injuries five days later. The driver of the car was threatened with prosecution for manslaughter, but the coroner's jury returned a verdict of accidental death.

A fire engine ran into a street car at New Orleans, Nov. 28, damaging the car to the extent of about \$75. The engine was proceeding to a fire, and the car was stopping at a street corner for a passenger to alight. The car was full of passengers at the time and it is astonishing that some of them were not injured. One of the horses of the engine was forced into the rear door of the car.

A Texas Pacific R. R. locomotive dashed into, and wrecked a street car at a railroad crossing in Dallas, Texas, at 10 P. M., Oct. 22d. No one was seriously injured.

At Houston, Texas, a mule kicked a street car driver in the face, Oct. 28, while he was assisting to replace a derailed car. His nose and jaw were broken and his face badly crushed. He was removed to the hospital, where he remained unconscious for a long time and was expected to die. He has recovered, however, and his face is but slightly disfigured. His eye will probably be useless, but that was defective before the accident.

Two men and a boy escaped, not only serious injuries, but death, the last Saturday night in October. About six o'clock, just as the shades of darkness were thickening, an expressman with his boy (aged 8) and two neighbors were proceeding in a buggy along North Clark Street, Chicago, and fell into the cable cutting (about 8 feet deep) opposite the main entrance to Lincoln Park; horse, buggy and all were thrown in a heap, the men bottommost. They were, however, imbedded in soft soil, and, ultimately were got out unhurt (except fright and shaking). The men were quite sober, and say there was no light on the side of the cutting.

Correspondence.

234 Broadway, New York, Nov. 4, 1886.

EDITOR OF THE STREET RAILWAY GAZETTE:

In the September issue of the GAZETTE, there was a biographical sketch in which a false impression is conveyed, leading your readers to infer that the success of the Tenth Avenue Cable Road of this city was attributable to the subject of the aforesaid sketch.

I waited for your October number, expecting that a correction would be made in same, but, as this was not done, concluded in justification to myself to make the correction which to me seems merited.

It is a fact that can be easily substantiated, that the Tenth Avenue and 125th Street Cable Road was designed and detailed throughout by me alone, and I have yet to learn of one detail designed, or improvement made by the subject of the above mentioned biographical sketch.

As I am dependent upon my labor for maintenance, I could not afford, from a financial standpoint, at least, to allow this to pass unnoticed.

Respectfully, D. J. MILLER.

Engineer of The American Traction Rope Railways.

"Who is your artist?" is an oft-repeated question, in reference to the portraits of prominent street railway men whose features are presented from month to month in the STREET RAILWAY GAZETTE with so much fidelity and artistic excellence. We have much pleasure in stating that Mr. G. Higgins is the man, and he is employed by the firm of Blomgren Bros. & Co., of Chicago.

"The car is full of alumni," whispered Miss Beekonstreet to her friend from the West, as they both journeyed Cambridgeward in the horse-car. "Yes," said the Chicago girl, "and how it chokes one up, don't it? I wonder they do not open the ventilators."—*Boston Commercial Bulletin.*

Jay Gould's Invention.

Jay Gould has become an inventor as well as a capitalist. He noticed while traveling on the New York Elevated Railroad that the elbows of passengers whose arms were extended over the top of the backs of seats were liable to be dug into the backs of passengers in front. He discovered that this was the source of a great many quarrels and a large amount of profanity among the passengers of the elevated roads, and at his suggestion it is being obviated by having a thin piece of ornamental board added to the backs of these cross seats, thus interposing an effectual barrier between competing elbows and backs.

In The Caves of Adullam.

I.—Buffalo "Max."

The self-appointed censor of the Buffalo system of surface transportation, having for a time been quiescent, erupted again over the euphonious nom-de-plume of "Max," in the Buffalo *Express* of Oct. 24, and, in the masterly eloquence characteristic of those "inbriated with the exuberance of their own verbosity," devotes nearly a column to a howl at the officers of the Buffalo street railway companies.

Having been there ourselves we can heartily sympathize with an editor being at his wit's ends to satisfy the demands of a crying public, but, while appreciating that most trying position, it does not appear clear to us why alieology should be prostituted to deceive such public by gross misrepresentations and adroit perversion of facts.

The "hair brained chatter of irresponsible frivolity" we refer to consists of long tirade against the alleged "illiberal and unaccommodating spirit which seems to pervade the management of our street car system," and, while giving the companies credit for having "good roads, horses, cars and men," protests against what this alleged critic is pleased to designate "unsatisfactory service," etc. After berating the companies for neglecting to give the public \$2.75 for every \$1.00 earned by them, and scoring them for failing to pursue a ruinous course of idiotic experiments, he coolly reminds the objects of his wrath that "a few additional crews of men would enable the company to put on more cars at" [we presume he means "during"] "the crowded hours, and would allow of cars being run at intervals between midnight and 5 o'clock in the morning," and "this would not entail a dollar of increased outlay on the part of the company."

If "a few additional crews of men" "would not entail a dollar of increased outlay," why could not President Watson get his 500 employés to work on the same terms, and have the exquisite gratification of seeing the stock of his company soar into the empyrean? Great scheme! The owner of a brain as massive as that in which such a dividend paying scheme was evolved should not hide his shining light in a town so insignificant as the Queen City of the Lakes; he had far better enter into negotiations with Mr. C. B. Holmes, of Chicago, where the passenger travel increases about 15,000,000 in one year.

We have heard of the "Buffalo Zephyr" but this outward and visible sign of its mundane materialization inclines us to the belief that it is a "Zephyr" of cyclonic proportions.—E. V. C.

THE question of right of way, or, to speak more correctly, right of rails, is evidently coming to a head in Chicago, where Justice Meech is up in arms against cabmen, truckmen, expressmen, in fact all who drive teams and obstinately refuse to leave the car tracks, notwithstanding the fact that the conductors request, the passengers implore and the drivers yell to them to get off. Every day for some weeks one or two of these fellows have been arrested and fined, and still the good work goes on. The officers have been instructed to stop this nuisance, and they are evidently doing their best. On the 22d ult., Hugh O'Brien, a typical teamster with the idea that the car-tracks were laid for his especial benefit, monopolized the Madison street line from Fifth avenue to Clark street, and then, while trying to stop an east-bound car that he might pass, ran the tongue of his wagon into the car. He paid \$5 and said he would never do it again.

Street Railway Patents.

The following list of recent patents relating to inter-mural traffic is specially reported for THE STREET RAILWAY GAZETTE, by William G. Henderson, Solicitor of American and Foreign Patents, 925 F Street, Washington, D. C. A copy of any of them will be furnished by him for 25 cents.

- Issues of October 5th, 12th, 19th, and 26th, 1886.*
- 350,138. Car starter—D. Jennings, Lyons, N. Y.
 350,220. Car starter—W. H. Vail, Cleveland, Ohio.
 350,263. Tram car—J. Menzies, Kyneton, Victoria.
 350,146. Bell alarm for elevator cars—J. W. Metz, Manchester, Ohio.
 350,168. Operating railways by cables—J. Stewart, Newark.
 350,428. Soda motor—A. J. Grafenstatt, and W. Tweedie, Minneapolis, Minn.
 350,813. Cable grip—T. O. Cooper, Wilmington, Del.
 350,585. Cable gripping device—J. A. Goldstein, Brooklyn.
 350,890. Car brake and starter—J. F. Morrell and C. Tilton, Camden, N. J., and Philadelphia, Pa.
 350,661. Car brake and starter—T. & T. Cox, Jr., Gloster.
 350,525. Brake handle for street cars—F. B. Brownell, St. Louis, Mo.
 350,515. Underground electric cable—B. Williams, Chicago, Ill.
 351,139. Automatic car brake—H. A. Wahlert, St. Louis.
 351,130. Convertible street car—P. J. Smith, and J. F. McEvoy, Long Island City, and Brooklyn, N. Y.
 350,989. Car starter—H. C. Percy, Natchitoches, La.
 351,036. Cable railway grip—D. D. Anders, Philadelphia.
 351,254. Grip for cable railways—E. D. Dougherty, Philadelphia, Pa.
 351,124. Mechanism for actuating the clutch and brake in cable railways—J. H. Pendleton, and C. Tiers, Brooklyn.
 351,559. Car starter—R. T. P. Allen, Farmdale, Ky.
 351,481. Car wheel—R. N. Allen, Cleveland, Ohio.
 351,430. Cast steel car wheel—H. W. Fowler, Chicago, Ill.
 351,498 and 351,499. Metallic railway tie—E. C. Davis, Crookston, Minn.
 351,449. Railway transfer table—J. N. Kaufholz, Cleveland.
 351,440. Automatic switch for street railways—J. Hope, Jr., Providence, R. I.
 351,501. Gripping device for cable railways—F. G. Dieterich, Washington, D. C. (*Illustrated on pp. 334 and 335.*)
 351,693. Permanent way of railways—A. C. De Barbaran, New York, N. Y.
- Issues of November 2nd, 9th, 16th, and 23rd, 1886.*
- 351,983. Cable grip—C. A. Howe, Philadelphia, Pa.
 351,793. Draw hook for street cars—A. Rapp, Pullman, Ill.
 352,002. Railway tie—E. F. Reynolds, Bruce, Dak. Ter.
 351,996. Metal tie for railway tracks—C. Netter, New York.
 351,901. Grip for cable railways—E. D. Dougherty, Philadelphia, Pa.
 351,997. Gripper for cable railways—T. O'Connell, Brooklyn, N. Y.
 352,255. Cable grip—G. Muller, Hoboken, N. J.
 352,350. Cable grip—E. Samuel and V. Angerer, Philadelphia, Pa.
 352,126 and 352,127. Car starter—G. B. Haines, Chicago.
 352,167. System of motors for electric railway brakes—C. J. Van Depoele, Chicago, Ill.
 352,113. Rail for railway curves, etc.—L. Brigham, Osseo.
 352,265. Electrical railway—E. E. Ries, Baltimore, Md.
 352,782. Car starter and brake—C. A. Shank, Philadelphia.
 352,587. Apparatus for removing and replacing the wheels and axles of railway cars—H. Sym, Montreal, Quebec.
 352,763. Curve pulley construction for cable railways—H. M. Lane, Cincinnati, Ohio.
 352,834. Switch for overhead railways—J. Moyer, Philadelphia, Pa.
 353,178. Cable road grip—S. H. Terry, Fulton, Mo.
 353,005. Mechanism for operating cable supporting sheaves—J. H. Robertson, New York, N. Y.
 353,108. Street car heater—T. Wiseman, Lawrence Kas.
 353,259. Brake pawl for railway cars—G. H. Griggs, Providence, R. I.
 352,985. Propulsion of cars by compressed air—J. M. Thompson, and F. Jones, San Francisco, Cal.

New Literature.

Square Root Made Easy. Dr. Robert Grimshaw, M. E., the well-known editor of *Mechanics*, prefaces his neat and useful little book, entitled as above, saying, "There are many cases where it is desirable or necessary for a mechanic or other practical man, not a mathematician, to take the square root of a number or quantity. Many have not sufficient book training to enable them to attempt it, and the rules in most books are so complicated or so confusedly explained as to make the task difficult and the result unreliable even to those who have access to the book rules. Hence I have prepared this little SQUARE ROOT MADE EASY with a view to its being useful." And very useful it is. New York *Mechanics* Publishing Co., 5 Dey Street. Price 25 cents (mail free).

Pocket Atlas of the World. Or, the whole world in a pocket-book, one might say, in its new and revised edition, contains 191 pages, 5¼ x 3¼ inches, and shows over 5,000 miles of recently constructed railroads on the ninety full-page colored maps it contains. The first is a miniature map of the world; then follows Europe (3 maps), British Isles (3 maps), and after showing the rest of the world—east, south, north—North America is represented. And almost last, but not least, are maps of all the States and Territories of the Union. The last map is that of Central America and the West Indies. There are also forty-eight colored diagrams, together with a complete index. It is a kind of condensed cyclopaedia, replete with general and statistical information of great value. Seldom have we seen so small a book containing so much interesting and valuable knowledge. It is indeed a striking specimen of *multum in parvo*. Chicago; Rand, McNally & Co., Monroe Street. Price 25 cents (mail paid).

Gearing. We have received the new edition (tenth) of Poole and Hunt's list of Gearing, a handsome book containing 146 pages. There is a full page reproduction of an engraving of their cable driving plant, which they have made a specialty, and such as they have supplied to some of the principal cable street railway companies. The gearing information given is most valuable. Baltimore, Md., Poole & Hunt, engineers, etc.

Personals.

WILLIAM H. HAGGARD, President of the Brooklyn City R. R. Co., has resigned. It is expected that Seth L. Keeney will be his successor, but action has been postponed till January.

Mr. W. B. PARSONS, JR., engineer of the New York District R. R. (underground), has been appointed chief engineer of the Fort Worth & Rio Grande R. R., in Texas; and has left to commence operations; he retains his connection with the District Railroad. Mr. Parsons was formerly road master in the N. Y., Lake Erie & Western R. R., and is the author of the well-known book on "Track."

MR. ARTHUR A. ANDERSON, Secretary of the Citizen's Street Railway Co., of Indianapolis, is the proud possessor of a nice pounds girl. "Let the guid wark gang brawley along."

THE HON. GEO. B. KERPER, of Cincinnati, certainly cannot be styled a non-producer. Within this year he has produced a splendid cable road, and a eleven pounds boy. And we are pleased to learn, by latest advices, that "father and son are doing as well as can be expected under the circumstances."

OUR old friend Bert Cross, the popular manager of the Lexington City Ry. Co., Ky., was united in marriage to Miss Lula Byrnes on Tuesday, the 7th. inst. The ceremony took place at the residence of R. K. Byrnes, Esq., father of the bride, at 2 o'clock in the afternoon, and was of a strictly private character, none but intimate friends of the contracting parties being present (except our correspondent). The STREET RAILWAY GAZETTE stretches its arms above the happy pair with a hearty "God bless you, my children."

J. O. HADDOX, Private Secy. to H. H. Littell Esq., Supt of Louisville City Ry. Co., celebrated the advent of a 10 lb. girl, on the 29th ult.

MR. JULIUS WALSH, of St. Louis, says he feels quite patriarchal, having, on Thanks-giving day, received another addition to his family. This is the ninth.

THE Pullman Palace Car Company has secured temporary injunctions restraining the collection of taxes on its cars in Nebraska, Kansas and Iowa. Some of these fine days the Pullman Company will ask for the earth and the fulness thereof, and will be sadly disappointed at a failure to get it.—*Courier Journal.*

Pointers.

ALABAMA.

Attala. A street railroad is to be built to Gadsden; work will commence early in December, and O. Christopher is making enquiries for second-hand rails from 16 to 35 pounds.

Birmingham. The Highland Avenue & Belt Railroad has been incorporated.

Mobile. The Mobile Street Railroad Co. will convert the warehouse, 305 feet by 115 feet, recently purchased, into a stable, car shed, and workshop; building and improvements to cost \$10,000.

Montgomery. The Capital City Street-railway Company, after running Van Depoele's electric motor system over the Court-street line uninterruptedly and successfully for six months, have increased their capital stock from \$50,000 to \$75,000, and have ordered another three miles western extension, adding six cars, all run by electricity, for which a monster generator of 150 horse-power is being constructed.

Selma. A company is to be incorporated to construct and operate an electric street railroad.

Sheffield. \$30,000 have been subscribed towards building a two-mile street railroad from Tuscumbia to Sheffield. A. J. Moses of Sheffield is interested. An electric street-railway is also contemplated.

ARKANSAS.

Texarkana. The Texarkana Street Railroad Co. has applied for right of way, and is preparing to commence operations.

CALIFORNIA.

Alameda. Columbus Bartlett will begin work in about two months on the Park-street railway, and may possibly use an electric motor, such as is used in Los Angeles, on one of the roads there.

Los Angeles. A franchise has been granted to H. N. Galloway and others to construct a cable railroad on Grand avenue.

Oakland. The Oakland, Broadway & Piedmont R. R. Co., owned by Theodore Meetz, was recently granted a charter for a line of street railroad; the Mayor vetoed the ordinance, and the City Council re-passed it over the veto.

The cars for the new cable line in Oakland are almost finished. They are being built at John Hammond's California carworks, and are of the combination pattern like those on Market street. The total length of the cars is 25½ feet, the dummy is ten feet long, the car twelve feet, and the rear platform three and a half. In point of finish they are said to be superior to anything ever made on that coast. The interior is of Eastern ash, the windows are extra large, and the trimmings are nickel throughout. The trucks are of the latest pattern, with very powerful brakes. The painting, which has been done by William W. Pahl, is very handsome. The body of the car is a bright carmine and the lettering and ornamentation are in gold.

San Diego. The San Diego Land & Town Co. will build a motor line between National City and San Diego.

An electric railroad is to be built on the Enos system. D. G. Dexter is interested.

San Francisco. Gustav Futro has petitioned for a franchise for a street railroad on First avenue.

The Automatic Connection Compressed Air Car Motor Co. has been incorporated by Z. McKinnin, C. A. Zeesley, S. C. Pressley, John M. Patterson, and M. J. Henley. Capital stock, \$1,000,000.

The Jackson & Powell street cable road is progressing. W. H. Martin, John Bellard, W. J. Adams, Thomas Magee, H. H. Lynch are the directors. The Pacific Rolling Mills has received an order for \$500,000 worth of rails and other ironwork, and the company has purchased a fifty-acre lot on the northwest corner of Washington and Mason streets upon which to erect its engine house, and its proposed route has been definitely located. It is to proceed along Mason street, Montgomery avenue, Taylor and Bay streets, and back to Powell street. A new cable railroad is to be built along Castro street, thence south to Twenty-sixth street, by the Market Street Railroad Company, as soon as the property owners along the line shall properly sewer the street.

COLORADO.

Denver. The Denver Street Railroad Co. will build a four-story and basement stable and barn, 60 by 125 feet, adjoining the present one near the Union depot. John Roberts is the architect; estimated cost, \$30,000; materials, brick and stone.

CONNECTICUT.

New Britain. A company has been formed by Lorin F. Judd and others, with a capital of \$23,000, to build a street railroad.

DELAWARE.

Wilmington. The Wilmington & Brandywine Street Railroad Co., capital stock of \$25,000, proposes to build a line from the depot of the P. W. & B. R. R. to Riverview cemetery, a distance of two and one-half miles, by way of French street. Particulars may be obtained of George R. Townsend, 614 Market street, Wilmington.

FLORIDA.

Fort Meade. A new street railway will be built in Fort Meade. J. A. Edwards, president; J. C. Carter, treasurer.

Orlando. "Now we are to have a street-car line," says the Orlando Reporter, in pointing out the evidences of the "permanent growth and prosperity" of the city, "which six years ago to-day was a little pine woods hamlet." * * * About that time the editor of the Reporter was pointed out as an escaped lunatic, for venturing to publish the prediction that in ten years Orlando would have a population of twenty-five hundred." The present population, it is said, now reaches "upwards of

four thousand of the liveliest, most active and most progressive people on the continent." The Orlando and Winter Park Street Railway Co. has been incorporated, and has secured its right of way. Dr. R. E. Green, of Gainesville, Ga., is the principal stockholder and manager.

GEORGIA.

Atlanta. A new railroad is contemplated for Atlanta. Address Colonel E. P. Howell.

Brunswick. A street railroad company is to be incorporated by R. B. Reppard, W. E. Kay, C. P. Goodyear and others.

Dublin. A street railroad, one mile long, is being built by J. M. Smith from the town to the W. & D. R. R.; the Oconee river will have to be bridged. Freight and passengers will be carried.

Macon. Many improvements are projected on the street railroad; these will be carried out before any extensions are built.

Savannah. The City & Suburban Railroad Co. will lay new rails on the Whitaker and Bay street line.

ILLINOIS.

Chicago. The Chicago West Division Elevated Railway Company has been incorporated with a capital stock of \$10,000,000. Anson H. Lawrence (2 Howland Block); Edward T. Cahill, and George H. du Puy, incorporators. The company proposes to build and operate an elevated railway from some point between the lake and the South Branch, and between Lake and Harrison streets, to a point on the west side of Cook County, with branches leading to Humboldt Park, Stock-Yards, Douglas Park, and corner of Western and Blue Island avenues.

The Chicago Rapid Transit (Cable) Railway Company was incorporated Nov. 10; capital stock, \$2,000,000; incorporators, Charles E. Apponyi, Frederick B. Shelton, and Edward Kemble (94 Dearborn street).

The Electric Elevated Railway Company has been incorporated (Oct. 25); capital stock, \$5,000,000; to construct and operate elevated railways in Chicago and Cook County; incorporators, Charles W. Rigdon (80 Dearborn street), Silas S. Willard, and George P. Everhart.

Successful experiments have been made by the Chicago West Division Railroad Company for heating the cars, and there is considerable likelihood that some general system will be adopted when the weather grows colder.

The Chicago Passenger Railway Company has opened up a new street-car line which greatly adds to the facilities of transportation between the West and South Sides. The new line of cars run on Harrison street, from Western avenue to Center avenue, thence north to Adams street, and east to Franklin. Here the cars take alternately different directions around a "loop"—one car runs northward 3 or 4 blocks (to Washington street) then east, to Michigan avenue, proceeding southwardly to Adams and back to and past the Franklin street turning, while the next car goes around the same loop in the reverse direction. This loop system, which entirely does away with switching, was originated by President Harvey T. Weeks. And he celebrated his birthday by putting on fourteen new and stylish cars on this line. There are 25 new cars in all, the other eleven having been put on in celebration of his previous birthday, when the Adams and Harrison Street line was started. The 14 newest cars are white in color. They were built by the Pullman Palace Car Company, and are the handsomest street cars we have seen, of that company's make. Each is elegantly upholstered, has plate-glass windows and a plate-glass mirror at each end. These cars, marked "Washington and Adams," attract unusual notice as they pass along.

The Chicago City (cable) Railway Company have been busy for some time constructing new cars, at their own shops, for State street and Wash and Cottage Grove avenues. Twenty-five new cars were put in hand, and they are being put into service as rapidly as possible. These new cars are of the same dimensions as the old, but otherwise there are many improvements. The colors—red and white for State, and dark blue and white for Wash and Cottage—are still retained, but the windows run clear up to the roof, instead of carrying the names of the streets on a seven-inch strip above them, and this gives the car a much more airy and pleasant appearance. Then the raised deck for ventilation extends the entire length of the car, instead of only covering the center, as in the old ones, and the street names are cut with sand blast in glass that corresponds with the distinctive color of the cars. They are finished in light hardwood, and both seat and back upholstered in red or dark blue plush. All departments of the shops (at State and Twenty-first streets) are rushed with work, making repairs and finishing the new cars. Then some of the cable drums that have been running five years are being replaced. The foundations for the new 1,000 horse-power engines are being built in the north end of the engine-rooms, and when they are placed the machinery will be completely duplicated so that the two north or two south engines can be run either separately or together.

The Chicago Remunerating Elevated Railway Company is said to be backed by New York and Philadelphia capitalists who have from \$5,000,000 to \$15,000,000 to put into the enterprise. The road will run through Hyde Park and zig-zag its way to Kensington, in order to accommodate the most people possible. Agents are at work on several routes in the city, and only the managers know which one will be selected. About twenty miles will be constructed.

The city council had before it (Nov. 29) two ordinances which were referred to the Committee on Railroads, both from the Chicago City Railway Company, providing for the construction of additional tracks on Dearborn Street and other streets and sections on the South Side. The various tracks are to be built within two years after the passage of the ordinance; provided, that should the construction of any one or more of the lines in question be delayed by injunction of any court, the time so lost shall be added to the time specified within which the same shall be constructed; and, provided, that, should any portion of any of the lines

not be completed within the time specified; the rights shall be forfeited only on the unbuild portion thereof. The cars shall be operated only by animal power, except that it shall be lawful for the Chicago City Railway Company at any time within the term of the ordinance to adopt its so-called cable system on any or all of the lines specified, the same to be constructed and operated as provided by and subject to the conditions of the ordinance of Jan. 17, 1881, authorized the said company to operate its cars by other than animal power. As regards filling, grading, and paving of the streets or parts of streets to be occupied by its tracks, the company shall fill, grade, and pave and keep in repair sixteen feet in the centre of the streets occupied, in manner provided by Sec. 2 of the ordinance of July 30, 1883, relating to street-railways. The right to use granite blocks in the paving of its lines is thereby expressly granted to the company. The rate of fare shall not exceed five cents for any distance between Madison street and the terminus of each of the proposed lines, and passengers on the Twenty-second street line shall be transferred from it to or over any of the north or south lines crossed without any additional fare. The grant shall extend for the term of twenty years from the passage thereof, provided the same shall be accepted by the company within thirty days after its passage.

The North Chicago City Railway Company is also seeking right of way on Dearborn street, from Jackson to Washington, thus invading the South Side. But the company of which Mr. Holmes is president is first in the field, as stated in the preceding paragraph, and a bitter contest for right of way on Dearborn street may be expected, especially on the part of property owners, the street in question being the only one, on the South Side business centre, except Market, that has no tracks upon it. The Chicago City Railway Company, however, think it unnecessary to seek the consent of property-owners, because the Council is authorized, by a private charter granted to the company in 1859, to give it "a right of way on any street that it sees fit."

Elgin. The Elgin City Railway Company, at Elgin; capital stock, \$50,000; incorporators, George P. Lord, William Grote, Richard P. Jackson and others.

Hyde Park. The Hyde Park Board of Trustees passed an ordinance, Nov. 1, granting the Chicago City Railway Company a franchise to construct and operate a line of double-track cable railway on Cottage Grove avenue from Thirty-ninth to Sixty-seventh streets, and on Fifty-fifth street from Cottage Grove avenue to Lake avenue. The improvement will cost \$1,000,000, and will be commenced as soon as the frost is out of the ground in the spring. After the ordinance was passed, the trustees were serenaded by the interested property-owners who favored its passage. The entire village government was driven in carriages to Oakland, where a supper was served. The ordinance stipulates that passengers will be carried from Fifty-fifth street to Madison street for five cents.

President Holmes, Nov. 15, applied for an ordinance granting the company the right to make a loop for the end of the Fifty-fifth street line, around the two blocks, and presented the consent of a majority of the property-owners on said streets. The petition was referred to the Streets Committee. On Nov. 21, the trustees received a protest against the granting of the "loop" in question, which was also referred to the committee.

On Nov. 15, the Chicago Rummernating Elevated Railway Company, by its manager, J. J. Richards, presented a petition and ordinance asking the board to grant them permission to use and occupy such streets, highways, and public property as shall be thought to be to the mutual benefit of said company and village. A provision is made, however, that the company shall, before being permitted to use any streets, obtain the consent of at least one-half of the frontage on any street. The company is to begin work on the tracks inside of twelve months from the date of the ordinance, and the charter is to remain in force for ninety-nine years. Single fares shall be five cents; twenty fares or over, four and a half cents each. The road proposes (in lieu of taxation) to pay the village \$1,000 annually per mile for the first year, \$2,000 annually per mile for the next ten years, \$3,000 per mile annually for the next ten years, \$4,000 per mile annually for the next ten years, and \$5,000 per mile annually thereafter. The proposed route is west of Grand boulevard from Thirty-ninth street to South Chicago.

Jefferson. The Chicago Suburban Street Railway Company was licensed by the Secretary of State (Illinois), Dec. 4; capital stock, \$200,000; incorporators, Oliver H. Horton, Thomas M. Hoyne, and Paul Brown. It is proposed to construct street railways in the town of Jefferson and other suburbs of Chicago.

Peoria. A short but lively strike took place here, Oct. 24. The car-drivers of the Central City Horse-railway Company, embracing four out of the five lines in this city, had their stools removed, by order of the company; and they abandoned their cars as fast as they arrived at the stables; and by 11 o'clock not a car on the lines was running. This continued until 2 o'clock in the afternoon, when the company gave them their stools and the drivers returned to work.

The Peoria East Block Railroad Co. (capital stock, \$11,000) are constructing a mile and a half of track, 4 feet 8 1/2 inches, with heavy rails, to be opened on or before the first proximo. Mr. N. Giles is the president.

INDIANA.

Fort Wayne. The Riverside Street Railway Co. has been incorporated to build and operate electric street railroads in the city.

IOWA.

Cedar Rapids. The Cedar Rapids and Marion Railroad Co. are extending their line nearly a mile, from 16th street, and on that street they are renewing their track for about a mile. They will shortly be running to Central Park, when they will put on a couple of new cars and reinforce their horse-power.

Clinton. A street railway will gladden the hearts of Clintonians in the course of a few months, it is expected. Mr. J. M. Harzell is pushing the project energetically.

Des Moines. The Narrow Gauge Street Car Co. has plans in hand for new repair shops to cost \$10,000.

Five miles of track have been laid by the Capital City Street Railway Co., which was incorporated five months since, and thirty horses, with six cars, are now running. Their whole line is over fifteen miles long, and the remaining two-thirds is being proceeded with as rapidly as possible.

The Mayor has vetoed the ordinance granting the Broad Gauge Railroad Co. right of way on certain streets. Right of way has been granted for an extension of the East Side line.

Dubuque. The right to use the new patent cable for street car, owned by J. K. Graves, of this city, and others in the State of Illinois, has been sold to a Chicago company for \$400,000.

Lyons. J. W. Harzell has been granted the right of way to construct and operate a street car line at Lyons.

KANSAS.

Abilene. The Abilene Street Railway Co. has been incorporated. Capital stock, \$50,000. J. B. Case, J. E. Bonebrake, John Johnst. C. Johnst, G. W. Hurd, A. W. Rice, M. M. Shipe, Theo. Mosher and W. B. Giles, incorporators.

Harland. The Harland Street Railway Co. has been incorporated. Capital stock, \$100,000. Edmund S. Snow, L. S. Jones, W. S. Handy, Wm. F. Flash, Benj. Bowen, W. F. Tabard and Logan A. Gortin, incorporators.

Topeka. The Topeka Rapid Transit Street Railway Co. of Topeka, has been incorporated. Capital stock, \$250,000. John Francis, John Norton, P. G. Noel, Jonathan Thomas, Armin Fassler, J. B. Bartholomew, Topeka, O.; S. Kelley, Springfield, O.; J. W. Morris, Leavenworth, and W. S. Arter, Pittsburgh, Pa., incorporators.

Wichita. The Riverside and Suburban Railroad Co. has been incorporated, with a capital stock of \$100,000, to build a line from this city to Riverside, to be operated by steam or electricity. The directors are J. O. Davidson, William Innis, H. G. Lee, C. L. Davidson and W. E. Stanley.

KENTUCKY.

Henderson. The Henderson Street Railway Co. will build a new street railway. David Bowles, Jr., is president. For further particulars, address J. F. Clay.

Louisville. The East Chestnut Street Railway is almost completed.

Owensboro. has become populous and prosperous enough to have a street railway. J. D. Powers, J. A. Fuqua and J. M. Alsop, of Nashville, Tenn., have obtained the right to build one, and the work is progressing. The length of the road is a mile and a half.

LOUISIANA.

Baton Rouge. A Street Railroad Co. has been organized with a capital stock of \$25,000. Three miles of line will be built. Reade and Goodale are interested.

Carrollton. The patrons of the New Orleans and Carrollton Railroad were "electrified by the appearance of two or three brand new cars" the beginning of November.

New Orleans. The Street and Landings Committee, of the City Council, having reported favorably, with amendments, on the ordinance relative to the right of way of the Orleans Street Railroad Co., the Council sold the franchises thereof "for and in consideration of the sum of \$10,000, payable in five years, in yearly installments of \$2,000 per year." The contract was approved Nov. 8. As stated in our October issue, the property of the Orleans Street Railroad Co. was valued at \$164,532.50 by the official appraisers, and it was expected that the franchises would have realized much more than \$10,000. In reference thereto *The Daily Picayune* says that the sale of the franchises (in question) "for a period of twenty-five years for the sum of \$10,000 for the entire period should be very disappointing to those who had looked to this sale for a considerable addition to the revenues of the city. Ten thousand dollars to be paid in five years seems a pitiful return for those franchises. Should like methods prevail in disposing of the Claiborne Street Road there will be but little to hope for in the way of a contingent fund for emergencies."

The Canal and Claiborne Street Railway is not yet disposed of on any terms at all. In reference to the sale of this franchise, Mr. Moon made a motion in the City Council, Nov. 8, for removing the track from Rampart to Basin street, and from Claiborne, above Canal, to Galvez street. Mr. Moon moved to strike out Broad street as the terminus and allow the company to make the terminus Carrollton Avenue Canal. He also moved that the repairs clause be left as in the original specifications. Mr. Shiger moved to refer the whole matter back to the Streets and Landings Committee. Mr. Moon objected to delay and said that by advertising at once a large revenue would be obtained for the city at an early date. He understood that outside parties would bid more than the railroad company would. No good could come of a conference with the railroad company. Ultimately the whole matter was referred back to the committee, which was met Nov. 15, but failed to do so. On Nov. 23, the company presented a petition protesting against the rights of way, privileges and franchises of said company, as advertised by the Comptroller, claiming that both sides appointed appraisers, and that their report, as published in the STREET RAILWAY GAZETTE for October, is final. In the meantime the city's budget includes a calculated income of \$60,000 from the Canal and Claiborne street franchise.

The St. Charles Street Railway Co. will have to pave their street with sheet asphalt, instead of plank paving, as provided in their franchise. But the city will pay the difference between the cost of plank and asphalt pavement.

The ordinance with reference to lewd women is to be amended, as far as limits are concerned, in certain localities through which lines of street cars are constantly passing.

The Common Street Railroad is to be extended to Carrollton bridge.

MAINE.

Waterville. A horse railroad is contemplated between Waterville and Fairfield.

MARYLAND.

Baltimore. The Baltimore & Highlandtown Street Railroad Co. is extending its line.

Bladensburg. A company has been incorporated to construct a street railway, to be operated by electricity, from near here to Washington—a distance of eleven miles.

MASSACHUSETTS.

Arlington. The Arlington Street R. R. Company, have increased their capital stock from \$13,000 to an amount not exceeding \$25,000. They had previously conferred with the Cambridge Street R. R. Co., with the view of selling or consolidating.

Boston. The Boston Consolidated Street Railway Company have awarded the contract for making winter uniform overcoats and suits, for their drivers and conductors, to G. W. Simmons & Co., Boston.

The employes of the Boston Consolidated Street Railway express themselves as highly pleased with the new time table, which materially lessens the hours of labor. The dissatisfaction among some of the men, in consequence of the readjustment of wages after the consolidation of the Highland and Middlesex street railways (Aug. 21), has died away. The payments complained of are \$2 25 per day to conductors and drivers of two years' standing, \$2,12½ for those less than two years in the service, and \$1,75 per day to "new conductors and drivers." All other conductors are paid \$2 a day. President Powers declares that this is the highest rate of wages on any street railway.

The president's report of the Consolidated for the portion of the year (41 days) ending Sept. 30th, shows an increase of 493,334 passengers carried, over the number for the corresponding period last year (by the Highland and Middlesex), and its net earnings for the 41 days was \$61,736.33, the capital stock being \$1,700,000. The length of railroad track is 40 miles, most of which is laid with steel rails weighing fifty pounds to the yard. They own 1747 horses and 349 cars, newly upholstered. And 106 new cars, of the most superior finish and workmanship, have been purchased from Messrs. Jones & Co., of Troy, expressly for the routes between Roxbury and Charlestown. Some extensions have already been made, and more are in prospect. And "the time has nearly arrived," says the report, "when the cable or electricity will be substituted to a considerable extent for the horses as a motive power."

The Metropolitan (Street) R. R. Co., have also furnished report for their financial year ended Sept. 30, showing net income of \$351,156, which is \$51,904 more than the previous year. Under the head of interest paid there is a decrease of \$9,995. They have paid \$120,000 (3 per cent) dividends for 1886, leaving a surplus of \$148,761; \$86,922; increase \$61,839. Total surplus, 1886, \$772,652; do 1885, \$733,891; increase \$38,761. The funded debt of the company is \$1,459,442 as against \$1,180,000 last year, and the unfunded debt \$125,620 as against \$591,630 in 1885, making an aggregate debt of \$1,583,063 as against \$1,771,630 last year. The cash assets are \$261,258, and the net debt \$1,321,804.

The South Boston Street Railway Co., has been heavily swindled by its late treasurer, who had held the position ten years. The company's annual meeting was held Nov. 16, when the auditors and retiring board of directors were unanimously re-elected. The report for the past year, showed liabilities \$1,084,459.19 (including a surplus of \$69,959.19), and the assets balancing that amount consisted of Construction account, \$302,738.14; horse account—903 horses, \$124,162.50; car account—199 cars, \$145,485; equipment account, \$38,998.54; land and buildings, 359,755.94; Supplies, \$58,370.27; track under construction and new materials, \$24,132.78; accounts receivable, \$14,505.29; cash, \$16,310.73; total, \$1,084,459.19. Only a few days elapsed before the business community of Boston were surprised by the announcement that the treasurer of the company (Wm. Reed) had been arrested on a charge of embezzling the company of some \$200,000. The fraud was carried on for several years, and his sin found him out through the appointment of Mr. Charles Hersey to the presidency some little time since.

Bradford. The new street railroad has recently been opened for traffic.

Cambridge. The total income of the Cambridge Street Railroad Co., for the fiscal year 1886 was \$701,808, against \$618,629 in 1885. Total expenses 1886, \$586,844; do, 1885, \$503,685; net 1886, \$115,013; do 1885, \$119,996. Interest paid 1886, \$20,168; do, 1885, \$20,162. Dividend 1886 (5 per cent), \$80,000. Surplus 1886, \$5,845; do, 1885, \$5,830.

President Prentiss Cummings has told the City Council of Cambridge (in reply to the request made by the Council) that the Cambridge Street R. R. Co. cannot reduce the fare to five cents at present. Mr. Cummings explains the reasons for this, and why it is necessary to maintain the six-cent fare which is now charged on the Cambridge cars. They have great special expense growing out of their transfer system. In the month of October, those transfers on their road amounted to 138,596. Spread out as Cambridge is, the privilege of transfer would be greatly missed if discontinued, yet it involves an expense of many thousands of dollars yearly. In conclusion President Cummings tells the City Fathers, "We are certain that you cannot regret as much as we do that the business and condition of the company do not at the present time warrant the reduction asked for; but you may be assured that we are giving the matter most careful study, with the

earnest purpose of making reductions as fast as may be, and yet keep the road on a fair business basis."

Fall River. At the recent annual meeting of the Globe Street Railroad Co., a dividend of two per cent was declared, and it was voted to increase the capital stock from \$200,000 to \$300,000.

Gloucester. The Gloucester Horse Railroad Co. has elected the following board: President, Morris G. Fitch; Vice President, Walter A. Jones; Secretary, David S. Presson; Treasurer, F. W. Homans; Directors, George Morse, W. A. Homans, Thomas Hodge, of Gloucester; J. P. Langmaid, H. O. Flint, of Salem; Henry Souther, J. H. Lewis, of Boston; W. A. Jones, of Troy, N. Y.; J. H. Brock, of New Bedford. The right of way has been granted for the extension to Rocky Neck.

President and Superintendent Morris C. Fitch, of the Gloucester City Railway Co., has got into a stubborn dispute with Surveyor Adams and the committee on highways, concerning the elevation of the railway track on Pleasant street. The city engineer located the track, but Alderman Wanson, who is chairman of the committee on highways, instructed Contractor Payson to raise the track four inches higher than located by the engineer, which was done. After it was laid, and the paving nearly finished, Alderman Wanson ordered the track lowered four inches. This order was not complied with, and while workmen were at work Nov. 4, laying the paving, Street Surveyor Adams with a gang of men, under directions of Alderman Wanson, commenced to tear up the paving, when Contractor Payson stopped work. The company say they will refer the case to the railroad commissioners to settle.

Holyoke. The Holyoke Street Railroad Co. has been asked to extend its line to the river, to connect with the steamer landing. If this is done, a new wharf will be built.

Lenox. A new electric railway, to cost \$150,000, is to be built by Mr. S. D. Field, from Lenox, through Curtisville, to Glendale, to accommodate the pleasure-seekers and health hunters of New York next summer.

Lowell. The interests of the street railroad companies are likely to clash; both the Lowell Street Railroad Co. and the Dracut & Lowell Street Railroad Co. have applied for additional locations in the western and central parts of the city. The latter company has tracks in Centralville, on the north side of the river, and wants to come over to the city and to have the former company move its tracks from the center to the sides of the main streets, so as to give room for the new tracks. The company has decided to increase its capital stock \$50,000, in order to carry out the projected extension.

Lynn. A double track street railroad is being laid from Chestnut street to Chatham street.

Natick. The Natick & Cohichuate Horse Railroad Co. has made the following report: Mileage, 17,541; passengers, 193,577; property and assets, 34,326; passenger earnings, \$12,180; total income, \$13,016.85; expense of operating, \$8,849.66; total earnings, \$12,769.43; surplus, \$4,112.52; net debt, \$5,213.48.

Newburyport. The Newburyport and Amesbury Horse Railroad Company, which was incorporated 14 years ago, has passed under new management. 386 shares of its capital stock have been sold by the company's president (Wm. A. Johnson), and the former lessee of the road (Edw. P. Shaw), to the Hon. Harvey W. Shepard, solicitor, of Boston, and he has resold the same to President Charles Odell, of the Naumkeag Street Railway Co., of Salem, and Willard B. Ferguson, the superintendent. The Hon. H. W. Shepard retains the stock which he has held for several years. The total stock at present amounts to \$60,000. An additional thirty thousand dollars will be spent upon the road and equipments; and it will be managed hereafter in the same vigorous and satisfactory manner which is now characteristic of the Naumkeag St. Ry. Co. Mr. Johnson and Mr. Shaw retire from the board of directors, and Messrs. Odell and Ferguson will take their places. In the last commissioners' report issued, the Naumkeag's net income for the year was \$19,744.10, while Newburyport and Amesbury H. R. R. is on the wrong side with a deficit of \$518.15 (and the lessee's balance to contra was only \$12.14). The change is likely to be for the better. The length of road is 6.4-5 miles. There are 53 horses and 12 cars.

Newton. A project is being discussed for the building of a street railroad, to be worked by electricity.

North Adams. It is proposed to extend the street railroad to Blackinton, as the present facilities for traveling between the two places are very limited. The land has been asked for, but has only been donated by one owner; the line will run across the fields and will pass under the railroad tracks.

Pittsfield. The hearing of the Pittsfield Horse R. R. affair before the Board of Railroad Commissioners, Oct. 5, "was suspended at the request of both parties, to be resumed at the request of either party."

Revere. The railroad commissioners gave a hearing, Nov. 9, to representatives of the town of Revere, who complain that the fares for scholars who attend schools in Chelsea and Boston have been unduly advanced recently. The decision of the commissioners is reserved.

Salem. A general strike was inaugurated, Nov. 23d, on the Salem & Danvers street railway, by order of the executive board of D. A. 30, Knights of Labor. The road is located in the jurisdiction of both D. A. 30 and 77, and for this reason but a portion of the men quit work, and cars were run all day, there being but a slight irregularity. Some weeks ago the management of the road made an agreement with their men to work for \$1.75 per day during the winter, as, it being a new road, they claimed they were unable to pay the rate paid by the older roads in this vicinity. The men accepted the reduction of 25 cents per day, but on the road discharging two men to reduce expenses, the matter was placed in the hands of the executive board of District Assembly 30, who notified the management that unless the pay was restored to the \$2 rate they

would order a strike, and eighteen of the thirty men left. Subsequently there was a general tie-up. But next day, as a result of a conference between Superintendent Cook, of the Salem & Danvers street railway, and the executive board of D. A. 30, Knights of Labor, the trouble was adjusted, the road paying \$2 per day, with the agreement that they might hire as many or as few of the old hands as they required, and run as many or as few cars as they chose.

Springfield. The Springfield Street Railroad Co. will soon increase its capital stock \$25,000, and will extend the line to West Springfield. The annual report of the treasurer gives the net profits at \$21,000. The company employs sixty-five men and uses 150 horses. A new line has been built through Walnut street at a cost of some \$10,000, and 1,400,000 passengers were carried the last year.

Stonham. The Stonham St. Ry., which is about 2½ miles long, has been sold to the Lynn & Boston R. R. Co., who will extend the tracks from the Melrose Highlands station, on the Boston & Maine railroad, to Lynn via East Saugus, making direct communication with Lynn. The tracks will also be extended from Stonham Centre to Woburn, making direct communications with that town. Mr. John Hill, the former superintendent of the Stonham street railway, will have charge of the new company.

MICHIGAN.

Ann Arbor. The project for establishing an electric street railroad is being considered by the Common Council. The Ann Arbor Street Railway Co. has a capital of \$20,000. Junius A. Beal is president; Edward Duffy, vice-president; Z. E. King, secretary; and T. J. Keech, superintendent.

Detroit. The Dix road, equipped by the Van Depoele Co. is working satisfactorily, and another 25 H. P. motor has been ordered.

Flushing. The Flushing Railroad Company has been incorporated. Capital stock, \$50,000. Daniel Cotcher, O. F. Clarke and Brunson Turner, incorporators.

Grand Rapids. The Street Railway Construction Company, of Grand Rapids, has been incorporated. Capital stock, \$25,000. L. H. Withey, J. M. Weston and A. B. Watson, incorporators.

Pont Huron. The following is the text of the amended ordinance of the Port Huron Railroad Co.: The cars to be used on said railway shall be drawn by animals, or they may be propelled by electric motors, and for such purpose said company may erect such poles as are necessary along the sides of streets, and may stretch wires across the streets and string or suspend wires therefrom over the length of their line, above their track. Cars shall be drawn or propelled at a rate of speed not exceeding six miles an hour, and shall be run as often as public convenience shall require, and shall run for at least fourteen hours every day from the 15th of April to the 15th of October, and at least twelve hours every day from the 15th day of October to the 15th day of April. The rate of fare for each person on any one route shall not exceed five cents, and the whole length of road authorized by ordinance shall be deemed one route; provided, however, that when cars or carriages are hired for specific purpose or time, the rate herein fixed shall not apply.

MINNESOTA.

Minneapolis. The City Council has passed an ordinance extending the limit for steam power for three years, one year in which to find a substitute for steam, and two years more in which to get a cable line in operation. The limit is November, 1889.

St. Paul. The St. Paul Street Railroad Co. has been granted an ordinance for the running of a cable line from the Seven Corners to Victoria street by way of Ramsey street, Oakland street and Grand avenue; also for a motor line from Victoria street along Grand, Macalister, Leslie and Cleveland avenues to the river; to be completed by November, 1887, and November, 1889. Five-cent fare, with three-cent fare between 6 and 7 a. m., and 5 and 6 p. m. The clause for the electric motors was struck out by the aldermen.

MISSOURI.

Kansas City. The Inter-State Elevated Railroad was formally opened for traffic on October 17, and eight trains per day are now running. The line is about 3½ miles long and is built of pin-connected steel trusses about 50 feet span, resting on wrought iron columns. There are no cross-ties, the rails resting on oak blocks 4 inches square placed between a pair of channel irons, these irons acting as guard rails. The steepest grade is about 3 per cent. The structure was built by the Edge Moor Iron Co., Wilmington, Del. The cars are about 30 feet long and seat 40 persons; the motors weigh 15 tons and burn coke. Work was commenced in the summer of 1885, and after being stopped by injunctions was recommenced last spring. The cost is stated to have been \$400,000. D. M. Edgerton is president, and Robert Gillham, chief engineer. Mr. Gillham was the engineer of the Kansas City Cable Railroad.

The contract for the equipment of the new cable railroad has been awarded to the Laclede Car Co., St. Louis, and the Pullman Car Co., Chicago, Ill. All the grips will be built by the Laclede Car Co.

A franchise is being petitioned for for a cable or electric road on Prospect avenue, from Ninth street to the southern city limits. More than half the frontage on the street has been signed for, and work will begin as soon as the franchise has been granted. W. H. Knott, T. J. Green and O. C. Day are interested.

The Metropolitan Street Railroad Co. has obtained its cable franchise for the continuation of the Fifth street line. Watson J. Ferry, Gen. C. W. Blair and Col. C. F. Morse are among those interested.

The Metropolitan Street Railway Co. (Col. C. F. Morse, pres) has purchased the Rosedale street railroad for \$150,000. The Rosedale line runs from Ninth and Main street to the Southwest boulevard, and on the boulevard to the State line. The improvements which were contemplated by the

Rosedale company will be carried out by the Metropolitan, viz., the laying of a double track on the boulevard—an ordinance permitting the same having already been passed and approved. There are also enough improvements on their other lines to keep the Metropolitan busy. This company has now all the street car lines of Kansas City practically under its control, with the exception of the Ninth street cable system. The Metropolitan system proper includes the Wyandotte and stock yards lines, now being converted into a cable road; the Independence avenue, the Twelfth street, the Broadway and Eighteenth street lines; and the individual members of the Metropolitan company also own about two-thirds of the stock of the Grand avenue line and the Fifteenth street cable road, which are now being built. The company owns \$500,000 of the \$800,000 stock of the Grand avenue and Fifteenth street company. It cost \$1,050,000 to purchase the stock of the Corrigan company. And the completion of the Fifth and Twelfth street cable lines will cost \$1,000,000, so that the Metropolitan system will cost in all \$2,700,000.

A contract has been made between the Metropolitan company and property owners along the line to extend the Fifteenth street cable road one-half mile beyond the belt line road and to the east line of Kensington addition, and the road is to be in operation the entire length by March 1. Ground has been donated and a large, handsome brick building, 258x190 feet, for car house, is to be erected at once. The work on the line is progressing rapidly and the iron is almost all on the ground.

St. Louis. Grand avenue is "a bone of contention" between President Julius S. Walsh (Citizen's Railway Co.) and the Shaw's Garden, Tower Grove and Fair Ground Railway. Mr. Walsh will be victorious no doubt. He has contemplated the proposed extension over Grand avenue for some time, but waited for the completion of the bridge before making formal application.

NEW JERSEY.

Bayonne. The extension of the Jersey City and Bergen Railway, to Bayonne, was formally opened Nov. 4th, "the finishing touches" having been given to the new bridge over Morris Canal the previous day. The terminus is on First street at the foot of Avenue R, Bergen Point, the length of the extension being four miles. The fare from the Jersey City ferry to Bergen Point will remain the same as it now is to Greenville—5 cents—and passengers for Bayonne and Bergen Point will be transferred at the stables in Greenville. The route of the Greenville cars is down Grand street to Washington, and through York street to the ferry. Next summer the company expect to run through open cars from the ferry to Bergen Point, a distance of about eight miles.

Jersey City. The Jersey City & Bayonne Horse Railroad Co. will erect a new depot at Bayonne. The superintendent is Thomas M. Sayre.

The horse distemper made its appearance recently in the stables of the North Hudson Horse Railroad Co. at Union Hill; over a dozen horses have died within a week.

The New Jersey Railway Construction Company has awarded a large contract, to the Key Stone Bridge Company, of Pittsburgh, for an elevated railroad in Jersey City which will be three miles long. The cost of the construction will be \$2,000,000 and the cost of the tools to be used, will amount to \$10,000.

The North Hudson Cable Railroad Co. has been granted permission to continue its tracks on the city horse car line to the Fourteenth-street ferry.

Newark. An electric street railroad will probably be established here very soon.

Orange. The ordinance permitting the Orange Cross Town & Orange Valley Horse Car Co. to operate its lines by electricity has not been granted. The company propose to have a wire suspended over the center of the street from cross-wires attached to poles on the curbs. It has canvassed some very lively scenes at council meetings.

NEW YORK.

Brooklyn. Mayor Whitney has signed the franchise authorizing the Atlantic Avenue R. R. Co. to convert certain of its lines to the cable system. The route is from Fulton ferry to the city line, along Fulton, Front, Washington, and other streets to Park avenue, Broadway, Park, Melrose, Jefferson, and other streets and Central avenue. The system will first be tried on Park avenue from Vanderbilt to Broadway, and should it prove a failure the scheme will be dropped. T. L. Johnson and E. I. Du Pont are the contractors, and are pushing the work forward.

At the recent meeting of the Brooklyn & Coney Island R. R. Co. (Smith street line) the following directors were elected: William Marshall, David S. Arnott, John Williams, George W. Chauncey, John S. Ellis, Stephen H. Hermins, William Johnston, Edward Titus, S. Burling, E. J. Dennison, David B. Baylis, Michael Chauncey and Gen. James Jourdan. The company will extend its line from the city line to the shore and will sell some of its land at Coney Island. A mechanical motor is contemplated, and steam, electric, petroleum or caustic soda motors will be experimented with.

The Brooklyn Cable Company of Brooklyn has been incorporated. Capital stock, \$500,000. Thomas L. Johnson, L. A. Russell, Albert L. Johnson (Cleveland, O.), A. J. Du Pont (Wilmington, Del.), Arthur J. Moham (Johnstown, Pa.), Philip R. Voorhes (70, 5th avenue) and Henry C. Evans (New York City), incorporators. The company has filed notice of its purpose to construct a cable extension from Park avenue and Broadway to the city line at Evergreen's cemetery in one direction and to Fulton ferry in the other. The total length of line will be 9¼ miles.

The Bushwick Railroad Co. has elected the following officers: President, William H. Husted; Vice President, Edwin Beers; Secretary and Treasurer, S. D. Hollowell; Superintendent, William N. Morrison.

The recent labor dissatisfaction, on the De Kalb Ave. line of the Brooklyn City and Newton Railroad Company has been smoothed down

and explained away by the president's able letter in the *Brooklyn Eagle* (Nov. 16), showing that the officers of the road are not hard task masters. The annual report of that and other Brooklyn street railroads have been passed; and therefrom we glean the following tabulated information:

| NAME OF RAILWAY. | Cost of Road and Equipment. | Miles operated. | Gross Receipts. | Net Income. |
|--|-----------------------------|-----------------|-----------------|-------------|
| Brooklyn City & Newtown. (Chartered May 22, 1860.) | \$1,611,34 88 | 12.65 | \$14,800 46 | \$2,865 46 |
| Brooklyn & Rockaway Bch | 804,091 37 | 3½ | 1,925 99 | 9,051 66 |
| Brooklyn Cross Town.... (Chartered April 30, 1872.) | 587,614 65 | 16 | 19,025 02 | 2,196 21 |
| Coney Island & Brooklyn. (Chartered Dec. 10, 1860.) | 844,262 66 | 16.95 | 23,209 06 | 16,859 84 |
| Grand Street & Newtown. (Chartered Aug. 18, 1860.) | 327,772 56 | 13 | 17,566 07 | 13,404 24 |
| Jamaica and Brooklyn.... (Consolidated Feb. 23, '80.) | 197,430 00 | 8.25 | 12,647 40 | 1,147 51 |

Against the balance sheet net deficit of \$1,147.51 shown in the Jamaica and Brooklyn Road Company's report there is \$103.27 cash on hand. The length of track given for this and other roads in the table includes sidings. The Jamaica's running track is just six miles long (single), and there is a second track 2½ miles long. This company has but 37 horses, 11 cars, and 14 employes (on an average), but they carried 133,900 passengers during the year. The account of their preferred stock is kept separate, since the original horse railroad was sold under foreclosure in 1880.

Coaling. A street railroad will soon be constructed at this place. It is understood that Chrystie and Janney Bankers, of New York, will have the placing of the bonds.

Far Rockaway. An electric railroad is to be built to connect Far Rockaway, the Isle of Wright and Cedarhurst.

Glens Falls. The Glens Falls, Sandy Hill & Fort Edward Street Railroad Co. has ordered four pairs of sleighs, to be used under their cars when necessary during the winter.

Greenbush. All the conductors on the street railroad have been dismissed and only bob-tail cars are now used.

Ithaca. The Ithaca Street Railroad Co. has obtained the necessary consents from property owners. Hon. J. H. Selkirk has been instrumental in helping the work. D. F. Van Vleet is interested.

Lancaster. The Select Council have ordered that the East End Passenger Railroad Co. must lay flat rails, 4 inches wide. The contract has been awarded to Wm. Wharton, Jr. & Co., of Philadelphia; there will be about 1¼ miles of track and connection will be made with the Lancaster City Railroad. The stringers will be 7 by 5 inches and the ties 4 by 6 inches. For track laying Thos. C. Wiley bid 23½ cents, making a total of over \$1,600; Messrs. Stauffer & Hinden were awarded the contract at \$1,040.

Lockport. The construction of the first street railroad was commenced October 4th; the contractor is T. W. Harris, Exchange Place, Boston; the line is laid with 42-pound rails on pine stringers and cross-ties, wrought iron knees are used and gauge rods every 10 feet. The president of the company is John Hodge, of Lockport.

Long Island City is to have a street railway by next summer. The Riker Avenue and Sandford's Point Railway Co. are laying two miles of track, 4 feet 8½ inch gauge, with 47-pound steel rails. Oscar F. Steins, secretary, 109 E. 14th street, New York.

New York. The Twenty-third Street Railway Company has made its first annual report to Controller Loew of its gross receipts from passengers riding on its cars in Bleeker street and Broadway, for the purpose of showing the sum due to the city from 3 per cent on all receipts from passengers carried in Broadway, in accordance with the terms of the franchise granted by the Board of Aldermen to the Broadway Surface Railroad Company. The Bleeker Street line is leased to the Twenty-third Street company, which in turn has a lease with the Broadway Company for the privilege of running cars upon it.

The report covers the period from October 16, 1885, to October 1, 1886. The number of passengers carried from the Twenty-third Street Ferry is 5,798,825, giving \$289,941.25 receipts. The number of passengers carried in Broadway is 4,523,797, making the receipts in that case \$226,189.85. Three per cent on this sum gives \$6,785.70, the sum turned into the city treasury. Thus the Bleeker Street line through having Broadway to run on has become a tax-paying road, and 80 per cent of the receipts are a basis for taxation for the city, even though a passenger rides only two rods in Broadway.

The reduction of fare to five cents on the Suburban Rapid Transit Railroad, Nov. 25, gave a great deal of satisfaction to the people of the Annexed District. Although the line is only in operation at present up to One-hundred-and-forty-third-st., it has been patronized by a great many people, notwithstanding the 10-cent fare which has heretofore been charged. The work of extending the line up Third-ave. to One-hundred-and-sixty-fourth-st. is proceeding rapidly. Nearly all the foundations for the pillars have been laid, and the Keystone Bridge Company, which has the contract for the iron work, has got enough of its part done almost to insure the entire extension being in operation by February 1. Passengers on the New Haven branch line to New-Rochelle were transferred Nov. 24 by the Suburban to the Second Avenue Elevated line, for the first time, and seemed pleased with the change.

An electric motor system, it is said, will soon be in operation on the Third Avenue Surface Railway, superseding the horse cars completely above 86th-st.

The cable system on Tenth-ave. is proving a great success. Two distinct cable lines are in progress, one from the East River at One-hundred-and-twenty-fifth-st. to Tenth-ave. and Kingsbridge, and one straight across to the Fort Lee Ferry. They go by steam power and stationary engines, not by electric motors. Experiments are to be made with electric motors, and if satisfactory may be adopted.

Hitherto there is no intention of reducing the fare on the Surface roads to 3 cents. The daily press has brought its influence to bear in that direction. The *Tribune* said: "The reduction of fares on the elevated railroads has made an increase of \$5,617 so far in the average daily receipts. This ought to be a lesson to the surface railroad managers who continue to charge five cents. Since that rate of fare was established there has been an enormous increase in the traffic on the surface roads and a large decrease in the cost of construction and maintenance. But there has been no increase in facilities, no improvement in the cars, and no arrangements for transfer tickets; and even the employes are not so well paid as formerly. As these roads paid nothing for their franchises, and are public institutions, this is a case where the public should certainly get some benefit from the 'increment.'" The *Tribune* might have remembered that the surface street railroads have suffered seriously from the "tie-ups" which forced them to keep their horses in the stables, and that the five-cent fare leaves but a very small margin of profit. The great income is derived from the great number of passengers that make use of the surface cars. And the reduction on the "L" roads have made no appreciable difference therein. The surface cars are still running on the old schedule "and they are pretty full every day."

During November a new electric street car motor has been tested on the Eighth avenue surface road. The car has been brought from Europe, and is the invention of M. Julien, an electrician and a native of Belgium, who came with an assistant to introduce it. The motor was invented some time ago, and it is said that the inventor has succeeded in running his cars, which obtained the first prize at the Antwerp Exhibition, in Paris and Berlin. Three months ago he started a line in Brussels, which is reported to be successful also. The car proper is set on a large iron frame, and the entire structure weighs about four tons. The electricity is stored in eight large cast iron boxes with cells that are filled with lead. The boxes are charged with electricity from the large dynamo in the stable. The boxes are placed on two benches in the stable, one on each side of the track on which the car is standing. The boxes are put into the car through small doors in the lower part of the car that open from under the seats. Underneath the car is fastened a powerful dynamo. The currents are connected by means of two large boxes, one on each platform, which in street-car parlance are called the "horses." The driver manipulates his "horse" by means of a crank, by which he turns a screw connecting the currents generated by the "boxes," and which in turn starts the dynamo which transfers its motion to the axles by a system of pulleys and an endless chain. Ten of these "boxes" properly charged, it is claimed, will run a car for a day. The car can be stopped almost instantly while running at the usual rate of speed, and Superintendent Wilson has expressed perfect satisfaction with the results of the test so far, and says that it is "the most satisfactory thing yet in horse-car electric motors."

The elevated railroads have also resolved to introduce electric motors forthwith on their lines, having experimented with the Sprague motor, which has proved a success. It weighs but a ton, can be placed on a passenger car, runs from twenty-three miles an hour to a snail's pace, and stops a train without breaks. The Sprague system is fully described and illustrated in other parts of this issue.

Mayor Grace was "lectured," Nov. 24, in regard to his signing of the franchise granted to the St. Nicholas Avenue and Crosstown Railroad Company. John A. Beall, counsel for many property-owners along the proposed route, said there was no necessity for the railroad. St. Nicholas avenue would be irreparably damaged as a highway. General Horatio C. King and others followed in the same strain, and said that, in view of the action of the McQuade jury, the Mayor's veto assumed more prominence than ever before.

A syndicate of New York business men have filed a petition to the New York legislature to build and operate six miles of the Enos electric railway system in New York city. The probabilities are that the road will be running inside of one year.

Rochester. The Rochester Street Railroad Co. has been asked by a committee of property-owners to build a new line to the east part of the city. Mr. Barry and Mr. Woodworth are members of the company. The line will probably be built. The company proposes to lay its tracks with girder rails.

Saugerties. Mr. George Harding, the proprietor of the Hotel Kaaterskill, will build a cable railroad from Saugerties to the hotel next spring. The West Shore R. R. Co. will supply the rolling stock.

Staten Island. The Rapid Transit Railroad Company is putting electric clocks and signals along the entire length of its roads, so that automatic signals will be given of the passage of trains, or of caution.

Tonawanda. A street railroad company has been incorporated and subscriptions for stock are being solicited.

Troy. Surveys have been made for a steam railroad from Albion to Sand Lake. Messrs. Averill, New York City, are interested.

The Troy and Averill Park Railroad Co. has been incorporated. Capital stock, \$75,000. Aaron Raymond, Henry T. Cuttee, John Dean, Wm. J. Cannon, Geo. H. Cutter, Frank Johnson, and others, incorporators.

Utica. The Utica, Clinton & Binghamton Railroad Co. will build a street car line through the village of New York Mills. For particulars address R. S. Williams, secretary, Utica, N. Y.

Waverly. A street railroad is to be built between Waverly and Athens. F. M. Grimes, Brooklyn, N. Y., has secured the right of way

in Athens. A few years ago Waverly capitalists contemplated a line from that town to Sayre and Athens, but other parties secured a charter for Sayre and there the matter rested. The new line will not touch Sayre.

NORTH CAROLINA.

Charlotte. The Charlotte Street Railroad Co. will build two miles of road at once. F. W. Dixon, Rome, Ga., is the general manager.

Raleigh. Five miles of the Raleigh street railroad is now in operation, with six cars and thirty mules, and 2½ miles more are being constructed. Gauge, 4 feet 8½ inches. The company has a capital stock of \$25,000. Mr. G. M. Snodgrass is president, and Mr. J. F. Scott, secretary and superintendent.

OHIO.

Cincinnati. The Board of Public Affairs has favorably recommended the ordinance establishing the Vine Street Cable line. The engineer reported a majority of 764 feet of frontage in favor of the line. The surveys thereof have been commenced, and the construction will be pushed forward rapidly, under the supervision of Mr. H. M. Lane, who has been engaged for the purpose by the Cincinnati Street Railroad Co.

Sandusky. The Sandusky Street Railroad Co. proposes to extend its tracks.

Springfield. The Citizen's Street Railroad Co. will construct the line on Plum street; contracts have been let to the Cambria Steel Co. for 56 tons of steel rails and to Stewart & Co., Springfield, for 40,000 feet of oak ties. Work will probably be begun this season. The president, Mr. D. W. Stroud, has recently invited proposals from several builders for eight or ten new open cars.

PENNSYLVANIA.

Chester. An extension of a couple of miles is being constructed by the Chester Street R. R. Co.

Lancaster. The East End Passenger Railroad Co. has been granted an ordinance to build its line on East King street; the company to lay "flat" rails and keep the road in repair. President, James Stewart; Directors, George Hanman, M. F. Steigerwalt, A. D. Rohrer, A. A. Herr, W. B. Middleton and W. A. Heitscher.

Norristown. A movement is on foot to construct a street railway through the borough of Montgomery Cemetery and to the Insane Asylum, Norristown. Henry C. Wentz, is the president of the movement.

Oil City. The Oil City Passenger Railroad Co. has recently been organized to build lines on several streets. The construction will be done under the supervision of the City Engineer.

Philadelphia. The Metropolitan R. R. Co. has been incorporated, with \$2,250,000 capital, to build an underground road, 15 miles long, from Upper Darby to Cheltenham Hills.

A motor car on the Market street cable line was recently so overloaded that a spring was broken; and this caused such pitching on the sharp curves near the 23d street bridge that the car was overturned. None of 75 passengers were hurt.

The Baltimore & Ohio R. R. Co. proposes to run an elevated railroad from the depot at 24th and Chestnut street along Sansom to Broad street.

The Hunter Electric Railroad Co. is preparing a pamphlet on the electric railroads of the world.

Pittsburgh. The Nunnery Hill Inclined Plane Railroad Co. has been incorporated with a capital stock of \$60,000. Charles C. Scaife, treasurer.

The Central Transit Railroad Co. is a new organization working under the charter of the Pittsburgh & East Liberty Street Railroad Co.; only the right of way on the lower part of Fifth avenue has to be obtained.

The ordinance has been passed authorizing the Pittsburgh, Knoxville & St. Clair Street Railroad Co. to lay tracks on certain streets not included in the franchise. The contract of equipment has been let to the Safety Electric Railroad & Power Co., New York City, which operates the Daft patents. The grades are as steep as 750 feet per mile with a 50-foot curve on this grade; overhead and underground conductors will be used. There will be five motor cars of 30 H. P. each; for which a speed of 10 miles per hour is guaranteed. The estimated cost of the road is \$120,000.

Messrs. P. A. B. Widener, William L. Elkins, Jacob Sharp and other street railway agents have purchased the Oakland Street Line in Pittsburgh, with a view to making it a cable road.

Scranton. The cars for the electric street railroad, on the Van Deopelle street, are being built at Fullman, Ill.

Stelton. A company has been organized to build a street railroad to Harrisburg.

RHODE ISLAND.

Valley Falls. The Pawtucket Street Railroad Co. will not lay tracks on the Cumberland side of the Blackstone river until the spring.

Woonsocket. The Woonsocket Street Railway Co. has been organized, with a capital of \$50,000, to build a street railroad. It was intended to operate it by electricity, but base traction has been decided on. One line will run from South Main street to the Monument House, another from the depot of the Providence & Worcester R. R. to Blackstone, Mass., and there will be several branches for hauling freight from the mills.

TENNESSEE.

Columbia. The Columbia Street Railroad Co. (T. Wright, E. C. McDowell, J. T. Crash, E. W. Rucher and J. H. Dews, incorporators), has been granted the exclusive right to build and operate a street railroad with horse or electric traction. The right is granted for 30 years. Work is to be commenced in six months, and the fare is fixed at 5 cents.

Nashville. The Main Street and Linschey Avenue Street Railroad Co. has been incorporated by T. W. Crutcher, E. R. Richardson, H. W. Bottruff and others. The Edgefield and Nashville claims right of way by an old charter on some of the streets to be used by the new company. The E. and N. Co. commenced work, but has been enjoined.

The Public Square and Mount Olivet Street Railroad Co. has been incorporated by A. W. Wilks, Perry Kinnaird, John Kulm and others. The Peoples' Railroad Co. will build a street railroad.

The Main Street and Gallatin Pike Street Railroad Co. has been granted an amended ordinance for right of way.

Several Nashville capitalists have organized the Nashville Marginal Railroad Co., and will construct a belt railroad to extend from the Nashville and Decatur depot to the Charlotte turnpike.

Russville. The Rossville Street Railway Co., of Chattanooga, has been incorporated. J. C. Roberts, S. E. Green and E. B. Warner, incorporators.

TEXAS.

Amarillo. A short line of street railroad, 3 feet 6 inches gauge, is to be built.

El Paso. A street car line is in contemplation from El Paso to Ysleta, a distance of 13 miles, by the El Paso Street Railroad Co., who have now 18 cars, hauled by 40 mules, on their 3¼ miles of new track, 3,700 feet of which consists of the Johnson girder rail.

Houston. The Houston City Street Railway Co. have replaced the stable and car house of one of their lines, which were destroyed by fire last year. And this month they are constructing a new cable and car house for their Glenwood line.

Marshall. Work on the street railroad was commenced October 11, and four miles will be in operation in about three months.

WISCONSIN.

Eau Claire. The new street railroad corporation has men at work straightening and repairing its tracks. New cars will be put on.

Stevens' Point. Stevens' Point will have a new street railway. For further information address Owen Clarke.

Business Notes.

Fred. G. Dietreich, Box 353 Washington, D. C., is the inventor and patentee of the Improved Cable Gripping Device, illustrated on pages 330 and 331 of this number of the GAZETTE.

Martin's Improved Change Belt, which has lately been introduced by Martin & Co., of 13 Park Row, New York, has met with decided favor. The Belt is worn by the driver and takes the place of the metal boxes now in use on the dashboard hand-rail. It is strongly made of russet leather, and the pockets for the envelopes are riveted and each has an independent and secure cover. Messrs Martin & Co. carry a full line of maintenance supplies for street railways and omnibus lines.

All inventors that have invented sand boxes with a pipe and tunnel, have made a mistake, for the reason that damp sand would clog the tunnel and pipe. Railroad managers that are putting on the Reliable make no mistake, because it has neither pipe or tunnel and will run sand, salt or gravel dry or wet.

The contract to build an extension to the Chester Street Passenger Railway of Philadelphia was awarded to William Wharton, Jr. & Co., limited, engineers and railroad contractors, 25th street and Washington avenue, Philadelphia.

Mr. Henry Martin, president of the Mount Auburn Cable Railroad Co., advertises for separate bids for a 1½-inch steel wire cable, 900 cast iron conduit sheaves, two engines of 350 H. P. each, and two sets of cable driving machinery. Bids will be received till December 15.

The Fulton Foundry (Cleveland, O.) have sold and shipped their turntables, during the last few days, to the following companies, viz.: Three to East Harrisburgh Passenger Railway Co.; one to Cedar Rapids and Marion Street Railway Co.; two to Beatrice Street Railway Co.; and two to Port Huron Electric Railway Co.

The Laclde Car Co. has lately shipped street cars to Chattanooga, Tenn., Sheboygan, Wis., and Michigan City, Ind. The company has orders in hand for El Paso and Dallas, Texas, Chicago and Belleville, Ill., Cedar Rapids, Iowa, and Raleigh, N. C.

The Johnson girder rail is used on the new street railway at Des Moines, Iowa. Also on the El Paso Street Railroad.

The Washington street car companies, New Orleans, were made uneasy, the beginning of the past month, by the receipt of a large number of five-cent pieces very bright and new in appearance, but having an old date and worn in places. The inference was that they were counterfeit. Some were sent to Chief Brooks, of the secret service, for examination. He discovered that they were good. They were some that had been in circulation once, but had accumulated in the government vaults. When the demand for small coin got so great, a few weeks since, these were polished up at the Mint and put out.

We really don't see why Chicago wants an elevated railroad. Chicago people generally think themselves pretty well elevated above other folks.—*Boston Post.*

Do not make the mistake that the Reliable Sand Boxes are the ones that have been tried and found to clog, we do not use either pipe or tunnel; we guarantee that these boxes will run anything of a reasonable quality—sand, salt or gravel, that is put in them.

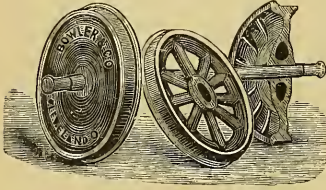

Car Wheels
OF ALL KINDS
FITTED TO AXLES
Street Railroad Turnouts,
Transfer and Turntables,
Barn Drain Troughs and Fur-
niture.
BOWLER & CO.,
14 Winter St., Cleveland, O.

Barnum & Richardson Man'g. Co.,
64 South Jefferson Street, **CHICAGO.**

CHILLED STREET CAR WHEELS

FROM PURE SALISBURY IRON.

Curves, Frogs, Switches, Crossings, Etc.

To Any Pattern.

Light and Heavy CASTINGS for all purposes.

W. H. BARNUM, ALBERT ALLING, WM. E. BEST,
Pres., Lime Rock, Conn. Gen. Mgr. & Treas., Chicago. Sec'y, Chicago.

CHARLES HATHAWAY.

FRANK DeHASS ROBISON.

HATHAWAY & ROBISON,

Street Railroad Contractors and Builders.

HATHAWAY & ROBISON'S PATENT TRANSFER TABLE FOR CAR HOUSES.

Turn Tables, Tram and T Rails, Switch Castings, Spikes, and Street
Railway Material generally on hand.

Office, No. 11 Case Block,

CLEVELAND, OHIO

J. G. BRILL & CO.,

PHILADELPHIA,

Builders of

Railway and Tramway Cars.

COLD MEDAL
For Best Closed Car
AT
CHICAGO EXHIBITION
Of 1883.



GOLD MEDAL
For Best Open Car
AT
NEW ORLEANS EXHIBITION
Of 1885.

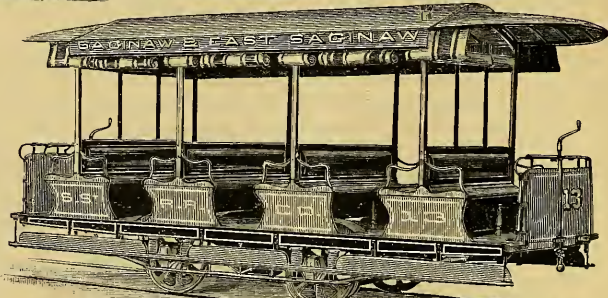
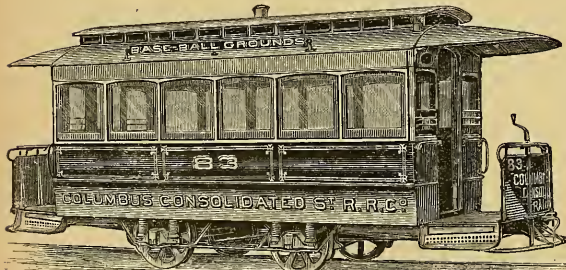



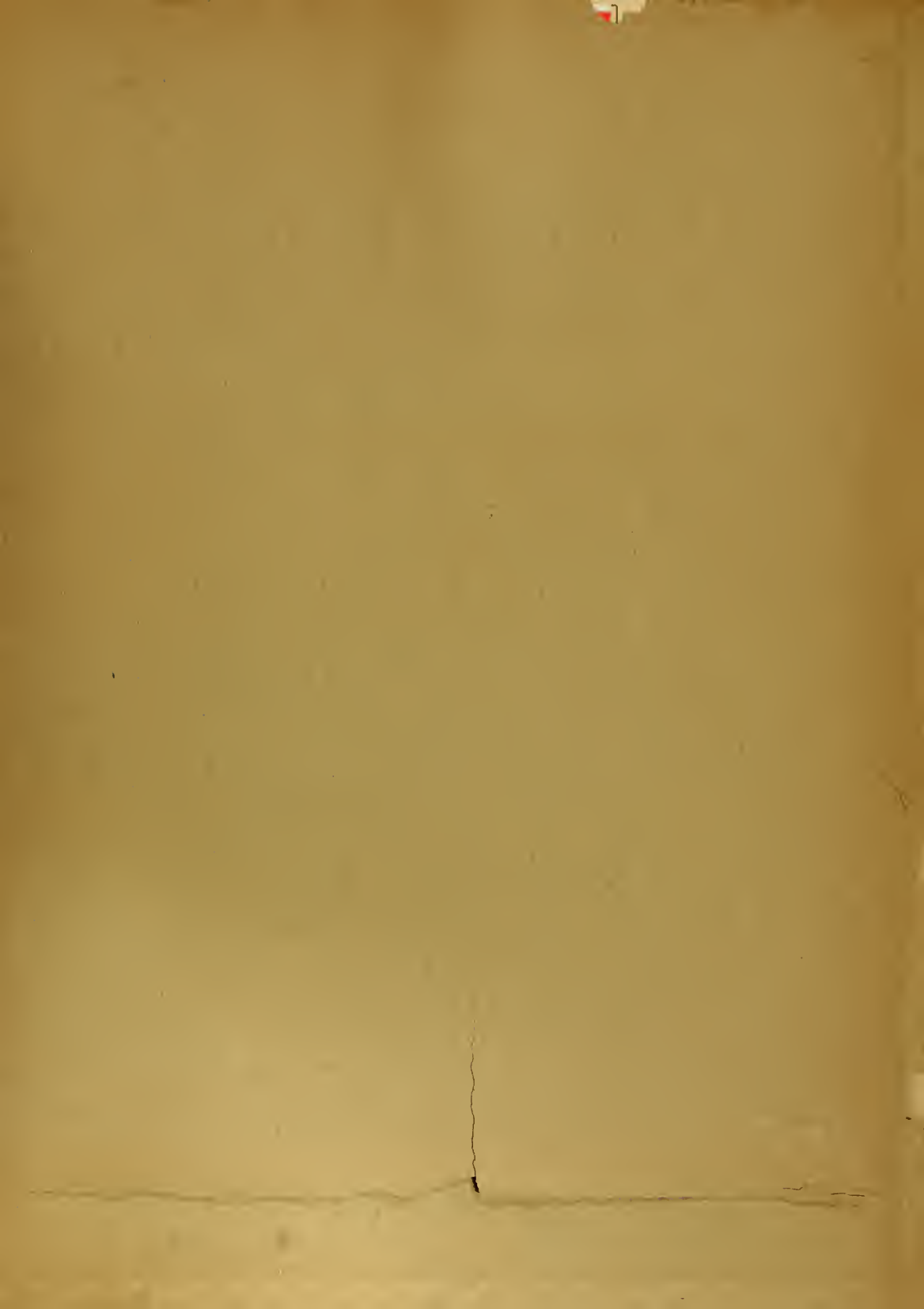

Date Due

| | | |
|--|--|--|
| | | |
|--|--|--|

Lib-26-67

MASSACHUSETTS I

MIT LIBRARIES DUPL

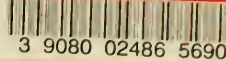

3 9080 02486 5690

RULE ADOPTED BY THE LIBRARY COMMITTEE, MAY 1886

If any book, the property of the Institute, shall be lost or seriously injured, as by any marks or writing made therein, the person to whom it stands charged shall replace it by a new copy, or by a **new set** if it forms a part of a set.

Form 1.53-10.000-12 D/19

TF

126764

.E38

v.1-2

1886-1887

TF

126764

.E38

v.1-2

1886-1887

Street railway gazette.

SIGN this card and present it with book
at the CIRCULATION DESK.

MASSACHUSETTS INSTITUTE OF
TECHNOLOGY LIBRARIES

HUMANITIES LIBRARY

